

TOSHIBA BIPOLAR DIGITAL INTEGRATED CIRCUIT SILICON MONOLITHIC

TD62008AP, TD62008F, TD62008AF

7CH DARLINGTON SINK DRIVER

The TD62008AP / F / AF are high-voltage, high-current darlington drivers comprised of seven NPN darlington pairs. All units feature integral clamp diodes for switching inductive loads and protective diodes against a negative input voltage. The TD62008AP / F / AF are suitable for interfaces from minus and plus dual supply voltage system to plus single supply voltage system.

Applications include relay, hammer, lamp and display (LED) drivers.

Please observe the thermal condition for using.

FEATURES

- Output current (single output) 400 mA (Max)
- High sustaining voltage output 50 V (Min)
- Output clamp diodes
- Protective diodes against a negative input voltage
- Inputs base resistor $R_{IN} = 20\text{ k}\Omega$
- Inputs compatible with 9~15 V PMOS, CMOS.
- Package type-AP : DIP-16 pin
- Package type-F, AF: SOP-16 pin

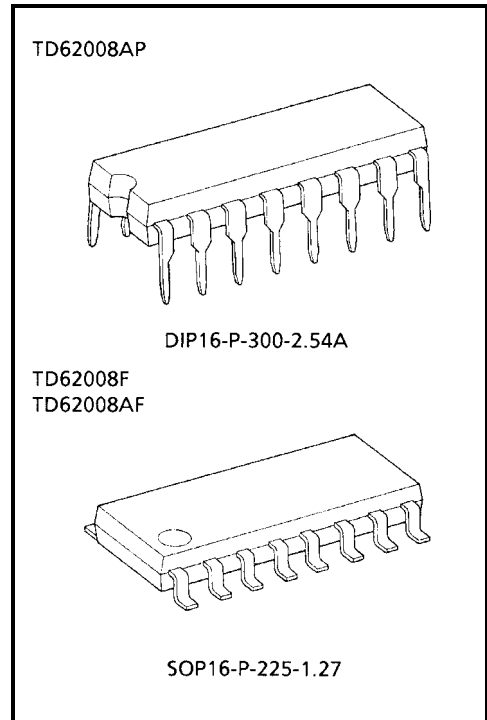

Weight
DIP16-P-300-2.54A : 1.11 g (Typ.)
SOP16-P-225-1.27 : 0.16 g (Typ.)

PIN CONNECTION (TOP VIEW)

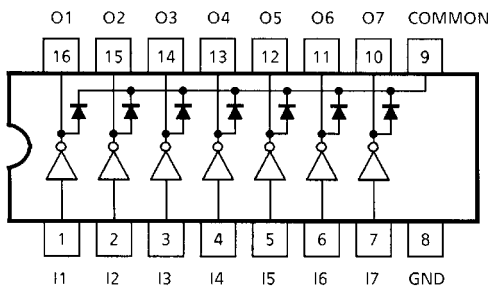

SCHEMATICS (EACH DRIVER)

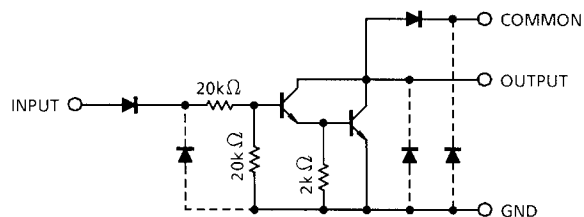

Note: The input and output parasitic diodes cannot be used as clamp diodes.

MAXIMUM RATINGS (Ta = 25°C)

CHARACTERISTIC		SYMBOL	RATING	UNIT
Output Sustaining Voltage	AP / AF	V _{CE (SUS)}	-0.5 ~ 50	V
	F		-0.5 ~ 35	
Output Current		I _{OUT}	400	mA / ch
Input Voltage		V _{IN}	-40 ~ 40	V
Clamp Diode Reverse Voltage	AP / AF	V _R	50	V
	F		35	
Clamp Diode Forward Current		I _F	400	mA
Power Dissipation	AP	P _D	1.47	W
	F / AF		0.625 (Note)	
Operating Temperature		T _{opr}	-40 ~ 85	°C
Storage Temperature		T _{stg}	-55 ~ 150	°C

Note: On Glass Epoxy PCB (30 × 30 × 1.6 mm Cu 50%)

RECOMMENDED OPERATING CONDITIONS (Ta = -40 ~ 85°C)

CHARACTERISTIC		SYMBOL	CONDITION	MIN	TYP.	MAX	UNIT
Output Sustaining Voltage	AP / AF	V _{CE (SUS)}		0	—	50	V
	F			0	—	35	
Output Current	I _{OUT}		DC 1 Circuit, T _{pw} = 25%, Duty = 40%	0	—	400	mA
			T _{pw} = 25 ms, Duty = 10%, 7 Circuits	0	—	200	
Input Voltage		V _{IN}		-35	—	35	V
Clamp Diode Reverse Voltage	AP / AF	V _R		—	—	50	V
	F			—	—	35	
Clamp Diode Forward Current		I _F		—	—	400	mA
Power Dissipation	AP	P _D		—	—	0.52	W
	F / AF		Ta = 85°C (Note)	—	—	0.325	

Note: On Glass Epoxy PCB (30 × 30 × 1.6 mm Cu 50%)

ELECTRICAL CHARACTERISTICS (Ta = 25°C)

CHARACTERISTIC		SYMBOL	TEST CIR-CUIT	TEST CONDITION	MIN	TYP.	MAX	UNIT	
Output Leakage Current	AP / AF	I_{CEX}	1	$V_{OUT} = 50\text{ V}$	—	—	100	μA	
	F			$V_{OUT} = 35\text{ V}$	—	—	100		
Collector-Emitter Saturation Voltage		$V_{CE(sat)}$	2	$I_{OUT} = 400\text{ mA}$	—	1.3	2.4	V	
				$I_{OUT} = 200\text{ mA}$	—	1.0	1.6		
Input Current	"H" Level	$I_{IN(ON)}$	4	$V_{IN} = 18\text{ V}$	—	0.85	1.8	mA	
				$V_{IN} = 35\text{ V}$	—	—	3.8		
	"L" Level	$I_{IN(OFF)}$	4	$V_{IN} = -35\text{ V}$	—	—	-20	μA	
DC Current Transfer Ratio		h_{FE}	3	$V_{CE} = 4\text{ V}, I_{OUT} = 350\text{ mA}$	1000	3000	—		
Clamp Diode Reverse Current		I_R	5	$V_R = 50\text{ V}, V_R = 35\text{ V (Type-F)}$	—	—	100	μA	
Clamp Diode Forward Voltage		V_F	6	$I_F = 400\text{ mA}$	—	1.5	2.4	V	
Turn-On Delay	AP / AF	t_{ON}	7	$C_L = 15\text{ pF}$	$V_{OUT} = 50\text{ V}, R_L = 156\ \Omega$	—	0.1	—	μs
	F				$V_{OUT} = 35\text{ V}, R_L = 110\ \Omega$				
Turn-Off Delay	AP / AF	t_{OFF}			$V_{OUT} = 50\text{ V}, R_L = 156\ \Omega$	—	0.2	—	μs
	F				$V_{OUT} = 35\text{ V}, R_L = 110\ \Omega$				

TEST CIRCUIT

1. I_{CEX}

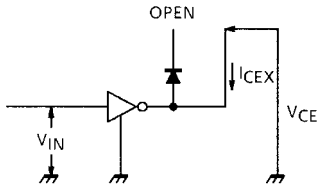

2. $V_{CE(sat)}$

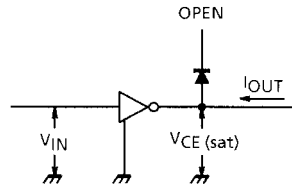

3. h_{FE}

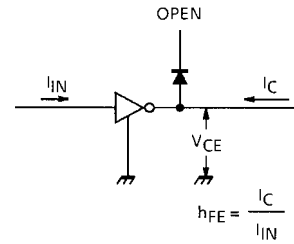

4. $I_{IN(ON)}, I_{IN(OFF)}$

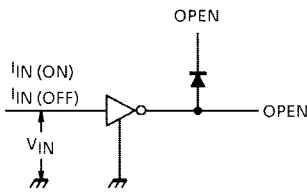

5. I_R

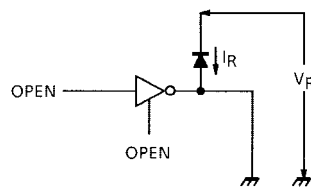

6. V_F

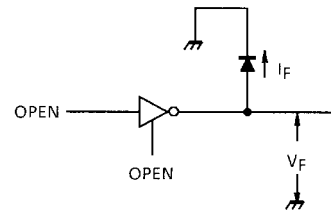

7. t_{ON}, t_{OFF}

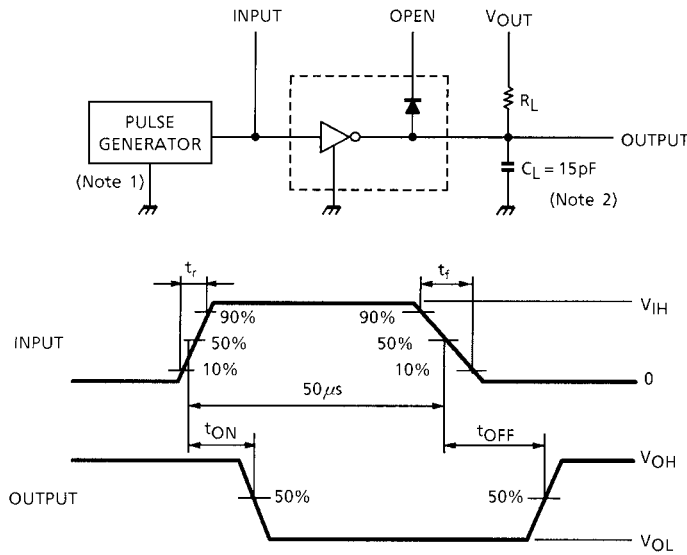

Note 1: Pulse Width 50 μ s
 Duty Cycle 10%
 Output Impedance 50 Ω
 $t_r \leq 5$ ns, $t_f \leq 10$ ns

Note 2: C_L includes probe and jig capacitance

PRECAUTIONS for USING

This IC does not include built-in protection circuits for excess current or overvoltage.

If this IC is subjected to excess current or overvoltage, it may be destroyed.

Hence, the utmost care must be taken when systems which incorporate this IC are designed.

Utmost care is necessary in the design of the output line, COMMON and GND line since IC may be destroyed due to short-circuit between outputs, air contamination fault, or fault by improper grounding.

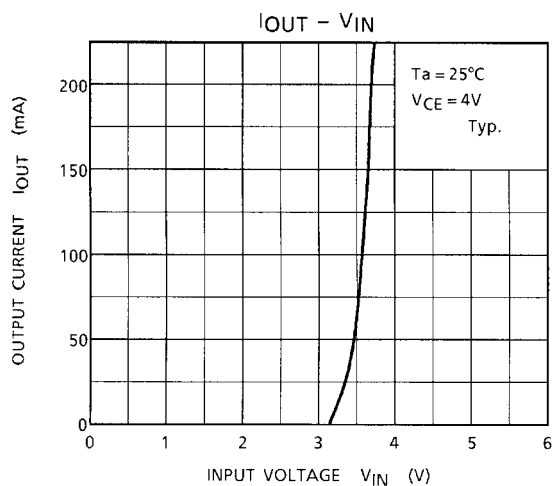
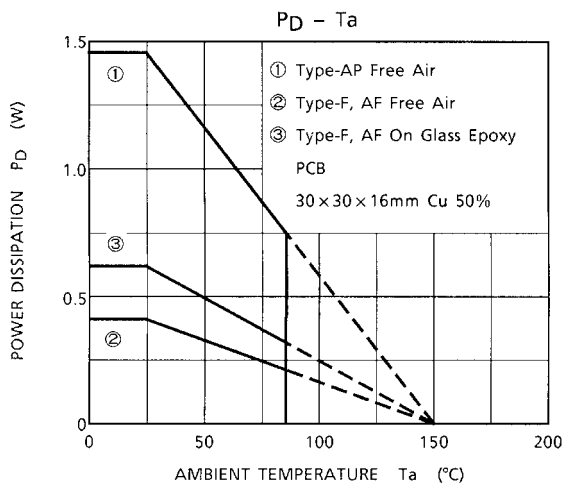
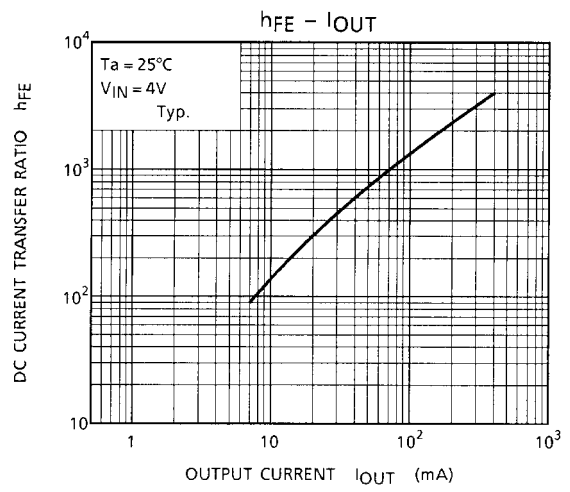
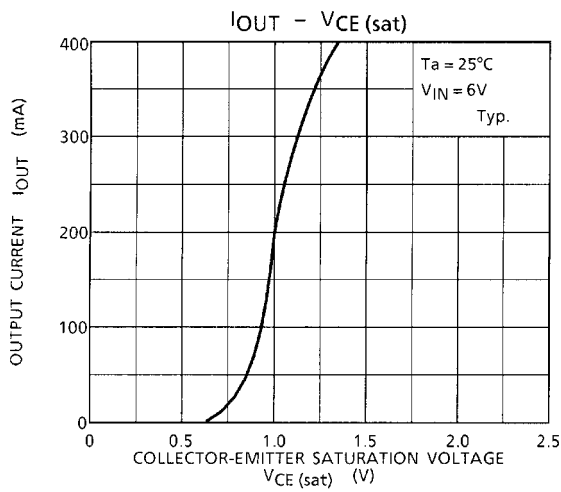
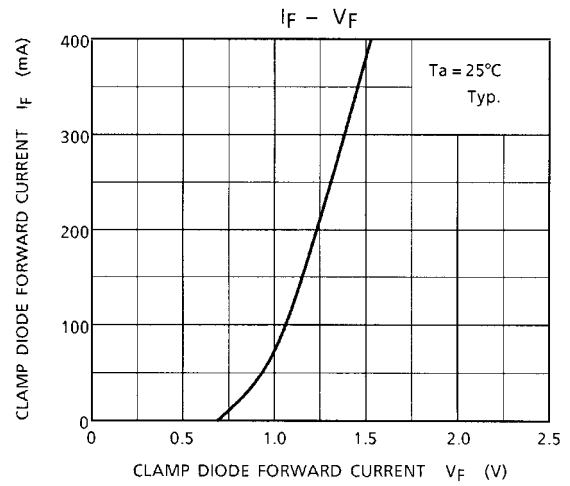
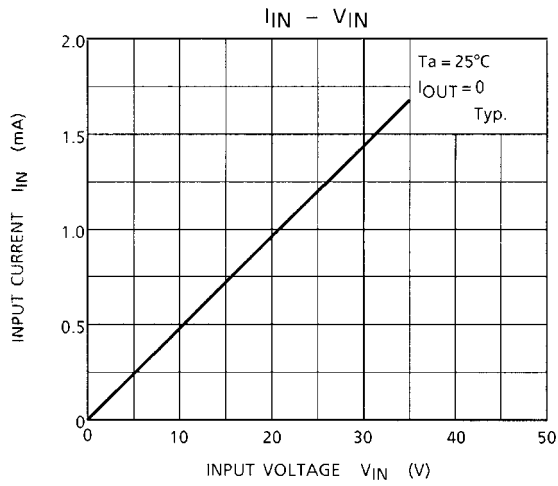

PACKAGE DIMENSIONS

DIP16-P-300-2.54A

Unit : mm

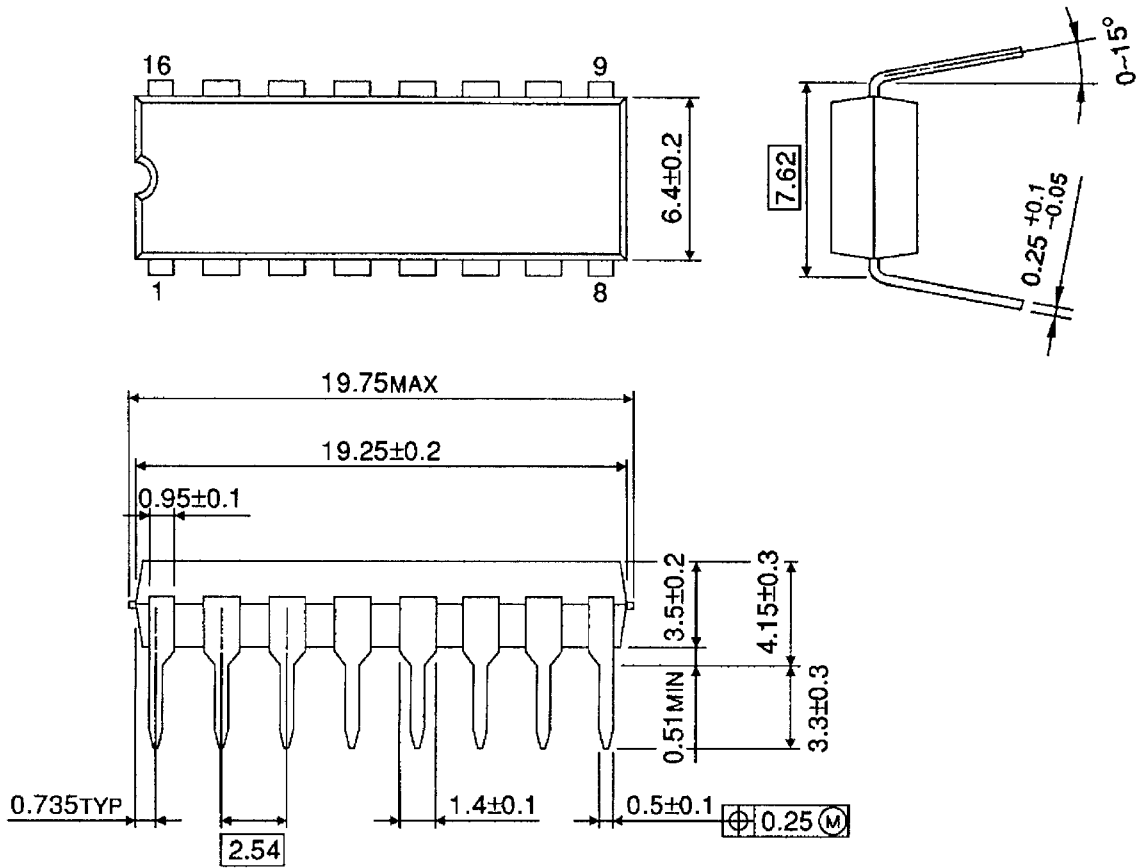

Weight: 1.11 g (Typ.)

PACKAGE DIMENSIONS

SOP16-P-225-1.27

Unit : mm

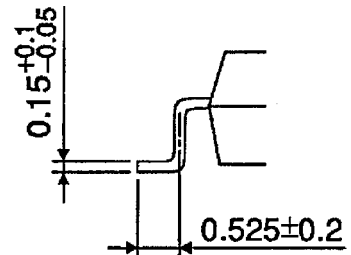
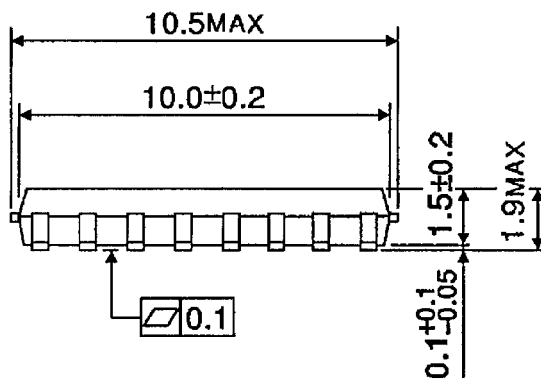
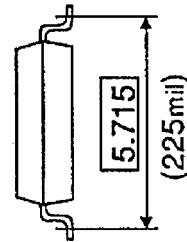
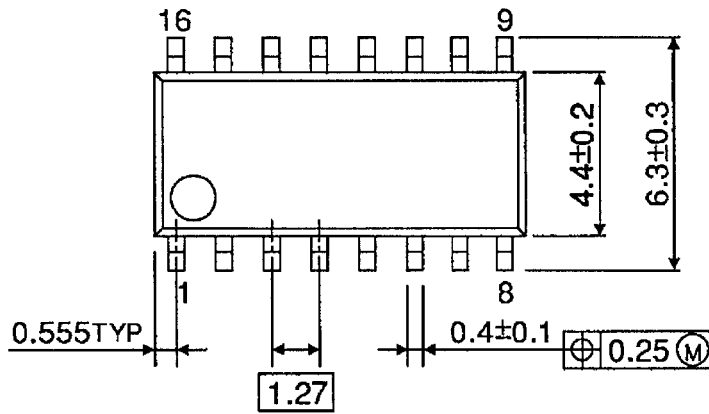

Weight: 0.16 g (Typ.)

RESTRICTIONS ON PRODUCT USE

000707EBA

- TOSHIBA is continually working to improve the quality and reliability of its products. Nevertheless, semiconductor devices in general can malfunction or fail due to their inherent electrical sensitivity and vulnerability to physical stress. It is the responsibility of the buyer, when utilizing TOSHIBA products, to comply with the standards of safety in making a safe design for the entire system, and to avoid situations in which a malfunction or failure of such TOSHIBA products could cause loss of human life, bodily injury or damage to property.
In developing your designs, please ensure that TOSHIBA products are used within specified operating ranges as set forth in the most recent TOSHIBA products specifications. Also, please keep in mind the precautions and conditions set forth in the "Handling Guide for Semiconductor Devices," or "TOSHIBA Semiconductor Reliability Handbook" etc..
- The TOSHIBA products listed in this document are intended for usage in general electronics applications (computer, personal equipment, office equipment, measuring equipment, industrial robotics, domestic appliances, etc.). These TOSHIBA products are neither intended nor warranted for usage in equipment that requires extraordinarily high quality and/or reliability or a malfunction or failure of which may cause loss of human life or bodily injury ("Unintended Usage"). Unintended Usage include atomic energy control instruments, airplane or spaceship instruments, transportation instruments, traffic signal instruments, combustion control instruments, medical instruments, all types of safety devices, etc.. Unintended Usage of TOSHIBA products listed in this document shall be made at the customer's own risk.
- The products described in this document are subject to the foreign exchange and foreign trade laws.
- The information contained herein is presented only as a guide for the applications of our products. No responsibility is assumed by TOSHIBA CORPORATION for any infringements of intellectual property or other rights of the third parties which may result from its use. No license is granted by implication or otherwise under any intellectual property or other rights of TOSHIBA CORPORATION or others.
- The information contained herein is subject to change without notice.