

TOSHIBA BIPOLAR DIGITAL INTEGRATED CIRCUIT SILICON MONOLITHIC

TD62064P,TD62064AP,TD62064F,TD62064AF TD62074P,TD62074AP,TD62074F,TD62074AF

4CH HIGH-CURRENT DARLINGTON SINK DRIVER

The TD62064P / AP / F / AF and TD62074P / AP / F / AF are high-voltage, high-current darlington drivers comprised of four NPN darlington pairs.

All units feature integral clamp diodes for switching inductive loads and all units of TD62074P / AP / F / AF feature uncommitted collectors and emitters for isolated darlington applications.

For proper operation, the substrate (SUB) must be connected to the most negative voltage.

Applications include relay, hammer, lamp and stepping moter drivers.

FEATURES

- Output current (single output) 1.5 A (Max)
- High sustaining voltage output
35 V (Min) (TD62064P / F, 074P / F)
50 V (Min) (TD62064AP / AF, 074AP / AF)
- Output clamp diodes : TD62064P / AP / F / AF
- Isolated darlington array : TD62074P / AP / F / AF
- Input compatible with TTL and 5 V CMOS
- GND and SUB terminal = heat sink
- Package type-P, AP: DIP-16 pin
- Package type-F, AF: HSOP-16 pin

PIN CONNECTION (TOP VIEW)

TD62064P / AP

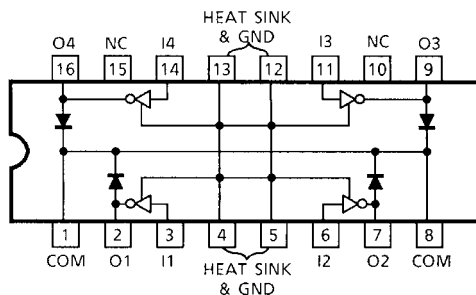

TD62074P / AP

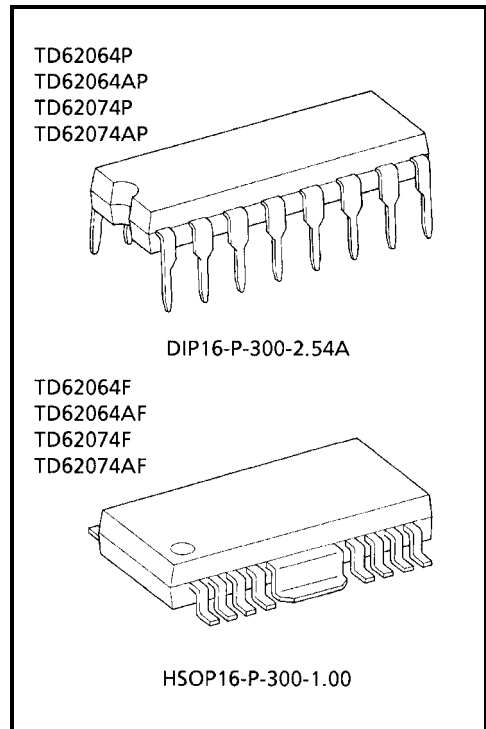
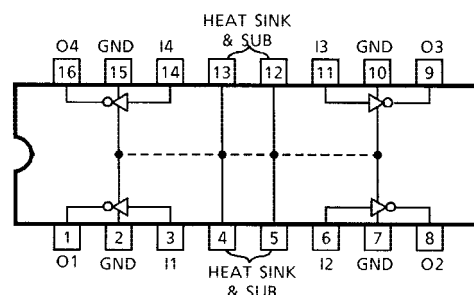

Weight
DIP16-P-300-2.54A : 1.11 g (Typ.)
HSOP16-P-300-1.00 : 0.50 g (Typ.)

TD62064F / AF

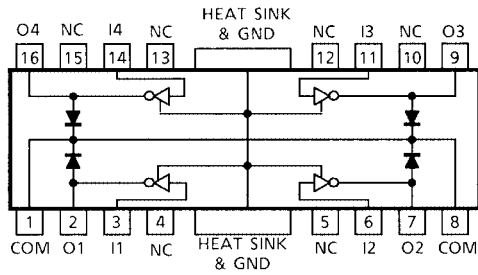

TD62074F / AF

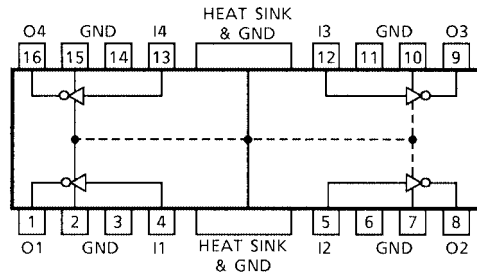

SCHEMATICS (EACH DRIVER)

TD62064P / AP / F / AF

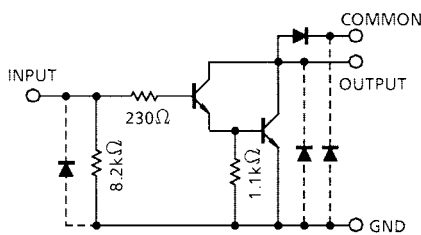

TD62074P / AP / F / AF

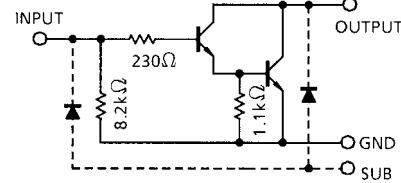

Note: The input and output parasitic diodes cannot be used as clamp diodes.

MAXIMUM RATINGS (Ta = 25°C)

CHARACTERISTIC		SYMBOL	RATING	UNIT
Output Sustaining Voltage	P, F	V _{CE (SUS)}	-0.5~35	V
	AP, AF		-0.5~50	
Output Current		I _{OUT}	1.5	A / ch
Input Current		I _{IN}	50	mA
Input Voltage		V _{IN}	-0.5~17	V
Clamp Diode Reverse Voltage	P, F	V _{R (Note 1)}	35	V
	AP, AF		50	
Clamp Diode Forward Current		I _{F (Note 1)}	1.5	A / ch
Isolated Voltage	P, F	V _{SUB (Note 2)}	35	V
	AP, AF		50	
Power Dissipation	P, AP	P _D	1.47 / 2.7 (Note 3)	W
	F, AF		0.9 / 1.4 (Note 4)	
Operating Temperature		T _{opr}	-40~85	°C
Storage Temperature		T _{stg}	-55~150	°C

Note 1: TD62064P / AP / F / AF

Note 2: TD62074P / AP / F / AF

Note 3: On Glass Epoxy PCB (50 × 50 × 1.6 mm Cu 50%)

Note 4: On Glass Epoxy PCB (60 × 30 × 1.6 mm Cu 30%)

RECOMMENDED OPERATING CONDITIONS (Ta = -40~85°C)

CHARACTERISTIC		SYMBOL	TEST CONDITION	MIN	TYP.	MAX	UNIT
Output Sustaining Voltage	P, F	V _{CE (SUS)}		0	—	35	V
	AP, AF			0	—	50	
Output Current	P, AP (Note 1)	I _{OUT}	DC1 Circuit, Ta = 25°C	0	—	1250	mA / ch
			T _{pw} = 25 ms 4 Circuits T _j = 120°C Ta = 85°C	Duty = 10 %	0	—	
	Duty = 50 %			0	—	390	
	Duty = 10 %			0	—	907	
F, AF (Note 2)	Duty = 50 %	0	—	172			
Input Voltage		V _{IN}		0	—	8	V
	(Output On)	V _{IN (ON)}	I _{OUT} = 1.25 A	2.5	—	8	V
	(Output Off)	V _{IN (OFF)}		0	—	0.4	V
Input Current		I _{IN}		0	—	20	mA
Clamp Diode Reverse Voltage	P, F	V _R	TD62064P / AP / F / AF	0	—	35	V
	AP, AF			0	—	50	
Clamp Diode Forward Current		I _F		—	—	1.25	A
Isolation Voltage	P, F	V _{SUB}	TD62074P / AP / F / AF	—	—	35	V
	AP, AF			—	—	50	
Power Dissipation	P, AP	P _D	Ta = 85°C (Note 1)	—	—	1.4	W
	F, AF		Ta = 85°C (Note 2)	—	—	0.7	

Note 1: On Glass Epoxy PCB (50 × 50 × 1.6 mm Cu 50%)

Note 2: On Glass Epoxy PCB (60 × 30 × 1.6 mm Cu 30%)

ELECTRICAL CHARACTERISTICS (Ta = 25°C)

CHARACTERISTIC	SYMBOL	TEST CIR-CUIT	TEST CONDITION	MIN	TYP.	MAX	UNIT
Output Leakage Current	AP, AF	1	$V_{CE} = 50\text{ V}, T_a = 25^\circ\text{C}$	—	—	50	μA
			$V_{CE} = 50\text{ V}, T_a = 85^\circ\text{C}$	—	—	500	
	P, F		$V_{CE} = 35\text{ V}, T_a = 25^\circ\text{C}$	—	—	50	
			$V_{CE} = 35\text{ V}, T_a = 85^\circ\text{C}$	—	—	500	
Collector-Emitter Saturation Voltage	$V_{CE(sat)}$	2	$I_{OUT} = 1.25\text{ A}, I_{IN} = 2\text{ mA}$	—	—	1.6	V
			$I_{OUT} = 0.75\text{ A}, I_{IN} = 935\text{ }\mu\text{A}$	—	—	1.25	
DC Current Transfer Ratio	h_{FE}	2	$V_{CE} = 2\text{ V}$	$I_{OUT} = 1.0\text{ A}$	—	800	—
				$I_{OUT} = 0.25\text{ A}$	—	1500	
Input Voltage (Output On)	$V_{IN(ON)}$	3	$I_{OUT} = 1.25\text{ A}, I_{IN} = 2\text{ mA}$	—	—	2.4	V
Clamp Diode Leakage Current	AP, AF	4	$V_R = 50\text{ V}, T_a = 25^\circ\text{C}$	—	—	50	μA
			$V_R = 50\text{ V}, T_a = 85^\circ\text{C}$	—	—	100	
	F		$V_R = 35\text{ V}, T_a = 25^\circ\text{C}$	—	—	50	
			$V_R = 35\text{ V}, T_a = 85^\circ\text{C}$	—	—	100	
Clamp Diode Forward Voltage	V_F	5	$I_F = 1.25\text{ A}$	—	—	2	V
Input Capacitance	C_{IN}	6	$V_{IN} = 0\text{ V}, f = 1\text{ MHz}$	—	15	—	pF
Turn-On Delay	P, F	7	$C_L = 15\text{ pF}$	$V_{OUT} = 35\text{ V}, R_L = 29\text{ }\Omega$	—	0.1	μs
	AP, AF			$V_{OUT} = 50\text{ V}, R_L = 42\text{ }\Omega$			
Turn-Off Delay	P, F	$V_{OUT} = 35\text{ V}, R_L = 29\text{ }\Omega$		—	1.0	—	
	AP, AF	$V_{OUT} = 50\text{ V}, R_L = 42\text{ }\Omega$					

TEST CIRCUIT

1. I_{CEX}

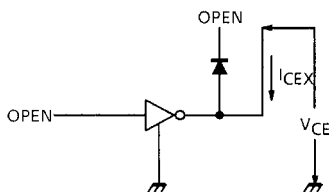

2. $V_{CE(sat)}, h_{FE}$

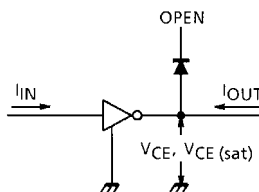

3. $V_{IN(ON)}$

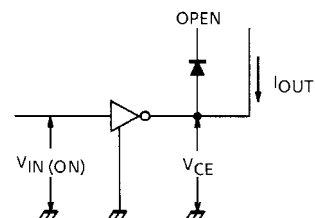

4. I_R

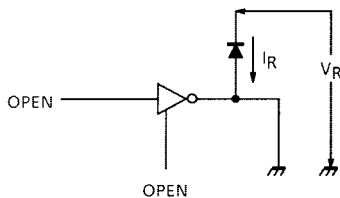

5. V_F

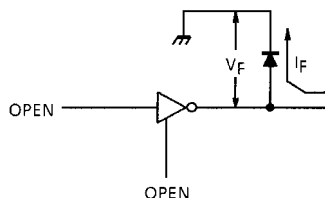

6. C_{IN}

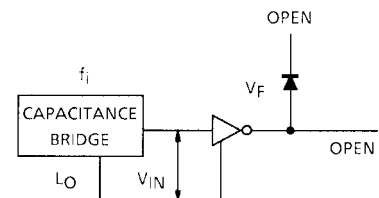

7. t_{ON} , t_{OFF}

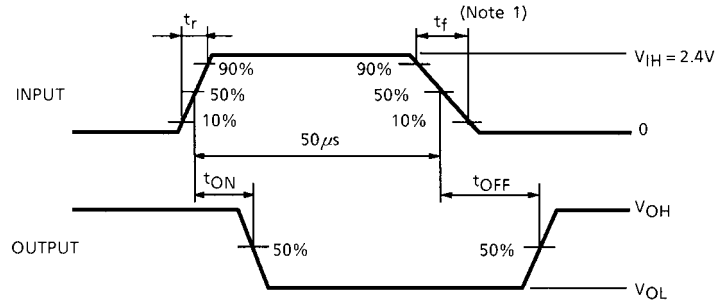
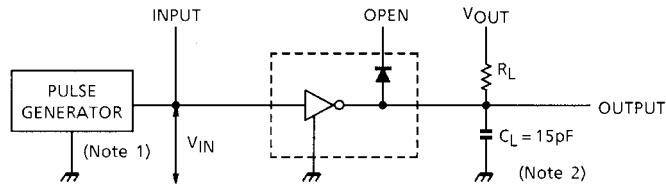

- Note 1: Pulse Width 50 μ s, Duty Cycle 10%
Output Impedance 50 Ω , $t_r \leq 5$ ns, $t_f \leq 10$ ns
- Note 2: C_L includes probe and jig capacitance

PRECAUTIONS for USING

- (1) This IC does not include built-in protection circuits for excess current or overvoltage. If this IC is subjected to excess current or overvoltage, it may be destroyed. Hence, the utmost care must be taken when systems which incorporate this IC are designed. Utmost care is necessary in the design of the output line, COMMON and GND line since IC may be destroyed due to short-circuit between outputs, air contamination fault, or fault by improper grounding.
- (2) When using TD62064P/AP/F/AF to drive an inductive load (such as a motor, solenoid, or relay), Toshiba recommend you use diodes (pins 1 and 8) to absorb the counter electromotive force generated when driving an inductive load.
When using TD62074P/AP/F/AF to drive an inductive load (such as a motor, solenoid, or relay), Toshiba recommend you connect diodes externally to absorb the counter electromotive force generated when driving an inductive load.

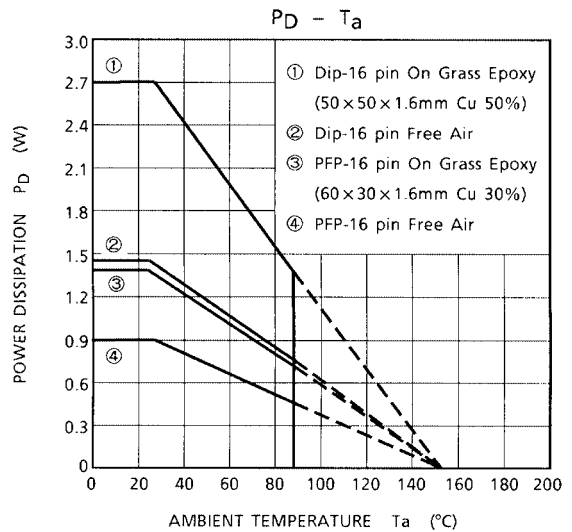
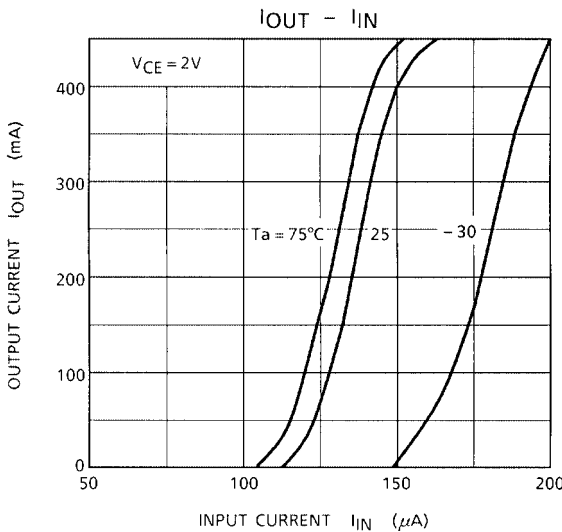
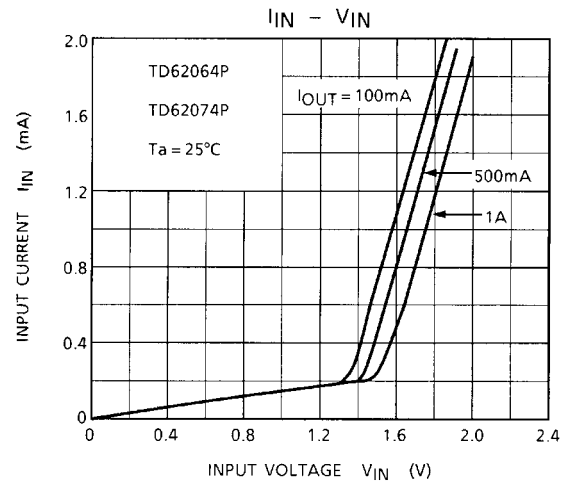
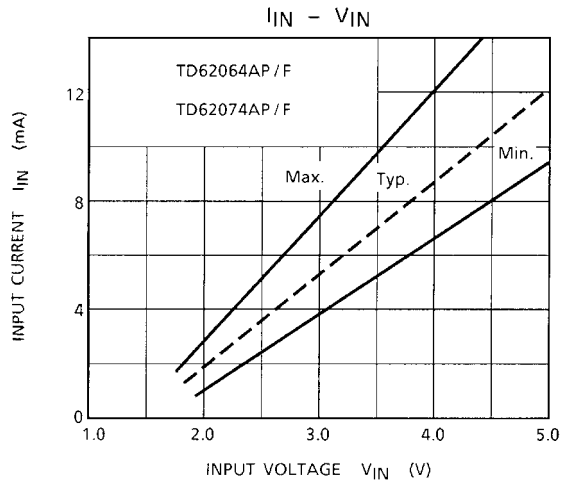
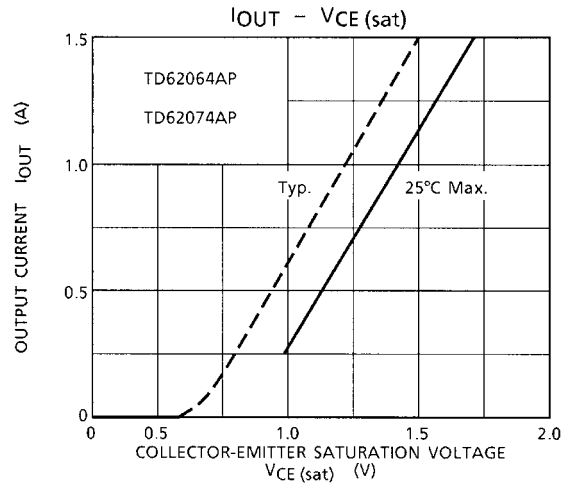
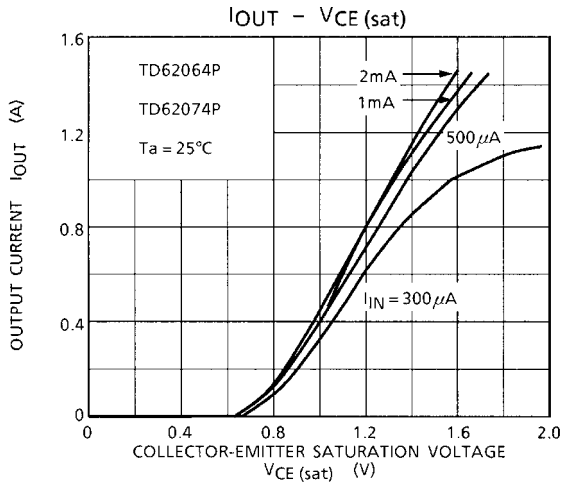

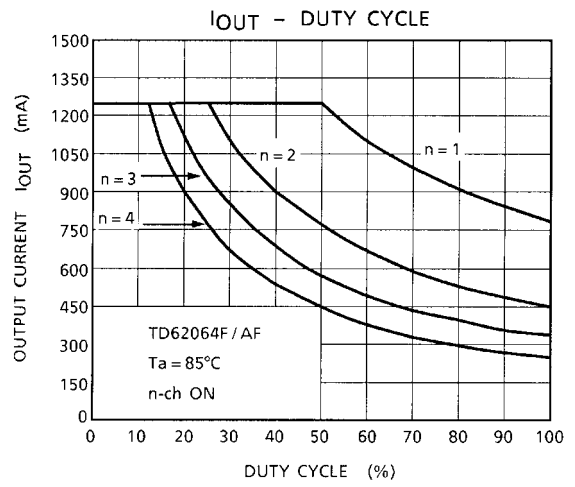
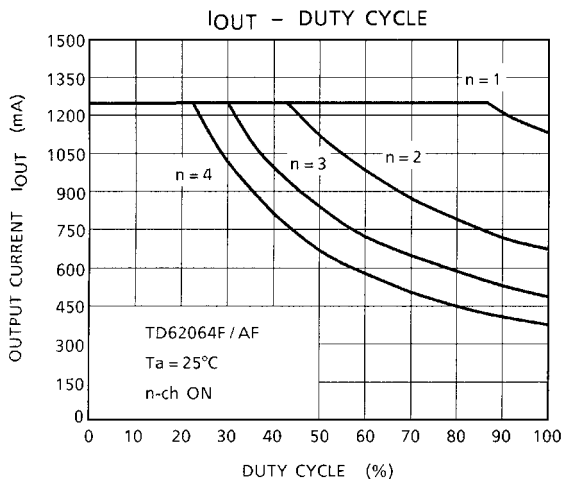
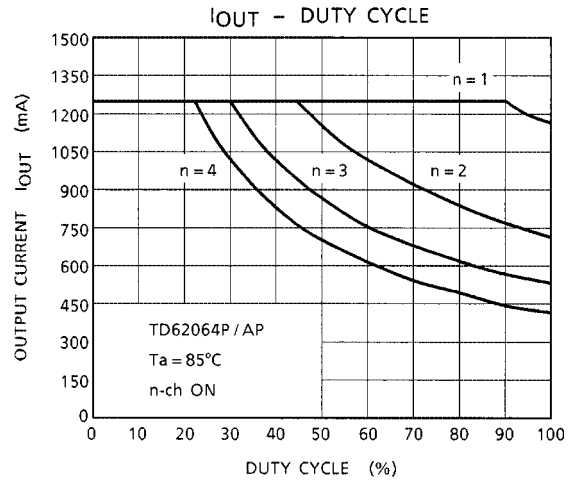
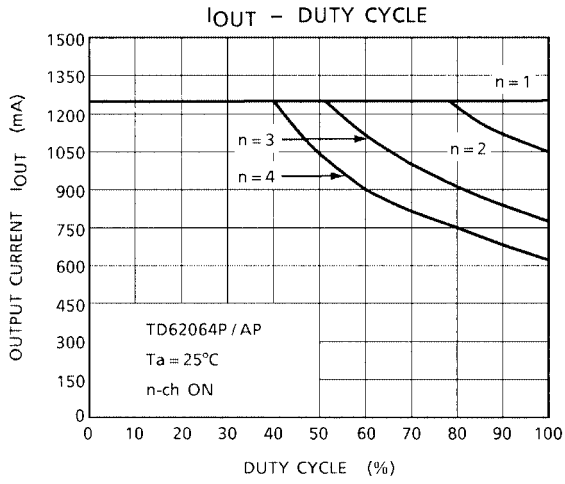

PACKAGE DIMENSIONS

DIP16-P-300-2.54A

Unit : mm

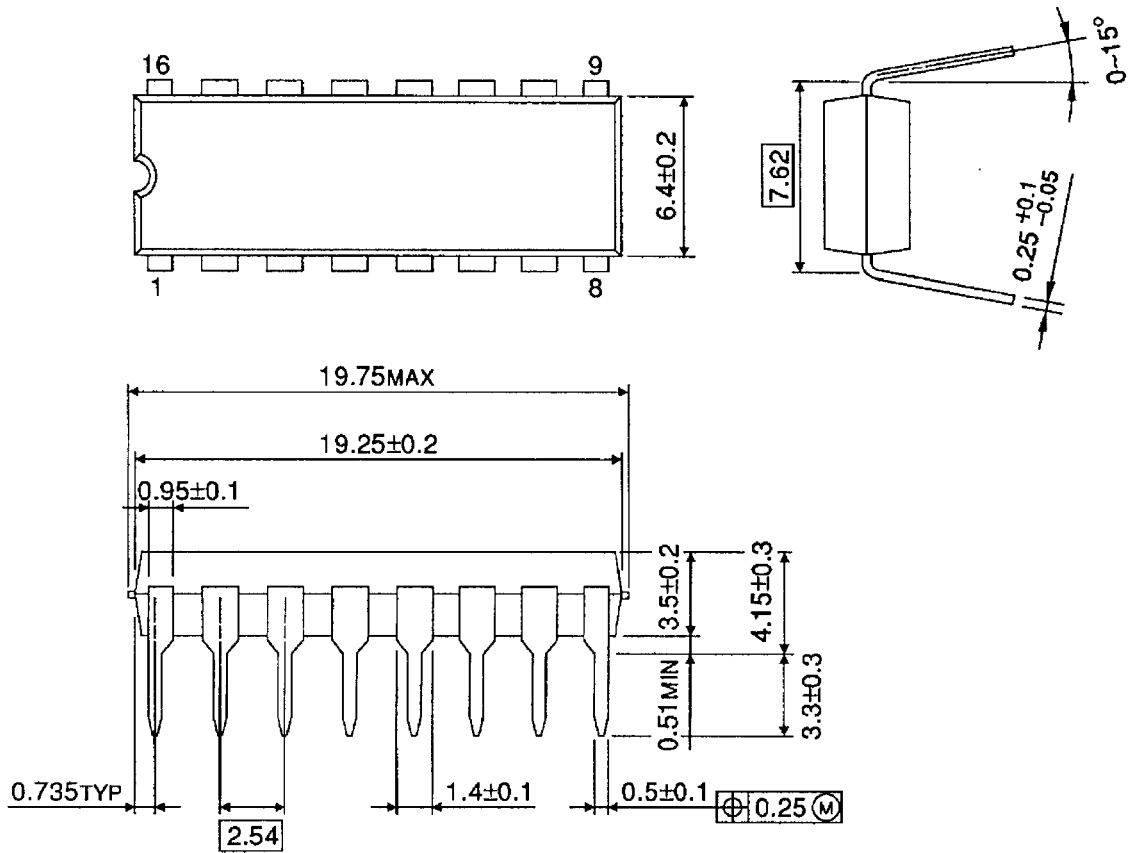

Weight: 1.11 g (Typ.)

PACKAGE DIMENSIONS

HSOP16-P-300-1.00

Unit : mm

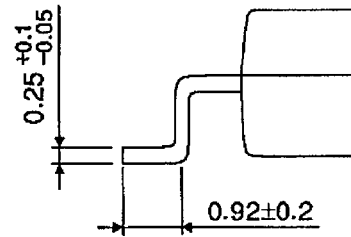
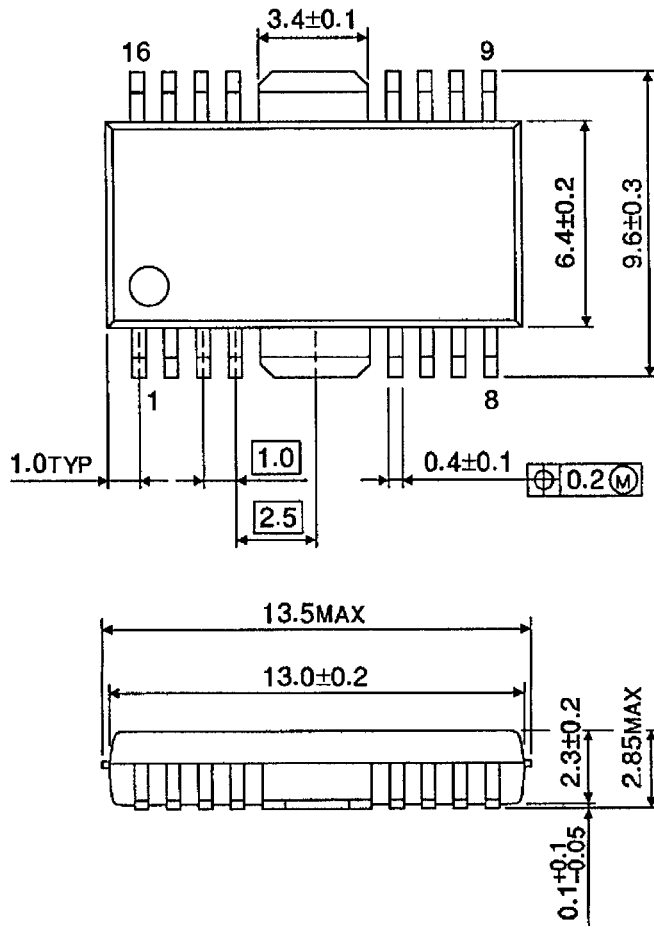

Weight: 0.50 g (Typ.)

RESTRICTIONS ON PRODUCT USE

000707EBA

- TOSHIBA is continually working to improve the quality and reliability of its products. Nevertheless, semiconductor devices in general can malfunction or fail due to their inherent electrical sensitivity and vulnerability to physical stress. It is the responsibility of the buyer, when utilizing TOSHIBA products, to comply with the standards of safety in making a safe design for the entire system, and to avoid situations in which a malfunction or failure of such TOSHIBA products could cause loss of human life, bodily injury or damage to property.
In developing your designs, please ensure that TOSHIBA products are used within specified operating ranges as set forth in the most recent TOSHIBA products specifications. Also, please keep in mind the precautions and conditions set forth in the "Handling Guide for Semiconductor Devices," or "TOSHIBA Semiconductor Reliability Handbook" etc..
- The TOSHIBA products listed in this document are intended for usage in general electronics applications (computer, personal equipment, office equipment, measuring equipment, industrial robotics, domestic appliances, etc.). These TOSHIBA products are neither intended nor warranted for usage in equipment that requires extraordinarily high quality and/or reliability or a malfunction or failure of which may cause loss of human life or bodily injury ("Unintended Usage"). Unintended Usage include atomic energy control instruments, airplane or spaceship instruments, transportation instruments, traffic signal instruments, combustion control instruments, medical instruments, all types of safety devices, etc.. Unintended Usage of TOSHIBA products listed in this document shall be made at the customer's own risk.
- The products described in this document are subject to the foreign exchange and foreign trade laws.
- The information contained herein is presented only as a guide for the applications of our products. No responsibility is assumed by TOSHIBA CORPORATION for any infringements of intellectual property or other rights of the third parties which may result from its use. No license is granted by implication or otherwise under any intellectual property or other rights of TOSHIBA CORPORATION or others.
- The information contained herein is subject to change without notice.