

TOSHIBA BIPOLAR DIGITAL INTEGRATED CIRCUIT SILICON MONOLITHIC

TD62101P,TD62101F,TD62103P,TD62103F TD62104P,TD62104F,TD62105P,TD62105F

7CH DARLINGTON SINK DRIVER

The TD62101P / F series are high-voltage, high-current darlington drivers comprised of seven NPN darlington pairs.

FEATURES

- Output current (single output) : 500 mA (max)
- High sustaining voltage output: 25 V (min)
- Inputs compatible with various types of logic.
- Package type-P : DIP-16 pin.
- Package type-F : SOP-16 pin.

TYPE	INPUT BASE RESISTOR	DESIGNATION
TD62101P / F	External	General Purpose
TD62103P / F	2.7kΩ	TTL, 5 V CMOS
TD62104P / F	10.5kΩ	6~15 V CMOS, PMOS
TD62105P / F	20kΩ	12~25 V CMOS, PMOS

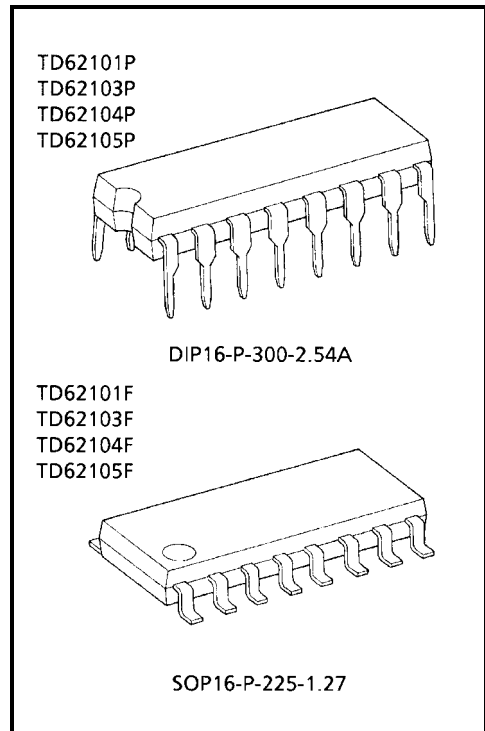

Weight
 DIP16-P-300-2.54A : 1.11 g (typ.)
 SOP16-P-225-1.27 : 0.16 g (typ.)

PIN CONNECTION (TOP VIEW)

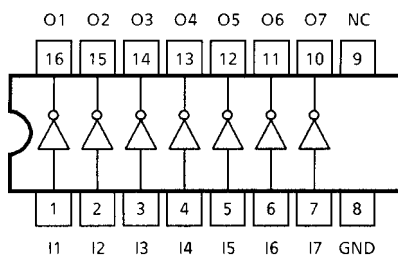

SCHEMATICS (EACH DRIVER)

TD62101P / F

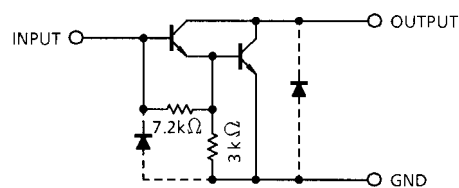

Note: The input and output parasitic diodes cannot be used as clamp diodes.

SCHEMATICS (EACH DRIVER)

TD62103P / F

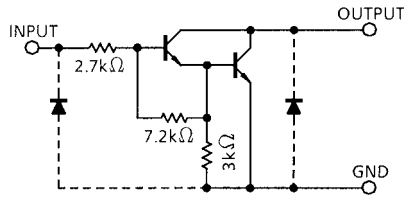

TD62104P / F

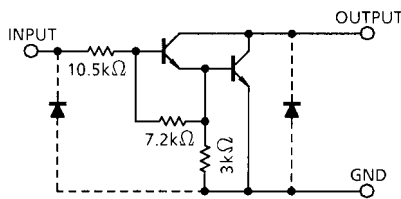

TD62105P / F

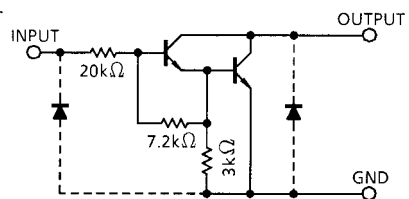

Note: The input and output parasitic diodes cannot be used as clamp diodes.

MAXIMUM RATINGS (Ta = 25°C)

CHARACTERISTICS		SYMBOL	RATING	UNIT
Output Sustaining Voltage		$V_{CE(SUS)}$	-0.5~25	V
Output Current		I_{OUT}	500	mA / ch
Input Voltage		V_{IN} (Note 1)	-0.5~30	V
Input Current		I_{IN} (Note 2)	25	mA
Power Dissipation	P	P_D	1.0	W
	F		0.625 (Note 3)	
Operating Temperature	P	T_{opr}	-30~75	°C
	F		-40~85	
Storage Temperature		T_{stg}	-55~150	°C

Note 1: Except TD62101P / F

Note 2: Only TD62101P / F

Note 3: On Glass Epoxy PCB (30 × 30 × 1.6 mm Cu 50%)

RECOMMENDED OPERATING CONDITIONS (Ta = -40~85°C and Ta = -30~75°C for only Type-P)

CHARACTERISTIC		SYMBOL	CONDITION	MIN	TYP.	MAX	UNIT
Output Sustaining Voltage		$V_{CE(SUS)}$		0	—	25	V
Output Current		I_{OUT}	DC 1 Circuit	0	—	350	mA / ch
			$T_{pw} = 25$ ms, Duty = 10% 7 Circuits, Ta = 85°C, Tj = 120°C	0	—	300	
Input Voltage	Except TD62101P / F	V_{IN}		0	—	20	V
Input Current	Only TD62101P / F	I_{IN}		—	—	10	mA
Power Dissipation	P	P_D		—	—	0.44	W
	F		(Note)	—	—	0.325	

Note: On Glass Epoxy PCB (30 × 30 × 1.6 mm Cu 50%)

ELECTRICAL CHARACTERISTICS (Ta = 25°C)

CHARACTERISTIC		SYMBOL	TEST CIR-CUIT	TEST CONDITION	MIN	TYP.	MAX	UNIT			
Output Leakage Current	P	I _{CEX}	1	V _{CE} = 25 V I _{IN} = 0	—	—	100	μA			
	F						100				
Collector-Emitter Saturation Voltage		V _{CE (sat)}	2	I _{OUT} = 350 mA, I _{IN} = 600 μA	—	1.3	2.2	V			
				I _{OUT} = 200 mA, I _{IN} = 400 μA	—	1.1	2.0				
				I _{OUT} = 100 mA, I _{IN} = 200 μA	—	1.0	1.8				
DC Current Transfer Ratio		h _{FE}	2	V _{CE} = 2 V, I _{OUT} = 350 mA	1000	—	—				
Input Current	Output On	I _{IN (ON)}	3	V _{IN} = 1.5 V, I _{OUT} = 350 mA	—	0.25	—	mA			
									TD62101P / F		
									TD62103P / F		
									TD62104P / F		
									TD62105P / F		
	Output Off	I _{IN (OFF)}	4	I _{OUT} = 500 μA	V _{CE} = 2 V	—	—	—	μA		
										P	
										F	
										Ta = 75°C	
										Ta = 85°C	
Input Voltage	Output On	V _{IN (ON)}	5	V _{CE} = 2 V	—	—	—	V			
									TD62103P / F	I _{OUT} = 125 mA	2.1
									TD62104P / F	I _{OUT} = 125 mA	4
									TD62105P / F	I _{OUT} = 125 mA	6.4
									TD62103P / F	I _{OUT} = 250 mA	2.7
									TD62104P / F	I _{OUT} = 250 mA	7
									TD62105P / F	I _{OUT} = 250 mA	12
									TD62103P / F	I _{OUT} = 350 mA	3.3
									TD62104P / F	I _{OUT} = 350 mA	8.8
									TD62105P / F	I _{OUT} = 350 mA	15
Input Capacitance		C _{IN}	6	V _{IN} = 0, f = 1 MHz	—	15	—	pF			
Turn-On Delay		t _{ON}	7	V _{OUT} = 25 V, R _L = 70 Ω C _L = 15 pF	—	0.1	—	μs			
Turn-Off Delay		t _{OFF}			—	0.2	—				

TEST CIRCUIT

1. I_{CEX}

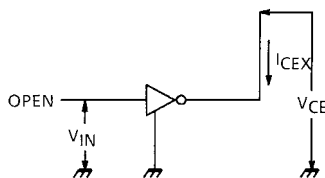

2. h_{FE}, V_{CE (sat)}

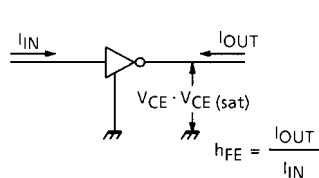

3. I_{IN (ON)}

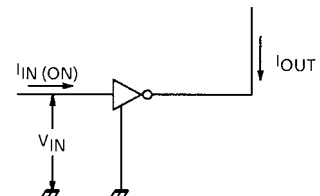

TEST CIRCUIT

4. I_{IN} (OFF)

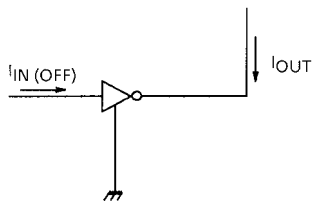

5. V_{IN} (ON)

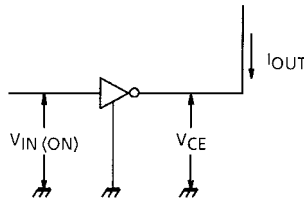

6. C_{IN}

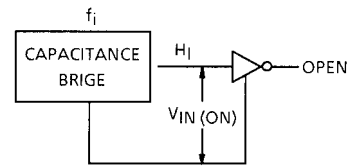

7. t_{ON}, t_{OFF}

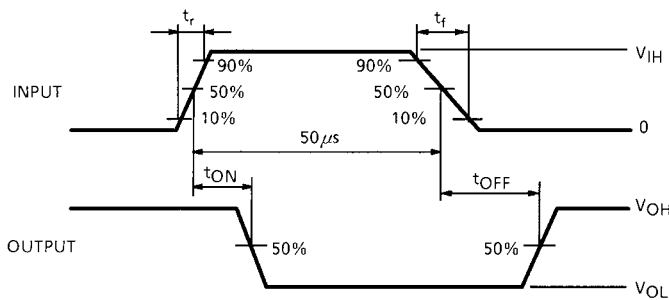
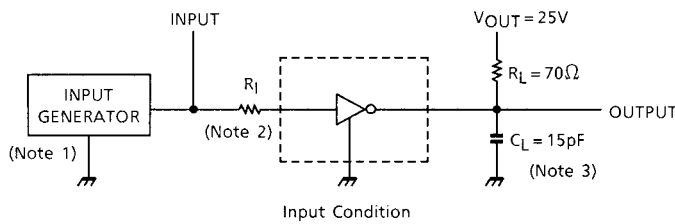

- Note 1: Pulse Width 50 μs, Duty Cycle 10%
Output Impedance 50 Ω, t_r ≤ 5 ns, t_f ≤ 10 ns
- Note 2: See right.
- Note 3: C_L includes probe and jig capacitance.

INPUT CONDITION

TYPE NUMBER	R _I	V _{IH}
TD62101P / F	2.7 kΩ	3 V
TD62103P / F	0 Ω	3 V
TD62104P / F	0 Ω	8 V
TD62105P / F	0 Ω	15 V

PRECAUTIONS for USING

This IC does not include built-in protection circuits for excess current or overvoltage. If this IC is subjected to excess current or overvoltage, it may be destroyed. Hence, the utmost care must be taken when systems which incorporate this IC are designed. Utmost care is necessary in the design of the output line, GND line since IC may be destroyed due to short-circuit between outputs, air contamination fault, or fault by improper grounding.

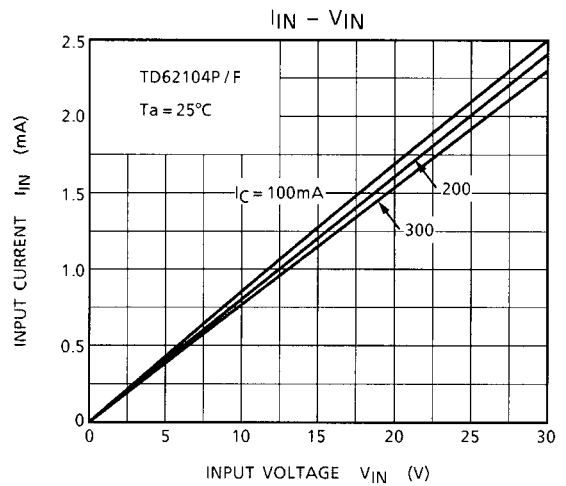
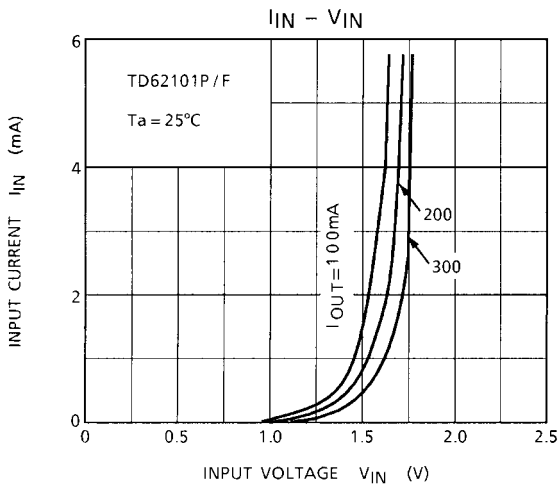
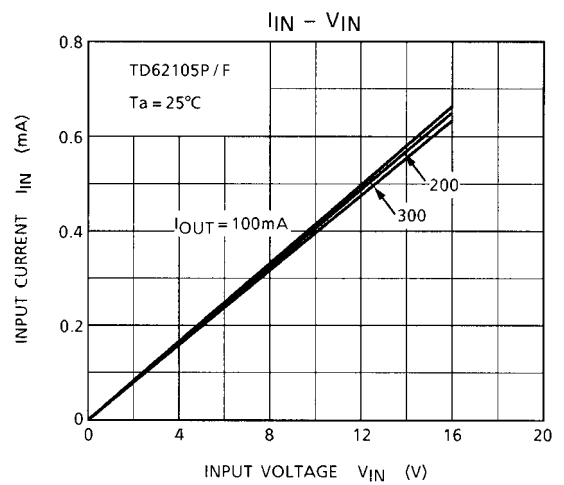
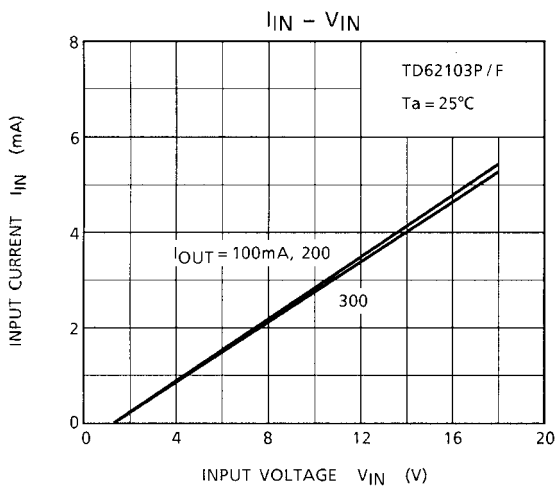
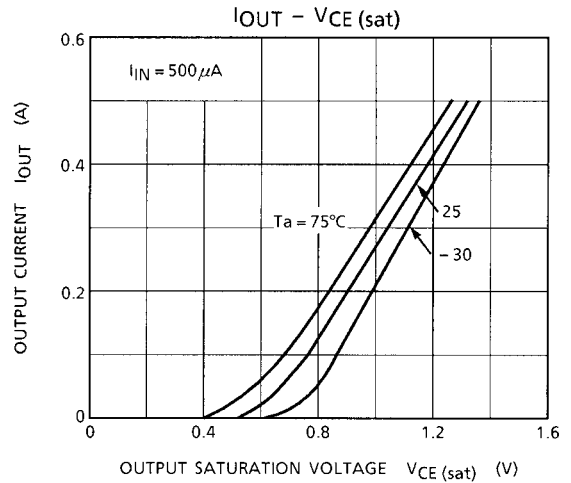
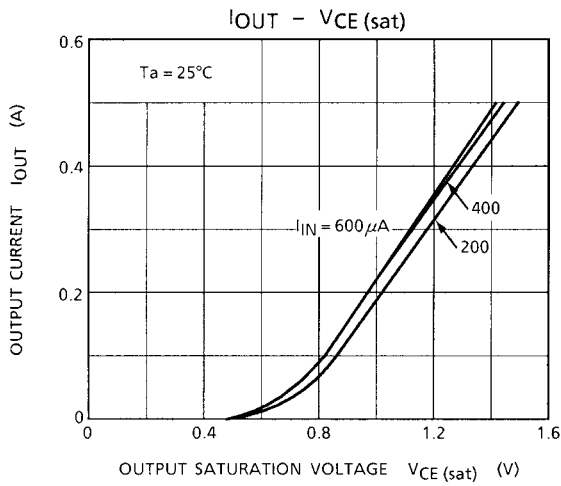

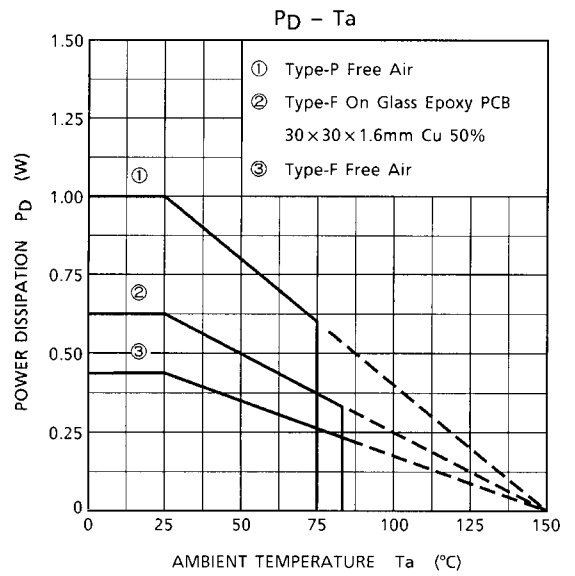
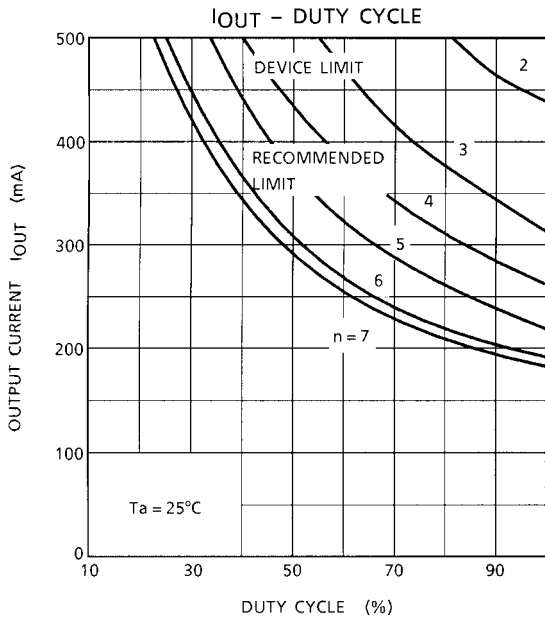
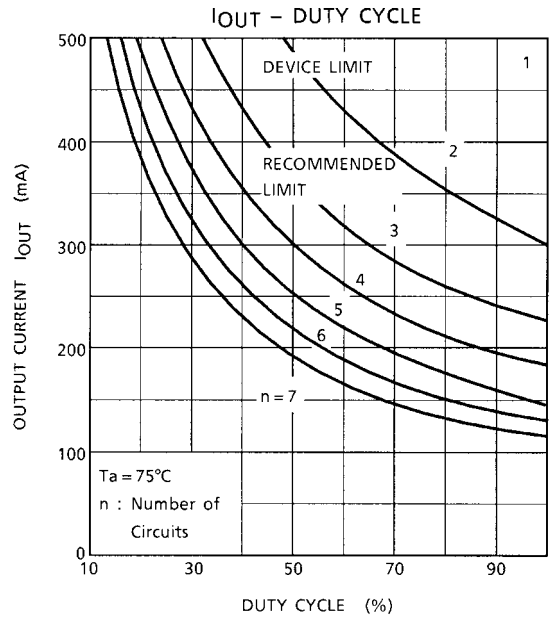
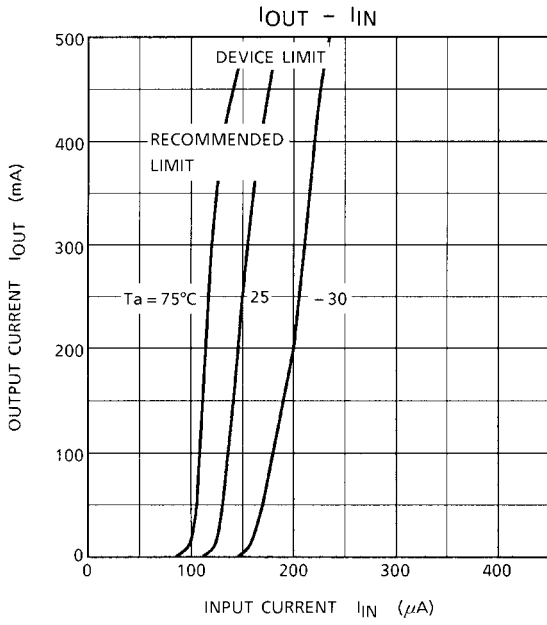

PACKAGE DIMENSIONS

DIP16-P-300-2.54A

Unit: mm

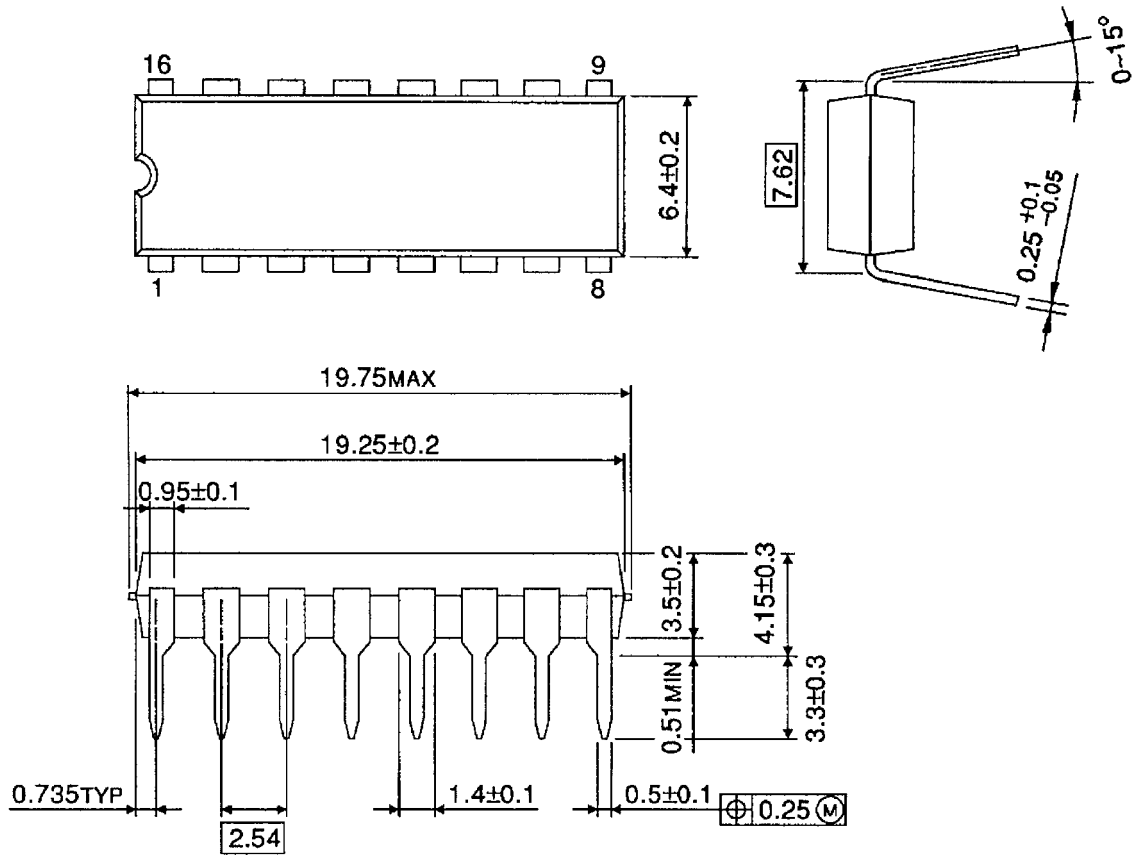

Weight: 1.11 g (typ.)

PACKAGE DIMENSIONS

SOP16-P-225-1.27

Unit: mm

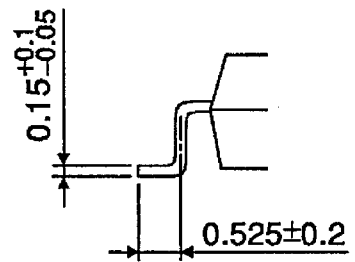
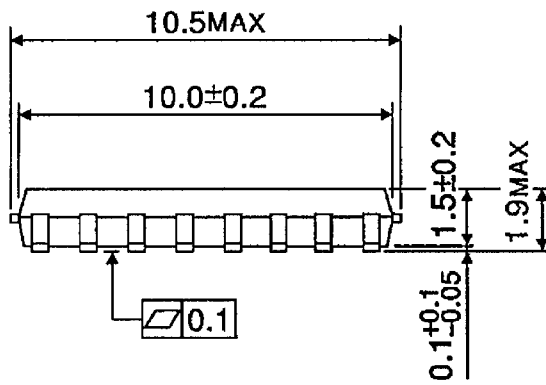
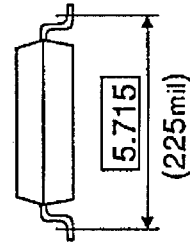
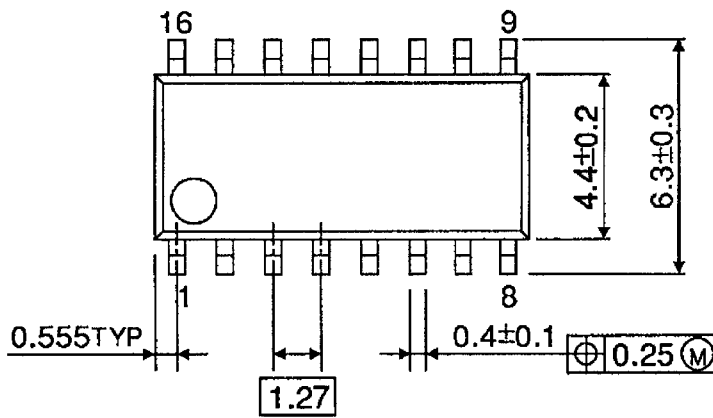

Weight: 0.16 g (typ.)

RESTRICTIONS ON PRODUCT USE

000707EBA

- TOSHIBA is continually working to improve the quality and reliability of its products. Nevertheless, semiconductor devices in general can malfunction or fail due to their inherent electrical sensitivity and vulnerability to physical stress. It is the responsibility of the buyer, when utilizing TOSHIBA products, to comply with the standards of safety in making a safe design for the entire system, and to avoid situations in which a malfunction or failure of such TOSHIBA products could cause loss of human life, bodily injury or damage to property.
In developing your designs, please ensure that TOSHIBA products are used within specified operating ranges as set forth in the most recent TOSHIBA products specifications. Also, please keep in mind the precautions and conditions set forth in the "Handling Guide for Semiconductor Devices," or "TOSHIBA Semiconductor Reliability Handbook" etc..
- The TOSHIBA products listed in this document are intended for usage in general electronics applications (computer, personal equipment, office equipment, measuring equipment, industrial robotics, domestic appliances, etc.). These TOSHIBA products are neither intended nor warranted for usage in equipment that requires extraordinarily high quality and/or reliability or a malfunction or failure of which may cause loss of human life or bodily injury ("Unintended Usage"). Unintended Usage include atomic energy control instruments, airplane or spaceship instruments, transportation instruments, traffic signal instruments, combustion control instruments, medical instruments, all types of safety devices, etc.. Unintended Usage of TOSHIBA products listed in this document shall be made at the customer's own risk.
- The products described in this document are subject to the foreign exchange and foreign trade laws.
- The information contained herein is presented only as a guide for the applications of our products. No responsibility is assumed by TOSHIBA CORPORATION for any infringements of intellectual property or other rights of the third parties which may result from its use. No license is granted by implication or otherwise under any intellectual property or other rights of TOSHIBA CORPORATION or others.
- The information contained herein is subject to change without notice.