

TOSHIBA BIPOLAR DIGITAL INTEGRATED CIRCUIT SILICON MONOLITHIC

# TD62304FB, TD62305FB

## 7CH LOW INPUT ACTIVE DARLINGTON SINK DRIVER

The TD62304FB and TD62305FB are non-inverting transistor arrays, which are comprised of seven NPN darlington buffer-transistor output stages PNP input stages. These devices can be operated by source input voltage and are suitable for operations with a 5-V general purposed logic IC such as 5-V TTL, 5-V CMOS and 5-V Microprocessor which have sink current output drivers. Please observe the thermal condition for using.

### FEATURES

- Output current (single output) : 500 mA (Max.)
- High sustaining voltage : 35 V (Min.)
- Low level active input
- Inputs compatible with 5-V TTL and 5-V CMOS
- Package type-FB: SOP-16 pin

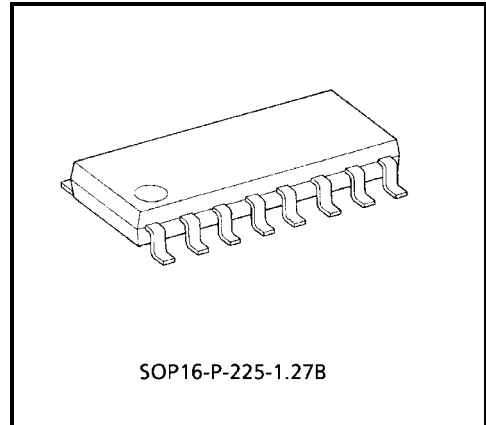

Weight: 0.16 g (Typ.)

### PIN CONNECTION (TOP VIEW)

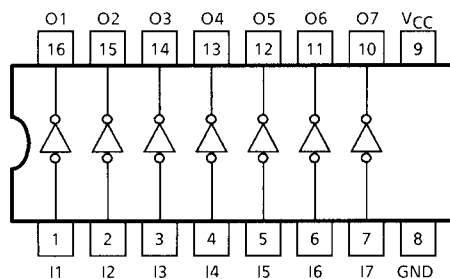

### SCHEMATICS (EACH DRIVER)

#### TD62304FB

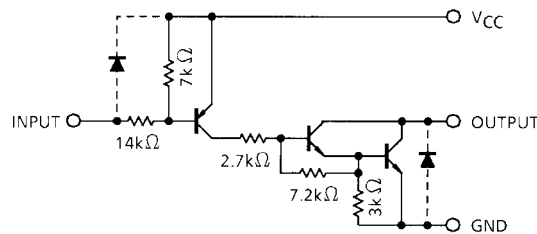

#### TD62305FB

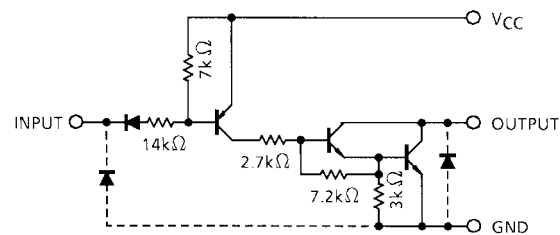

Note: The input and output parasitic diodes cannot be used as clamp diodes.

## MAXIMUM RATINGS (Ta = 25°C)

CHARACTERISTIC	SYMBOL	RATING	UNIT
Supply Voltage	V <sub>CC</sub>	-0.5~7.0	V
Output Sustaining Voltage	V <sub>CE (SUS)</sub>	-0.5~35	V
Output Current	I <sub>OUT</sub>	500	mA / ch
Input Voltage	V <sub>IN</sub>	-22~V <sub>CC</sub> + 0.5	V
		-0.5~7 (Note 1)	
Input Current	I <sub>IN</sub>	-10	mA
Power Dissipation	P <sub>D</sub>	0.625 (Note 2)	W
Operating Temperature	T <sub>opr</sub>	-40~85	°C
Storage Temperature	T <sub>stg</sub>	-55~150	°C

Note 1: On glass epoxy PCB (30 × 30 × 1.6 mm Cu 50%)

Note 2: TD62305FB only

## RECOMMENDED OPERATING CONDITIONS (Ta = -40~85°C)

CHARACTERISTIC		SYMBOL	CONDITION	MIN	TYP.	MAX	UNIT	
Supply Voltage		V <sub>CC</sub>	—	4.5	—	5.5	V	
Output Sustaining Voltage		V <sub>CE (SUS)</sub>	—	0	—	35	V	
Output Current		I <sub>OUT</sub>	DC 1 Circuit	0	—	400	mA / ch	
			T <sub>pw</sub> ≤ 25 ms 7 circuits	Duty = 10%	0	—		240
			T <sub>j</sub> = 120°C Ta = 85°C (Note)	Duty = 50%	0	—		60
Input Voltage	TD62304FB	V <sub>IN</sub>	—	-20	—	V <sub>CC</sub>	V	
	TD62305FB			0	—	5.5		
Input Voltage (Outout On)	TD62304FB	V <sub>IN(ON)</sub>	—	-22	—	V <sub>CC</sub> - 3.5	V	
	TD62305FB			-0.5	—	V <sub>CC</sub> - 3.7		
Input Voltage (Outout Off)	TD62304FB	V <sub>IN(OFF)</sub>	—	V <sub>CC</sub> - 0.4	—	V <sub>CC</sub>	V	
	TD62305FB			V <sub>CC</sub> - 0.6	—	V <sub>CC</sub>		
Power Dissipation		P <sub>D</sub>	(Note)	—	—	0.325	W	

Note: On glass epoxy PCB (30 × 30 × 1.6 mm Cu 50%)

## ELECTRICAL CHARACTERISTICS (Ta = 25°C)

CHARACTERISTIC		SYMBOL	TEST CIR-CUIT	TEST CONDITION	MIN	TYP.	MAX	UNIT	
Output Leakage Current		$I_{CEX}$	1	$V_{CC} = 5.5\text{ V}$ , $V_{OUT} = 35\text{ V}$ $T_a = 85^\circ\text{C}$ , $I_{IN} = 0$	—	—	-100	$\mu\text{A}$	
Output Saturation Voltage		$V_{CE (sat)}$	2	$V_{CC} = 4.5\text{ V}$ , $I_{OUT} = 350\text{ mA}$	$V_{IN} = V_{IN (ON)}$ (Max.)	—	1.4	2.0	V
					$V_{IN} = 0.8\text{ V}$	—	1.4	2.2	
Input Current	(Output On)	$I_{IN (ON)}$	3	$V_{CC} = 5.5\text{ V}$ , $V_{IN} = 0.4\text{ V}$	—	-0.32	-0.45	mA	
	(Output Off)	$I_{IN (OFF)}$	4	—	—	—	-2.6		
Input Voltage (Output On)	TD62304FB	$V_{IN(ON)}$	5	—	—	—	$V_{CC}$ -2.8	V	
	TD62305FB				—	—	$V_{CC}$ -3.7		
Supply Current	(Output On)	$I_{CC (ON)}$	6	$V_{CC} = 5.5\text{ V}$ , $V_{IN} = 0\text{ V}$	—	17	22	mA	
	(Output Off)	$I_{CC (OFF)}$		$V_{CC} = V_{IN} = 5.5\text{ V}$	—	—	100		$\mu\text{A}$
Turn-On Delay	$t_{ON}$		7	$V_{CC} = 5\text{ V}$ , $C_L = 15\text{ pF}$ $V_{OUT} = 35\text{ V}$ , $R_L = 87.5\ \Omega$	—	0.1	—	$\mu\text{s}$	
Turn-Off Delay	$t_{OFF}$				—	3	—		

**TEST CIRCUIT**

**1.  $I_{CEX}$**

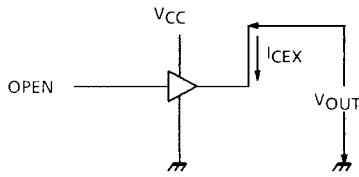

**2.  $V_{CE(sat)}$**

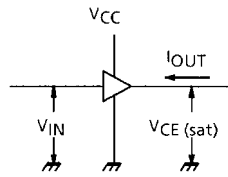

**3.  $I_{IN(ON)}$**

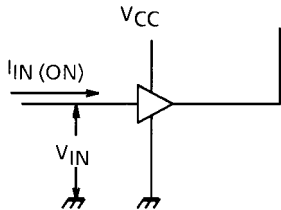

**4.  $I_{IN(OFF)}$**

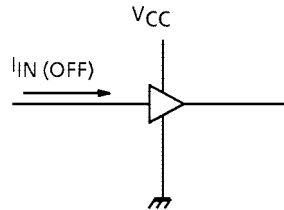

**5.  $V_{IN(ON)}$**

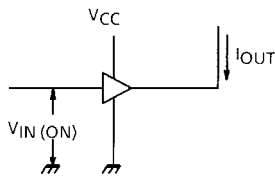

**6.  $I_{CC}$**

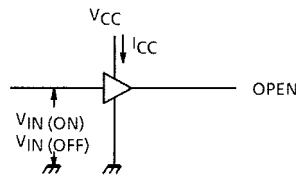

**7.  $t_{ON}$ ,  $t_{OFF}$**

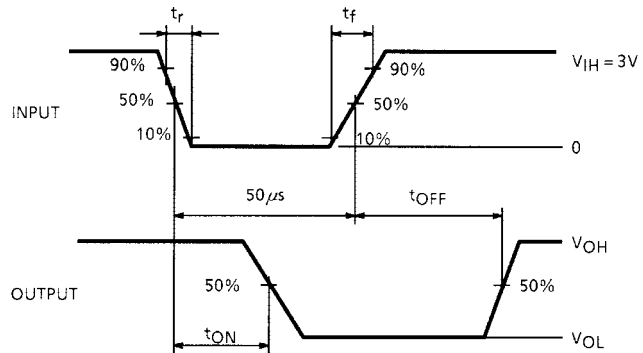
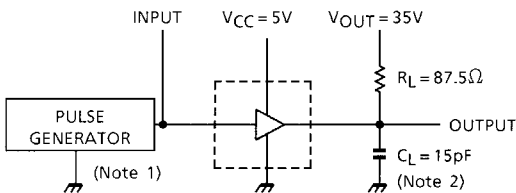

Note 1: Pulse width 50  $\mu$ s, duty cycle 10%  
 Output impedance 50  $\Omega$ ,  $t_r \leq 10$  ns,  $t_f \leq 5$  ns  
 Note 2:  $C_L$  includes probe and jig capacitance

**PRECAUTIONS for USING**

This IC does not include built-in protection circuits for excess current or overvoltage. If this IC is subjected to excess current or overvoltage, it may be destroyed. Hence, the utmost care must be taken when systems which incorporate this IC are designed. Utmost care is necessary in the design of the output line, VCC and GND line since IC may be destroyed due to short-circuit between outputs, air contamination fault, or fault by improper grounding.

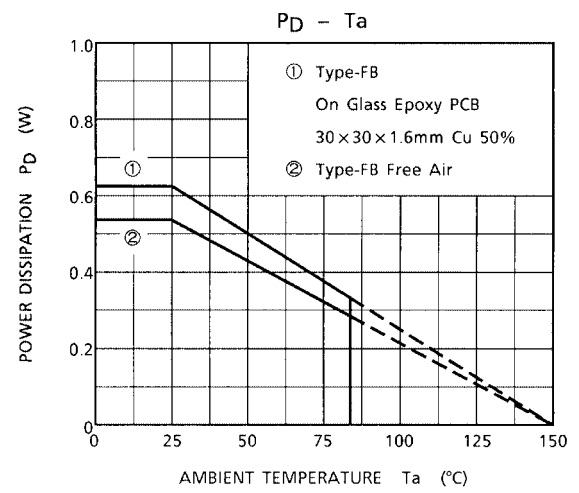
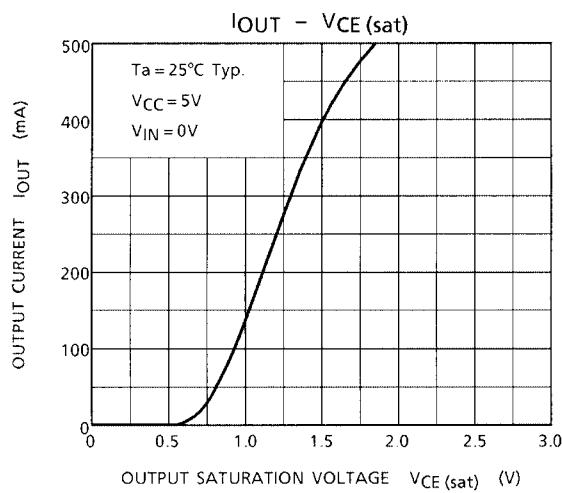
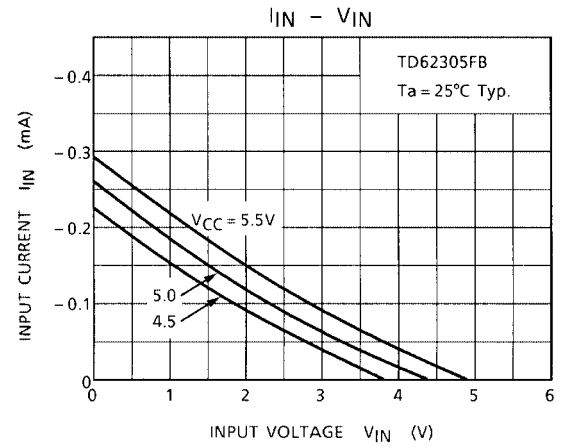
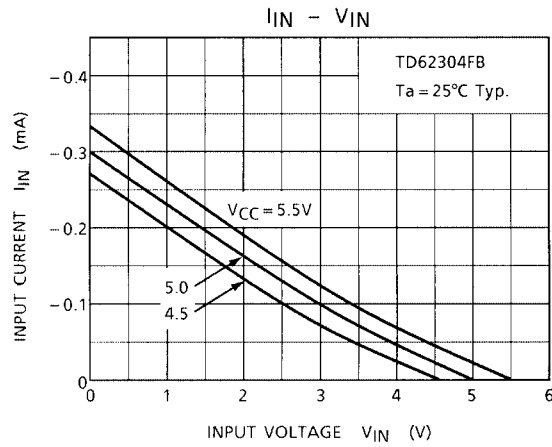
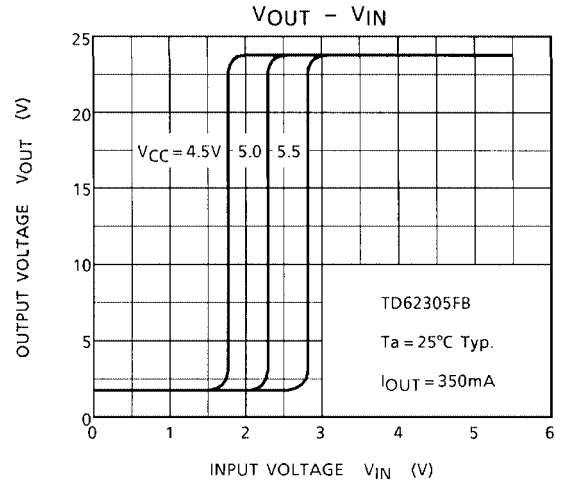
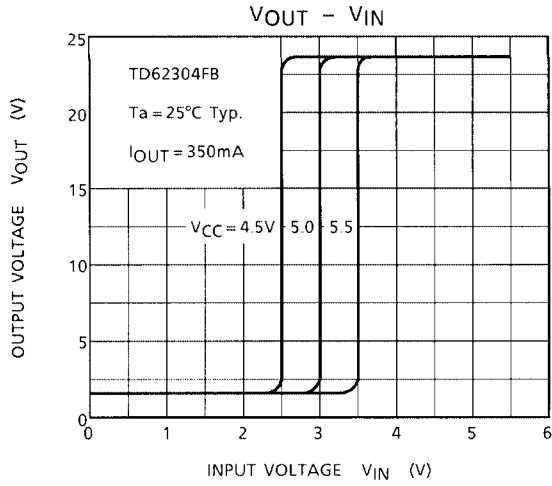

**PACKAGE DIMENSIONS**

SOP16-P-225-1.27B

Unit : mm

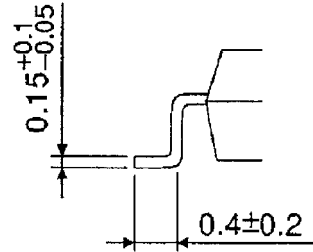
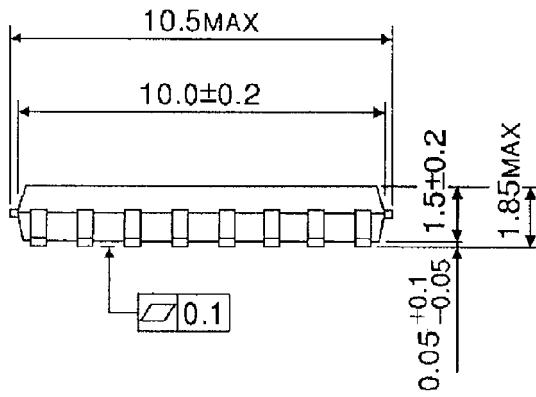
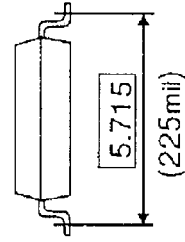
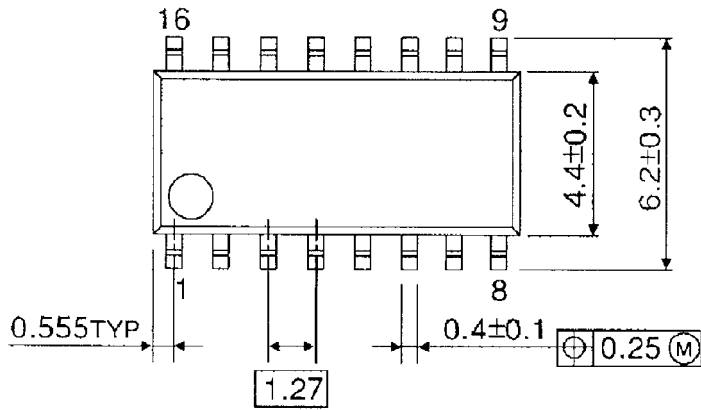

Weight: 0.16 g (Typ.)

**RESTRICTIONS ON PRODUCT USE**

000707EBA

- TOSHIBA is continually working to improve the quality and reliability of its products. Nevertheless, semiconductor devices in general can malfunction or fail due to their inherent electrical sensitivity and vulnerability to physical stress. It is the responsibility of the buyer, when utilizing TOSHIBA products, to comply with the standards of safety in making a safe design for the entire system, and to avoid situations in which a malfunction or failure of such TOSHIBA products could cause loss of human life, bodily injury or damage to property.  
In developing your designs, please ensure that TOSHIBA products are used within specified operating ranges as set forth in the most recent TOSHIBA products specifications. Also, please keep in mind the precautions and conditions set forth in the "Handling Guide for Semiconductor Devices," or "TOSHIBA Semiconductor Reliability Handbook" etc..
- The TOSHIBA products listed in this document are intended for usage in general electronics applications (computer, personal equipment, office equipment, measuring equipment, industrial robotics, domestic appliances, etc.). These TOSHIBA products are neither intended nor warranted for usage in equipment that requires extraordinarily high quality and/or reliability or a malfunction or failure of which may cause loss of human life or bodily injury ("Unintended Usage"). Unintended Usage include atomic energy control instruments, airplane or spaceship instruments, transportation instruments, traffic signal instruments, combustion control instruments, medical instruments, all types of safety devices, etc.. Unintended Usage of TOSHIBA products listed in this document shall be made at the customer's own risk.
- The products described in this document are subject to the foreign exchange and foreign trade laws.
- The information contained herein is presented only as a guide for the applications of our products. No responsibility is assumed by TOSHIBA CORPORATION for any infringements of intellectual property or other rights of the third parties which may result from its use. No license is granted by implication or otherwise under any intellectual property or other rights of TOSHIBA CORPORATION or others.
- The information contained herein is subject to change without notice.