

TOSHIBA BIPOLAR DIGITAL INTEGRATED CIRCUIT SILICON MONOLITHIC

TD62307P, TD62307F

7CH LOW SATURATION SINK DRIVER

The TD62307P, TD62307F are comprised of seven NPN low saturation drivers.

All units feature integral clamp diodes for switching inductive loads and protective diodes against a negative input voltage. Applications include relay, hammer, lamp and LED driver.

FEATURES

- Low saturation output $V_{CE(sat)} = 0.6\text{ V (Max.)}$
@ $I_{OUT} = 120\text{ mA}$
- Output rating (single output) 20 V (Min.) / 150 mA (Max.)
- Inputs compatible with 5~15 V PMOS, CMOS
- Input protective diodes against a negative input voltage
- Package type-P : DIP-16 pin
- Package type-F : SOP-16 pin

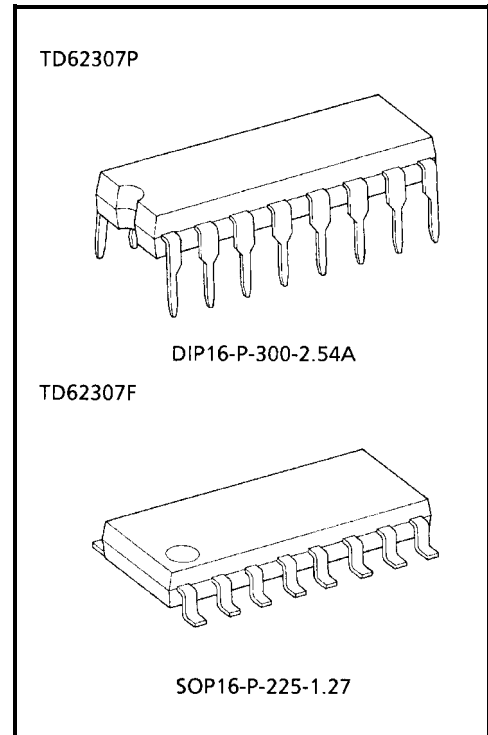

Weight
 DIP16-P-300-2.54A : 1.11 g (Typ.)
 SOP16-P-225-1.27 : 0.16 g (Typ.)

PIN CONNECTION (TOP VIEW)

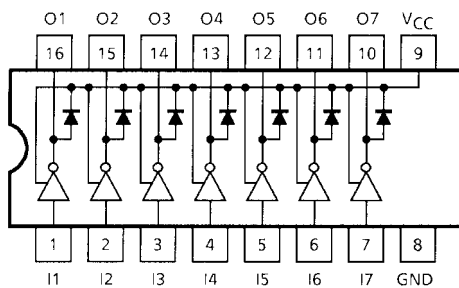

SCHEMATICS (EACH DRIVER)

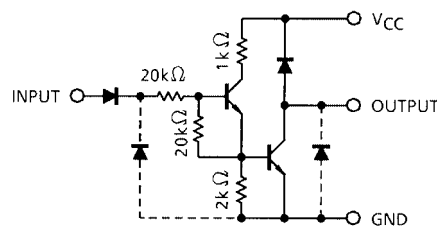

Note: The input and output parasitic diodes cannot be used as clamp diodes.

MAXIMUM RATINGS (Ta = 25°C)

CHARACTERISTIC	SYMBOL	RATING	UNIT	
Supply Voltage	V _{CC}	-0.5~20	V	
Output Sustaining Voltage	V _{CE(SUS)}	-0.5~V _{CC} +0.5	V	
Output Current	I _{OUT}	150	mA / ch	
Input Voltage	V _{IN}	-37~20	V	
Input Current	I _{IN}	1.5	mA	
Clamp Diode Reverse Voltage	V _R	20	V	
Clamp Diode Forward Current	I _F	120	mA	
Power Dissipation	P	P _D	1.0	W
	F		0.625 (Note)	
Operating Temperature	P	T _{opr}	-30~75	°C
	F		-40~85	
Storage Temperature	T _{stg}	-55~150	°C	

Note: On Glass Epoxy PCB (30 × 30 × 1.6 mm Cu 50%)

RECOMMENDED OPERATING CONDITIONS (Ta = -40~85°C for Type-F and Ta = -30~75°C for Type-P)

CHARACTERISTIC	SYMBOL	CONDITION	MIN	TYP.	MAX	UNIT
Supply Voltage	V _{CC}	—	4.75	—	18	V
Output Current	I _{OUT}	DC 1 Circuit	0	—	120	mA / ch
		T _{pw} = 25 ms, Duty = 10% 7 Circuits	0	—	100	
Input Voltage	V _{IN}	—	-35	—	V _{CC}	V
Clamp Diode Reverse Voltage	V _R	—	—	—	18	V
Clamp Diode Forward Current	I _F	—	—	—	120	mA
Power Dissipation	P	P _D	—	—	0.44	W
	F		(Note)	—	—	

Note: On Glass Epoxy PCB (30 × 30 × 1.6 mm Cu 50%)

ELECTRICAL CHARACTERISTICS (Ta = 25°C)

CHARACTERISTIC		SYMBOL	TEST CIR-CUIT	TEST CONDITION	MIN	TYP.	MAX	UNIT
Output Leakage Current	P	I _{CEX}	1	V _{CC} = 18 V V _{OUT} = 18 V	—	—	100	μA
	F						Ta = 75°C	
Output Saturation Voltage		V _{CE (sat)}	2	V _{CC} = 5 V, I _{IN} = 0.2 mA I _{OUT} = 120 mA	—	0.45	0.6	V
DC Forward Current Transfer Ratio		h _{FE}	2	V _{CC} = 5 V, V _{OUT} = 2 V I _{OUT} = 120 mA	1000	—	—	—
Input Current	Output On	I _{IN (ON)}	3	V _{IN} = 5 V, I _{OUT} = 120 mA	—	0.16	0.23	mA
	Output Off	I _{IN (OFF)}		4	V _{IN} = 15 V, I _{OUT} = 120 mA	—	0.66	
Clamp Diode Forward Voltage		V _F	5	I _F = 120 mA	—	1.25	1.6	V
Supply Current	Output On	I _{CC (ON)}	6	V _{CC} = V _{IN} = 5 V	—	4.0	6.0	mA / Gate
	Output Off	I _{CC (OFF)}		6	V _{CC} = V _{IN} = 15 V	—	14.0	
Turn-On Delay		t _{ON}	7	V _{CC} = 18 V, R _L = 150 Ω C _L = 15 pF	—	0.1	—	μs
Turn-Off Delay		t _{OFF}			—	0.8	—	

TEST CIRCUIT

1. I_{CEX}

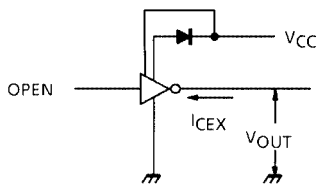

2. h_{FE}, V_{CE (sat)}

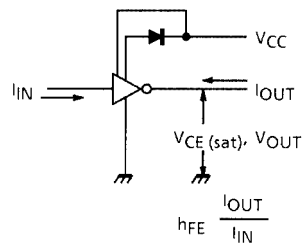

3. I_{IN (ON)}

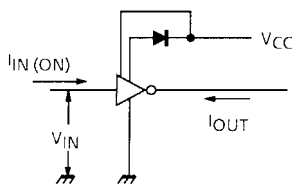

4. I_{IN (OFF)}

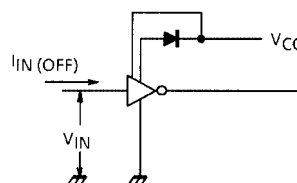

5. V_F

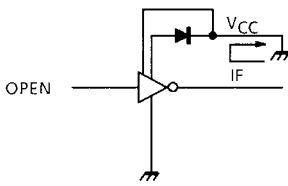

6. I_{CC}

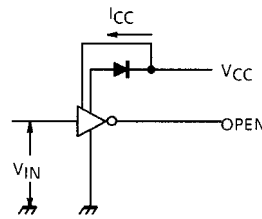

7. t_{ON} , t_{OFF}

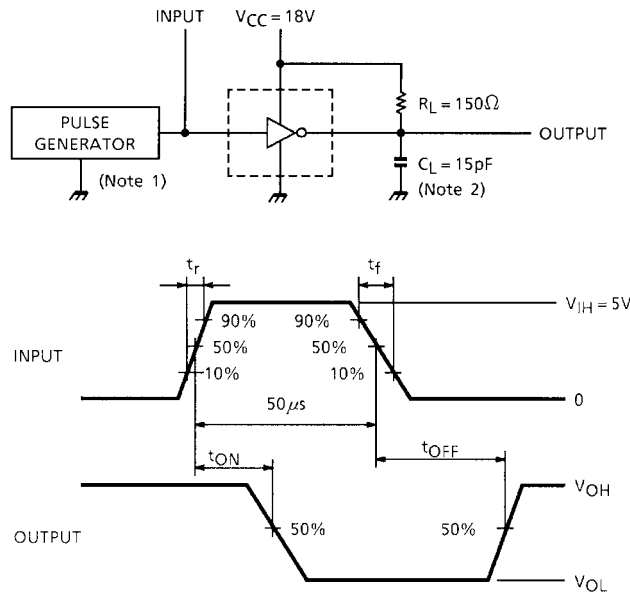

Note 1: Pulse Width 50 μ s, Duty Cycle 10%
 Output Impedance 50 Ω , $t_r \leq 5$ ns, $t_f \leq 10$ ns
 Note 2: C_L includes probe and jig capacitance

PRECAUTIONS for USING

This IC does not include built-in protection circuits for excess current or overvoltage. If this IC is subjected to excess current or overvoltage, it may be destroyed. Hence, the utmost care must be taken when systems which incorporate this IC are designed. Utmost care is necessary in the design of the output line, VCC and GND line since IC may be destroyed due to short-circuit between outputs, air contamination fault, or fault by improper grounding.

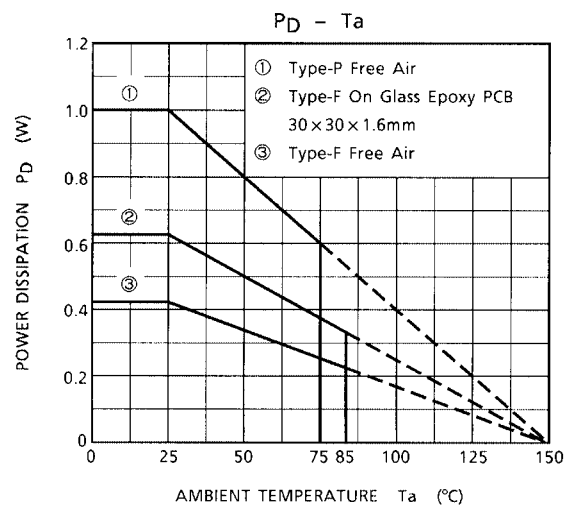
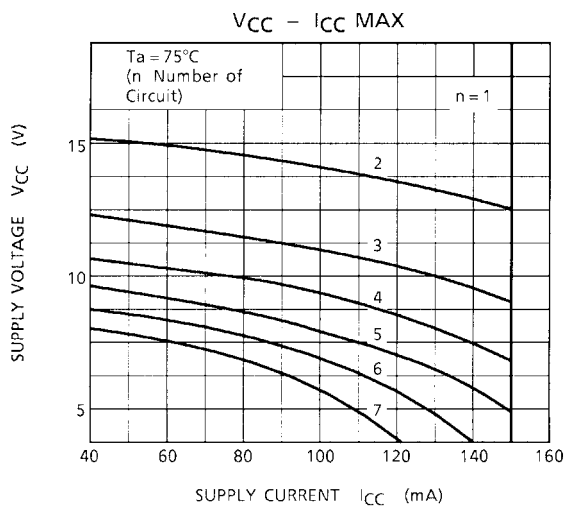
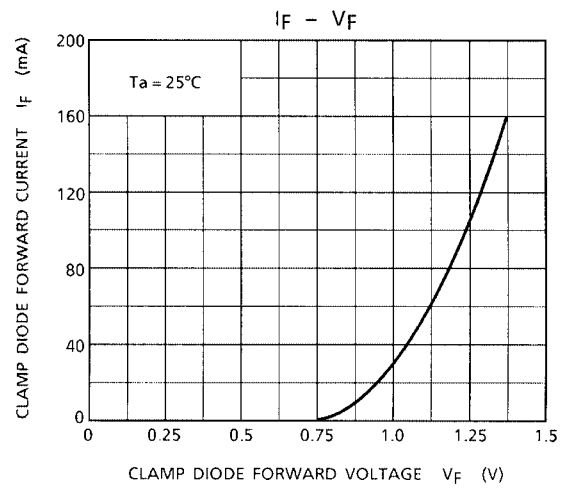
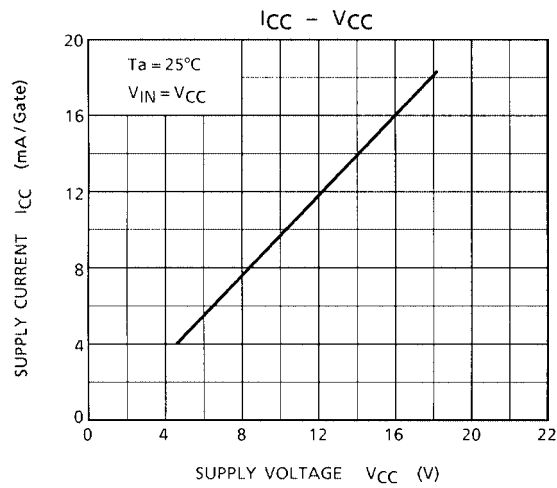
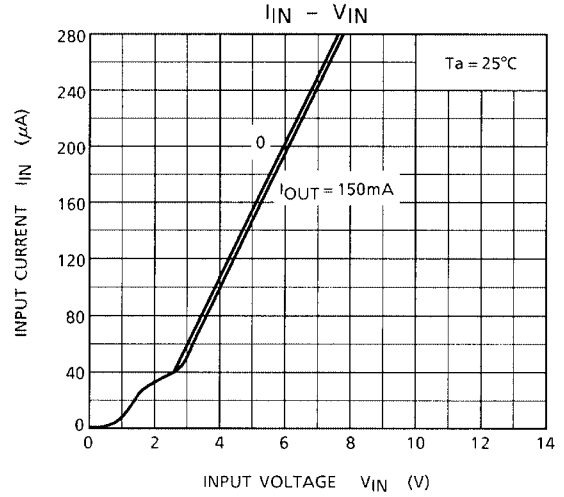
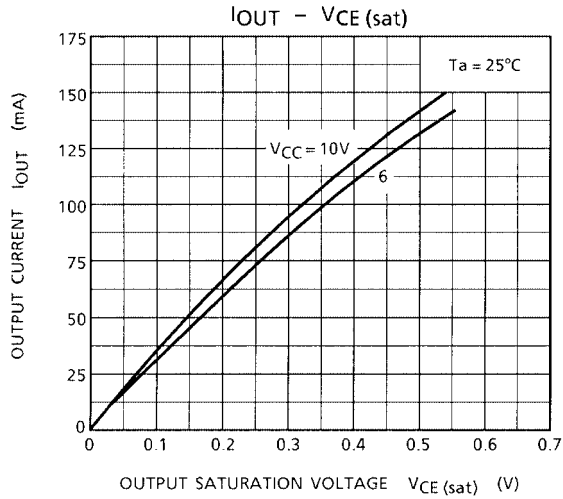

PACKAGE DIMENSIONS

DIP16-P-300-2.54A

Unit: mm

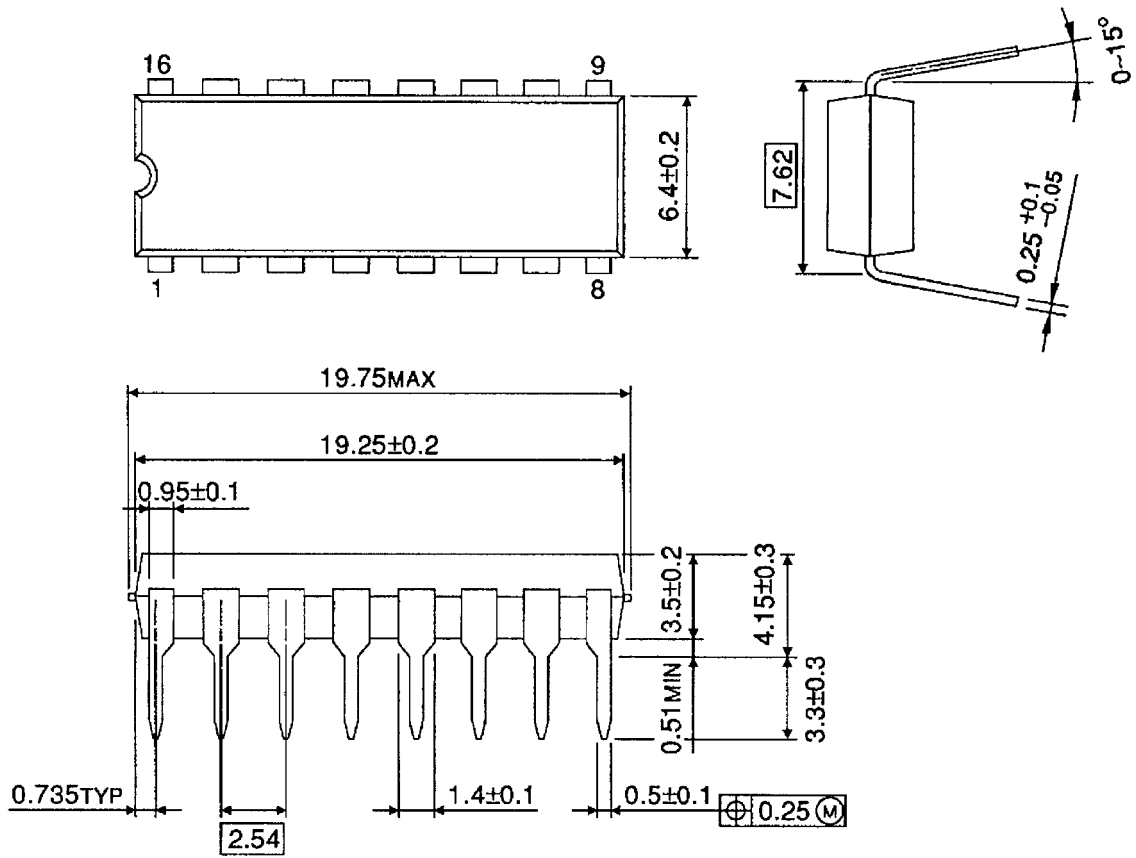

Weight: 1.11 g (Typ.)

PACKAGE DIMENSIONS

SOP16-P-225-1.27

Unit: mm

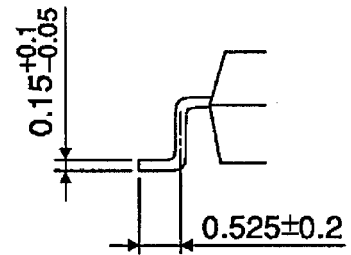
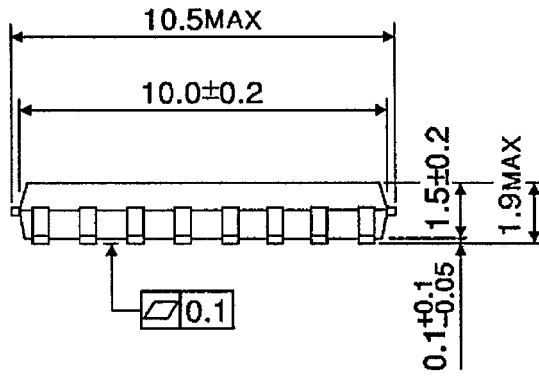
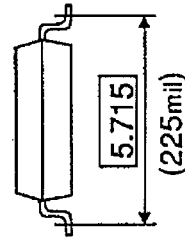
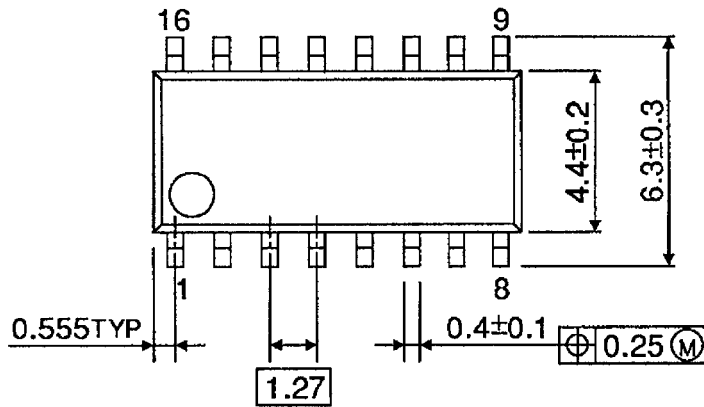

Weight: 0.16 g (Typ.)

RESTRICTIONS ON PRODUCT USE

000707EBA

- TOSHIBA is continually working to improve the quality and reliability of its products. Nevertheless, semiconductor devices in general can malfunction or fail due to their inherent electrical sensitivity and vulnerability to physical stress. It is the responsibility of the buyer, when utilizing TOSHIBA products, to comply with the standards of safety in making a safe design for the entire system, and to avoid situations in which a malfunction or failure of such TOSHIBA products could cause loss of human life, bodily injury or damage to property.
In developing your designs, please ensure that TOSHIBA products are used within specified operating ranges as set forth in the most recent TOSHIBA products specifications. Also, please keep in mind the precautions and conditions set forth in the "Handling Guide for Semiconductor Devices," or "TOSHIBA Semiconductor Reliability Handbook" etc..
- The TOSHIBA products listed in this document are intended for usage in general electronics applications (computer, personal equipment, office equipment, measuring equipment, industrial robotics, domestic appliances, etc.). These TOSHIBA products are neither intended nor warranted for usage in equipment that requires extraordinarily high quality and/or reliability or a malfunction or failure of which may cause loss of human life or bodily injury ("Unintended Usage"). Unintended Usage include atomic energy control instruments, airplane or spaceship instruments, transportation instruments, traffic signal instruments, combustion control instruments, medical instruments, all types of safety devices, etc.. Unintended Usage of TOSHIBA products listed in this document shall be made at the customer's own risk.
- The products described in this document are subject to the foreign exchange and foreign trade laws.
- The information contained herein is presented only as a guide for the applications of our products. No responsibility is assumed by TOSHIBA CORPORATION for any infringements of intellectual property or other rights of the third parties which may result from its use. No license is granted by implication or otherwise under any intellectual property or other rights of TOSHIBA CORPORATION or others.
- The information contained herein is subject to change without notice.