

TD62504P-H

7CH SINGLE DRIVER : COMMON EMITTER

The TD62504P-H is comprised of seven or five NPN Transistor Arrays.
Applications include relay, hammer, lamp and display (LED) drivers.

FEATURES

- Package Type : DIP16 pin
- $R_{IN} = 10.5\text{ k}\Omega$
- High Sustaining Voltage Output : $V_{CEO} = 35\text{ V (Min)}$
- Output Current (Single Output) : 200 mA (Max)
- Low Saturation Voltage : $V_{CE(sat)} = 0.8\text{ V}$
@ $I_{out} = 150\text{ mA}$
- Inputs Compatible with Various Types of Logic.
- Wide operating temperature range: $-40\sim 105^{\circ}\text{C}$

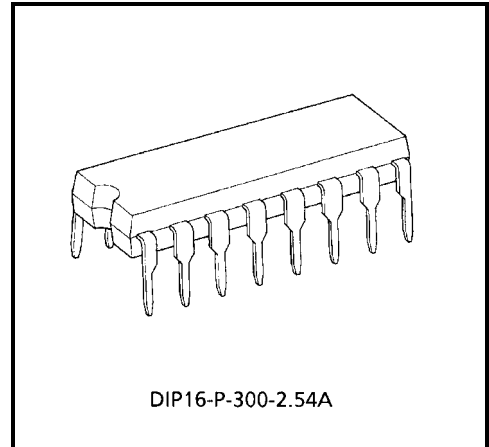

Weight: 0.11 g (Typ.)

PIN CONNECTION (TOP VIEW)

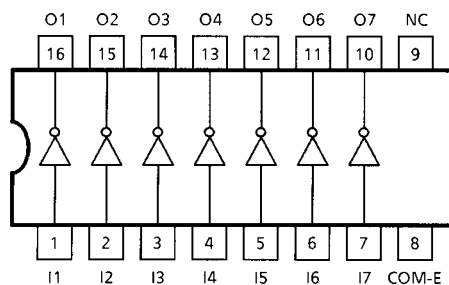

SCHEMATICS (EACH DRIVER)

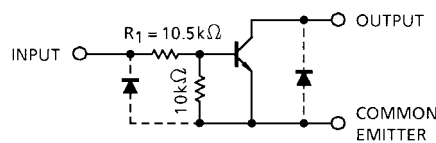

Note: The input and output parasitic diodes cannot be used as clamp diodes.

MAXIMUM RATINGS (Ta = 25°C)

CHARACTERISTIC	SYMBOL	RATING	UNIT
Collector-Emitter Voltage	V _{CEO}	35	V
Collector-Base Voltage	V _{CB0}	50	V
Collector Current	I _C	200	mA / ch
Input Voltage	V _{IN}	-0.5~30	V
Power Dissipation	P _D	1.0	W
Operating Temperature	T _{opr}	-40~105	°C
Storage Temperature	T _{stg}	-55~150	°C

RECOMMENDED OPERATING CONDITIONS (Ta = -40~85°C)

CHARACTERISTIC	SYMBOL	CONDITION	MIN	TYP.	MAX	UNIT
Collector-Emitter Voltage	V _{CEO}	—	0	—	35	V
Collector-Base Voltage	V _{CB0}	—	0	—	50	V
Collector Current	I _C	—	0	—	150	mA / ch
Input Voltage	V _{IN}	—	0	—	25	V
	V _{IN (ON)}	I _{IN} = 1 mA	15.0	—	25	
Power Dissipation	P _D	Ta = 85°C	—	—	0.52	W

ELECTRICAL CHARACTERISTICS (Ta = 25°C)

CHARACTERISTIC	SYMBOL	TEST CIR-CUIT	TEST CONDITION	MIN	TYP.	MAX	UNIT
Output Leakage Current	I _{CEX}	1	V _{CE} = 35 V, V _{IN} = 0 V	—	—	10	μA
Collector-Emitter Saturation Voltage	V _{CE (sat)}	2	I _{IN} = 1 mA, I _C = 10 mA	—	—	0.2	V
			I _{IN} = 3 mA, I _C = 150 mA	—	—	0.8	
DC Current Transfer Ratio	h _{FE}	2	V _{CE} = 10 V, I _C = 10 mA	50	—	—	—
Input Voltage	V _{IN (ON)}	3	I _{IN} = 1 mA, I _C = 10 mA	7.5	11.5	15.0	V
Turn-On Delay	t _{ON}	4	V _{CEO} = 35 V, R _L = 220 Ω C _L = 15 pF	—	50	—	ns
Turn-Off Delay	t _{OFF}			—	200	—	

RECOMMENDED OPERATING CONDITIONS (Ta = -40~105°C)

CHARACTERISTIC	SYMBOL	CONDITION	MIN	TYP.	MAX	UNIT
Collector-Emitter Voltage	V _{CEO}	—	0	—	35	V
Collector-Base Voltage	V _{CB0}	—	0	—	50	V
Collector Current	I _C	DC 1 circuits	0	—	150	mA / ch
		7 circuits	0	—	100	
Input Voltage	V _{IN}	—	0	—	25	V
	V _{IN (ON)}	I _{IN} = 1 mA	15.0	—	25	
	V _{IN (OFF)}	—	0	—	0.50	
Power Dissipation	P _D	Ta = 105°C	—	—	0.36	W

ELECTRICAL CHARACTERISTICS (Ta = 105°C)

CHARACTERISTIC	SYMBOL	TEST CIR-CUIT	TEST CONDITION	MIN	TYP.	MAX	UNIT
Output Leakage Current	I_{CEX}	1	$V_{CE} = 35\text{ V}, V_{IN} = 0\text{ V}$	—	—	300	μA
Collector-Emitter Saturation Voltage	$V_{CE(sat)}$	2	$I_{IN} = 1\text{ mA}, I_C = 10\text{ mA}$	—	—	0.3	V
			$I_{IN} = 3\text{ mA}, I_C = 150\text{ mA}$	—	—	0.9	
DC Current Transfer Ratio	h_{FE}	2	$V_{CE} = 10\text{ V}, I_C = 10\text{ mA}$	50	—	—	—
Input Voltage	$V_{IN(ON)}$	3	$I_{IN} = 1\text{ mA}, I_C = 10\text{ mA}$	6.5	11.5	16.0	V
Turn-On Delay	t_{ON}	4	$V_{CEO} = 35\text{ V}, R_L = 220\ \Omega$ $C_L = 15\text{ pF}$	—	100	—	ns
Turn-Off Delay	t_{OFF}			—	500	—	

TEST CIRCUIT

1. I_{CEX}

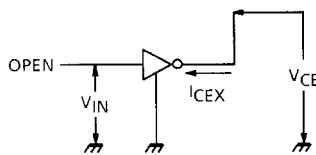

2. $h_{FE}, V_{CE(sat)}$

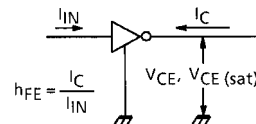

3. $V_{IN(ON)}$

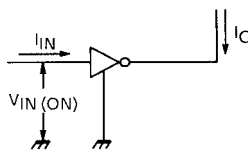

4. t_{ON}, t_{OFF}

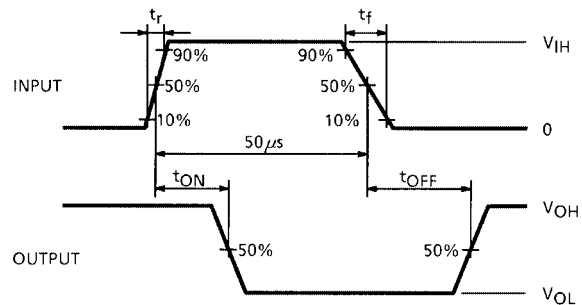
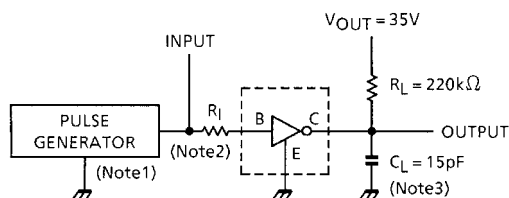

Note 1: Pulse Width 50 μs , Duty Cycle 10%
Output Impedance 50 Ω , $t_r \leq 5\text{ ns}$, $t_f \leq 10\text{ ns}$

Note 2: See below

Input Condition

TYPE NUMBER	R_I	V_{IH}
TD62504P-H	0 Ω	10 V

Note 3: C_L includes probe and jig capacitance

PRECAUTIONS for USING

This IC does not integrate protection circuits such as overcurrent and overvoltage protectors.

Thus, if excess current or voltage is applied to the IC, the IC may be damaged. Please design the IC so that excess current or voltage will not be applied to the IC.

Utmost care is necessary in the design of the output line, V_{CC} and GND line since IC may be destroyed due to short-circuit between outputs, air contamination fault, or fault by improper grounding.

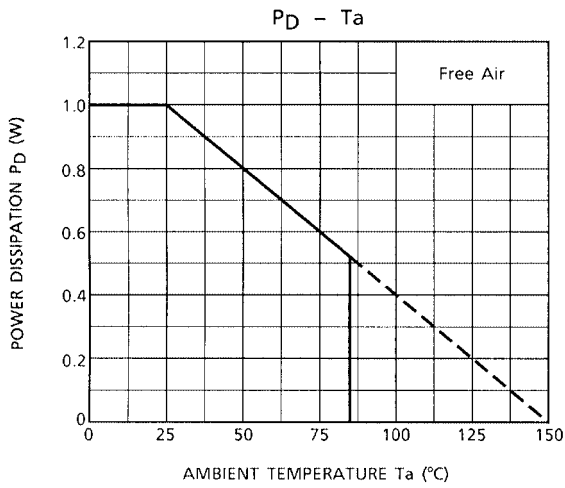
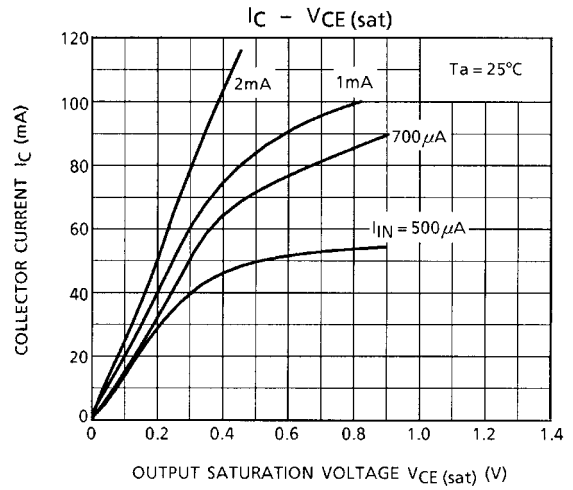
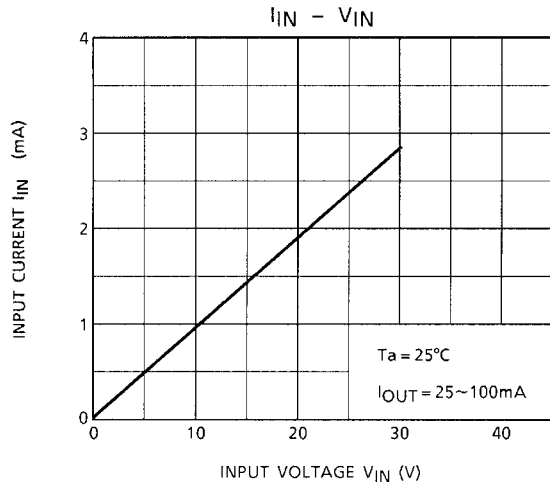

PACKAGE DIMENSIONS

DIP16-P-300-2.54A

Unit: mm

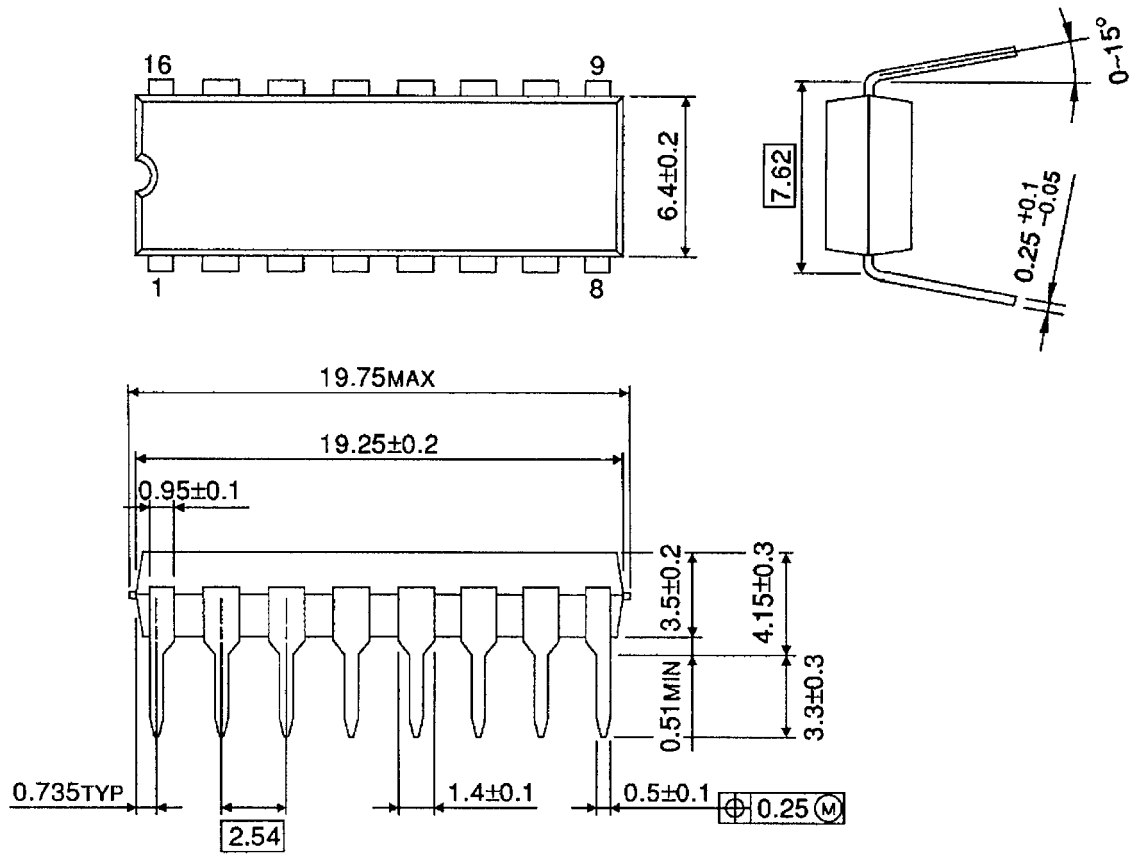

Weight: 1.11 g (Typ.)

RESTRICTIONS ON PRODUCT USE

000707EBA

- TOSHIBA is continually working to improve the quality and reliability of its products. Nevertheless, semiconductor devices in general can malfunction or fail due to their inherent electrical sensitivity and vulnerability to physical stress. It is the responsibility of the buyer, when utilizing TOSHIBA products, to comply with the standards of safety in making a safe design for the entire system, and to avoid situations in which a malfunction or failure of such TOSHIBA products could cause loss of human life, bodily injury or damage to property.
In developing your designs, please ensure that TOSHIBA products are used within specified operating ranges as set forth in the most recent TOSHIBA products specifications. Also, please keep in mind the precautions and conditions set forth in the "Handling Guide for Semiconductor Devices," or "TOSHIBA Semiconductor Reliability Handbook" etc..
- The TOSHIBA products listed in this document are intended for usage in general electronics applications (computer, personal equipment, office equipment, measuring equipment, industrial robotics, domestic appliances, etc.). These TOSHIBA products are neither intended nor warranted for usage in equipment that requires extraordinarily high quality and/or reliability or a malfunction or failure of which may cause loss of human life or bodily injury ("Unintended Usage"). Unintended Usage include atomic energy control instruments, airplane or spaceship instruments, transportation instruments, traffic signal instruments, combustion control instruments, medical instruments, all types of safety devices, etc.. Unintended Usage of TOSHIBA products listed in this document shall be made at the customer's own risk.
- The products described in this document are subject to the foreign exchange and foreign trade laws.
- The information contained herein is presented only as a guide for the applications of our products. No responsibility is assumed by TOSHIBA CORPORATION for any infringements of intellectual property or other rights of the third parties which may result from its use. No license is granted by implication or otherwise under any intellectual property or other rights of TOSHIBA CORPORATION or others.
- The information contained herein is subject to change without notice.