

TOSHIBA BIPOLAR DIGITAL INTEGRATED CIRCUIT SILICON MONOLITHIC
TD62501P,TD62501F,TD62502P,TD62502F,TD62503P,TD62503F,TD62504P
TD62504F,TD62505P,TD62505F,TD62506P,TD62506F,TD62507P,TD62507F

7CH SINGLE DRIVER

TD62501, 502, 503, 504P / F : COMMON EMITTER

TD62505, 506P / F : COMMON COLLECTOR

TD62507P / F : ISOLATED

The TD62501P / F Series are comprised of seven or five NPN Transistor Arrays.

For proper operation, the substrate (SUB) must be connected to the most negative voltage.

Applications include relay, hammer, Lamp and display (LED) drivers.

FEATURES

- Output Current (Single Output) 200 mA MAX.
- High Sustaining Voltage Output 35 V MIN.
- Inputs Compatible with Various Types of Logic.
- TD62501P / F, TD62505P / F and TD62507P / F: Using external resistor...General Purpose
- TD62502P / F
: R_{IN} = 10.5 kΩ + 7V Zener Diode...14~25 V P-MOS
- TD62503P / F, TD62506P / F
: R_{IN} = 2.7 kΩ...TTL, 5 V C-MOS
- TD62504P / F, : R_{IN} = 10.5 kΩ...6~15 V P-MOS, C-MOS
- Package Type-P : DIP-16 pin
- Package Type-F : SOP-16 pin

TD62501P, TD62502P
 TD62503P, TD62504P
 TD62505P, TD62506P
 TD62507P

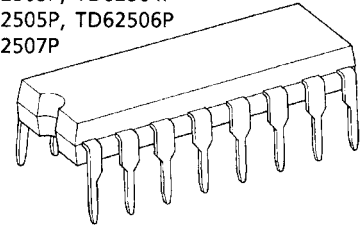

DIP16-P-300-2.54A

TD62501F, TD62502F
 TD62503F, TD62504F
 TD62505F, TD62506F
 TD62507F

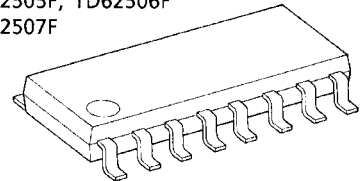

SOP16-P-225-1.27

Weight

DIP16-P-300-2.54A : 1.11 g (Typ.)

SOP16-P-225-1.27 : 0.16 g (Typ.)

PIN CONNECTION (Top view)

TD62501P / F, TD62502P / F
TD62503P / F, TD62504P / F

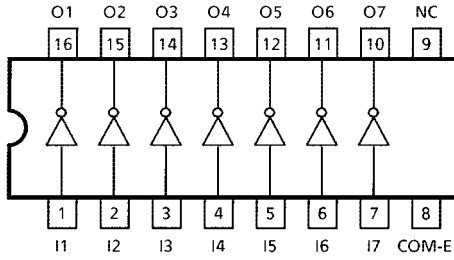

TD62505P / F, TD62506P / F

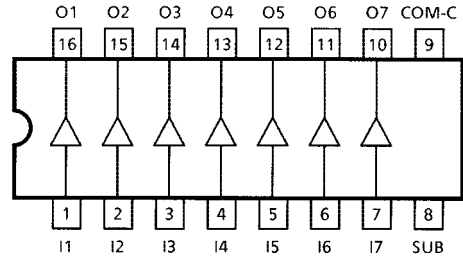

TD62507P / F

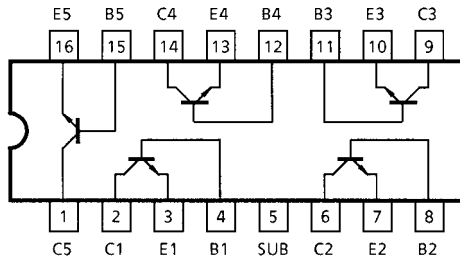

SCHEMATICS (Each driver)

TD62501P / F

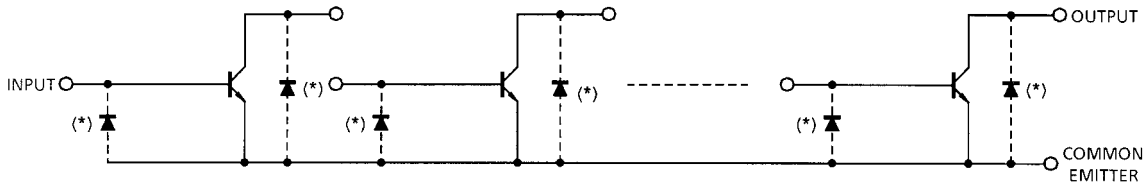

TD62502P / F

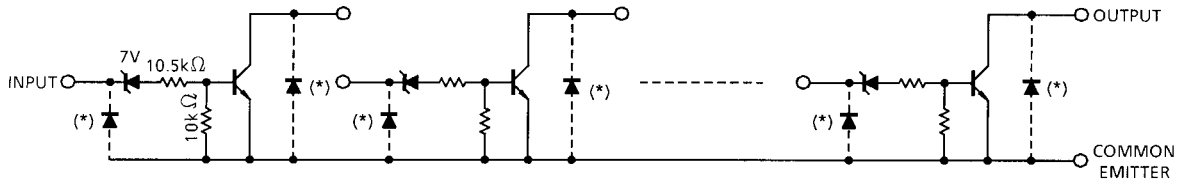

TD62503P / F

TD62504P / F

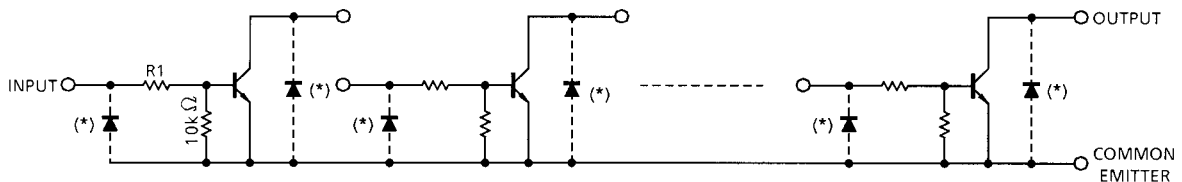

TD62503P / F R1 = 2.7 kΩ, TD62504P / F R1 = 10.5 kΩ

*: Parasitic Diodes

SCHEMATICS (Each driver)

TD62505P / F

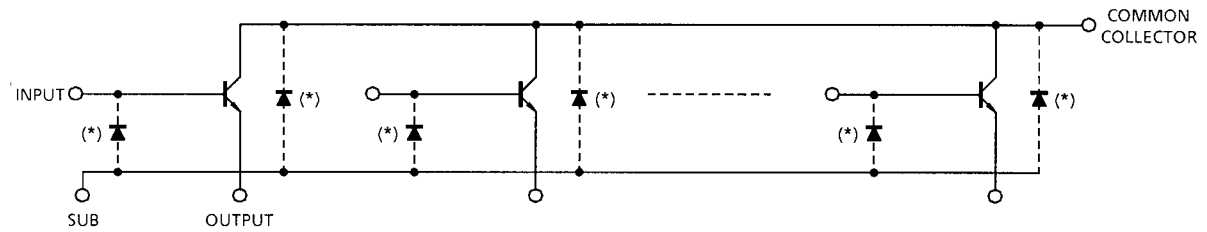

TD62506P / F

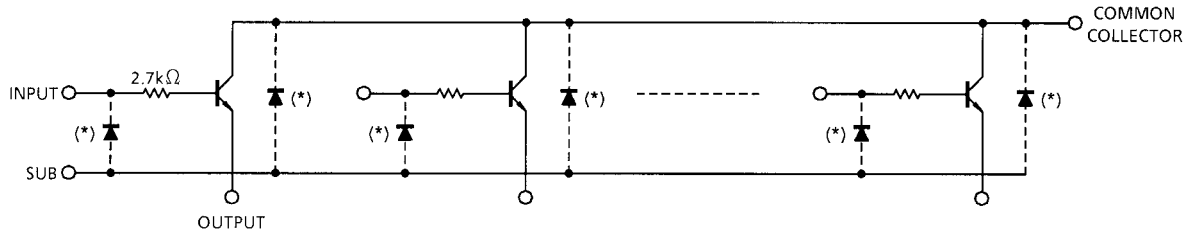

TD62507P / F

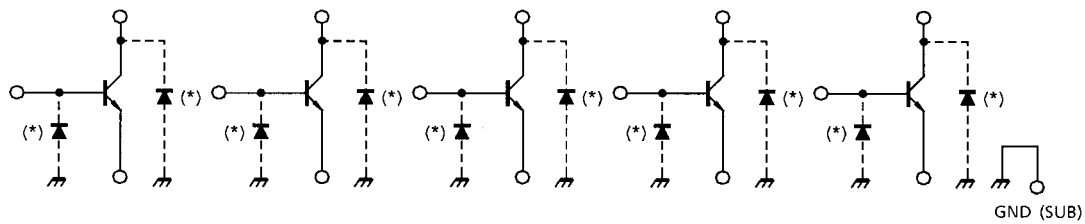

*: Parasitic Diodes

Note: The input and output parasitic diodes cannot be used as clamp diodes.

MAXIMUM RATINGS (Ta = 25°C Unless otherwise noted)

CHARACTERISTIC	SYMBOL	RATING	UNIT
Collector-Emitter Voltage	V_{CEO}	35	V
Collector-Base Voltage	V_{CBO}	50	V
Collector Current	I_C	200	mA / ch
Input Voltage	V_{IN} (Note 1)	-0.5~45	V
	V_{IN} (Note 2)	-0.5~30	
Input Current	I_{IN} (Note 3)	25	mA
Isolation Voltage	V_{SUB}	35	V
Power Dissipation	P	1.0	W
	F	0.625 (Note 4)	
Operating Temperature	T_{opr}	-40~85	°C
Storage Temperature	T_{stg}	-55~150	°C

Note 1: TD62506P / F

Note 2: TD62502P / F, TD62503P / F, TD62504P / F

Note 3: TD62501P / F, TD62505P / F, TD62507P / F

Note 4: On Glass Epoxy PCB (30 × 30 × 1.6 mm, Cu 50%)

RECOMMENDED OPERATING CONDITIONS (Ta = -40~85°C)

CHARACTERISTIC		SYMBOL	CONDITION	MIN	TYP.	MAX	UNIT
Collector-Emitter Voltage		V_{CEO}		0	—	35	V
Collector-Base Voltage		V_{CBO}		0	—	50	V
Collector Current		I_C		0	—	150	mA / ch
Input Voltage	TD62506P / F	V_{IN}		0	—	35	V
	TD62502P / F						
	TD62503P / F						
	TD62504P / F						
Input Current	TD62501P / F	I_{IN}		0	—	10	mA
	TD62505P / F						
	TD62507P / F						
Power Dissipation	P	P_D	On PCB (Note)	—	—	0.360	W
	F					0.325	

Note: 30 × 30 × 1.6 mm, Cu 50%

ELECTRICAL CHARACTERISTICS (Ta = 25°C Unless otherwise noted)

CHARACTERISTIC		SYMBOL	TEST CIR-CUIT	TEST CONDITION	MIN	TYP.	MAX	UNIT
Output Leakage Current		I_{CEX}	1	$V_{CE} = 25\text{ V}, V_{IN} = 0$	—	—	10	μA
Collector-Emitter Saturation Voltage		$V_{CE(sat)}$	2	$I_{IN} = 1\text{ mA}, I_C = 10\text{ mA}$	—	—	0.2	V
				$I_{IN} = 3\text{ mA}, I_C = 150\text{ mA}$ (Note 1)	—	—	0.8	
DC Current Transfer Ratio	(Note 2)	h_{FE}	2	$V_{CE} = 10\text{ V}, I_C = 10\text{ mA}$	70	—	—	
	(Note 3)				50	—	—	
Input Voltage	TD62502P / F	$V_{IN(ON)}$	3	$I_{IN} = 1\text{ mA}$ $I_C = 10\text{ mA}$	13	17	23	V
	TD62503P / F				2.4	3.4	4.2	
	TD62504P / F				7.5	11.5	15	
Turn-On Delay	t_{ON}	4		$V_{OUT} = 35\text{ V}, R_L = 3.3\text{ k}\Omega$ $C_L = 15\text{ pF}$	—	50	—	ns
Turn-Off Delay	t_{OFF}				—	200	—	

Note 1: Except TD62502P / F Only

Note 2: Only TD62501P / F, TD62505P / F, TD62506P / F, TD62507P / F

Note 3: Only TD62502P / F, TD62503P / F, TD62504P / F

TEST CIRCUIT

1. I_{CEX}

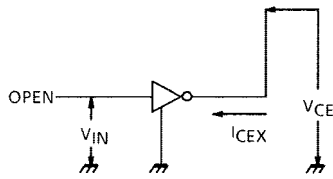

2. h_{FE} , $V_{CE(sat)}$

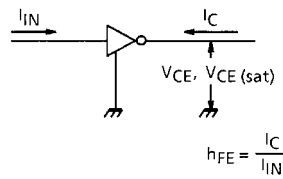

3. $V_{IN(ON)}$

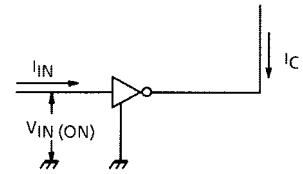

4. t_{ON} , t_{OFF}

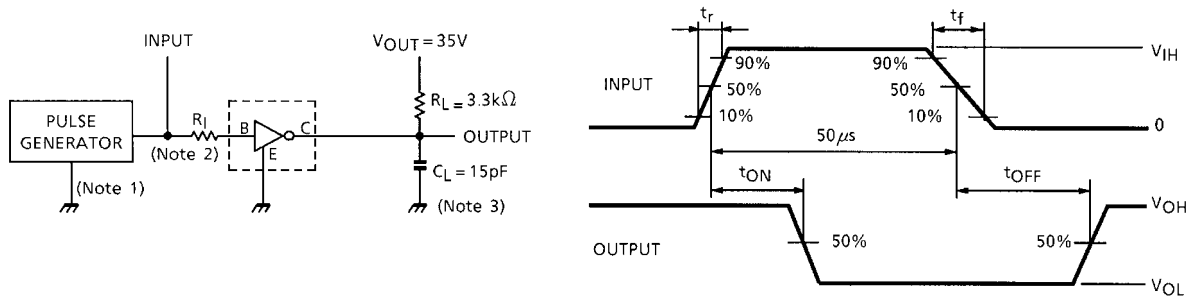

Note 1: Pulse Width 50 μ s, Duty Cycle 10%
 Output Impedance 50 Ω , $t_r \leq 5$ ns, $t_f \leq 10$ ns
 Note 2: See below

INPUT CONDITION

TYPE NUMBER	R_I	V_{IH}
TD62501P / F	2.7 k Ω	3 V
TD62502P / F	0 Ω	15 V
TD62503P / F	0 Ω	3 V
TD62504P / F	0 Ω	10 V
TD62505P / F	2.7 k Ω	3 V
TD62506P / F	0 Ω	3 V
TD62507P / F	2.7 k Ω	3 V

Note 3: C_L includes probe and jig capacitance

PRECAUTIONS for USING

This IC does not integrate protection circuits such as overcurrent and overvoltage protectors. Thus, if excess current or voltage is applied to the IC, the IC may be damaged. Please design the IC so that excess current or voltage will not be applied to the IC. Utmost care is necessary in the design of the output line, VCC and GND line since IC may be destroyed due to short-circuit between outputs, air contamination fault, or fault by improper grounding.

STATIC CHARACTERISTICS

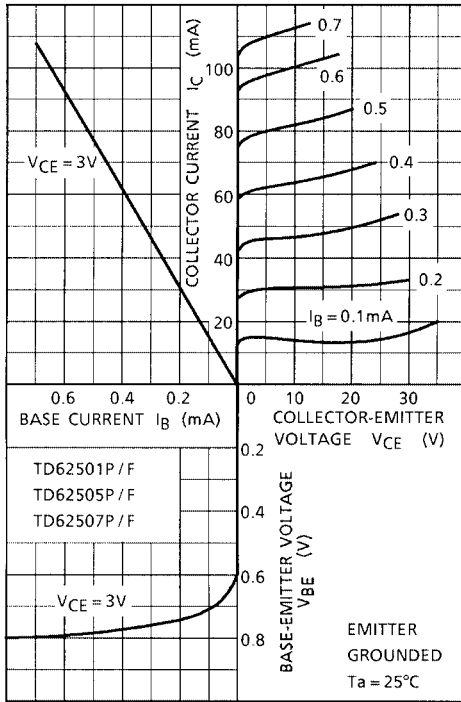

$P_D - T_a$

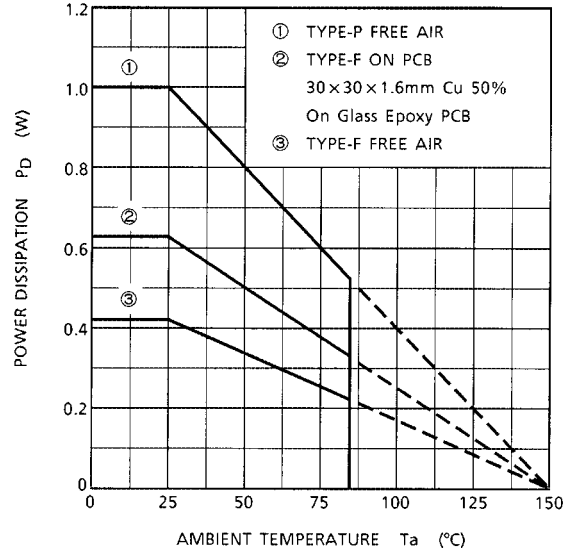

$V_{CE}(\text{sat}), h_{FE} - I_C$

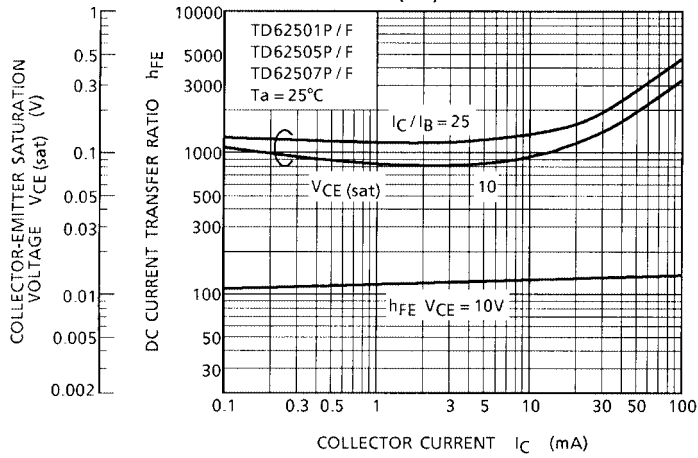

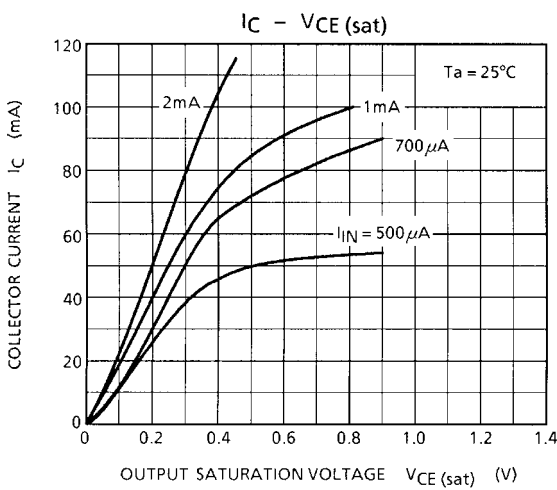
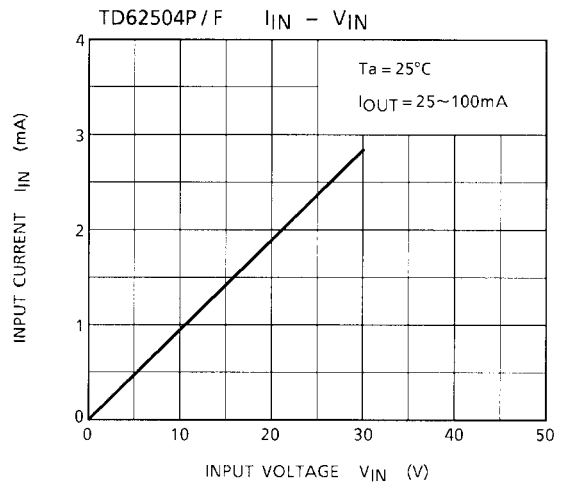
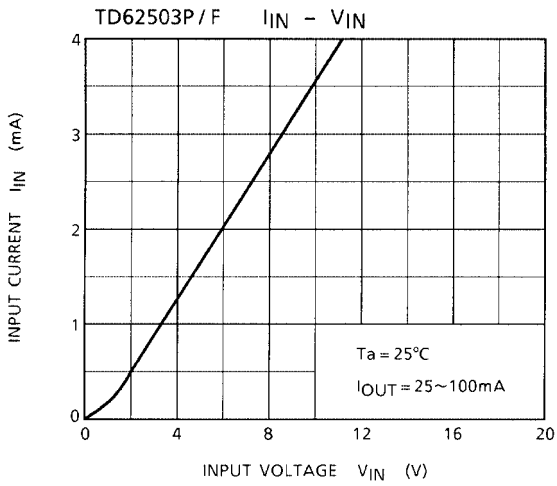
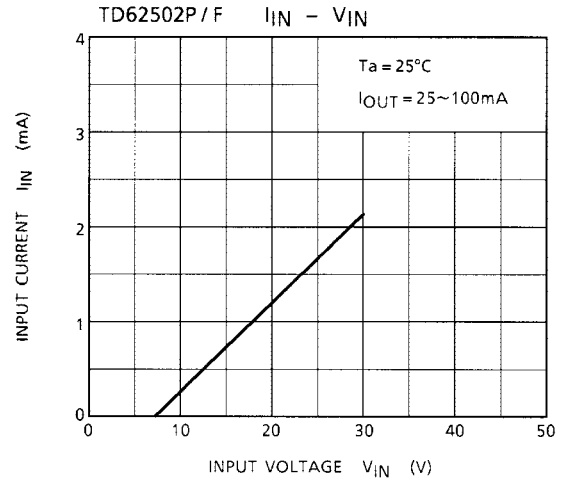
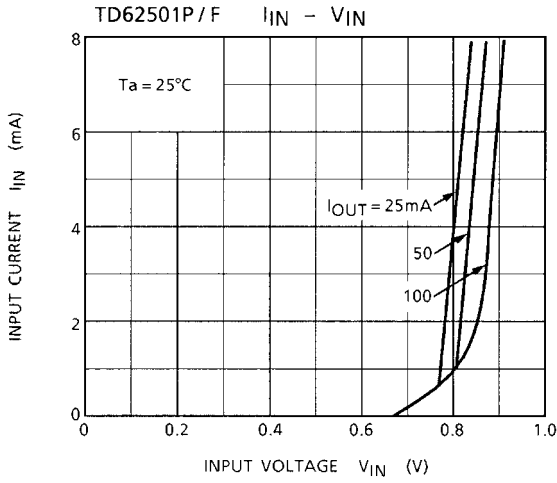

PACKAGE DIMENSIONS

DIP16-P-300-2.54A

Unit: mm

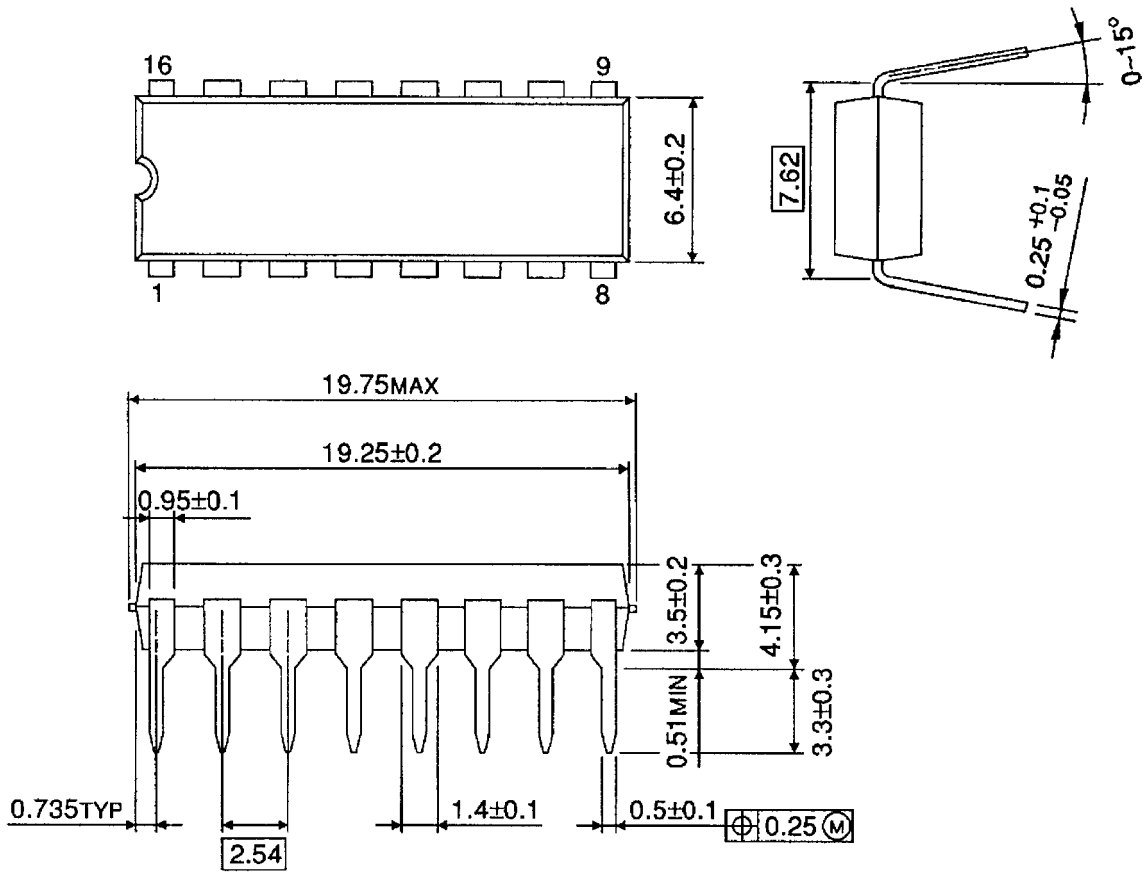

Weight: 1.11 g (Typ.)

PACKAGE DIMENSIONS

SOP16-P-225-1.27

Unit: mm

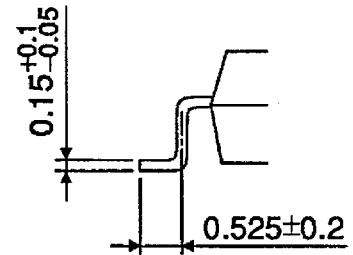
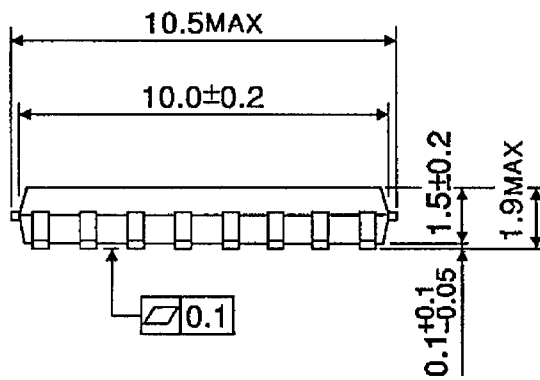
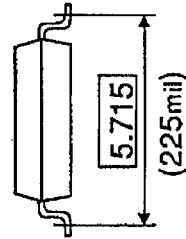
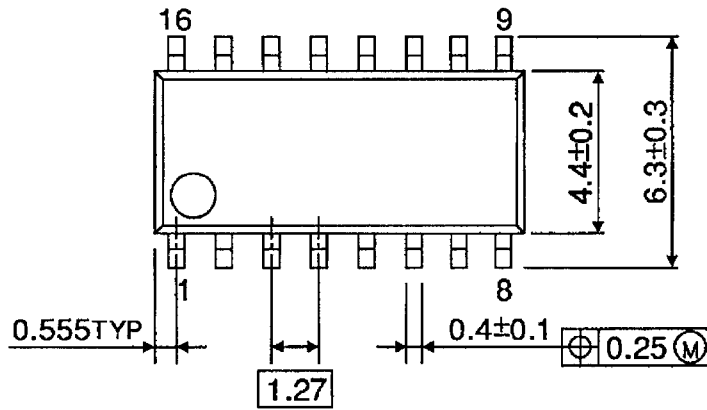

Weight: 0.16 g (Typ.)

RESTRICTIONS ON PRODUCT USE

000707EBA

- TOSHIBA is continually working to improve the quality and reliability of its products. Nevertheless, semiconductor devices in general can malfunction or fail due to their inherent electrical sensitivity and vulnerability to physical stress. It is the responsibility of the buyer, when utilizing TOSHIBA products, to comply with the standards of safety in making a safe design for the entire system, and to avoid situations in which a malfunction or failure of such TOSHIBA products could cause loss of human life, bodily injury or damage to property.
In developing your designs, please ensure that TOSHIBA products are used within specified operating ranges as set forth in the most recent TOSHIBA products specifications. Also, please keep in mind the precautions and conditions set forth in the "Handling Guide for Semiconductor Devices," or "TOSHIBA Semiconductor Reliability Handbook" etc..
- The TOSHIBA products listed in this document are intended for usage in general electronics applications (computer, personal equipment, office equipment, measuring equipment, industrial robotics, domestic appliances, etc.). These TOSHIBA products are neither intended nor warranted for usage in equipment that requires extraordinarily high quality and/or reliability or a malfunction or failure of which may cause loss of human life or bodily injury ("Unintended Usage"). Unintended Usage include atomic energy control instruments, airplane or spaceship instruments, transportation instruments, traffic signal instruments, combustion control instruments, medical instruments, all types of safety devices, etc.. Unintended Usage of TOSHIBA products listed in this document shall be made at the customer's own risk.
- The products described in this document are subject to the foreign exchange and foreign trade laws.
- The information contained herein is presented only as a guide for the applications of our products. No responsibility is assumed by TOSHIBA CORPORATION for any infringements of intellectual property or other rights of the third parties which may result from its use. No license is granted by implication or otherwise under any intellectual property or other rights of TOSHIBA CORPORATION or others.
- The information contained herein is subject to change without notice.