

TOSHIBA BIPOLAR DIGITAL INTEGRATED CIRCUIT SILICON MONOLITHIC

**TD62591AP,TD62592AP,TD62593AP,TD62594AP**  
**TD62595AP,TD62595AF,TD62596AP,TD62596AF**  
**TD62597AP,TD62597AF,TD62598AP,TD62598AF**

## 8CH SINGLE DRIVER

The TD62591AP Series are comprised of eight NPN Transistor Arrays.  
 Applications include relay, hammer, lamp and display (LED) drivers.

### FEATURES

- Output current (single output) 200 mA (Max)
- High sustaining voltage output 50V (Min)
- Low saturation voltage  $V_{CE(sat)} = 0.8\text{ V}$
- @ $I_{out} = 150\text{mA}$ -inputs compatible with various type logic.
  - TD62591, TD62595AP, TD62595AF : external.  
general purpose
  - TD62592, TD62596AP, TD62596AF : 10.5 k $\Omega$  + 7V  
zener diode 14~25 V  
PMOS
  - TD62593, TD62597AP, TD62597AF : 2.7 k $\Omega$   
TTL, 5 V CMOS
  - TD62594, TD62598AP, TD62598AF : 10.5 k $\Omega$   
6~15 V PMOS, CMOS
- Package type-AP : DIP-18pin
- Package type-AF : SOP-18pin

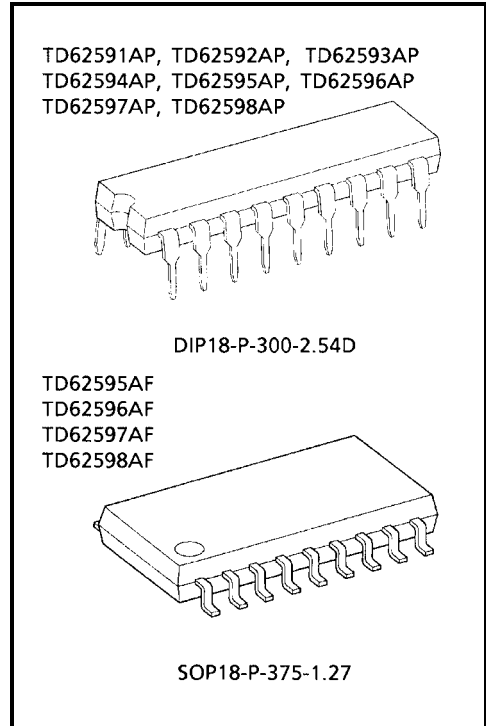

Weight  
 DIP18-P-300-2.54D : 1.47 g (Typ.)  
 SOP18-P-375-1.27 : 0.5 g (Typ.)

### PIN CONNECTION (TOP VIEW)

TD62591AP, TD62592AP, TD62593AP, TD62594AP

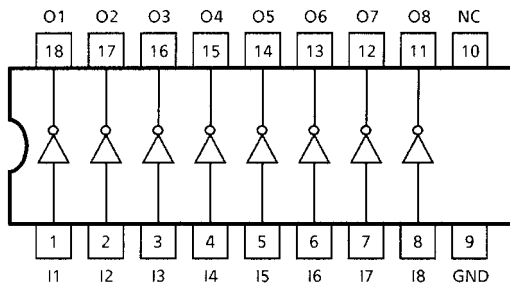

TD62595AP, TD62595AF, TD62596AP, TD62596AF  
 TD62597AP, TD62597AF, TD62598AP, TD62598AF

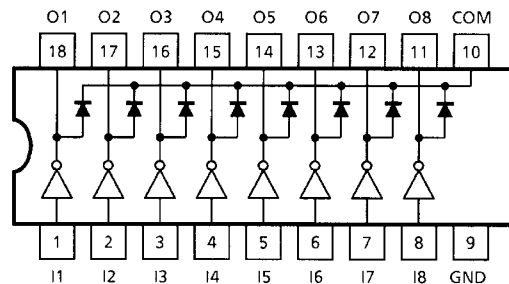

## SCHEMATICS (EACH DRIVER)

TD62591AP

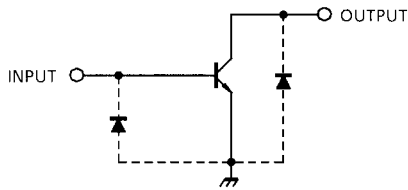

TD62592AP, TD62593AP, TD62594AP

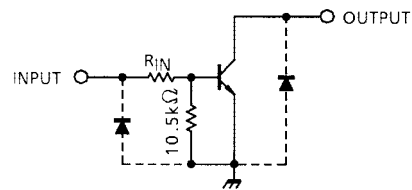

TD62592AP  $R_{IN} = 10.5k\Omega + V_Z = 7V$   
 TD62593AP  $R_{IN} = 2.7k\Omega$   
 TD62594AP  $R_{IN} = 10.5k\Omega$

TD62595AP, TD62595AF

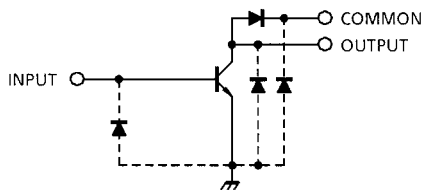

TD62596AP, TD62596AF, TD62597AP,  
 TD62597AF, TD62598AP, TD62598AF

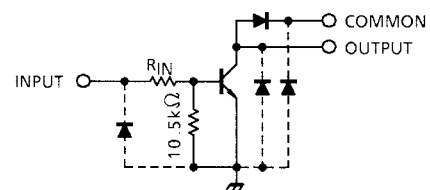

TD62596AP  $R_{IN} = 10.5k\Omega + V_Z = 7V$   
 TD62597AP  $R_{IN} = 2.7k\Omega$   
 TD62598AP  $R_{IN} = 10.5k\Omega$

Note: The input and output parasitic diodes cannot be used as clamp diodes.

## MAXIMUM RATINGS ( $T_a = 25^\circ\text{C}$ )

CHARACTERISTIC	SYMBOL	RATING	UNIT
Collector-Emitter Voltage	$V_{CEO}$	50	V
Collector-Base Voltage	$V_{CBO}$	50	V
Clamp Diode Reverse Voltage	$V_R$ (Note 1)	50	V
Collector Current	$I_C$	200	mA / ch
Input Voltage	$V_{IN}$ (Note 2)	-0.5~30	V
Input Current	$I_{IN}$ (Note 3)	25	mA
Power Dissipation	$P_D$ (Note 4)	0.96 (Note 5) / 1.47	W
Operating Temperature	$T_{opr}$	-40~85	$^\circ\text{C}$
Storage Temperature	$T_{stg}$	-55~150	$^\circ\text{C}$

Note 1: Except TD62591~TD62594AP

Note 2: Except TD62591AP, TD62595AP, TD62595AF

Note 3: Only TD62591AP, TD62595AP, TD62595AF

Note 4: Delated above  $25^\circ\text{C}$  in the proportion of  $11.7\text{mW} / ^\circ\text{C}$  (AP-Type),  $7.7\text{mW} / ^\circ\text{C}$  (F, AF-Type)

Note 5: SOP-18pin

## RECOMMENDED OPERATING CONDITIONS (Ta = -40~85°C)

CHARACTERISTIC		SYMBOL	CONDITION	MIN	TYP.	MAX	UNIT
Collector-Emitter Voltage		$V_{CEO}$	—	0	—	50	V
Collector-Base Voltage		$V_{CBO}$	—	0	—	50	V
Collector Current		$I_C$	—	0	—	150	mA / ch
Clamp Diode Reverse Voltage		$V_R$	(Note1)	7	—	50	V
Input Voltage		$V_{IN}$	(Note2)	0	—	25	V
Input Current		$I_{IN}$	(Note3)	0	—	10	mA
Input Voltage (Output On)	TD62592 TD62596	$V_{IN (ON)}$	—	14.0	—	25	V
	TD62593 TD62597			2.4	—	25	
	TD62594 TD62598			7.0	—	25	
Power Dissipation	AP	$P_D$	—	—	0.52	W	
	AF		—	—	0.355		

## ELECTRICAL CHARACTERISTICS (Ta = 25°C unless otherwise noted)

CHARACTERISTIC		SYMBOL	TEST CIR-CUIT	TEST CONDITION	MIN	TYP.	MAX	UNIT
Output Leakage Current		$I_{CEX}$	1	$V_{CE} = 50\text{ V}, V_{IN} = 0$	—	—	10	$\mu\text{A}$
Collector-Emitter Saturation Voltage		$V_{CE (sat)}$	2	$I_C = 10\text{ mA}, I_{IN} = 0.4\text{ mA}$	—	—	0.2	V
				$I_C = 150\text{ mA}, I_{IN} = 3.0\text{ mA}$	—	—	0.8	
DC Current Transfer Ratio		$h_{FE}$	2	$V_{CE} = 10\text{ V}$ $I_C = 10\text{ mA}$	(Note 3) 70	—	—	—
				(Note 2) 50	—	—		
Input Current	TD62591 TD62595	$I_{IN (ON)}$	3	$I_C = 50\text{ mA}$	—	—	0.65	mA
	TD62592 TD62596			$V_{IN} = 14\text{ V}, I_C = 50\text{ mA}$	—	—	0.9	
	TD62593 TD62597			$V_{IN} = 2.4\text{ V}, I_C = 50\text{ mA}$	—	—	0.9	
	TD62594 TD62598			$V_{IN} = 7.0\text{ V}, I_C = 50\text{ mA}$	—	—	0.9	
Turn-On Delay		$t_{ON}$	4	$V_{OUT} = 50\text{ V}, R_L = 330\ \Omega$	—	0.1	—	$\mu\text{s}$
Turn-Off Delay		$t_{OFF}$			—	0.3	—	$\mu\text{s}$

Note 1: Except TD62591~TD62594AP

Note 2: Except TD62591AP, TD62595AP, TD62595AF

Note 3: Only TD62591AP, TD62595AP, TD62595AF

**TEST CIRCUIT**

**1. I<sub>CEX</sub>**

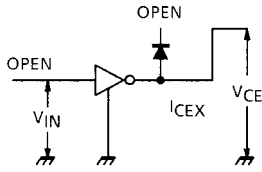

**2. h<sub>FE</sub>, V<sub>CE</sub> (sat)**

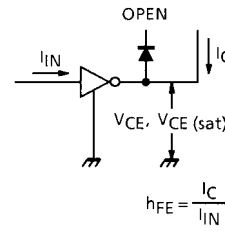

**3. V<sub>IN</sub> (ON)**

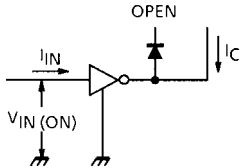

**4. t<sub>ON</sub>, t<sub>OFF</sub>**

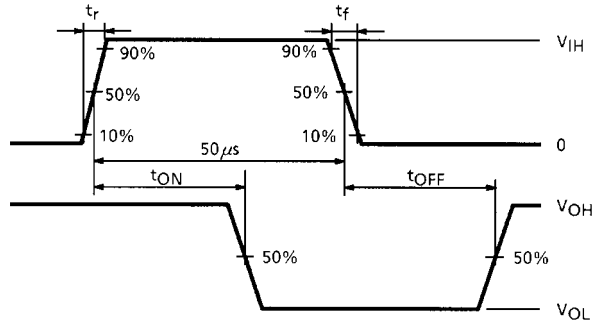
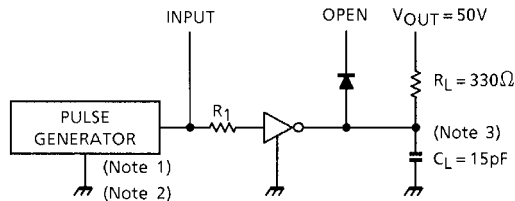

Note 1: Pulse width 50 μs, duty cycle 10%  
 Output impedance 50 Ω, t<sub>r</sub> ≤ 5 ns, t<sub>f</sub> ≤ 10 ns  
 Note 2: See below

**Input Condition**

TYPE NUMBER	R <sub>IN</sub>	V <sub>IH</sub>
TD62591AP, TD62595AP, TD62595AF	2.7 kΩ	3 V
TD62592AP, TD62596AP, TD62596AF	0 Ω	15 V
TD62593AP, TD62597AP, TD62597AF	0 Ω	3 V
TD62594AP, TD62598AP, TD62598AF	0 Ω	10 V

Note 3: C<sub>L</sub> includes probe and jig capacitance

**PRECAUTIONS for USING**

This IC does not integrate protection circuits such as overcurrent and overvoltage protectors. Thus, if excess current or voltage is applied to the IC, the IC may be damaged. Please design the IC so that excess current or voltage will not be applied to the IC. Utmost care is necessary in the design of the output line, VCC and GND line since IC may be destroyed due to short-circuit between outputs, air contamination fault, or fault by improper grounding.

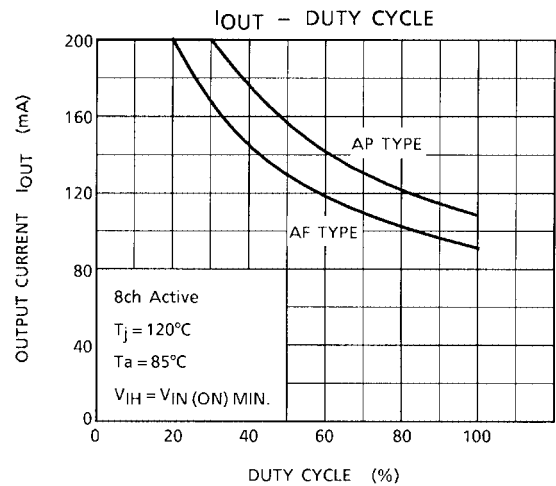
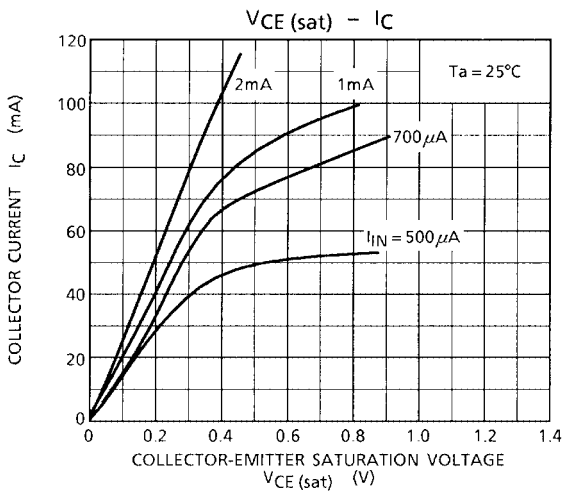
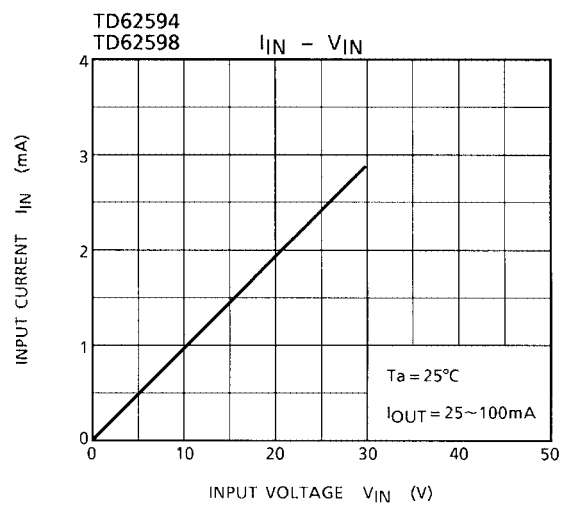
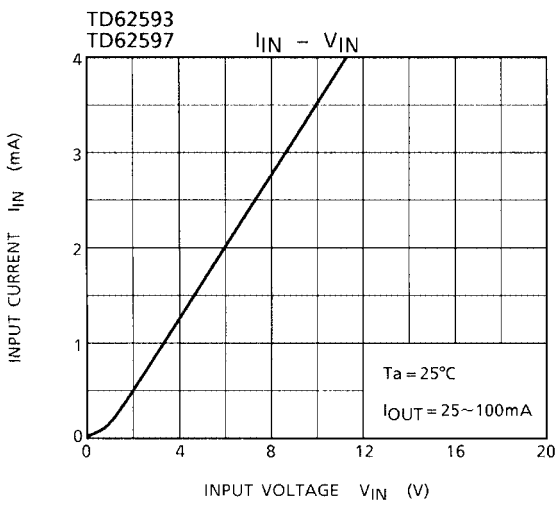
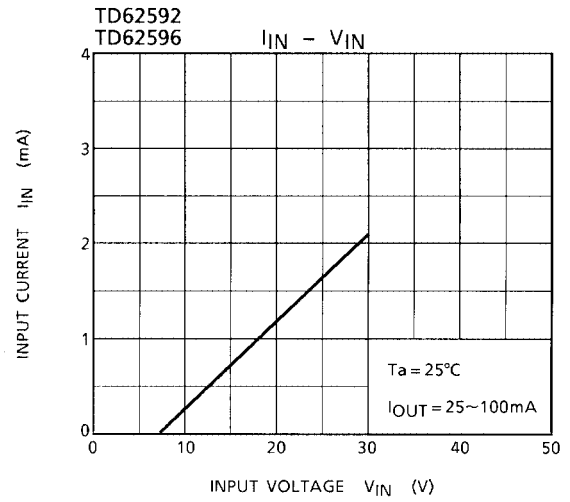
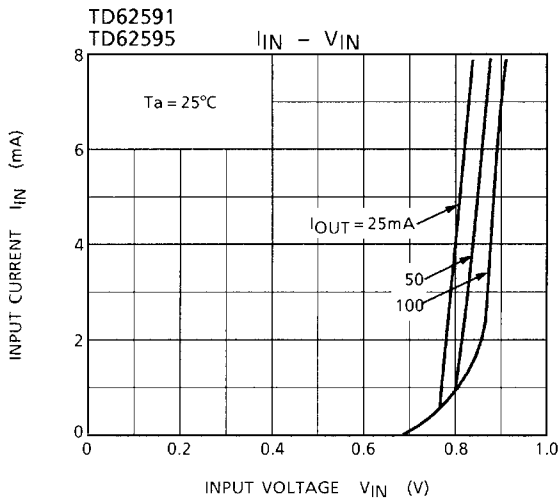

### STATIC CHARACTERISTICS

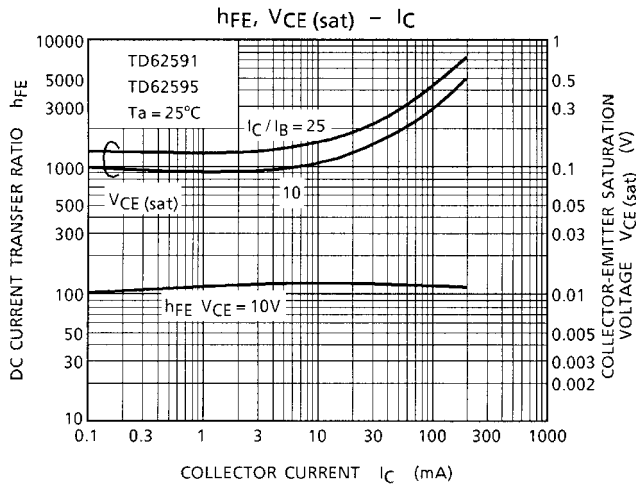
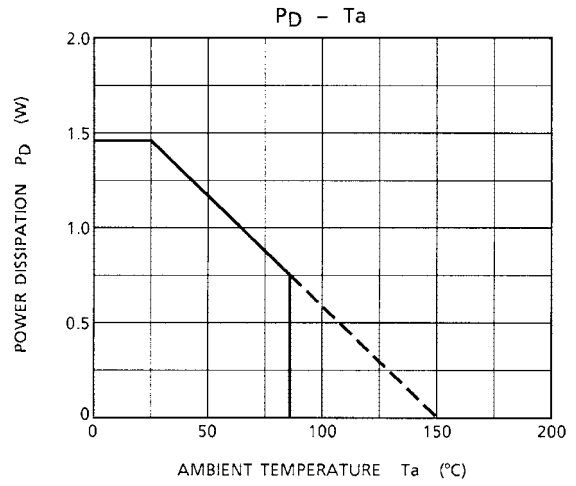
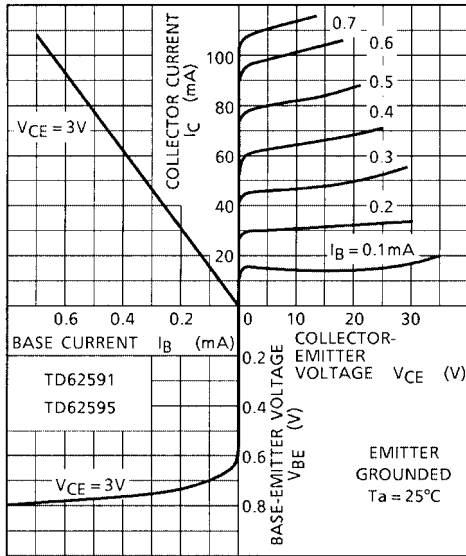

## PACKAGE DIMENSIONS

DIP18-P-300-2.54D

Unit: mm

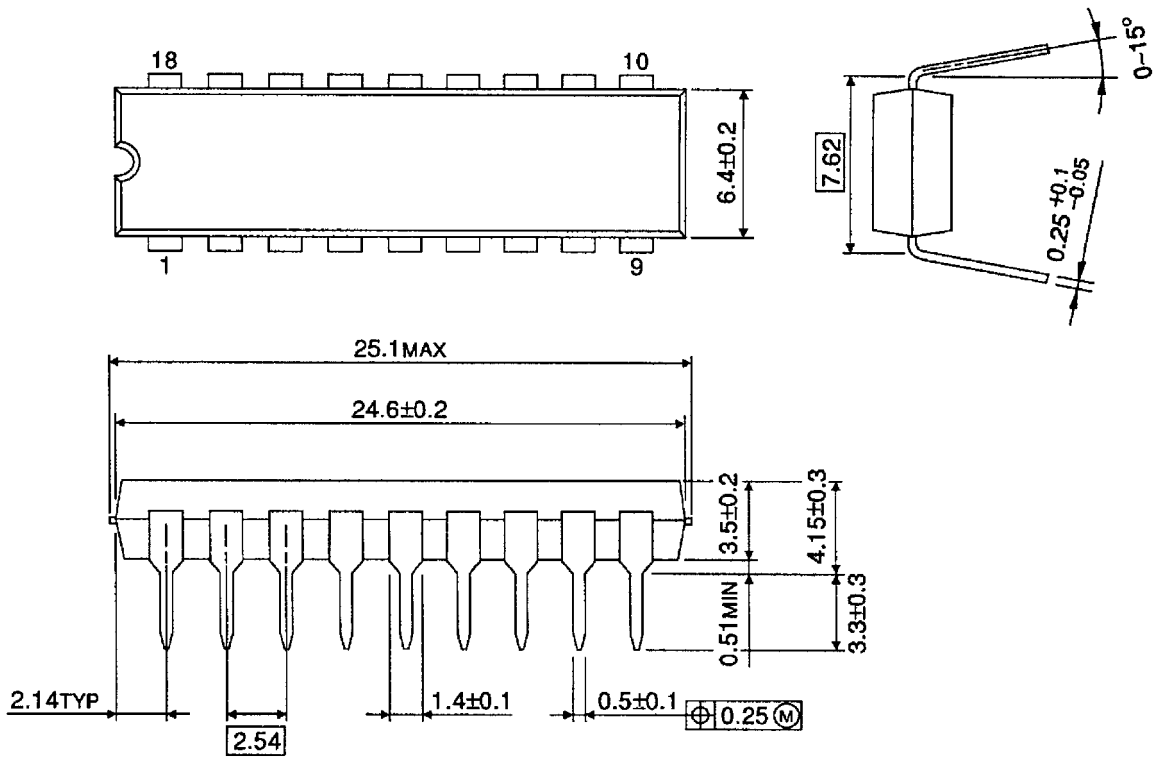

Weight: 1.47 g (Typ.)

## PACKAGE DIMENSIONS

SOP18-P-375-1.27

Unit: mm

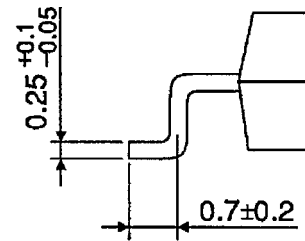
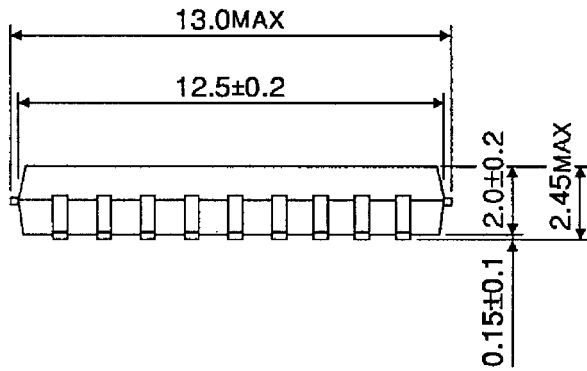
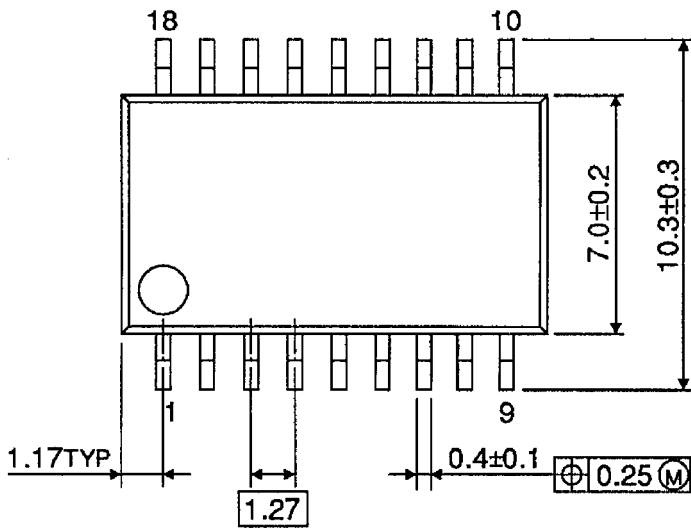

Weight: 0.50 g (Typ.)



**RESTRICTIONS ON PRODUCT USE**

000707EBA

- TOSHIBA is continually working to improve the quality and reliability of its products. Nevertheless, semiconductor devices in general can malfunction or fail due to their inherent electrical sensitivity and vulnerability to physical stress. It is the responsibility of the buyer, when utilizing TOSHIBA products, to comply with the standards of safety in making a safe design for the entire system, and to avoid situations in which a malfunction or failure of such TOSHIBA products could cause loss of human life, bodily injury or damage to property.  
In developing your designs, please ensure that TOSHIBA products are used within specified operating ranges as set forth in the most recent TOSHIBA products specifications. Also, please keep in mind the precautions and conditions set forth in the "Handling Guide for Semiconductor Devices," or "TOSHIBA Semiconductor Reliability Handbook" etc..
- The TOSHIBA products listed in this document are intended for usage in general electronics applications (computer, personal equipment, office equipment, measuring equipment, industrial robotics, domestic appliances, etc.). These TOSHIBA products are neither intended nor warranted for usage in equipment that requires extraordinarily high quality and/or reliability or a malfunction or failure of which may cause loss of human life or bodily injury ("Unintended Usage"). Unintended Usage include atomic energy control instruments, airplane or spaceship instruments, transportation instruments, traffic signal instruments, combustion control instruments, medical instruments, all types of safety devices, etc.. Unintended Usage of TOSHIBA products listed in this document shall be made at the customer's own risk.
- The products described in this document are subject to the foreign exchange and foreign trade laws.
- The information contained herein is presented only as a guide for the applications of our products. No responsibility is assumed by TOSHIBA CORPORATION for any infringements of intellectual property or other rights of the third parties which may result from its use. No license is granted by implication or otherwise under any intellectual property or other rights of TOSHIBA CORPORATION or others.
- The information contained herein is subject to change without notice.