

TOSHIBA BIPOLAR DIGITAL INTEGRATED CIRCUIT SILICON MONOLITHIC

TD62781AP,TD62781F,TD62781AF TD62782AP,TD62782F,TD62782AF

8CH HIGH-VOLTAGE SOURCE DRIVER

The TD62781AP / F / AF Series are comprised of eight source current Transistor Array.

These drivers are specifically designed for fluorescent display applications.

Applications include relay, hammer and lamp drivers.

FEATURES

- High output voltage Type-AP, AF: $V_{OUT} = 60\text{ V (Min)}$
 Type-F : $V_{OUT} = 35\text{ V (Min)}$
- Output current (single output) $I_{OUT} = -50\text{ mA / ch (Max)}$
- Pull-down resistors / each output
- Single supply voltage
- Input compatible with various types of logic

TYPE	DESIGNATION
TD62781AP / F / AF	TTL, 5 V CMOS
TD62782AP / F / AF	6~15 V PMOS CMOS

PIN CONNECTION (TOP VIEW)

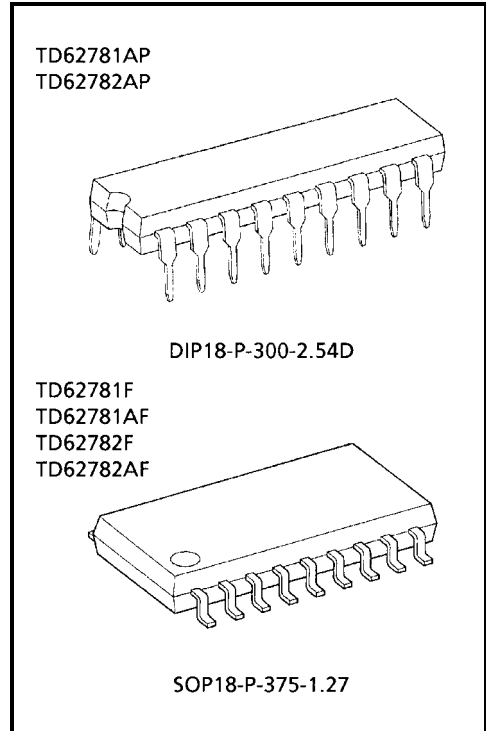
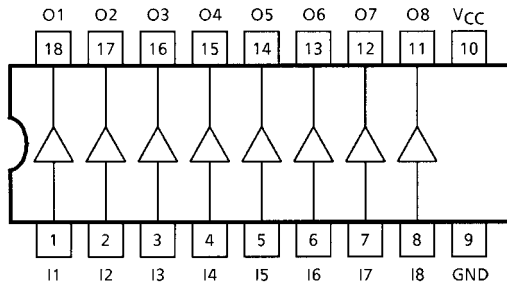

Weight
 DIP18-P-300-2.54D : 1.47 g (Typ.)
 SOP18-P-375-1.27 : 0.41 g (Typ.)

SCHEMATICS (EACH DRIVER)

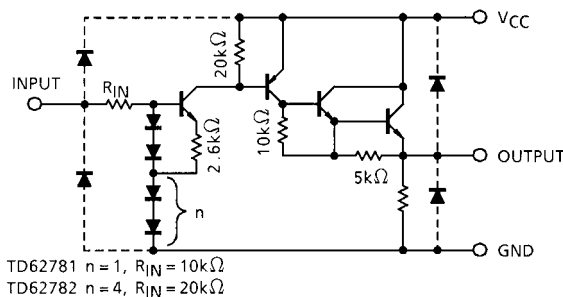

Note: The input and output parasitic diodes cannot be used as clamp diodes.

MAXIMUM RATINGS (Ta = 25°C)

CHARACTERISTIC		SYMBOL	RATING	UNIT
Supply Voltage	AP / AF	V _{CC}	60	V
	F		35	
Output Voltage		V _{OUT}	V _{CC}	V
Output Current		I _{OUT}	-50	mA / ch
Input Voltage		V _{IN}	20	V
Power Dissipation	AP	P _D (Note)	1.47	W
	F / AF		0.96	
Operating Temperature		T _{opr}	-40~85	°C
Storage Temperature		T _{stg}	-55~150	°C

Note: Delated above 25°C in the proportion 11.7 mW / °C (AP Type), 7.7 mW / °C (F, AF Type).

RECOMMENDED OPERATING CONDITIONS (Ta = -40~85°C)

CHARACTERISTIC		SYMBOL	CONDITION	MIN	TYP.	MAX	UNIT
Supply Voltage	TD62781AP, TD62781AF	V _{CC}	—	4.5	—	55	V
	TD62781F			4.5	—	35	
	TD62782AP, TD62782AF			6.0	—	55	
	TD62782F			6.0	—	35	
Output Voltage		V _{OUT}	—	0	—	V _{CC}	V
Output Current		I _{OUT}	—	0	—	-40	mA / ch
Input Voltage	TD62781	V _{IN}	—	0	—	7	V
	TD62782			0	—	15	
Power Dissipation	AP	P _D	—	—	—	0.52	W
	AF / F			—	—	0.35	

ELECTRICAL CHARACTERISTICS (Ta = 25°C)

CHARACTERISTIC			SYMBOL	TEST CIR-CUIT	TEST CONDITION	MIN	TYP.	MAX	UNIT
Input Voltage	"H" Level	TD62781	V _{IH}	1	—	2.0	—	—	V
		TD62782				4.5	—	—	
	"L" Level	TD62781	V _{IL}	1	—	0	—	0.8	V
		TD62782				0	—	2.0	
Input Current	"H" Level	TD62781	I _{IH}	2	V _{IN} = 2.4 V	—	40	75	μA
		TD62782			V _{IN} = 7.5 V	—	170	250	
Output Current		"H" Level	I _{OL}	3	—	—	200	—	μA
Output Voltage		"H" Level	V _{OH}	4	I _{OUT} = -40 mA, V _{IN} = V _{IH} MIN.	V _{CC} -2.5	V _{CC} -1.7	—	V
		"L" Level	V _{OL}		I _{OUT} = 0, V _{IN} = V _{IL} MIN.	—	50	250	mV
Supply Current			I _{CC} (ON)	1	V _{CC} = 55 V, V _{IN} = V _{IH} MIN. (Note)	—	—	20	mA
			I _{CC} (OFF)		V _{CC} = 55 V, V _{IN} = V _{IL} MAX. (Note)	—	—	1	
Turn-On Delay			t _{ON}	5	V _{CC} = 55 V, C _L = 15 pF (Note)	—	0.2	—	μs
Turn-Off Delay			t _{OFF}			—	6.0	—	

Note: V_{CC} = 35 V for Type-F

TEST CIRCUIT

1. V_{IH} , V_{IL} , I_{CC}

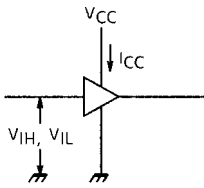

2. I_{IH}

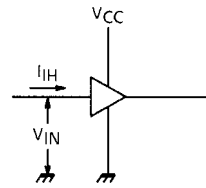

3. I_{OL}

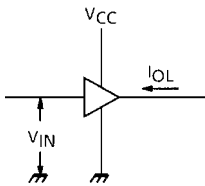

4. V_{OH} , V_{OL}

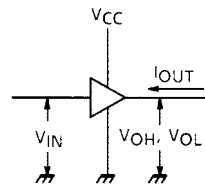

5. t_{ON} , t_{OFF}

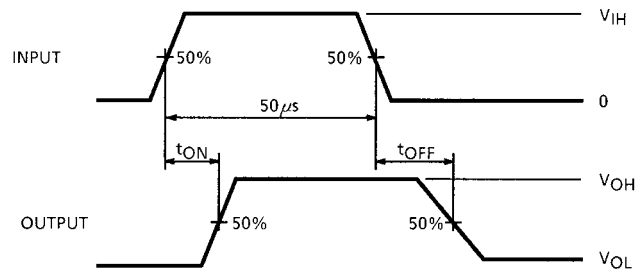
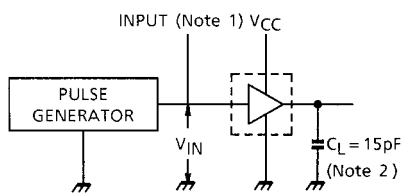

Note 1: Pulse Width 50 μ s, Duty Cycle 10%

Output Impedance 50 Ω , $t_r \leq 100$ ns, $t_f \leq 100$ ns

Note 2: C_L includes probe and jig capacitance.

PRECAUTIONS for USING

This IC does not integrate protection circuits such as overcurrent and overvoltage protectors.

Thus, if excess current or voltage is applied to the IC, the IC may be damaged. Please design the IC so that excess current or voltage will not be applied to the IC.

Utmost care is necessary in the design of the output line, VCC and GND line since IC may be destroyed due to short-circuit between outputs, air contamination fault, or fault by improper grounding.

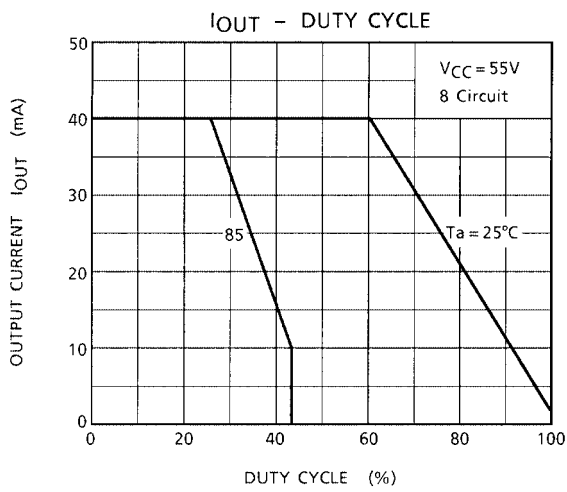
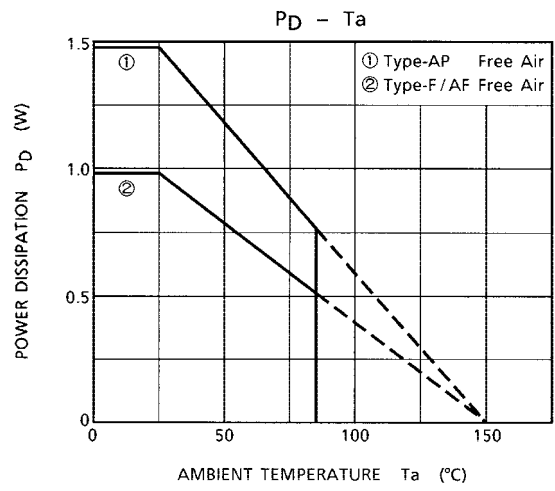
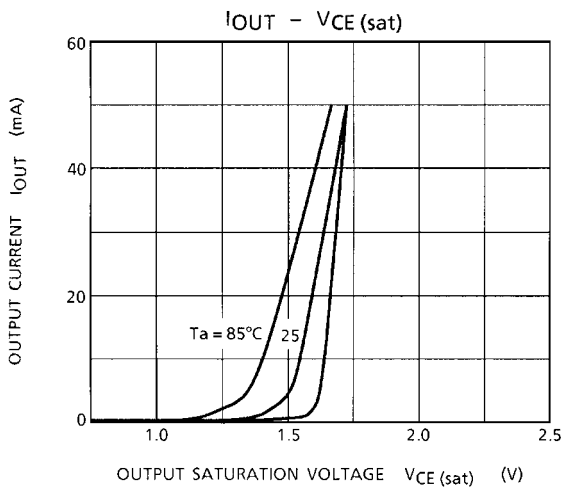
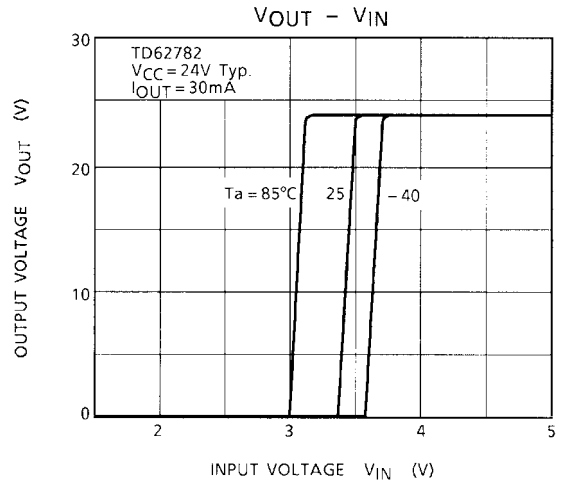
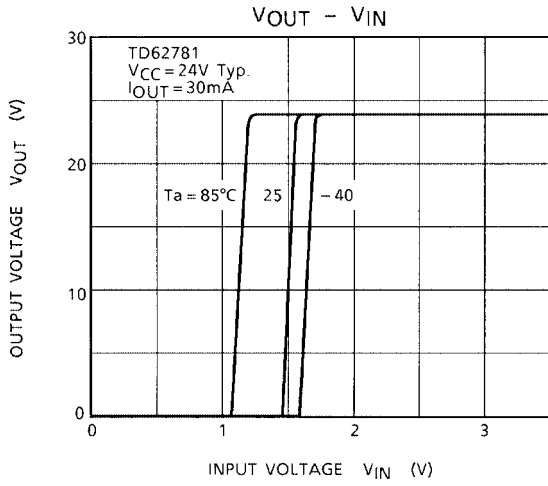

PACKAGE DIMENSIONS

DIP18-P-300-2.54D

Unit: mm

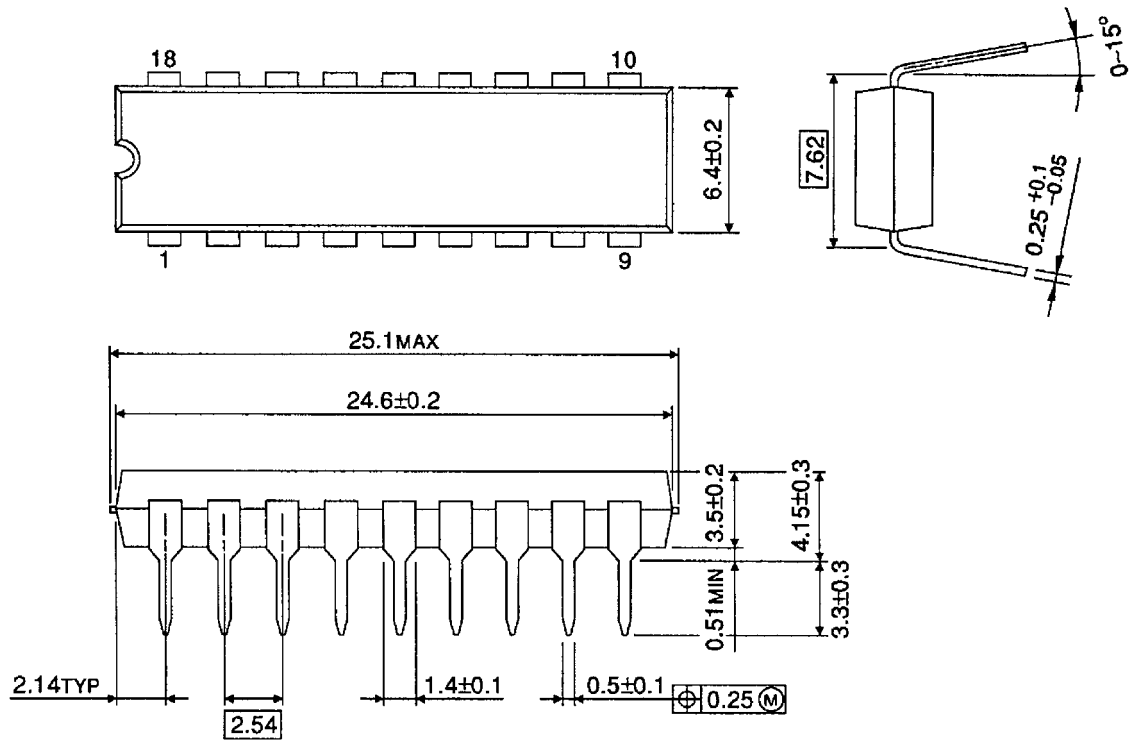

Weight: 1.47 g (Typ.)

PACKAGE DIMENSIONS

SOP18-P-375-1.27

Unit: mm

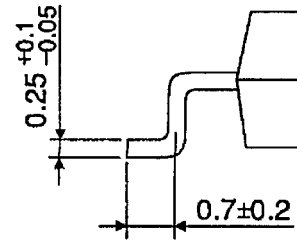
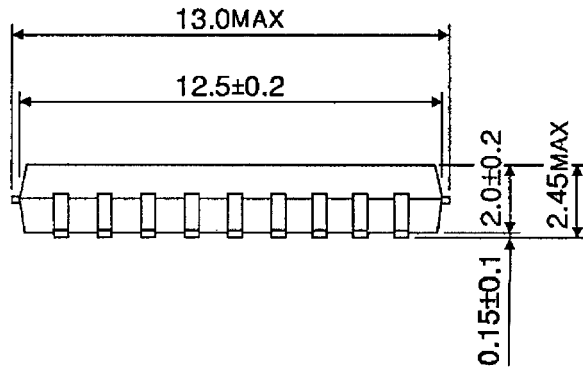
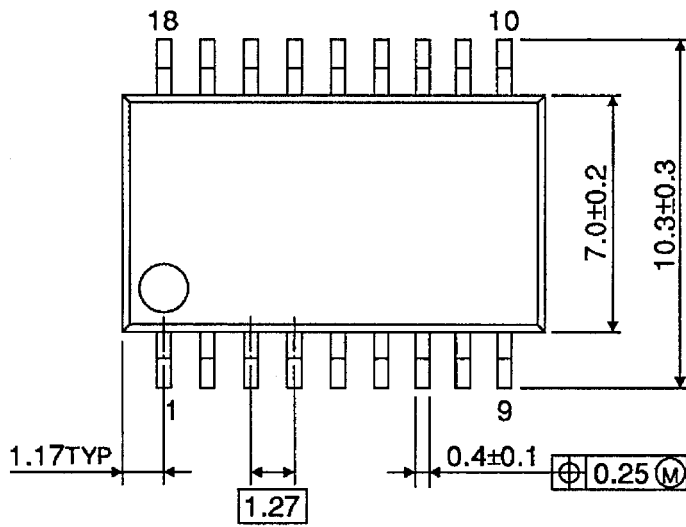

Weight: 0.41 g (Typ.)

RESTRICTIONS ON PRODUCT USE

000707EBA

- TOSHIBA is continually working to improve the quality and reliability of its products. Nevertheless, semiconductor devices in general can malfunction or fail due to their inherent electrical sensitivity and vulnerability to physical stress. It is the responsibility of the buyer, when utilizing TOSHIBA products, to comply with the standards of safety in making a safe design for the entire system, and to avoid situations in which a malfunction or failure of such TOSHIBA products could cause loss of human life, bodily injury or damage to property.
In developing your designs, please ensure that TOSHIBA products are used within specified operating ranges as set forth in the most recent TOSHIBA products specifications. Also, please keep in mind the precautions and conditions set forth in the "Handling Guide for Semiconductor Devices," or "TOSHIBA Semiconductor Reliability Handbook" etc..
- The TOSHIBA products listed in this document are intended for usage in general electronics applications (computer, personal equipment, office equipment, measuring equipment, industrial robotics, domestic appliances, etc.). These TOSHIBA products are neither intended nor warranted for usage in equipment that requires extraordinarily high quality and/or reliability or a malfunction or failure of which may cause loss of human life or bodily injury ("Unintended Usage"). Unintended Usage include atomic energy control instruments, airplane or spaceship instruments, transportation instruments, traffic signal instruments, combustion control instruments, medical instruments, all types of safety devices, etc.. Unintended Usage of TOSHIBA products listed in this document shall be made at the customer's own risk.
- The products described in this document are subject to the foreign exchange and foreign trade laws.
- The information contained herein is presented only as a guide for the applications of our products. No responsibility is assumed by TOSHIBA CORPORATION for any infringements of intellectual property or other rights of the third parties which may result from its use. No license is granted by implication or otherwise under any intellectual property or other rights of TOSHIBA CORPORATION or others.
- The information contained herein is subject to change without notice.