

TOSHIBA BIPOLAR DIGITAL INTEGRATED CIRCUIT SILICON MONOLITHIC

TD62786AP, TD62786F, TD62786AF TD62787AP, TD62787F, TD62787AF

8CH HIGH-VOLTAGE SOURCE DRIVER

The TD62786AP / F / AF series are eight channel hux non-inverting source current transistor array. All units feature integral clamp diodes for switching inductive loads. Applications include relay, hammer and lamp drivers.

FEATURES

- High output voltage type-AP, AF : $V_{CE(SUS)} = 50\text{ V (Min)}$
type-F : $V_{CE(SUS)} = 35\text{ V (Min)}$
- Output current (single output) : $I_{OUT} = -500\text{ mA / ch (Max)}$
- Output clamp diodes
- Single supply voltage
- Input compatible with TTL, 5 V CMOS
- Low level active input
- Package type-AP : DIP-18 pin
- Package type-F, AF: SOP-18 pin

PIN CONNECTION (TOP VIEW)

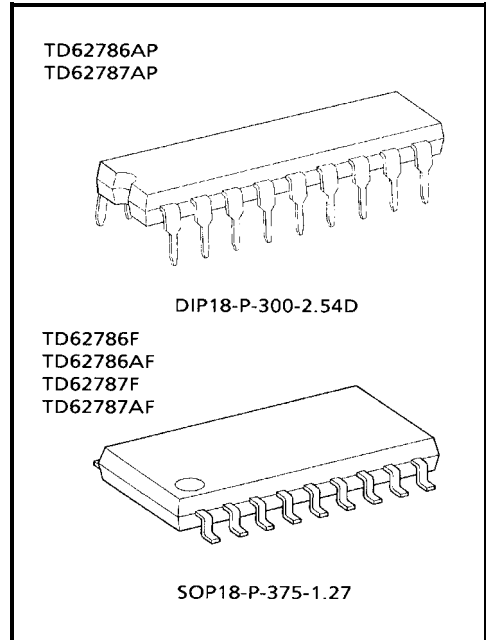
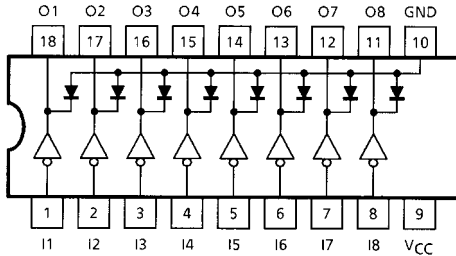

Weight
 DIP18-P-300-2.54D : 1.47 g (Typ.)
 SOP18-P-375-1.27 : 0.41 g (Typ.)

SCHEMATICS (EACH DRIVER)

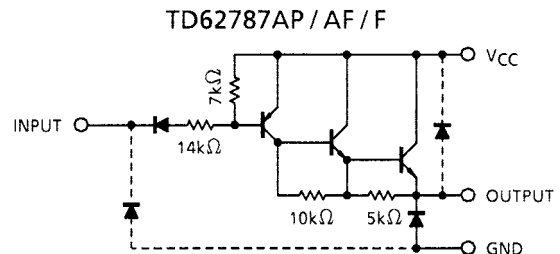
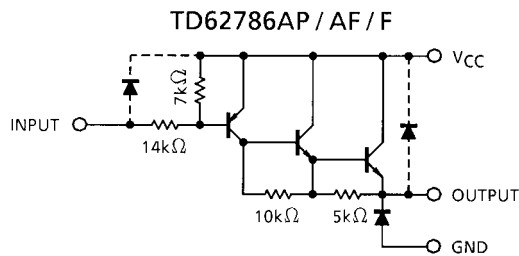

Note: The input and output parasitic diodes cannot be used as clamp diodes.

MAXIMUM RATINGS (Ta = 25°C)

CHARACTERISTIC		SYMBOL	RATING	UNIT
Supply Voltage	AP / AF	V _{CC} -V _{GND}	50	V
	F		35	
Output Sustaining Voltage	AP / AF	V _{OUT}	-50	V
	F		-35	
Output Current		I _{OUT}	-500	mA / ch
Input Voltage		V _{IN} (Note 1)	-30~0.5	V
Input Voltage		V _{IN} (Note 2)	V _{GND} ~7	V
Clamp Diode Forward Current	AP / AF	V _R	50	V
	F		35	
Clamp Diode Forward Current		I _F	500	mA
Power Dissipation	AP	P _D (Note 3)	1.47	W
	F / AF		0.96	
Operating Temperature		T _{opr}	-40~85	°C
Storage Temperature		T _{stg}	-55~150	°C

Note 1: Only TD62786AP / F / AF

Note 2: Only TD62787AP / F / AF

Note 3: Delated above 25°C in the proportion of 11.7 mW / °C (AP Type), 7.7 mW / °C (F, AF Type).

RECOMMENDED OPERATING CONDITIONS (Ta = -40~85°C, V_{CC} = 0 V)

CHARACTERISTIC		SYMBOL	CONDITION	MIN	TYP.	MAX	UNIT
Supply Voltage	AP / AF	V _{CC} -V _{GND}	—	—	—	50	V
	F		—	—	—	35	
Output Voltage	AP / AF	V _{OUT}	—	—	—	-50	V
	F		—	—	—	-35	
Output Current		I _{OUT}	—	—	—	-350	mA / ch
Input Voltage	TD62786	V _{IN}	—	-30	—	0	V
	TD62787		—	V _{GND}	—	7	
Clamp Diode Reverse Voltage	AP / AF	V _R	—	—	—	50	V
	F		—	—	—	35	
Clamp Diode Forward Current		I _F	—	—	—	350	mA
Power Dissipation	AP	P _D	—	—	—	0.52	W
	AF / F		—	—	—	0.35	

ELECTRICAL CHARACTERISTICS (Ta = 25°C, VCC = 0 V)

CHARACTERISTIC		SYMBOL	TEST CIR-CUIT	TEST CONDITION	MIN	TYP.	MAX	UNIT
Output Leakage Current		I_{CEX}	1	$V_{OUT} = V_{GND} = -50\text{ V}$ $T_a = 85^\circ\text{C}$	—	—	-100	μA
Output Saturation Voltage		$V_{CE(sat)}$	2	$V_{IN} = V_{IL, MAX.}$ $I_{OUT} = -100\text{ mA}$	—	—	-1.8	V
				$V_{IN} = V_{IL, MAX.}$ $I_{OUT} = -350\text{ mA}$	—	—	-2.0	
DC Current transfer Ratio		h_{FE}	2	$V_{CC} = 0\text{ V}, V_{CE} = 3\text{ V}$ $I_{OUT} = -350\text{ mA}$	1000	—	—	—
Input Voltage	"H" Level	TD62786	4	—	-1.2	—	0	V
		TD62787			-1.6	—	5.5	
	"L" Level	TD62786			-30	—	-2.8	
		TD62787			V_{GND}	—	-3.7	
Input Current		I_{IL}	—	$V_{CC} = 5.5\text{ V}, V_{IN} = 0.4\text{ V}$	—	—	-0.4	mA
Clamp Diode Reverse Current		I_R	—	$V_R = V_{R, MAX.}, T_a = 85^\circ\text{C}$	—	—	100	μA
Clamp Diode Forward Voltage		V_F	—	—	—	—	2.0	V
Turn-On Delay		t_{ON}	5	$V_{OUT} = -50\text{ V}, R_L = 163\ \Omega$ $C_L = 15\text{ pF}$ (Note)	—	0.2	—	μs
Turn Off Delay		t_{OFF}			—	1.0	—	

Note: $V_{OUT} = -35\text{ V}, R_L = 116\ \Omega$ for Type-F

TEST CIRCUIT

1. I_{CEX}

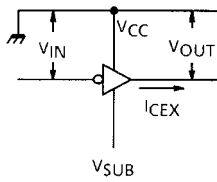

2. $V_{CE(sat)}$, h_{FE}

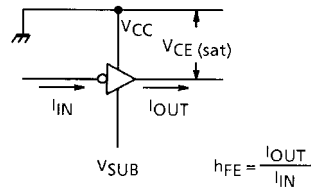

3. $I_{IN(ON)}$, $I_{IN(OFF)}$

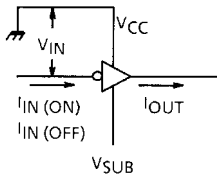

4. $V_{IN(ON)}$, $V_{IN(OFF)}$

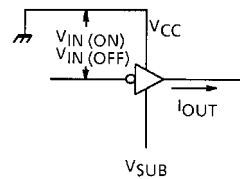

5. t_{ON} , t_{OFF}

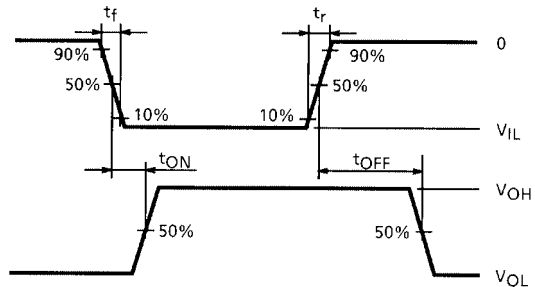
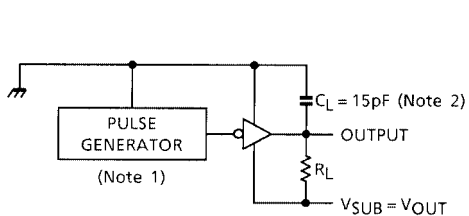

- Note 1: Pulse Width 50 μ s, Duty Cycle 10%
 Output Impedance 50 Ω , $t_r \leq 10$ ns, $t_f \leq 5$ ns
 Note 2: C_L includes probe and jig capacitance.

PRECAUTIONS for USING

This IC does not integrate protection circuits such as overcurrent and overvoltage protectors. Thus, if excess current or voltage is applied to the IC, the IC may be damaged. Please design the IC so that excess current or voltage will not be applied to the IC. Utmost care is necessary in the design of the output line, V_{CC} and GND line since IC may be destroyed due to short-circuit between outputs, air contamination fault, or fault by improper grounding.

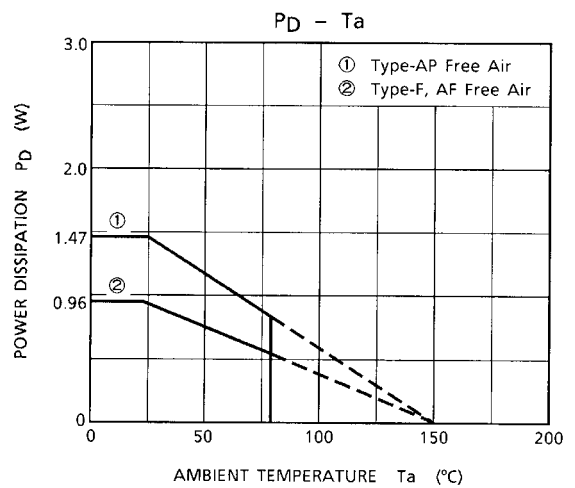
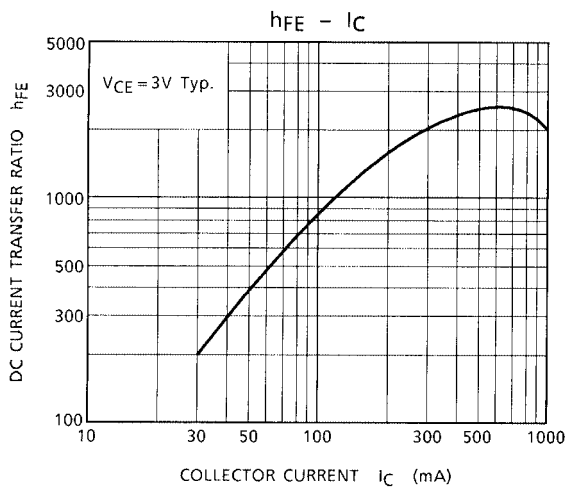
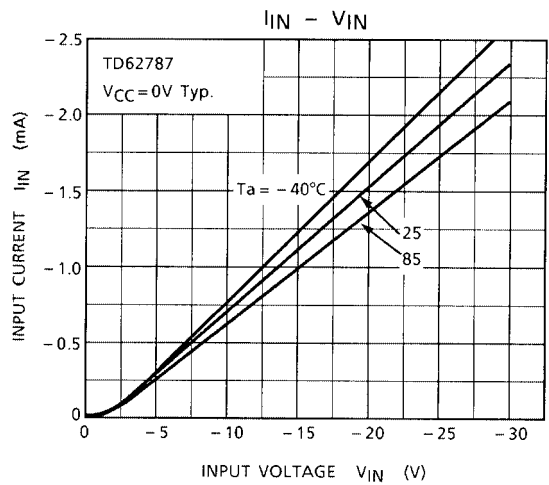
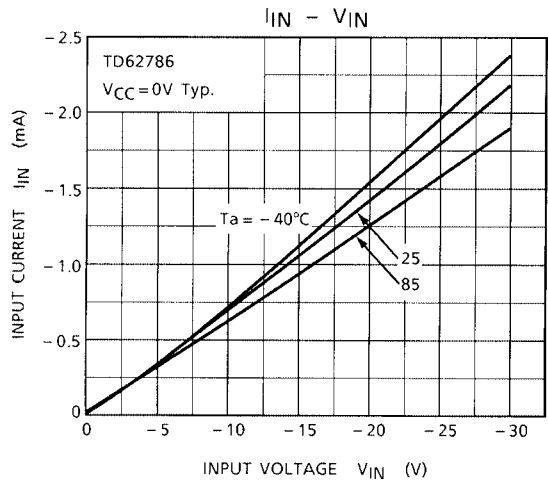
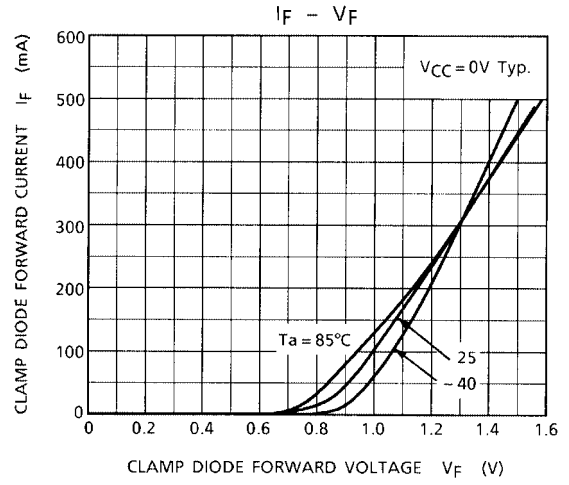
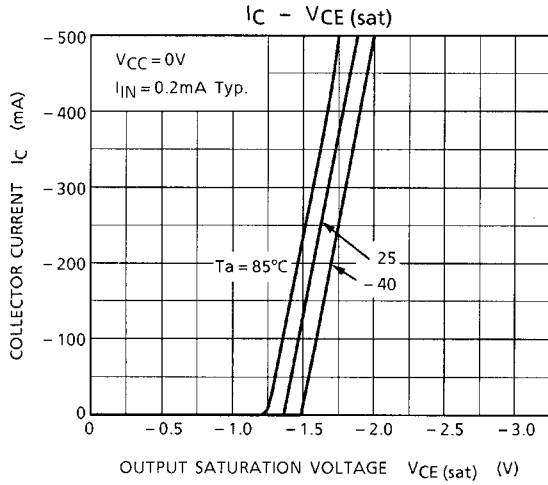

PACKAGE DIMENSIONS

DIP18-P-300-2.54D

Unit: mm

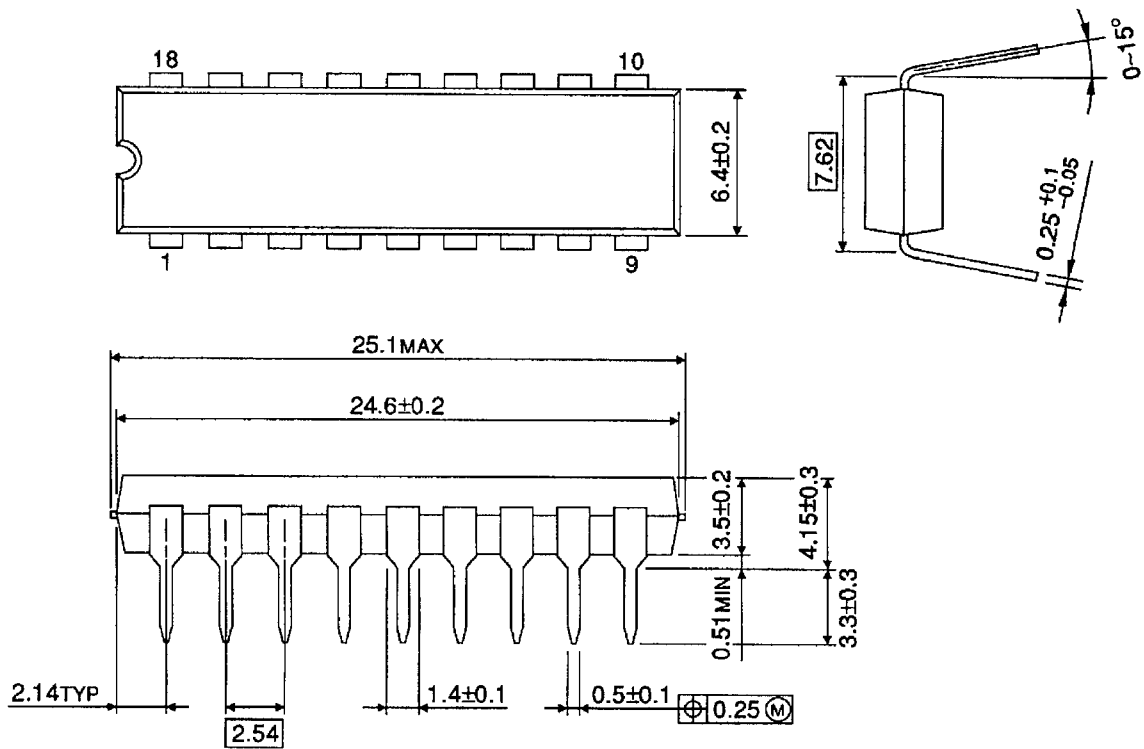

Weight: 1.47 g (Typ.)

PACKAGE DIMENSIONS

SOP18-P-375-1.27

Unit: mm

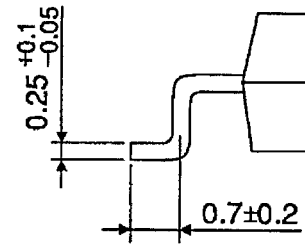
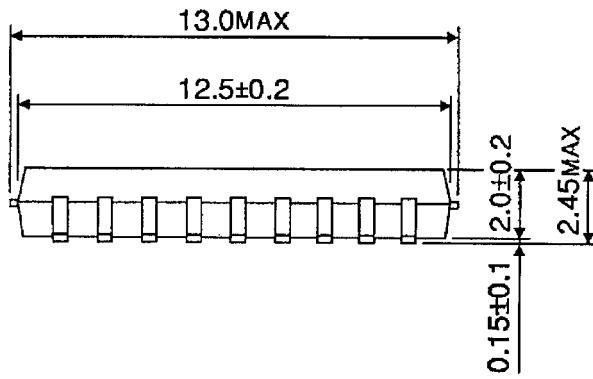
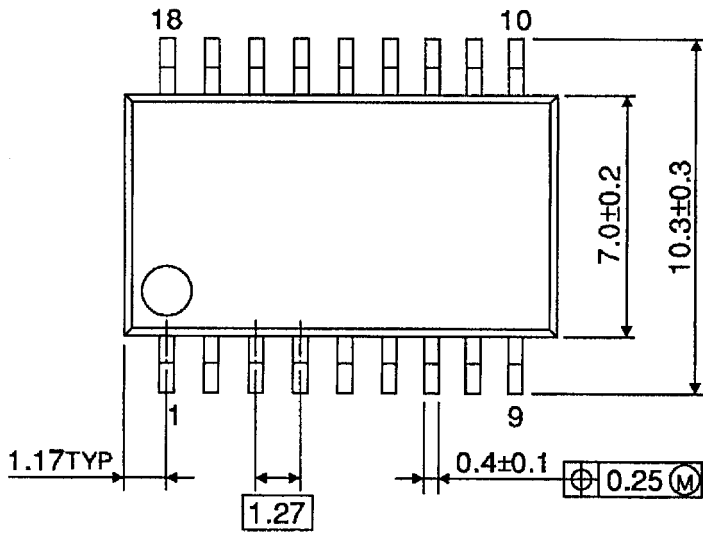

Weight: 0.41 g (Typ.)

RESTRICTIONS ON PRODUCT USE

000707EBA

- TOSHIBA is continually working to improve the quality and reliability of its products. Nevertheless, semiconductor devices in general can malfunction or fail due to their inherent electrical sensitivity and vulnerability to physical stress. It is the responsibility of the buyer, when utilizing TOSHIBA products, to comply with the standards of safety in making a safe design for the entire system, and to avoid situations in which a malfunction or failure of such TOSHIBA products could cause loss of human life, bodily injury or damage to property.
In developing your designs, please ensure that TOSHIBA products are used within specified operating ranges as set forth in the most recent TOSHIBA products specifications. Also, please keep in mind the precautions and conditions set forth in the "Handling Guide for Semiconductor Devices," or "TOSHIBA Semiconductor Reliability Handbook" etc..
- The TOSHIBA products listed in this document are intended for usage in general electronics applications (computer, personal equipment, office equipment, measuring equipment, industrial robotics, domestic appliances, etc.). These TOSHIBA products are neither intended nor warranted for usage in equipment that requires extraordinarily high quality and/or reliability or a malfunction or failure of which may cause loss of human life or bodily injury ("Unintended Usage"). Unintended Usage include atomic energy control instruments, airplane or spaceship instruments, transportation instruments, traffic signal instruments, combustion control instruments, medical instruments, all types of safety devices, etc.. Unintended Usage of TOSHIBA products listed in this document shall be made at the customer's own risk.
- The products described in this document are subject to the foreign exchange and foreign trade laws.
- The information contained herein is presented only as a guide for the applications of our products. No responsibility is assumed by TOSHIBA CORPORATION for any infringements of intellectual property or other rights of the third parties which may result from its use. No license is granted by implication or otherwise under any intellectual property or other rights of TOSHIBA CORPORATION or others.
- The information contained herein is subject to change without notice.