

TRAFFIC CONTROL MESSAGES AND WARNING TONE CIRCUIT

The TDA1589 is for evaluation of operating signals and logic control signals of a traffic control (TC) message decoder.

Features

- mute of non-traffic control stations
- restriction to traffic-control message reception
- LED display driver for MUTE indication
- control output for TC messages minimum volume
- delayed start of warning tone signal on failure of TC transmission. Also to be used to control a start of search tuning
- warning tone generator with automatic level control increasing volume in five steps
- interruption of cassette playback with motor stop during TC messages
- warning tone indicating failure of TC transmission also during cassette playback

QUICK REFERENCE DATA

Supply voltage (pin 10)	V_p	7,5 to 16 V
		typ. 8,5 V
Supply current	I_p	typ. 4,5 mA
Warning tone maximum voltage	$V_{o(p-p)}$	typ. 4,3 V
Output LED driver current (pin 3)	I_3	typ. 30 mA
motor stop current (pin 5)	I_5	typ. 30 mA
motor stop current (pin 6)	I_6	typ. 2 mA
MUTE display current (pin 8)	I_8	typ. 2 mA
start warning tone current (pin 13)	I_{13}	typ. 2 mA
Saturation voltage at output for minimum volume-on (pin 7)	$V_{7\text{ sat}}$	< 0,1 V

PACKAGE OUTLINE

18-lead DIL; plastic (SOT102).

TDA1589

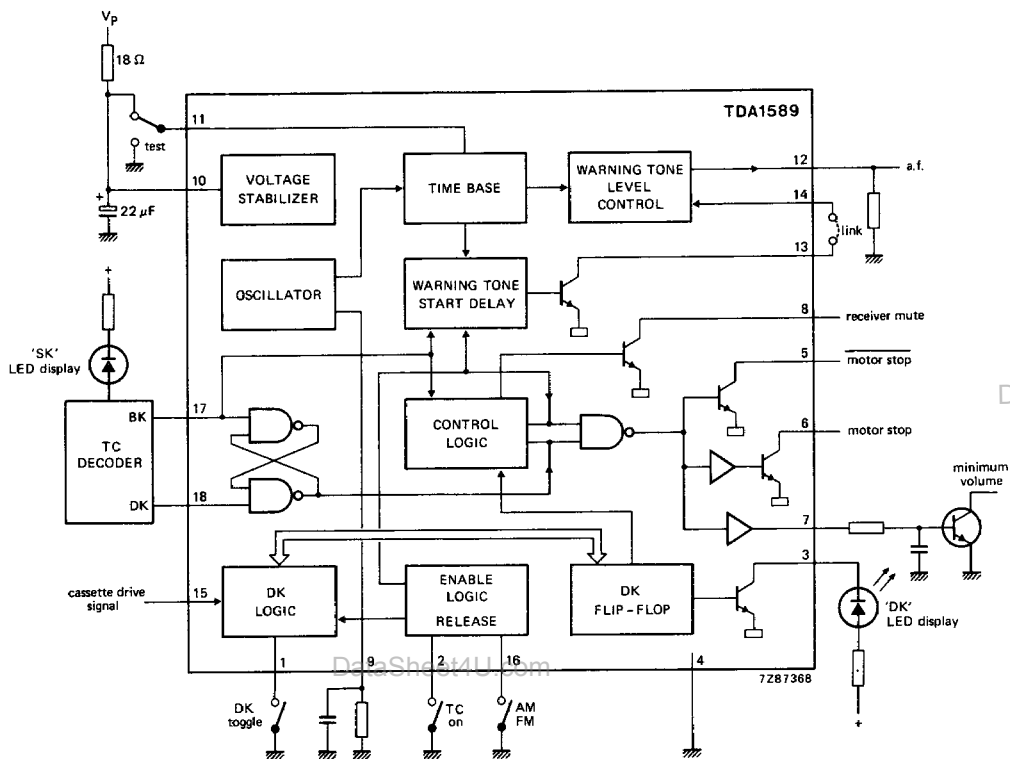
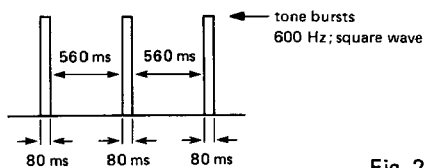
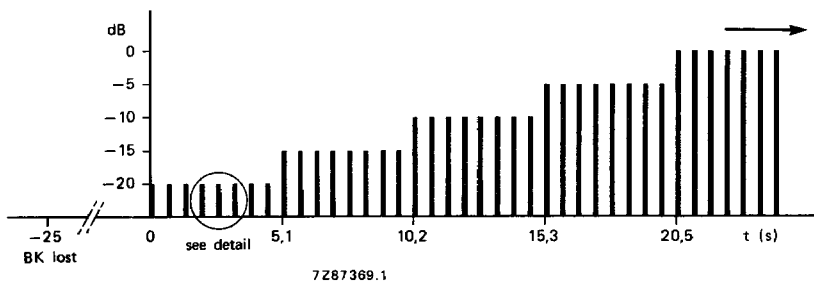

Fig. 1 Block diagram with external components; used as test circuit.

BK = TC area identification code (BereichsKennung)

DK = TC message identification code (DurchsageKennung)

SK = TC station identification code (SenderKennung)



DETAIL

Fig. 2 Intermittent step pulse warning signal.

FUNCTIONAL DESCRIPTION

The automatic evaluation of traffic control signals is only possible during FM reception. The enable circuit will be active when pin 16 (FM on) is LOW. If traffic control messages are desired, pin 2 (TC on) must be switched to LOW.

FM radio mode

By operating the DK-toggle switch at pin 1 the DK flip-flop is set. This is displayed by a LED connected to pin 3. In the position "TC off" (pin 2 HIGH) it is not possible to set the DK flip-flop. Non-traffic control stations are muted. If a message is transmitted on the tuned TC station the minimum volume at pin 7 is exposed.

In case of BK-signal failure pin 13 changes to LOW after a delay of about 25 seconds. If pins 13 and 14 are then connected, an intermittent warning signal will be supplied at pin 12. The level increases automatically from -20 dB to 0 dB in 5 steps. (See Fig. 2.)

Cassette mode

If a TC message is delivered when TC is switched on (pin 16 and pin 2 LOW) and the DK flip-flop is set, the motor of the cassette player is stopped and the receiver automatically cuts in. The minimum volume is also set at the same time.

In case of BK-signal failure, the warning tone will be mixed into the cassette playback.

Protection

To avoid faulty switching, an internal latch will be set only if both DK (pin 18) and BK (pin 17) are HIGH. The latch will be reset if DK is changed to LOW independent of BK.

Reset of the DK-toggle flip-flop:















- by operating the DK-toggle (pin 1) twice
- by opening the TC-switch (pin 2)
- by switching to AM reception (pin 16)
- by switching off the cassette-player (pin 15)
- by switching power off or on.

Transmission monitoring

At reception failure of a TC-station BK at pin 17 will become LOW. After about 25 seconds the output (pin 13) will be set LOW to start the warning signal via the jumper between pins 13 and 14. In the meantime the search-tuning can also be started. The warning tone stage gives a graduated signal with a level increasing in five steps from -20 dB to 0 dB in about 20 seconds. The frequency of the warning signal is about 600 Hz; tone period ≈ 80 ms; pause ≈ 560 ms.

If now another TC-message transmitter has been tuned the input BK (pin 17) becomes HIGH and the warning tone is stopped. Also when switching TC-off (pin 2 HIGH) or switching to AM reception (pin 16 HIGH) the warning tone will stop. The BK-signal has to be stable for more than 1 second to reset the just started 25-second-timer.

TDA1589

mode	inputs pin numbers						outputs pin numbers					
	16	2	15	1	17	18	7	5	6	8	13	3
AM RADIO	H	X	X	X	X	X	H	H	L	H	H	H
FM RADIO TC off	L	H	X	X	X	X	H	H	L	H	H	H
FM-TC on station without TC	L	L	X	X	L	X	L	L	H	L	L*	L
FM-TC on station with BK	L	L	X	H	H	L	H	H	L	H	H	H
FM-TC on station with BK, DK	L	L	X	H	H	H	L	L	H	H	H	H
FM-TC on station with BK DK-toggle operated MUTE	L	L	X		H	L	H	H	L	L	H	
FM-TC on station with BK, DK incoming message	L	L	X	H	H						H	L
FM-TC on station with BK DK-toggle operated twice	L		X		H	L	H	H	L		H	
FM-TC on and cassette station with BK, DK cassette switched on	L	L		X	H	H	L	L	H	H	H	H
FM-TC on and cassette station with BK cassette switched on	L	L		X	H	L	H	H	L	H	H	H
FM-TC on and cassette station with BK cassette switched off	L	L		X	H	L	H	H	L		H	
function and state	AM/FM HIGH/LOW	TC on on = LOW	cassette off = H → L	DK toggle active = LOW	BK on = HIGH	DK on = HIGH	min. volume on = LOW	motor stop stop = LOW	motor stop stop = HIGH	MUTE on = LOW	warning tone on = LOW	DK display on = LOW



* After about 25 seconds.

Positive logic:

H = HIGH state (the more positive voltage)

L = LOW state (the less positive voltage)

X = state is immaterial

 = positive-going transition = negative-going transition

Functions of the control inputs

DK toggle operated chatter-proof by internal delay of 10 to 20 ms	pin 1	active = LOW
TC (traffic control) released	pin 2	on = LOW
Test condition clock rate 24 times faster	pin 11	on = to ground off = to V_p or open
Start warning signal	pin 14	on = LOW
Reset of DK flip-flop by cassette player	pin 15	reset = HIGH to LOW transition
Reset of DK flip-flop by tuning AM band	pin 16	reset = HIGH
BK input*	pin 17	on = HIGH
DK input*	pin 18	on = HIGH
Minimum volume	pin 7	on = LOW
Motor stop (30 mA)	pin 5	stop = LOW
Motor stop (2 mA)	pin 6	stop = HIGH
MUTE (volume off)	pin 8	on = LOW
Warning tone	pin 13	on = LOW
DK display	pin 3	on = LOW

RATINGS

Limiting values in accordance with the Absolute Maximum System (IEC 134)

Supply voltage (pin 10)	V_p	max.	16 V
Input voltages pins 1, 2, 11, 14, 15, 16, 17 and 18	V_i		0 to V_p V
Output voltages pins 3, 5, 6, 8, 13	V_o	max.	23 V
Currents inputs 1, 2, 11, 14, 15, 16, 17 and 18	I_i	max.	10 mA
outputs 6, 8, 13	I_o	max.	10 mA
outputs 3 and 5	I_o	max.	50 mA
Storage temperature	T_{stg}		-55 to + 150 °C
Operating ambient temperature	T_{amb}		-30 to + 80 °C

* Open collector output of TC-decoder.

TDA1589

CHARACTERISTICS

V_P typ. 8,5 V; $T_{amb} = 25\text{ }^\circ\text{C}$; unless otherwise specified (see Fig. 1)

Supply voltage range

V_P 7,5 to 16 V

Supply current

I_P typ. 4,5 mA
< 6 mA

Control inputs

Pins 1, 2, 11, 14, 15, 16, 17 and 18

Input voltage HIGH

V_{IH} 3,5 V to V_P

Input voltage LOW

V_{IL} < 2 V

Input current HIGH

$V_i = 16\text{ V}$

I_{IH} < 1 μA

Input current LOW

$V_i = 0\text{ V}$

$-I_{IL}$ 25 to 200 μA

Input resistance

$V_i = 0\text{ V}$

R_i < 10 k Ω

Control outputs

DK-LED display and motor stop
open collector outputs 3 and 5

Output voltage LOW

$I_{OL} = 20\text{ mA}$

DataSheet4U.com

V_{OL} typ. 1 V
< 1,5 V

Output current LOW

I_{OL} typ. 30 mA

Output voltage HIGH (open collector)

$I_{OH} < 10\text{ }\mu\text{A}$

V_{OH} < 23 V

LF-MUTE, motor stop and warning signal start
pins 8, 6 and 13

Output voltage LOW

$I_{OL} = 1\text{ mA}$

V_{OL} < 0,35 V

Output current LOW

I_{OL} = 2 mA

Output voltage HIGH (open collector)

$I_{OH} < 1\text{ }\mu\text{A}$

V_{OH} = 16 V

Minimum voltage (pin 7) ($R_S = 800\text{ }\Omega$, $R_L = \infty$)

Output voltage LOW

(for volume HIGH)

V_{7-4} < 0,1 V

Output voltage HIGH

(for volume LOW)

V_{7-4} typ. 5 V

Warning signal (pin 12)

$f = 600\text{ Hz}$; square-wave pulsed; $R_S = 300\text{ }\Omega$

Switching time on

t_{on} typ. 80 ms

Switching time off

t_{ogf} typ. 560 ms

Output voltage during t_{on}
at maximum peak ($R_L = 1\text{ k}\Omega$)
during T_{off}

V_{12-4} typ. 4,3 V
 V_{12-4} typ. 0 V

Automatic level control

Duration per level	t_p	typ.	5 s
Output level swing (in 5 steps)	$\Delta V_{12.4}$		-20 to 0 dB
Output current peak value	$-I_{12M}$	typ.	6 mA

Oscillator (pin 9)

Frequency	f	typ.	2400 Hz
Filter resistance	R_o	typ.	100 k Ω
Filter capacitance	C_o	typ.	4,7 nF
Oscillator frequency tolerance	$\Delta f/f$		-10 to + 10 %