

T-74-05-01

DUAL BRIDGE AUDIO AMPLIFIER FOR CAR RADIO

ADVANCE DATA

- MINIMUM EXTERNAL COMPONENT COUNT
- NO BOOTSTRAP CAPACITORS
- NO BOUCHEROT CELLS
- CLIP DETECTOR OUTPUT
- HIGH OUTPUT POWER
- FIXED GAIN
- VERY LOW STAND-BY CURRENT (1µA typ)
- NO SWITCH ON/OFF NOISE

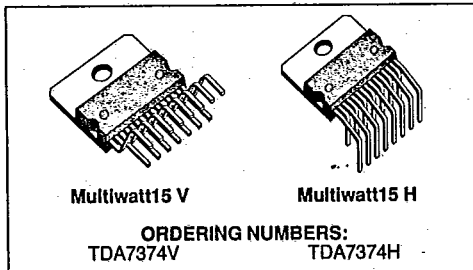

PROTECTIONS:

- OUTPUT AC/DC SHORT CIRCUIT TO GND AND TO V_s
- VERY INDUCTIVE LOADS
- OVERRATING CHIP TEMPERATURE
- LOAD DUMP VOLTAGE
- FORTUITOUS OPEN GND
- REVERSE BATTERY
- ESD

DESCRIPTION

The TDA7374 is a new technology class AB Audio Dual Bridge Power Amplifier in Multiwatt package designed for car radio applications.

Thanks to the fully complementary PNP/NPN output configuration the high power performances of the TDA7374 are obtained without the bootstrap capacitors.

TEST AND APPLICATION CIRCUIT

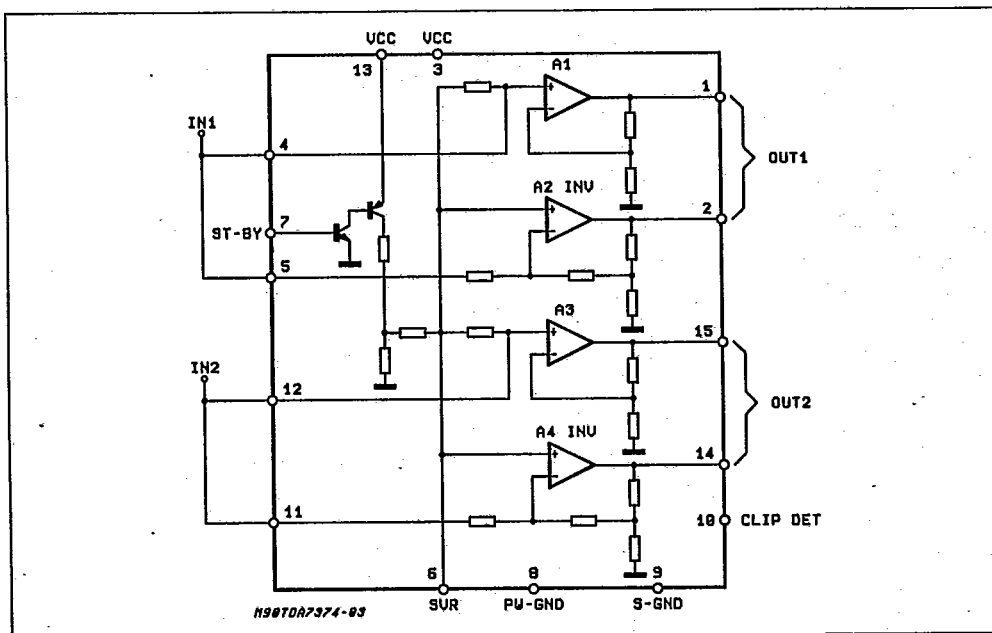

May 1991

1/11

This is advanced information on a new product now in development or undergoing evaluation. Details are subject to change without notice, notice.

897

PIN CONNECTION (Top view)

SGS-THOMSON

T-74-05-01

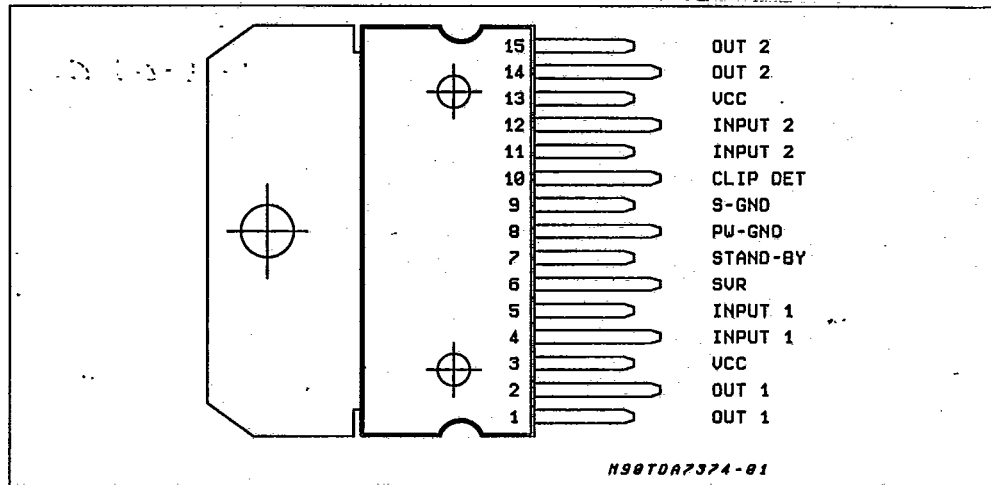

ABSOLUTE MAXIMUM RATINGS

Symbol	Parameter	Value	Unit
V_s	DC Supply Voltage	28	V
V_{OP}	Operating Supply Voltage	18	V
V_{PEAK}	Peak Supply Voltage ($t = 50ms$)	50	V
I_o	Output Peak Current (not rep. $t = 100\mu s$)	4.5	A
I_o	Output Peak Current (rep. $f > 10Hz$)	3.5	A
P_{tot}	Power Dissipation $T_{CASE} = 85^\circ C$	36	W
T_{stg}, T_j	Storage and Junction Temperature	-40 to 150	$^\circ C$

THERMAL DATA

Symbol	Description	Value	Unit
$R_{th j-case}$	Thermal Resistance Junction-case	Max 1.8	$^\circ C/W$

ELECTRICAL CHARACTERISTICS (Refer to the test circuit; $V_S = 14.4V$; $R_L = 4\Omega$, $T_{amb} = 25^\circ C$, $f = 1kHz$, unless otherwise specified)

Symbol	Parameter	Test Condition	Min.	Typ.	Max.	Unit
V_S	Supply Range		8		18	V
I_d	Total Quiescent Drain Current	$R_L = \infty$			150	mA
P_O	Output Power	$R_L = 4\Omega$; THD = 10%	17	21		W
d	Distortion	$R_L = 4\Omega$ $P_O = 0.1$ to 10W			0.5	%
CT	Cross-Talk	$f = 1kHz$ $f = 10kHz$		65 55		dB dB
R_{IN}	Input Impedance		10			K Ω
G_V	Voltage Gain			26		dB
G_V	Voltage Gain Match.				1	dB
E_{IN}	Input Noise Voltage	$R_S = 0$ to 10k Ω Weight A 22Hz to 22KHz		3.5	10	μV μV
SVR	Supply Voltage Rejection	$R_S = 0$; $f = 100Hz$ $f = 10kHz$	48	55		dB
ASB	Stand-by Attenuation		60			dB
I_{SB}	ST-BY Current			1		μA
$V_{SB ON}$	ST-BY On Threshold Voltage				1.5	V
$V_{SB OFF}$	ST-BY Off Threshold Voltage		3.5			V
V_{OS}	Output Offset Voltage				200	mV
$I_{CD OFF}$	Clipping Detector "OFF" Output Average Current	THD = 1% (*)		100		μA
$I_{CD ON}$	Clipping Detector "ON" Output Average Current	THD = 10% (*)		190		μA

(*) Pin 10 Pulled-up to 5V with 10k Ω ; $R_L = 4\Omega$

SGS-THOMSON

TEST AND APPLICATION CIRCUIT

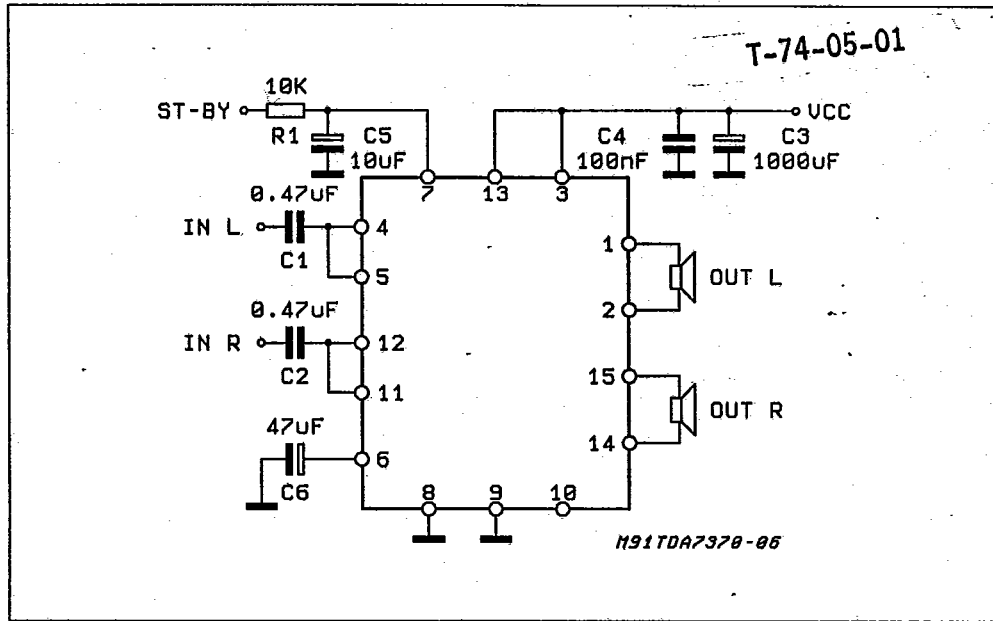

P.C. BOARD AND COMPONENT LAYOUT (1:1 scale)

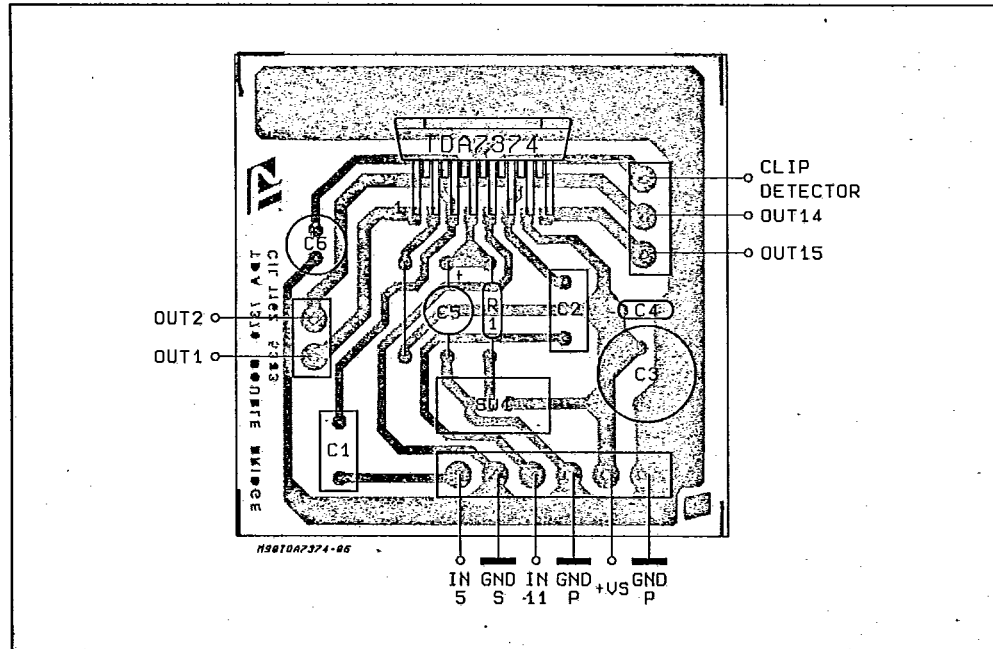

Figure 1: Quiescent Drain Current vs. Supply Voltage

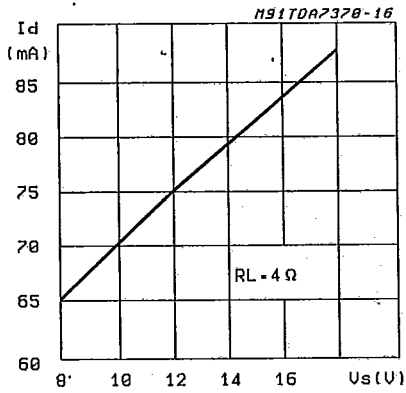

Figure 2: Quiescent Output Voltage vs. Supply Voltage

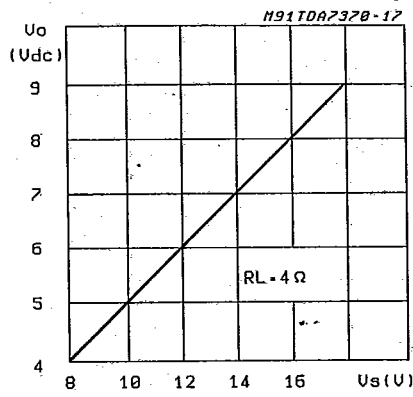

Figure 3: Output Power vs. Supply Voltage

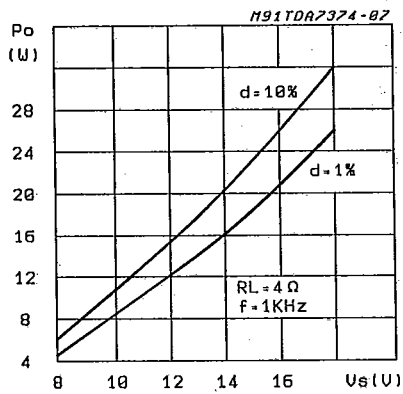

Figure 4: Distortion vs. Output Power

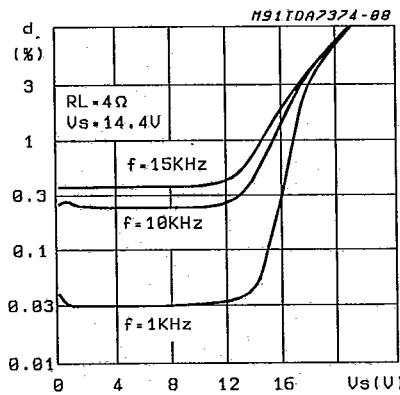

Figure 5: Output Power vs. Frequency

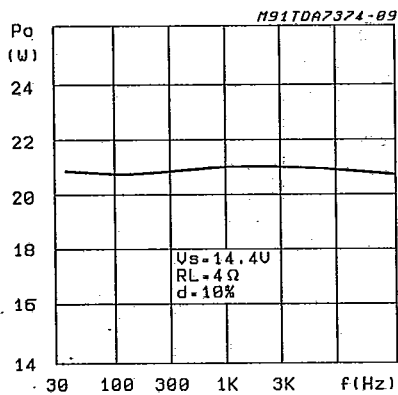

Figure 6: Supply Voltage Rejection vs. Frequency for a Different values of C6 Capacitor

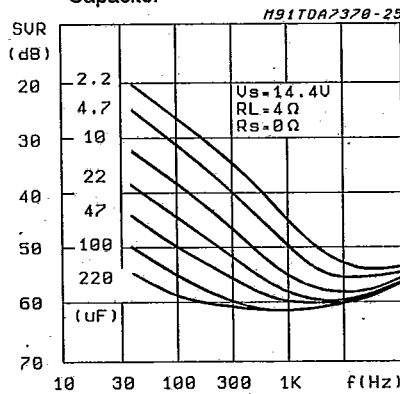

Figure 7: Cross-Talk vs. Frequency

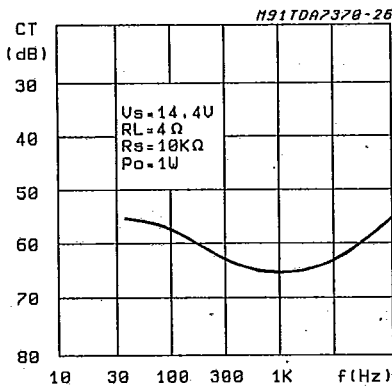

Figure 8: En Input vs. Rg

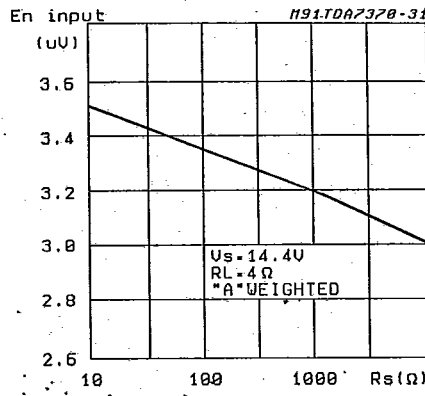

Figure 9: Stand-by Attenuation vs. Threshold Voltage

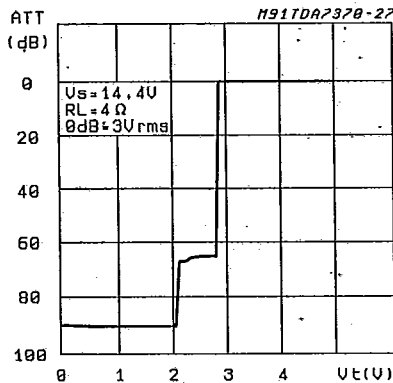

Figure 10: Stand-by Attenuation vs. Input Voltage

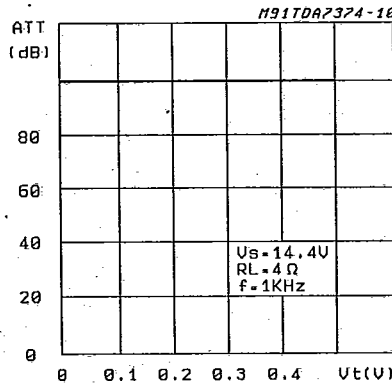

Figure 11: Clipping Detector Average Current (Pin 10) vs. Distortion

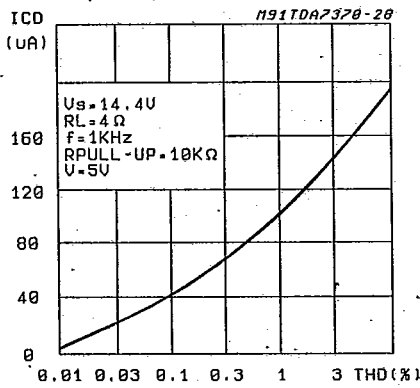
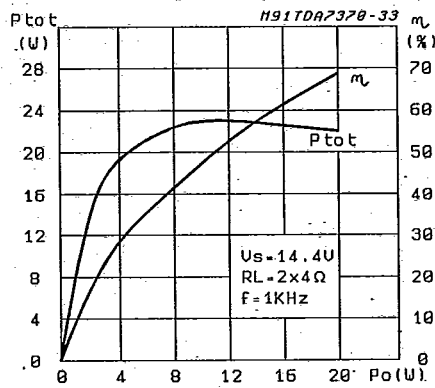

Figure 12: Total Power Dissipation and Efficiency vs. Output Power



OUTPUT STAGE

The fully complementary output stage was made possible by the development of a new component: the ST exclusive power ICV PNP.

A novel design based upon the connection shown in fig. 13 has then allowed the full exploitation of its possibilities.

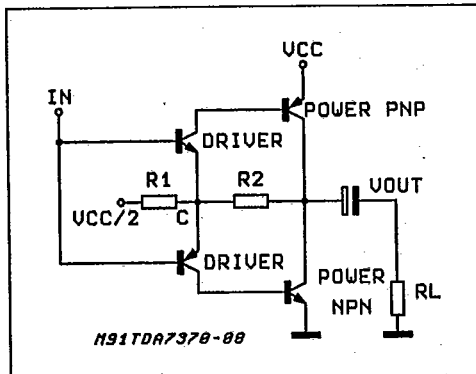
Figure 13: The new Output Stage

The clear advantages this new approach has over classical output stages are as follows:

1 - Rail-to-Rail Output Voltage Swing With No Need Of Bootstrap Capacitors.

The output swing is limited only by the V_{cesat} of the output transistors, which are in the range of 0.6 Ohm each.

Classical solutions adopting composite PNP-NPN for the upper output stage have higher saturation

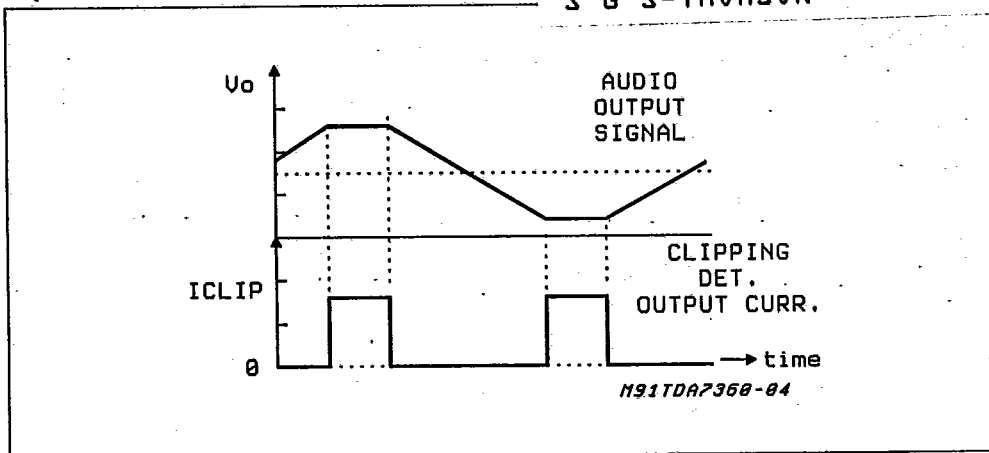
Figure 14: Clipping Detection Waveforms

S G S-THOMSON

SGS-THOMSON
MICROELECTRONICS

7/11

903

loss on the top side of the waveform. This unbalanced saturation causes a significant power reduction. The only way to recover power consists of the addition of expensive bootstrap capacitors.

2 - Absolute Stability Without Any External Compensation.

Referring to the circuit of Fig. 13 the gain V_{OUT}/V_{IN} is greater than unity, approximately $1 + R2/R1$. The DC Output ($V_{CC}/2$) is fixed by an auxiliary amplifier common to all the channels).

By controlling the amount of this local feedback it is possible to force the loop gain ($A * \beta$) to less than unity at frequency for which the phase shift is 180 Deg. This means that the output buffer is intrinsically stable and not prone to oscillation.

Most remarkably, the above feature has been achieved in spite of the very low closed loop gain of the amplifier.

In contrast, with the classical PNP-NPN stage, the solution adopted for reducing the gain at high frequencies makes use of external RC networks, namely the Boucherot cells.

T-74-05-01

OTHER OUTSTANDING CHARACTERISTICS:**Clipping Detector Output**

The TDA7374 is equipped with an internal circuit able to detect the output stage saturation providing a proper current sinking into an open collector output (pin 10) when a certain distortion level is reached at each output.

This particular function allows gain compression facility whenever the amplifier is overdriven, thus obtaining high quality sound at all listening levels.

Offset Control

The quiescent output voltage must be as close as possible to its nominal value, so that less undistorted power would be available.

For this reason an input bias current compensation is implemented to reduce the voltage drop across the input resistors, which appears amplified at the outputs.

Gain Internally Fixed to 26dB

Advantages of this design choice are in terms of:

- components and space saving
- output noise, supply voltage rejection and distortion optimization.

Silent Turn On/Off and Muting/Stand-by Function

The stand-by can be easily activated by means of a CMOS level applied to pin 7 through a RC filter. Under stand-by condition the device is turned off completely (supply current = 1 μ A TYP; output attenuation = 90 dB TYP).

Every ON/OFF operation is virtually pop free.

Furthermore, at turn-on the device stays in muting condition for a time determined by the value assigned to the SVR capacitor ($T = C_{svr} * 7,000$). While in muting the device outputs becomes insensitive to any kinds of signal that may be present at the input terminals. In other words every transient coming from previous stages produces no unpleasant acoustic effect to the speakers.

Another situation under which the device is totally muted is whenever the supply voltage drops lower than 7V. This is helpful to pop suppression during the turn-off by battery switch.

BUILT-IN PROTECTION SYSTEMS**Full Protection of Device and Loudspeakers Against AC/DC Short Circuits (to Gnd, to V_s , across the Speakers).**

Reliable and safe operation in presence of all kinds of short circuit involving the outputs is assured by a built-in protection system that operates in the following way:

In case of overload, a SCR is activated as soon as the current flowing through the output transistors overcomes a preset threshold value depending on the chip temperature. The SCR causes an interruption of the supply current of the power transistor. The normal working is restored by a restart circuit going into action as soon as the short circuit is removed.

Load Dump Voltage Surge

The TDA 7374 has a circuit which enables it to withstand a voltage pulse train on pins 3 and 13,

of the type shown in fig. 16.

If the supply voltage peaks to more than 50V, then an LC filter must be inserted between the supply and pins 3 and 13, in order to assure that the pulses at pins 3 and 13 will be held within the limits shown.

A suggested LC network is shown in fig. 15.

With this network, a train of pulses with amplitude up to 120V and width of 2ms can be applied at point A. This type of protection is ON when the supply voltage (pulse or DC) exceeds 18V. For this reason the maximum operating supply voltage is 18V.

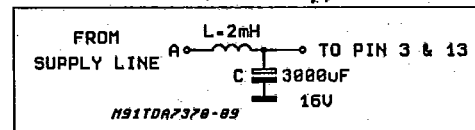
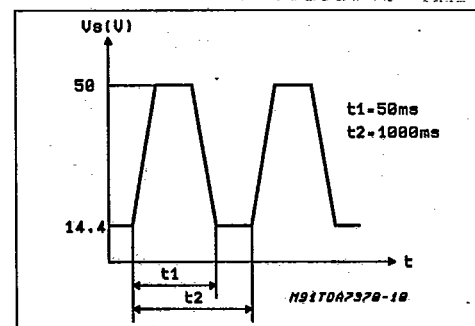
Figure 15**Figure 16****S G S-THOMSON****Polarity Inversion**

High current (up to 10A) can be handled by the device with no damage for a longer period than the blow-out time of a quick 2A fuse (normally connected in series with the supply). This feature is added to avoid destruction, if during fitting to the car, a mistake on the connection of the supply is made.

Open Ground

When the radio is in the ON condition and the ground is accidentally opened, a standard audio amplifier will be damaged. On the TDA7374 protection diodes are included to avoid any damage.

Inductive Load

A protection diode is provided to allow use of the TDA7374 with inductive loads.

DC Voltage

The maximum operating DC voltage for the TDA7374 is 18V. However the device can withstand a DC voltage up to 28V with no damage. This could occur during winter if two batteries are series connected to crank the engine.

Thermal Shut-down

The presence of a thermal limiting circuit offers the following advantages:

1) an overload on the output (even if it is permanent), or an excessive ambient temperature can be easily withstood.

2) the heatsink can have a smaller factor of safety compared with that of a conventional circuit. There is no device damage in case of excessive junction temperature: all happens is that P_o (and therefore P_{tot}) and I_d are reduced.

The maximum allowable power dissipation depends upon the size of the external heatsink (i.e. its thermal resistance); Fig. 17 shows the dissippable power as a function of ambient temperature for different thermal resistance.

Figure 17: Maximum Allowable Power Dissipation vs. Ambient Temperature

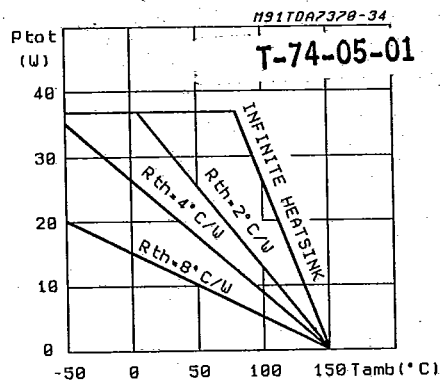
**Loudspeaker Protection**

The TDA7374 guarantees safe operations even for the loudspeaker in case of accidental shortcircuit.

Whenever a single OUT to GND, OUT to V_S short circuit occurs both the outputs are switched OFF so limiting dangerous DC current flowing through the loudspeaker.

SGS-THOMSON

CLIPPING DETECTOR

Fig 19 shows an application using the TDA7374 in combination with the SGS-THOMSON audio-processor TDA7302.

The output clipping is recognized by the microprocessor (in this application it is simulated by a PC).

The detailed way to operate of the system is represented by the flow-chart of fig.18.

The controller detects when the clipping is active (minimum detection width fixed by a $C29 = 12 \text{ nF}$ external capacitor), and reduces the volume (or bass) by step of 2 dB (with a programmable waiting time), until no more clipping is detected.

Then the controller waits for a programmable time before increasing the volume again by step of 2 dB until clipping is again detected or the panel selected volume is reached.

Practical advantages of this application is a better sound quality deriving from operation under no clipping conditions, which also means the availability of higher undistorted power.

Figure: 18: Clipping Detector Control Routine

WHAT IS NEEDED FOR A DEMONSTRATION

- a XT or AT IBM compatible PC, supplied with EGA card
- a SGS-THOMSON audioprocessor application disk
- a TDA 7302 + TDA7374 board
- a connector from audioprocessor board to PC parallel port

SGS-THOMSON**GENERAL INFORMATION**

In the application shown in fig 18 the TDA7302 audioprocessor works on PC XT or AT IBM compatible.

Control is accomplished by serial bus (S-bus or I²C-bus or SPI bus) sent to the test board through the PC parallel port.

The PC simulates the behaviour of the microprocessor in a real application (for example in a car radio) and the buffer is necessary only in this application for protecting the PC.

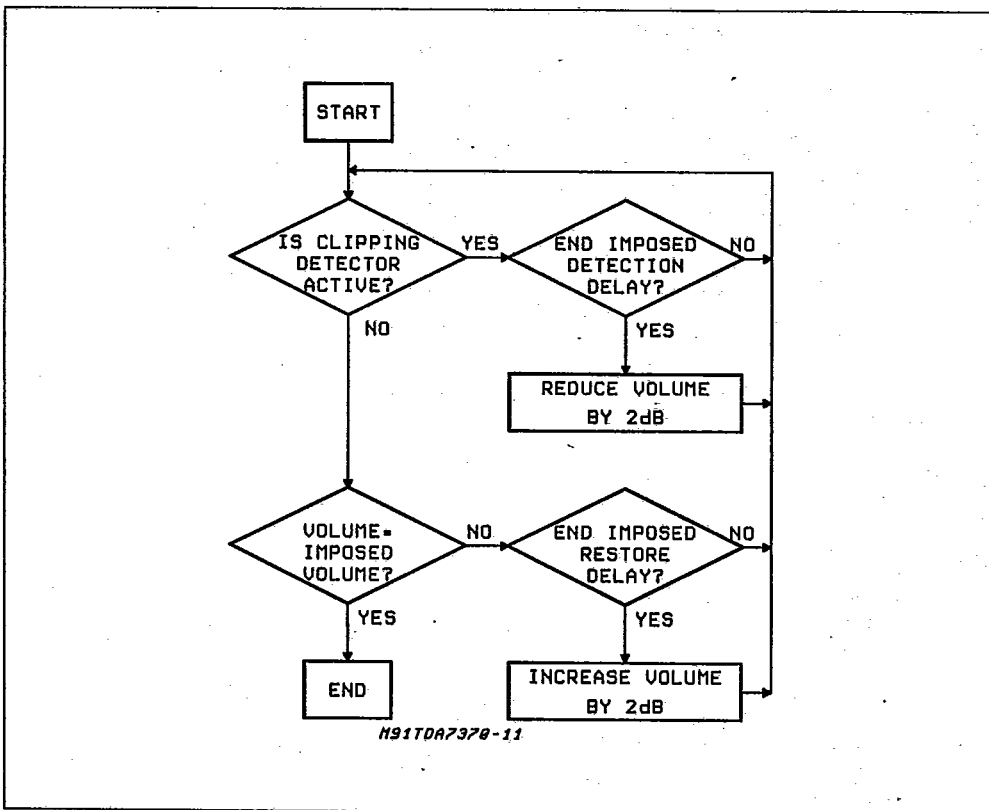
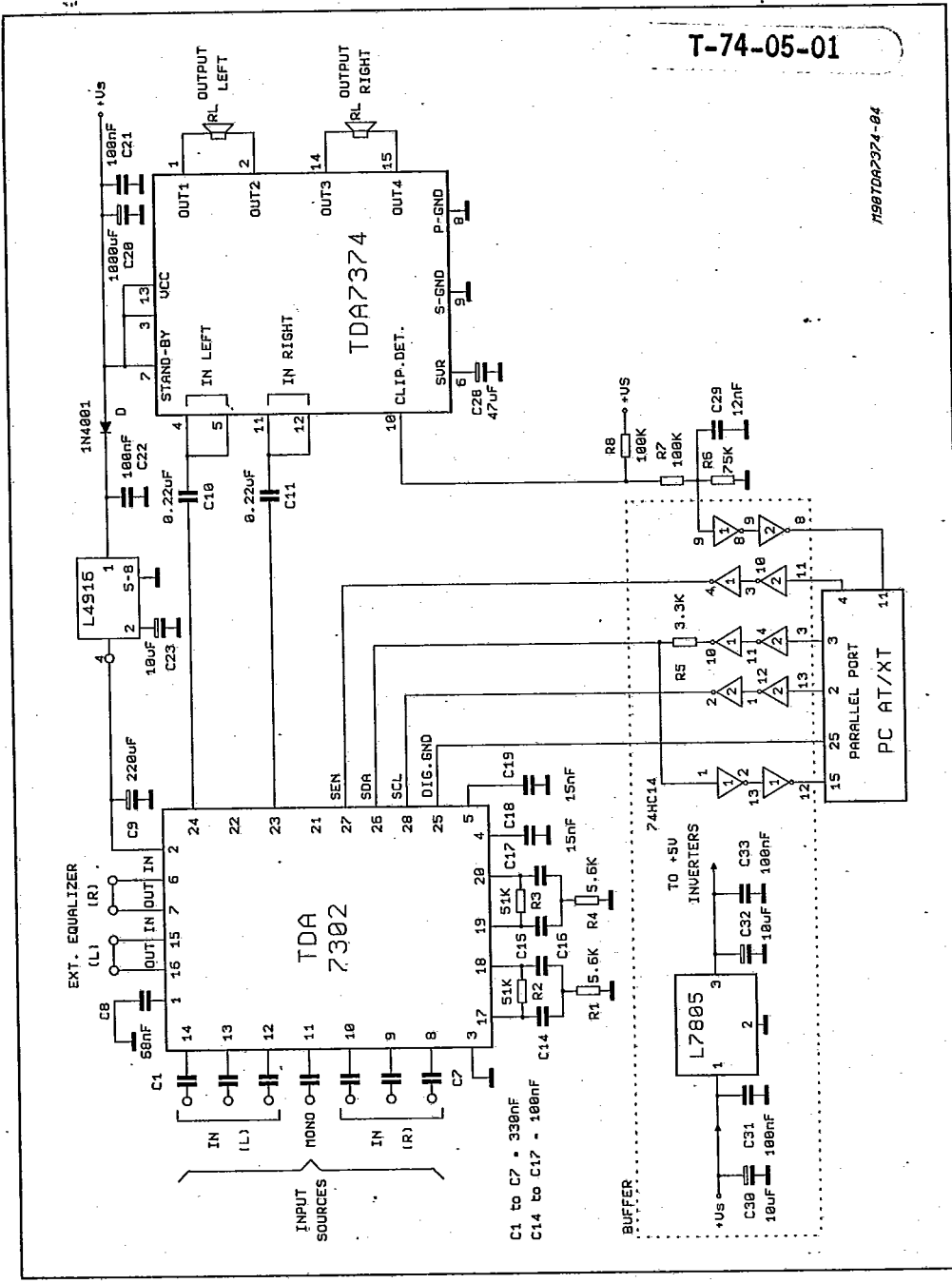

Figure 19: Application with TDA7302 + TDA7374

S G S-THOMSON



T-74-05-01

1987092374-04