



TDA7564B

4 x 50W multifunction quad power amplifier
with built-in diagnostics features

Features

- Multipower BCD technology
- MOSFET output power stage
- DMOS power output
- New Hi-efficiency (class SB)
- High output power capability 4x28W/4Ω @ 14.4V, 1KHZ, 10% THD, 4x50W max, power
- Max. output power 4x72W/2Ω
- Full I²C bus driving:
 - St-by
 - Independent front/rear soft play/mute
 - Selectable gain (for low noise line output function)
 - High efficiency enable/disable
 - I²C bus digital diagnostics (including AC and DC load detection)
- Full fault protection
- DC offset detection
- Four independent short circuit protection
- Clipping detector (2%/10%)
- Linear thermal shutdown with multiple thermal warning
- ESD protection

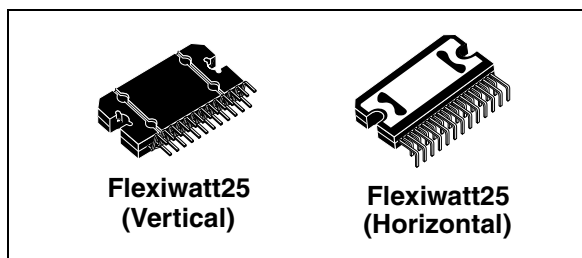

Description

The TDA7564B is a new BCD technology QUAD BRIDGE type of car radio amplifier in Flexiwatt25 package specially intended for car radio applications.

Thanks to the DMOS output stage the TDA7564B has a very low distortion allowing a clear powerful sound. Among the features, its superior efficiency performance coming from the internal exclusive structure, makes it the most suitable device to simplify the thermal management in high power sets.

The dissipated output power under average listening condition is in fact reduced up to 50% when compared to the level provided by conventional class AB solutions. This device is equipped with a full diagnostics array that communicates the status of each speaker through the I²C bus.

Order codes

Part number	Package	Packing
TDA7564B	Flexiwatt25 (vertical)	Tube
TDA7564BH	Flexiwatt25 (horizontal)	Tube

Contents

1	Block diagrams and application circuit	4
2	Pins description	5
3	Electrical specifications	6
3.1	Absolute maximum ratings	6
3.2	Thermal data	6
3.3	Electrical characteristics	6
3.4	Electrical characteristics curves	9
4	Diagnostics functional description	12
4.1	Turn-on diagnostic	12
4.2	Permanent diagnostics	14
4.3	Output DC offset detection	15
4.4	AC diagnostic	15
5	Multiple faults	17
5.1	Faults availability	17
6	Thermal protection	18
6.1	I2C programming/reading sequences	18
7	Fast muting	19
8	I²C Bus interface	20
8.0.1	Data Validity	20
8.0.2	Start and Stop Conditions	20
8.0.3	Byte Format	20
8.0.4	Acknowledge	20
9	Software specifications	22
10	Examples of bytes sequence	26

11	Package information	27
12	Revision history	29

1 Block diagrams and application circuit

Figure 1. Block diagram

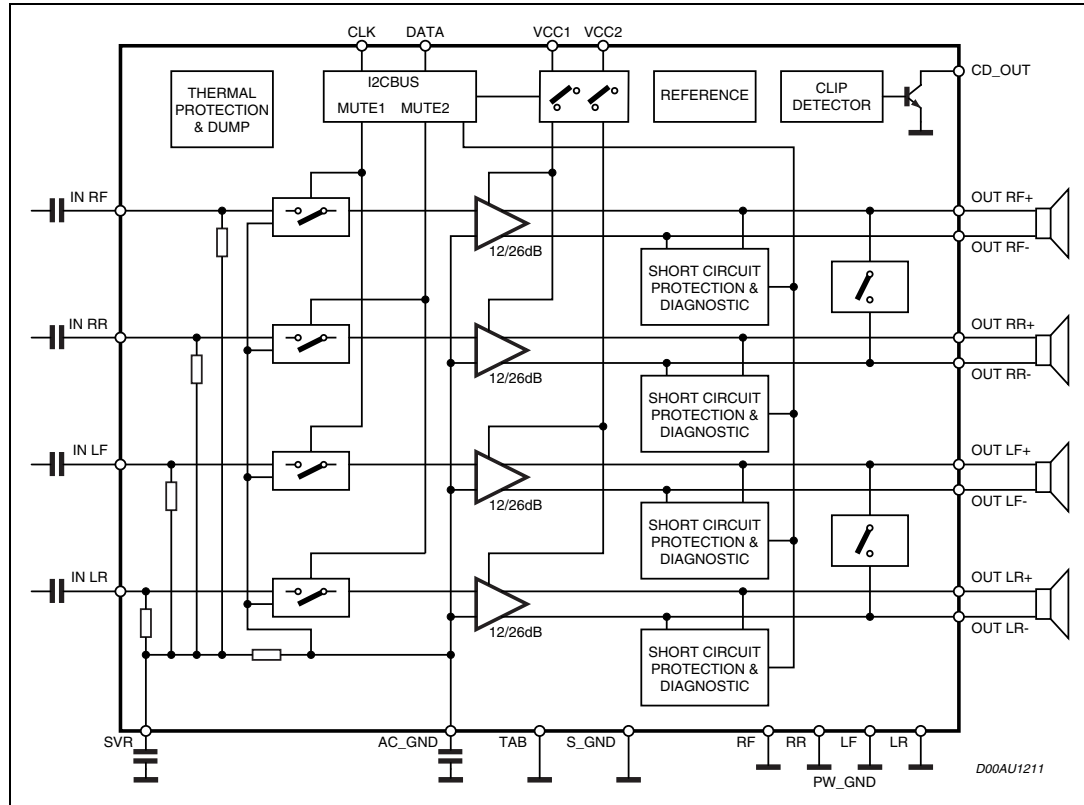
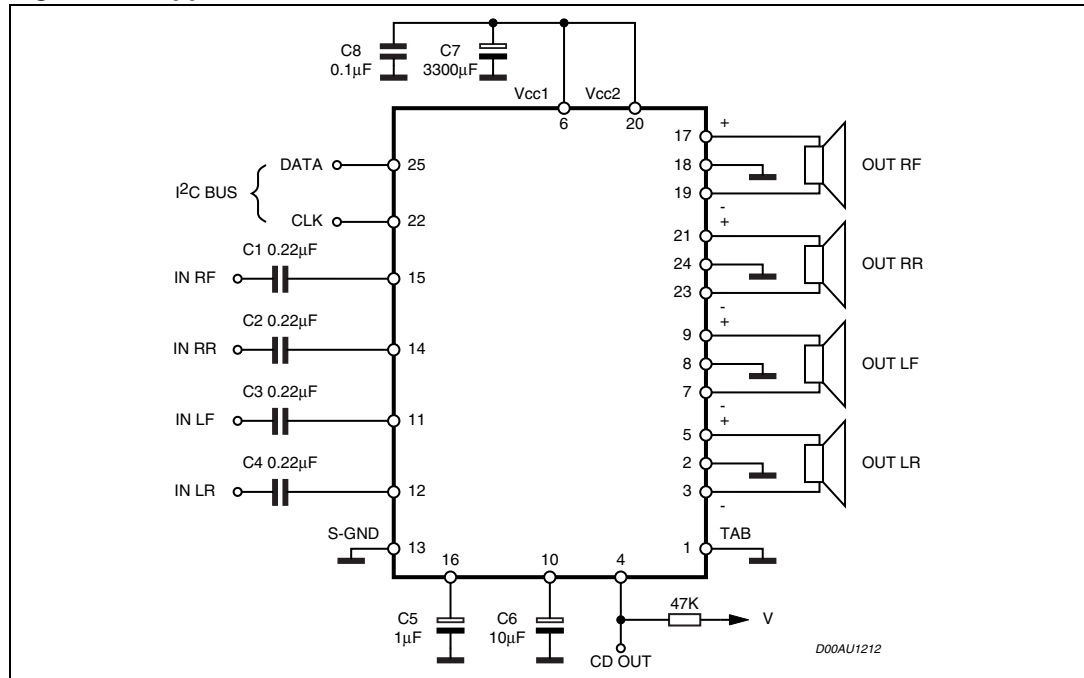

Figure 2. Application circuit



2 Pins description

Figure 3. Flexiwatt25 vertical pins connection diagram (Top of view)

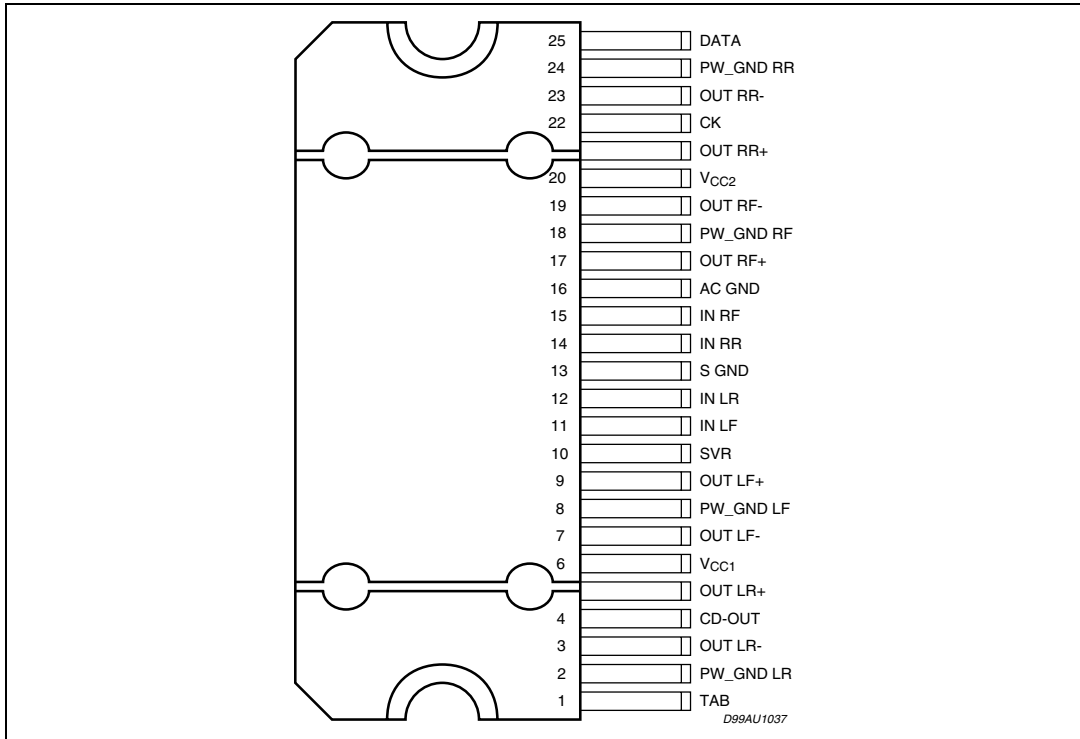
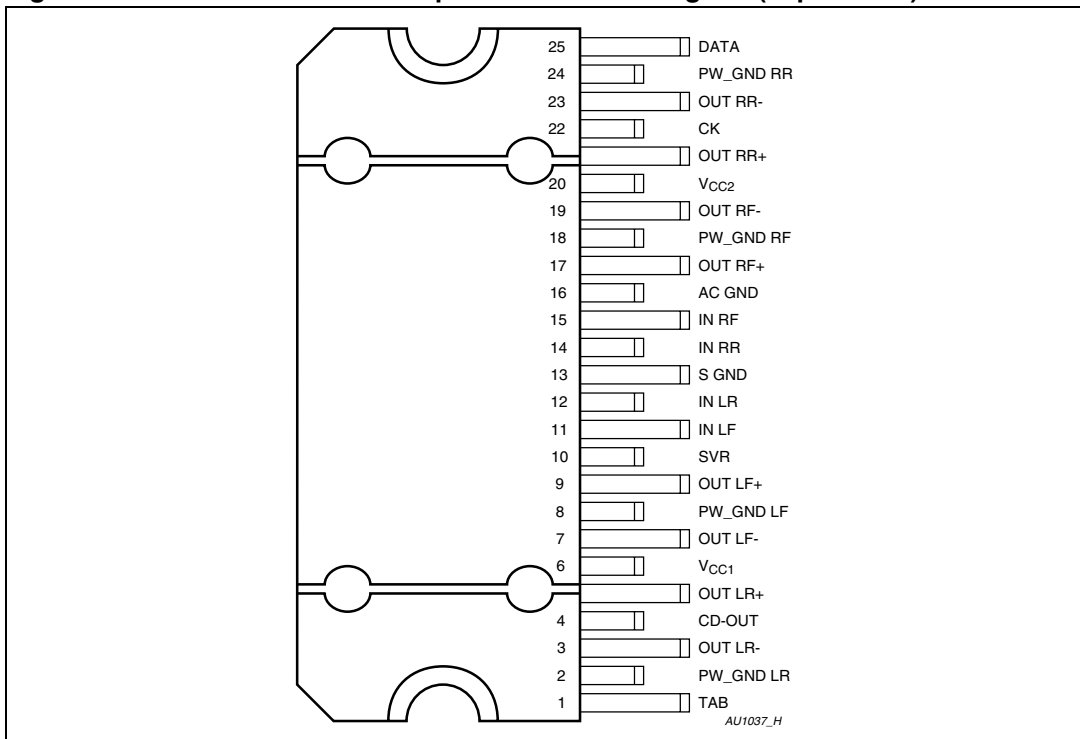

Figure 4. Flexiwatt25 horizontal pins connection diagram (Top of view)



3 Electrical specifications

3.1 Absolute maximum ratings

Table 1. Absolute Maximum Ratings

Symbol	Parameter	Value	Unit
V_{op}	Operating Supply Voltage	18	V
V_S	DC Supply Voltage	28	V
V_{peak}	Peak Supply Voltage (for $t = 50ms$)	50	V
V_{CK}	CK pin Voltage	6	V
V_{DATA}	Data Pin Voltage	6	V
I_O	Output Peak Current (not repetitive $t = 100ms$)	8	A
I_O	Output Peak Current (repetitive $f > 10Hz$)	6	A
P_{tot}	Power Dissipation $T_{case} = 70^{\circ}C$	85	W
T_{stg}, T_j	Storage and Junction Temperature	-55 to 150	$^{\circ}C$

3.2 Thermal data

Table 2. Thermal Data

Symbol	Parameter	Value	Unit
$R_{th\ j-case}$	Thermal Resistance Junction to case Max.	1	$^{\circ}C/W$

3.3 Electrical characteristics

Refer to the test circuit, $V_S = 14.4V$; $R_L = 4\Omega$; $f = 1KHz$; $G_V = 30dB$; $T_{amb} = 25^{\circ}C$; unless otherwise specified.

Table 3. Electrical Characteristics

Symbol	Parameter	Test Condition	Min.	Typ.	Max.	Unit
POWER AMPLIFIER						
V_S	Supply Voltage Range		8		18	V
I_d	Total Quiescent Drain Current			170	300	mA
P_O	Output Power	Max. power ($V_S = 15.2V$, square wave input (2Vrms))		50		W
		THD = 10%	25	28		W
		THD = 1%	20	22		W

Table 3. Electrical Characteristics (continued)

Symbol	Parameter	Test Condition	Min.	Typ.	Max.	Unit
P _O	Output Power	R _L = 2Ω; EIAJ (V _S = 13.7V)	55	68		W
		R _L = 2Ω; THD 10%	40	50		W
		R _L = 2Ω; THD 1%	32	40		W
		R _L = 2Ω; MAX POWER	60	75		W
THD	Total Harmonic Distortion	P _O = 1W to 10W; STD MODE		0.02	0.1	%
		HE MODE; P _O = 1.5W		0.015	0.1	%
		HE MODE; P _O = 8W		0.15	0.5	%
		G _V = 12dB; STD Mode		0.02	0.05	%
		V _O = 0.1 to 5VRMS				%
C _T	Cross Talk	f = 1KHz to 10KHz, R _g = 600Ω	50	60		dB
R _{IN}	Input Impedance		60	100	130	KΩ
G _{V1}	Voltage Gain 1		25	26	27	dB
ΔG _{V1}	Voltage Gain Match 1		-1		1	dB
G _{V2}	Voltage Gain 2		11	12	13	dB
ΔG _{V2}	Voltage Gain Match 2		-1		1	dB
E _{IN1}	Output Noise Voltage 1	R _g = 600Ω 20Hz to 22kHz		35	100	μV
E _{IN2}	Output Noise Voltage 2	R _g = 600Ω; G _V = 12dB 20Hz to 22kHz		12	30	μV
SVR	Supply Voltage Rejection	f = 100Hz to 10kHz; V _r = 1Vpk; R _g = 600Ω	50	60		dB
BW	Power Bandwidth		100			KHz
A _{SB}	Stand-by Attenuation		90	110		dB
I _{SB}	Stand-by Current	V _{st-by} = 0		25	50	μA
A _M	Mute Attenuation		80	100		dB
V _{OS}	Offset Voltage	Mute & Play	-100	0	100	mV
V _{AM}	Min. Supply Mute Threshold		7	7.5	8	V
CMRR	Input CMRR	V _{CM} = 1Vpk-pk; R _g = 0 Ω		55		dB
T _{ON}	Turn ON Delay	D2/D1 (IB1) 0 to 1		20	40	ms
T _{OFF}	Turn OFF Delay	D2/D1 (IB1) 1 to 0		20	40	ms
CD _{LK}	Clip Det High Leakage Current	CD off		0	5	μA
CD _{SAT}	Clip Det Sat. Voltage	CD on; I _{CD} = 1mA		150	300	mV
CD _{THD}	Clip Det THD level	D0 (IB1) = 1	5	10	15	%
		D0 (IB1) = 0	1	2	3	%

Table 3. Electrical Characteristics (continued)

Symbol	Parameter	Test Condition	Min.	Typ.	Max.	Unit
TURN ON DIAGNOSTICS 1 (Power Amplifier Mode)						
Pgnd	Short to GND det. (below this limit, the Output is considered in Short Circuit to GND)	Power Amplifier in st-by			1.2	V
Pvs	Short to Vs det. (above this limit, the Output is considered in Short Circuit to Vs)		Vs -1.2			V
Pnop	Normal operation thresholds. (Within these limits, the Output is considered without faults).		1.8		Vs -1.8	V
Lsc	Shorted Load det.				0.5	Ω
Lop	Open Load det.		85			Ω
Lnop	Normal Load det.		1.75		45	Ω
TURN ON DIAGNOSTICS 2 (Line Driver Mode)						
Pgnd	Short to GND det. (below this limit, the Output is considered in Short Circuit to GND)	Power Amplifier in st-by			1.2	V
Pvs	Short to Vs det. (above this limit, the Output is considered in Short Circuit to VS)		Vs -1.2			V
Pnop	Normal operation thresholds. (Within these limits, the Output is considered without faults).		1.8		Vs -1.8	V
Lsc	Shorted Load det.				2	Ω
Lop	Open Load det.		330			Ω
Lnop	Normal Load det.		7		180	Ω
PERMANENT DIAGNOSTICS 2 (Power Amplifier Mode or Line Driver Mode)						
Pgnd	Short to GND det. (below this limit, the Output is considered in Short Circuit to GND)	Power Amplifier in Mute or Play, one or more short circuits protection activated			1.2	V
Pvs	Short to Vs det. (above this limit, the Output is considered in Short Circuit to VS)		Vs -1.2			V
Pnop	Normal operation thresholds. (Within these limits, the Output is considered without faults).		1.8		Vs -1.8	V
L _{SC}	Shorted Load Det.	Pow. Amp. mode			0.5	Ω
		Line Driver mode			2	Ω
V _O	Offset Detection	Power Amplifier in play, AC Input signals = 0	± 1.5	± 2	± 2.5	V

Table 3. Electrical Characteristics (continued)

Symbol	Parameter	Test Condition	Min.	Typ.	Max.	Unit
I_{NLH}	Normal load current detection	$V_O < (V_S - 5)\mu\text{k IB2 (D7) = 0}$	500			mA
I_{NLL}	Normal load current detection	$V_O < (V_S - 5)\mu\text{k IB2 (D7) = 1}$	250			mA
I_{OLH}	Open load current detection	$V_O < (V_S - 5)\mu\text{k IB2 (D7) = 0}$			250	mA
I_{OLL}	Open load current detection	$V_O < (V_S - 5)\mu\text{k IB2 (D7) = 1}$			125	mA
I²C BUS INTERFACE						
S_{CL}	Clock Frequency				400	KHz
V_{IL}	Input Low Voltage				1.5	V
V_{IH}	Input High Voltage		2.3			V

3.4 Electrical characteristics curves

Figure 5. Quiescent Current vs. Supply Voltage

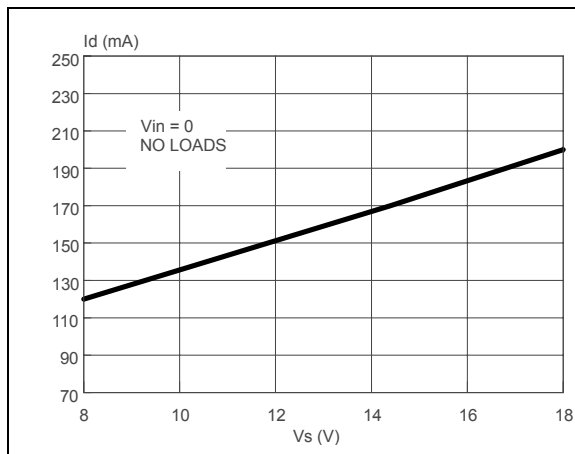

Figure 6. Output Power vs. Supply Voltage (4Ω)

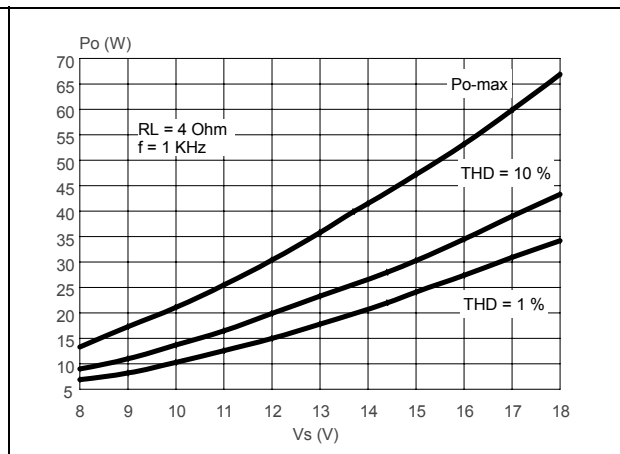

Figure 7. Output Power vs. Supply Voltage (2Ω)

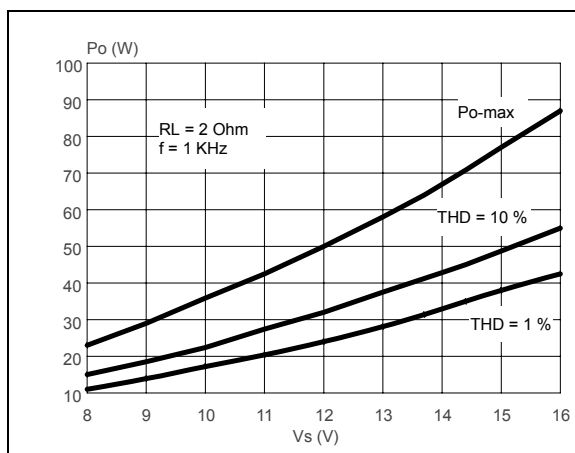

Figure 8. Distortion vs. Output Power (4Ω, STD)

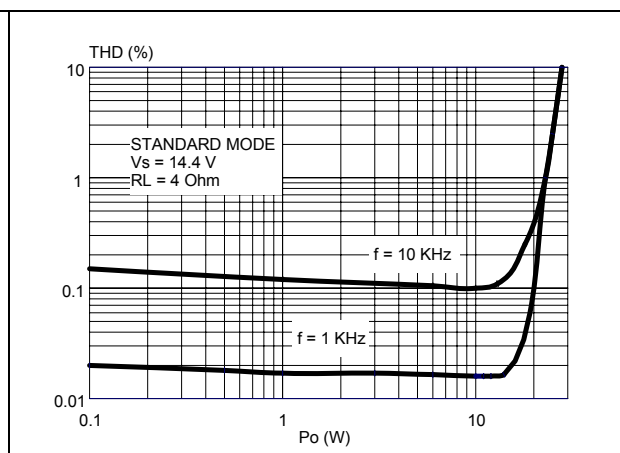

Figure 9. Distortion vs. Output Power (4Ω, HI-EFF)

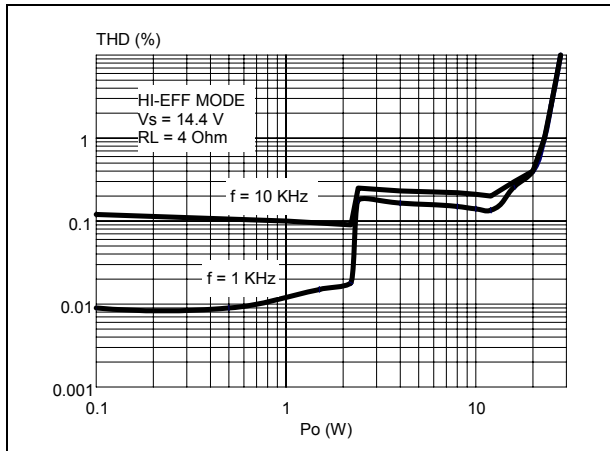

Figure 10. Distortion vs. Output Power (2Ω, STD)

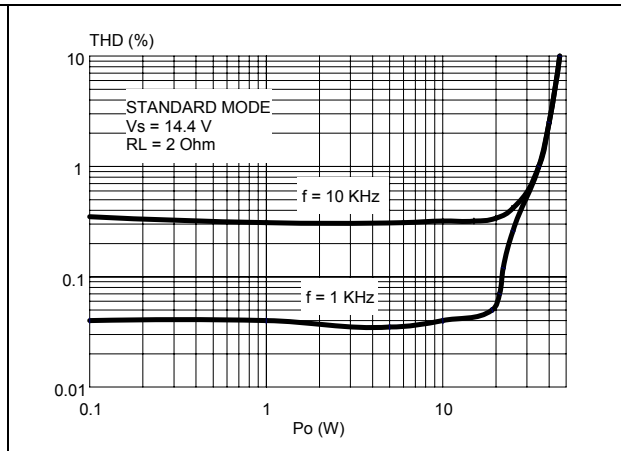

Figure 11. Distortion vs. Frequency (4Ω)

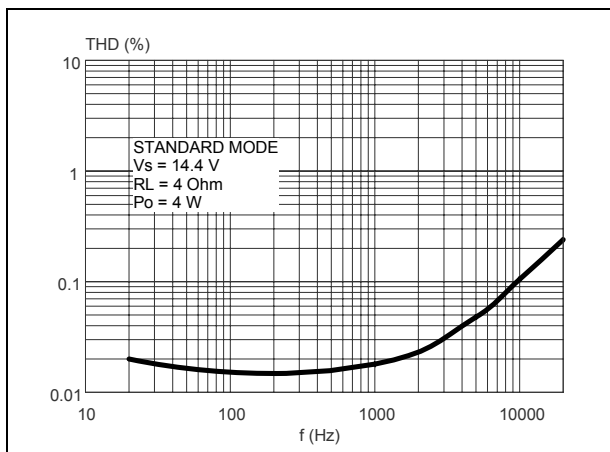

Figure 12. Distortion vs. Frequency (2Ω)

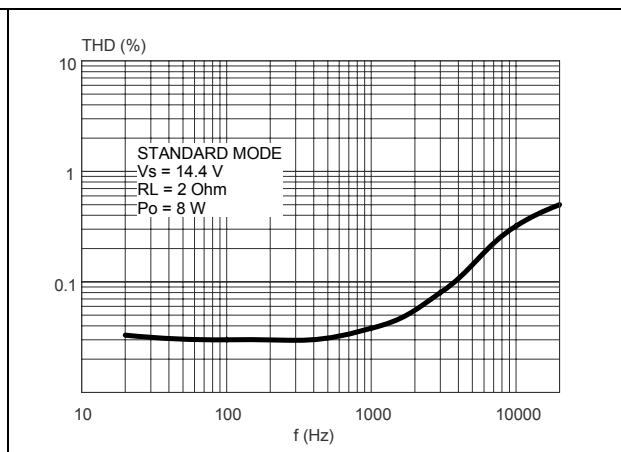

Figure 13. Crosstalk vs. Frequency

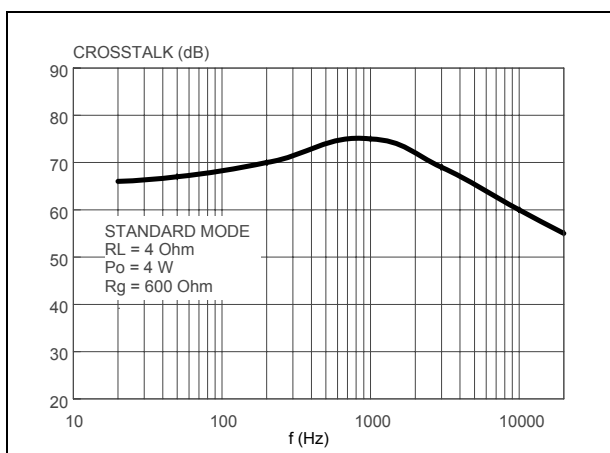

Figure 14. Supply Voltage Rejection vs. Freq.

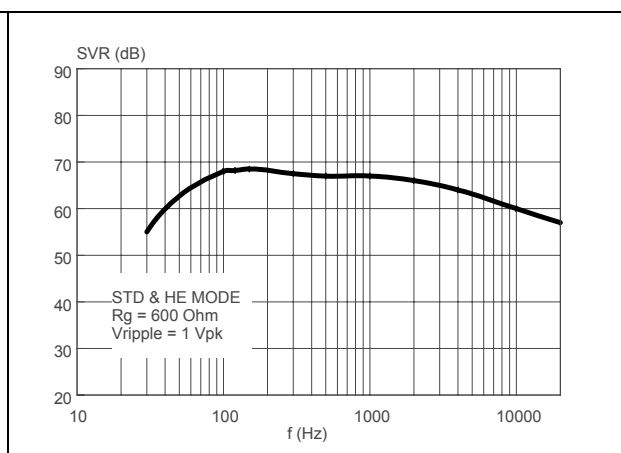

Figure 15. Power Dissipation & Efficiency vs. Output Power (4Ω, STD, SINE)

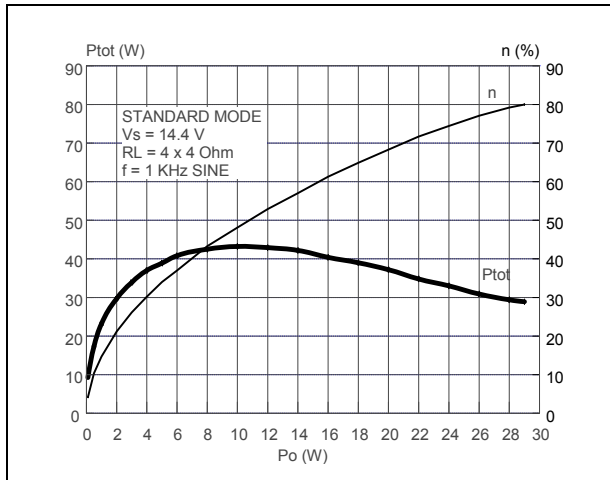

Figure 16. Power Dissipation & Efficiency vs. Output Power (4W, HI-EFF, SINE)

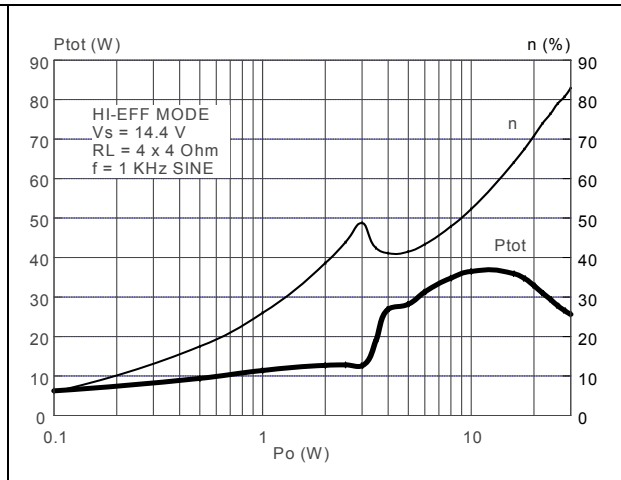

Figure 17. Power Dissipation vs. Average Output Power (Audio Program Simulation, 4Ω)

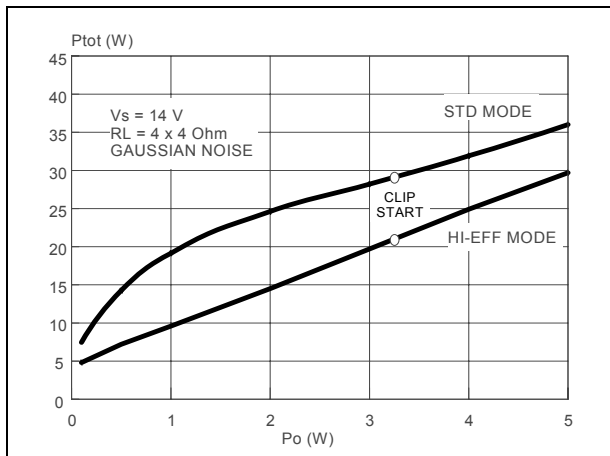
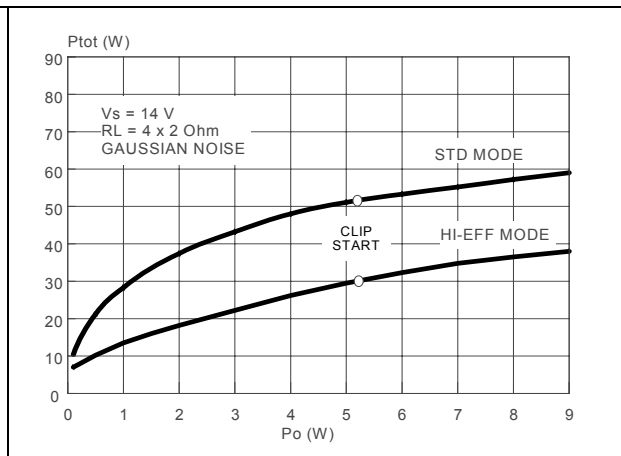

Figure 18. Power Dissipation vs. Average Output Power (Audio Program Simulation, 2Ω)



4 Diagnostics functional description

4.1 Turn-on diagnostic

It is activated at the turn-on (stand-by out) under I²Cbus request. Detectable output faults are:

- SHORT TO GND
- SHORT TO V_s
- SHORT ACROSS THE SPEAKER
- OPEN SPEAKER

To verify if any of the above misconnections are in place, a subsonic (inaudible) current pulse (fig. 19) is internally generated, sent through the speaker(s) and sunk back. The Turn On diagnostic status is internally stored until a successive diagnostic pulse is requested (after a I²C reading).

If the "stand-by out" and "diag. enable" commands are both given through a single programming step, the pulse takes place first (power stage still in stand-by mode, low, outputs= high impedance).

Afterwards, when the Amplifier is biased, the PERMANENT diagnostic takes place. The previous Turn On state is kept until a short appears at the outputs.

Figure 19. Turn - On diagnostic: working principle

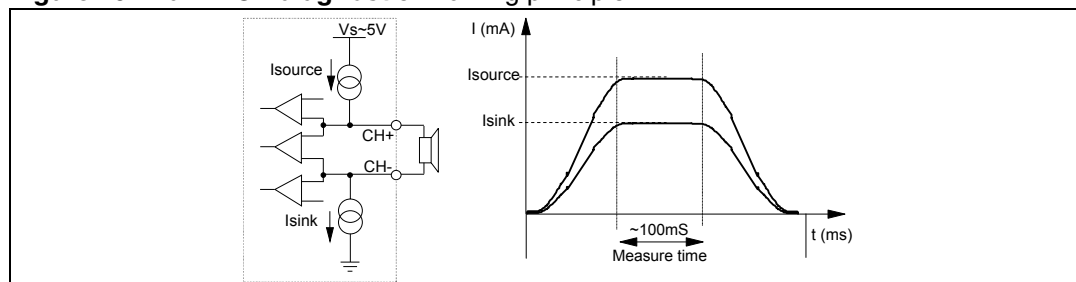

Figure 20 and 21 show SVR and OUTPUT waveforms at the turn-on (stand-by out) with and without turn-on diagnostic.

Figure 20. SVR and Output behaviour (Case 1: without turn-on diagnostic)

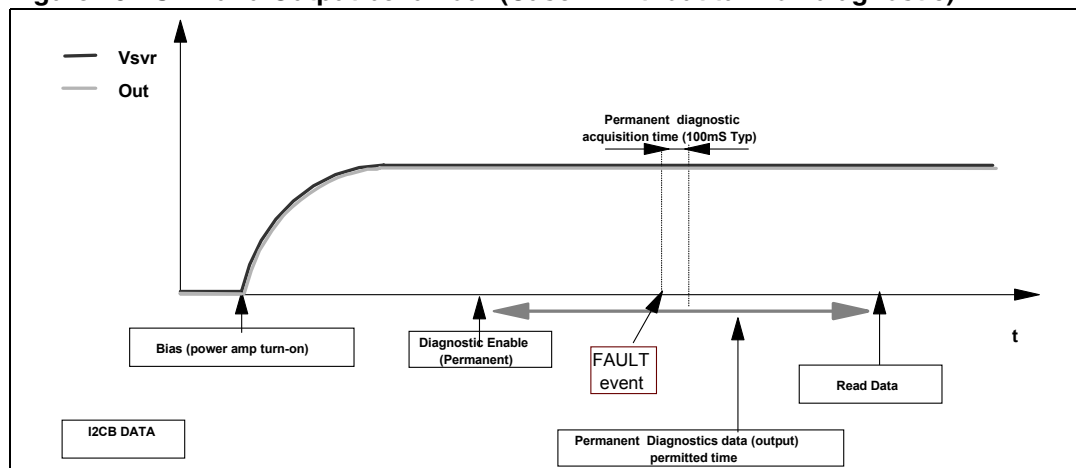
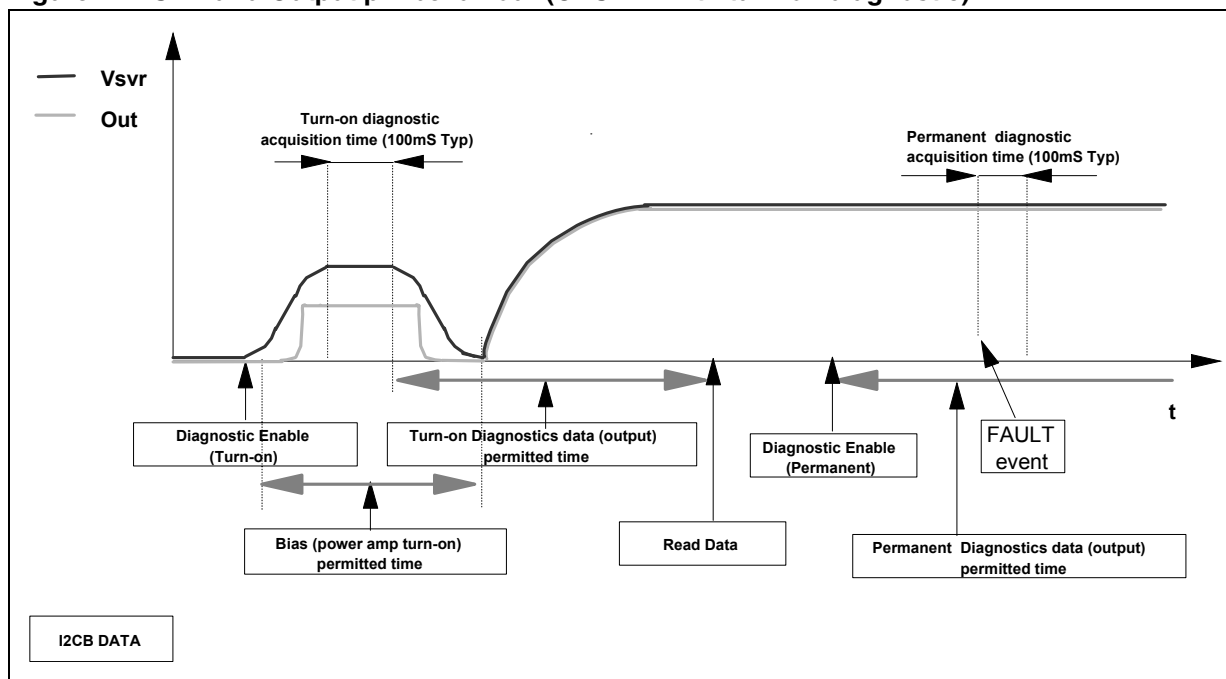
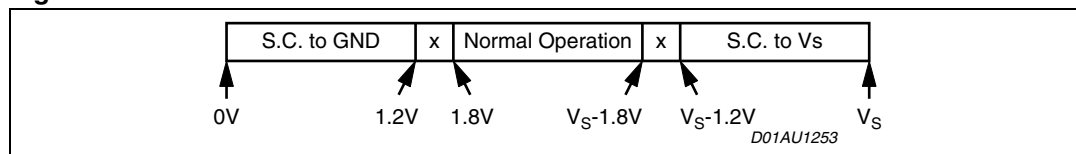

Figure 21. SVR and Output pin behaviour (CASE 2: with turn-on diagnostic)



The information related to the outputs status is read and memorized at the end of the current pulse top. The acquisition time is 100 ms (typ.). No audible noise is generated in the process. As for SHORT TO GND / Vs the fault-detection thresholds remain unchanged from 26 dB to 12 dB gain setting. They are as follows:

Figure 22.



Concerning SHORT ACROSS THE SPEAKER / OPEN SPEAKER, the threshold varies from 26 dB to 12 dB gain setting, since different loads are expected (either normal speaker's impedance or high impedance). The values in case of 26 dB gain are as follows:

Figure 23.

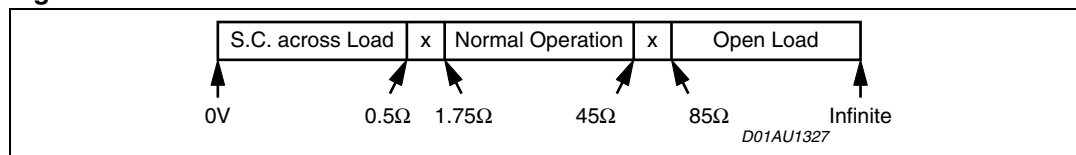

If the Line-Driver mode ($G_v = 12$ dB and Line Driver Mode diagnostic = 1) is selected, the same thresholds will change as follows:

Figure 24.

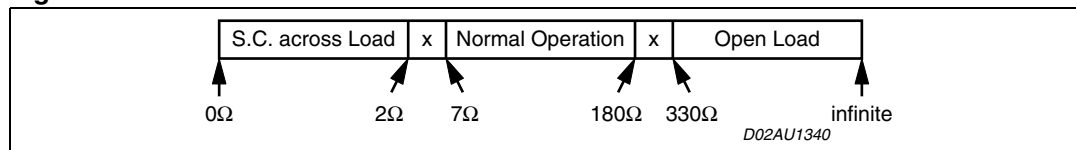

4.2 Permanent diagnostics

Detectable conventional faults are:

- SHORT TO GND
- SHORT TO Vs
- SHORT ACROSS THE SPEAKER

The following additional features are provided:

- OUTPUT OFFSET DETECTION

The TDA7564B has 2 operating statuses:

1. **RESTART mode.** The diagnostic is not enabled. Each audio channel operates independently from each other. If any of the a.m. faults occurs, only the channel(s) interested is shut down. A check of the output status is made every 1 ms (*Figure 25*). Restart takes place when the overload is removed.
2. **DIAGNOSTIC mode.** It is enabled via I²C bus and self activates if an output overload (such to cause the intervention of the short-circuit protection) occurs to the speakers outputs . Once activated, the diagnostics procedure develops as follows (*Figure 26*):
 - To avoid momentary re-circulation spikes from giving erroneous diagnostics, a check of the output status is made after 1ms: if normal situation (no overloads) is detected, the diagnostic is not performed and the channel returns back active.
 - Instead, if an overload is detected during the check after 1 ms, then a diagnostic cycle having a duration of about 100 ms is started.
 - After a diagnostic cycle, the audio channel interested by the fault is switched to RESTART mode. The relevant data are stored inside the device and can be read by the microprocessor. When one cycle has terminated, the next one is activated by an I²C reading. This is to ensure continuous diagnostics throughout the car-radio operating time.
 - To check the status of the device a sampling system is needed. The timing is chosen at microprocessor level (over half a second is recommended).

Figure 25. Restart timing without Diagnostic Enable (Permanent) - Each 1mS time, a sampling of the fault is done

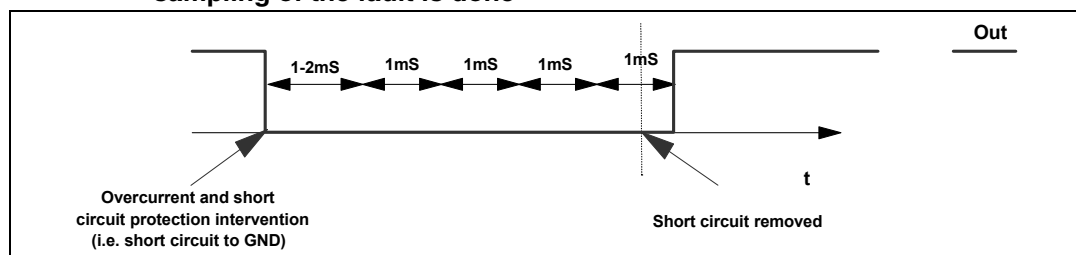
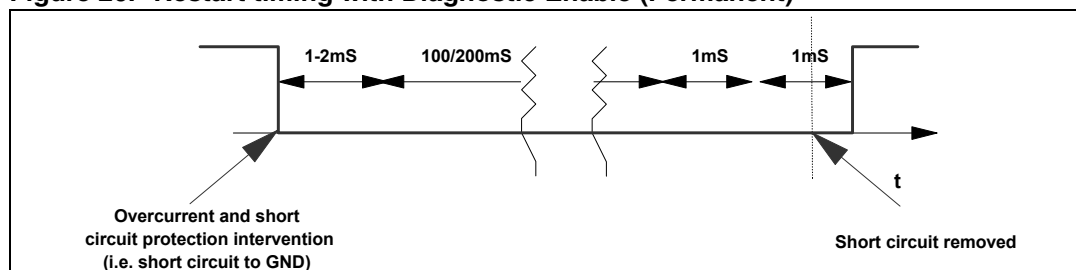

Figure 26. Restart timing with Diagnostic Enable (Permanent)



4.3 Output DC offset detection

Any DC output offset exceeding ± 2 V are signalled out. This inconvenient might occur as a consequence of initially defective or aged and worn-out input capacitors feeding a DC component to the inputs, so putting the speakers at risk of overheating.

This diagnostic has to be performed with low-level output AC signal (or $V_{in} = 0$).

The test is run with selectable time duration by microprocessor (from a "start" to a "stop" command):

- START = Last reading operation or setting IB1 - D5 - (OFFSET enable) to 1
- STOP = Actual reading operation

Excess offset is signalled out if persistent throughout the assigned testing time. This feature is disabled if any overloads leading to activation of the short-circuit protection occurs in the process.

4.4 AC diagnostic

It is targeted at detecting accidental disconnection of tweeters in 2-way speaker and, more in general, presence of capacitively (AC) coupled loads.

This diagnostic is based on the notion that the overall speaker's impedance (woofer + parallel tweeter) will tend to increase towards high frequencies if the tweeter gets disconnected, because the remaining speaker (woofer) would be out of its operating range (high impedance). The diagnostic decision is made according to peak output current thresholds, and it is enabled by setting (IB2-D2) = 1. Two different detection levels are available:

- HIGH CURRENT THRESHOLD IB2 (D7) = 0
 - $I_{out} > 500\text{mA}_{pk}$ = NORMAL STATUS
 - $I_{out} < 250\text{mA}_{pk}$ = OPEN TWEETER
- LOW CURRENT THRESHOLD IB2 (D7) = 1
 - $I_{out} > 250\text{mA}_{pk}$ = NORMAL STATUS
 - $I_{out} < 125\text{mA}_{pk}$ = OPEN TWEETER

To correctly implement this feature, it is necessary to briefly provide a signal tone (with the amplifier in "play") whose frequency and magnitude are such to determine an output current higher than 500mA_{pk} with IB2(D7)=0 (higher than 250mA_{pk} with IB2(D7)=1) in normal conditions and lower than 250mA_{pk} with IB2(D7)=0 (lower than 125mA_{pk} with IB2(D7)=1) should the parallel tweeter be missing.

The test has to last for a minimum number of 3 sine cycles starting from the activation of the AC diagnostic function IB2<D2>) up to the I²C reading of the results (measuring period). To confirm presence of tweeter, it is necessary to find at least 3 current pulses over the above thresholds over all the measuring period, else an "open tweeter" message will be issued.

The frequency / magnitude setting of the test tone depends on the impedance characteristics of each specific speaker being used, with or without the tweeter connected (to be calculated case by case). High-frequency tones (> 10 KHz) or even ultrasonic signals are recommended for their negligible acoustic impact and also to maximize the impedance module's ratio between with tweeter-on and tweeter-off.

Figure 27 shows the Load Impedance as a function of the peak output voltage and the relevant diagnostic fields. This feature is disabled if any overloads leading to activation of the short-circuit protection occurs in the process.

Figure 27. Current detection high: Load impedance $|Z|$ vs. output peak voltage

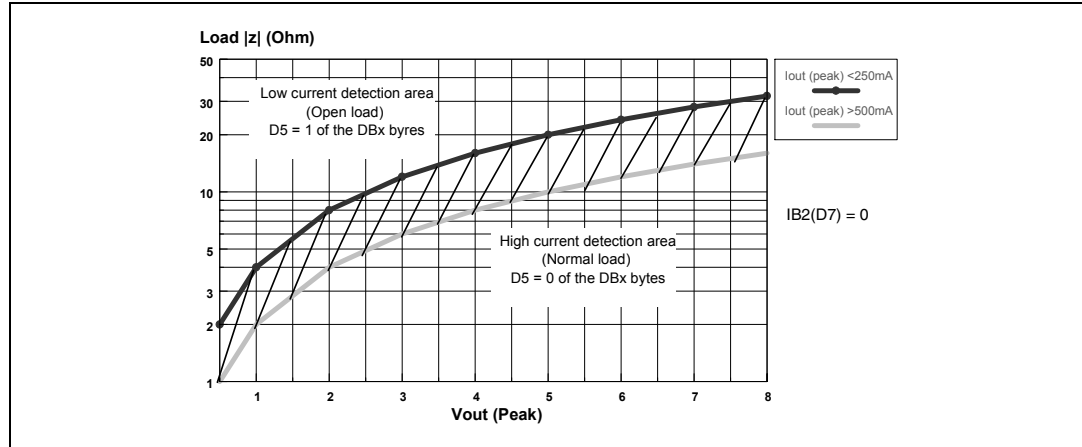
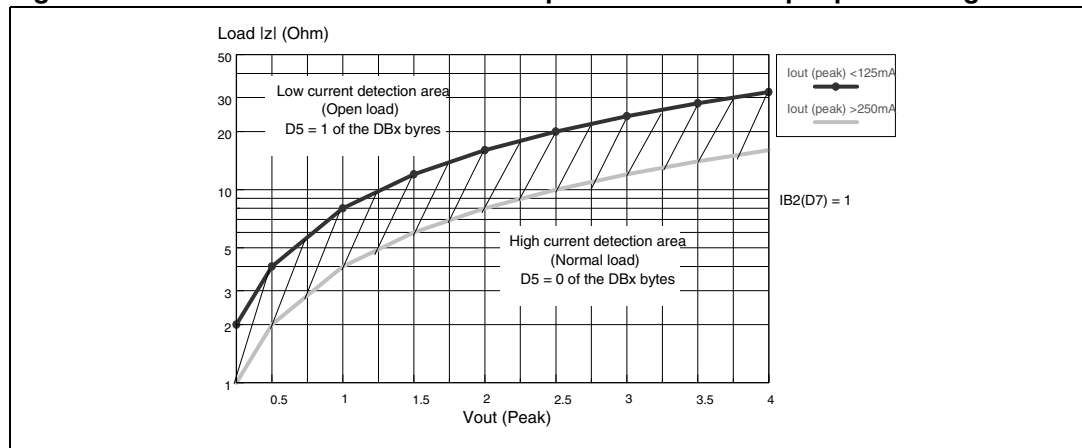

Figure 28. Current detection low: Load impedance $|Z|$ vs. output peak voltage



5 Multiple faults

When more misconnections are simultaneously in place at the audio outputs, it is guaranteed that at least one of them is initially read out. The others are notified after successive cycles of I²C reading and faults removal, provided that the diagnostic is enabled. This is true for both kinds of diagnostic (Turn on and Permanent).

The table below shows all the couples of double-fault possible. It should be taken into account that a short circuit with the 4 ohm speaker unconnected is considered as double fault.

Table 4. Double fault table for Turn On Diagnostic

	S. GND (so)	S. GND (sk)	S. Vs	S. Across L.	Open L.
S. GND (so)	S. GND	S. GND	S. Vs + S. GND	S. GND	S. GND
S. GND (sk)	/	S. GND	S. Vs	S. GND	Open L. (*)
S. Vs	/	/	S. Vs	S. Vs	S. Vs
S. Across L.	/	/	/	S. Across L.	N.A.
Open L.	/	/	/	/	Open L. (*)

S. GND (so) / S. GND (sk) in the above table make a distinction according to which of the 2 outputs is shorted to ground (test-current source side= so, test-current sink side = sk). More precisely, in Channels LF and RR, so = CH+, sk = CH-; in Channels LR and RF, so = CH-, sk = CH+.

In Permanent Diagnostic the table is the same, with only a difference concerning Open Load(*), which is not among the recognisable faults. Should an Open Load be present during the device's normal working, it would be detected at a subsequent Turn on Diagnostic cycle (i.e. at the successive Car Radio Turn on).

5.1 Faults availability

All the results coming from I²Cbus, by read operations, are the consequence of measurements inside a defined period of time. If the fault is stable throughout the whole period, it will be sent out.

To guarantee always resident functions, every kind of diagnostic cycles (Turn on, Permanent, Offset) will be reactivate after any I²C reading operation. So, when the micro reads the I²C, a new cycle will be able to start, but the read data will come from the previous diag. cycle (i.e. The device is in Turn On state, with a short to Gnd, then the short is removed and micro reads I²C. The short to Gnd is still present in bytes, because it is the result of the previous cycle. If another I²C reading operation occurs, the bytes do not show the short). In general to observe a change in Diagnostic bytes, two I²C reading operations are necessary.

6 Thermal protection

Thermal protection is implemented through thermal foldback ([Figure 29](#)).

Thermal foldback begins limiting the audio input to the amplifier stage as the junction temperatures rise above the normal operating range. This effectively limits the output power capability of the device thus reducing the temperature to acceptable levels without totally interrupting the operation of the device.

The output power will decrease to the point at which thermal equilibrium is reached. Thermal equilibrium will be reached when the reduction in output power reduces the dissipated power such that the die temperature falls below the thermal foldback threshold. Should the device cool, the audio level will increase until a new thermal equilibrium is reached or the amplifier reaches full power. Thermal foldback will reduce the audio output level in a linear manner.

Three Thermal warning are available through the I²C bus data.

Figure 29. Thermal Foldback Diagram

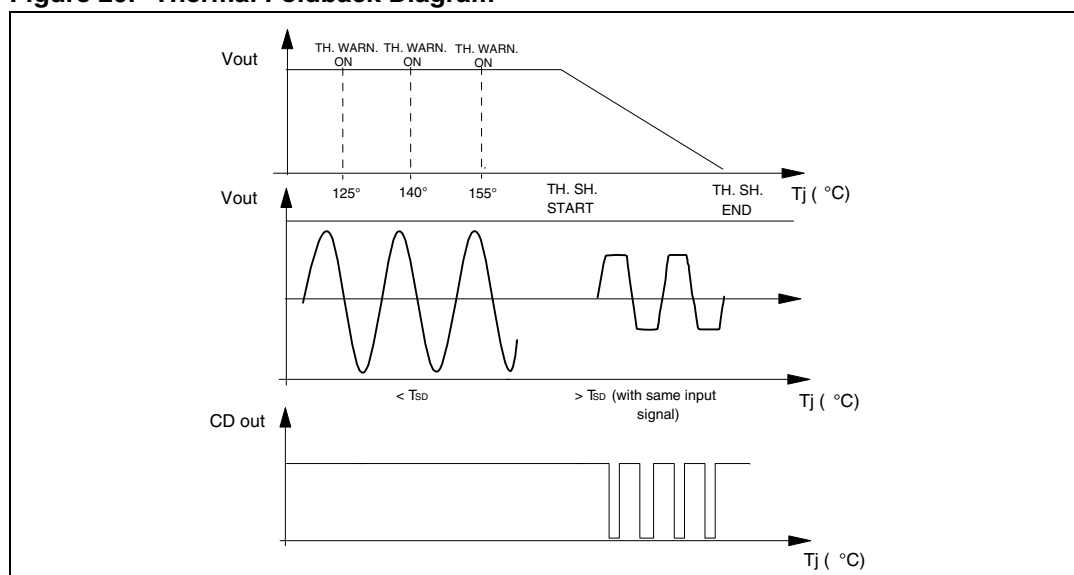

6.1 I²C programming/reading sequences

A correct turn on/off sequence respectful of the diagnostic timings and producing no audible noises could be as follows (after battery connection):

TURN-ON: (STAND-BY OUT + DIAG ENABLE) --- 500 ms (min) --- MUTING OUT

TURN-OFF: MUTING IN --- 20 ms --- (DIAG DISABLE + STAND-BY IN)

Car Radio Installation: DIAG ENABLE (write) --- 200 ms --- I²C read (repeat until All faults disappear).

AC TEST: FEED H.F. TONE -- AC DIAG ENABLE (write) --- WAIT > 3 CYCLES --- I²C read (repeat I²C reading until tweeter-off message disappears).

OFFSET TEST: Device in Play (no signal) -- OFFSET ENABLE - 30ms - I²C reading (repeat I²C reading until high-offset message disappears).

7 Fast muting

The muting time can be shortened to less than 1.5ms by setting (IB2) D5 = 1. This option can be useful in transient battery situations (i.e. during car engine cranking) to quickly turnoff the amplifier for avoiding any audible effects caused by noise/transients being injected by preamp stages. The bit must be set back to "0" shortly after the mute transition.

8 I²C Bus interface

Data transmission from microprocessor to the TDA7564B and viceversa takes place through the 2 wires I²C BUS interface, consisting of the two lines SDA and SCL (pull-up resistors to positive supply voltage must be connected).

8.0.1 Data Validity

As shown by [Figure 30](#), the data on the SDA line must be stable during the high period of the clock. The HIGH and LOW state of the data line can only change when the clock signal on the SCL line is LOW.

8.0.2 Start and Stop Conditions

As shown by [Figure 31](#) a start condition is a HIGH to LOW transition of the SDA line while SCL is HIGH. The stop condition is a LOW to HIGH transition of the SDA line while SCL is HIGH.

8.0.3 Byte Format

Every byte transferred to the SDA line must contain 8 bits. Each byte must be followed by an acknowledge bit. The MSB is transferred first.

8.0.4 Acknowledge

The transmitter* puts a resistive HIGH level on the SDA line during the acknowledge clock pulse (see [Figure 32](#)). The receiver** the acknowledges has to pull-down (LOW) the SDA line during the acknowledge clock pulse, so that the SDA line is stable LOW during this clock pulse.

* Transmitter

- master (μ P) when it writes an address to the TDA7564B
- slave (TDA7564B) when the μ P reads a data byte from TDA7564B

** Receiver

- slave (TDA7564B) when the μ P writes an address to the TDA7564B
- master (μ P) when it reads a data byte from TDA7564B

Figure 30. Data Validity on the I²C BUS

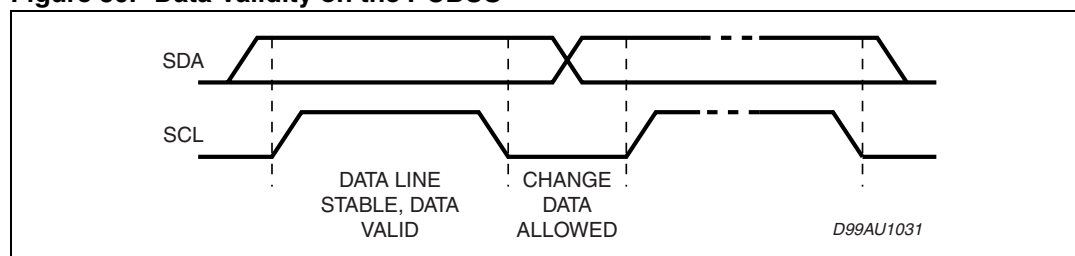

Figure 31. Timing Diagram on the I²C BUS

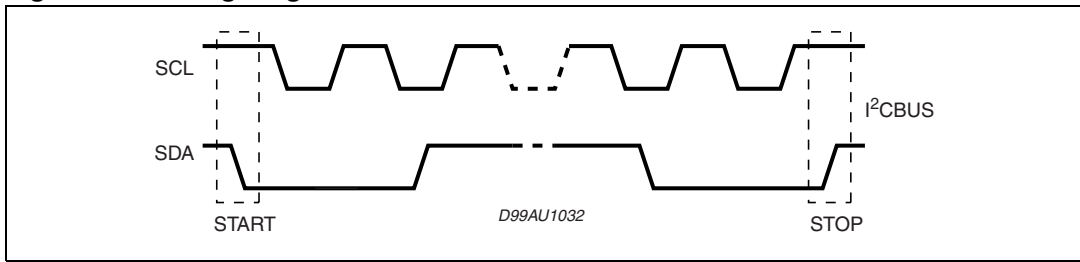
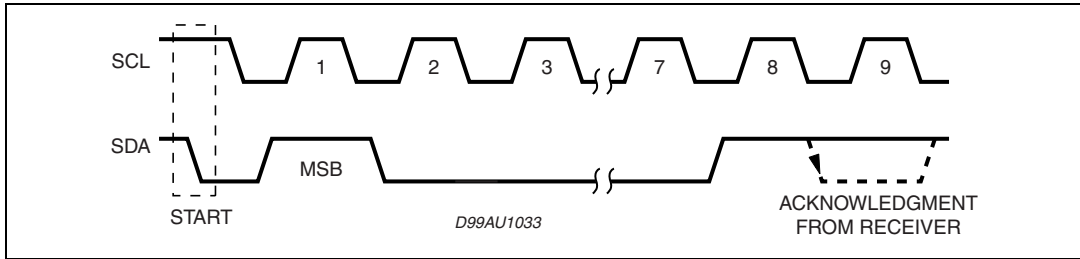

Figure 32. Acknowledge on the I²C BUS



9 Software specifications

All the functions of the TDA7564B are activated by I²C interface.

The bit 0 of the "ADDRESS BYTE" defines if the next bytes are write instruction (from μ P to TDA7564B) or read instruction (from TDA7564B to μ P).

Table 5. Chip Address:

D7							D0	D8 Hex
1	1	0	1	1	0	0	X	

X = 0 Write to device

X = 1 Read from device

If R/W = 0, the μ P sends 2 "Instruction Bytes": IB1 and IB2.

Table 6. IB1

D7	0
D6	Diagnostic enable (D6 = 1) Diagnostic defeat (D6 = 0)
D5	Offset Detection enable (D5 = 1) Offset Detection defeat (D5 = 0)
D4	Front Channel Gain = 26dB (D4 = 0) Gain = 12dB (D4 = 1)
D3	Rear Channel Gain = 26dB (D3 = 0) Gain = 12dB (D3 = 1)
D2	Mute front channels (D2 = 0) Unmute front channels (D2 = 1)
D1	Mute rear channels (D1 = 0) Unmute rear channels (D1 = 1)
D0	Clip detector 2% (D0 = 0) Clip detector 10% (D0 = 1)

Table 7. IB2

D7	current detection threshold High th (D7 = 0) Low th (D7 = 1)
D6	0
D5	Normal muting time (D5 = 0) Fast muting time (D5 = 1)
D4	Stand-by on - Amplifier not working - (D4 = 0) Stand-by off - Amplifier working - (D4 = 1)

Table 7. IB2 (continued)

D3	Power amplifier mode diagnostic (D3 = 0) Line driver mode diagnostic (D3 = 1)
D2	Current detection diagnostic enabled (D2 = 1) Current detection diagnostic defeat (D2 = 0)
D1	Right Channels Power amplifier working in standard mode (D1 = 0) Power amplifier working in high efficiency mode (D1 = 1)
D0	Left Channels Power amplifier working in standard mode (D0 = 0) Power amplifier working in high efficiency mode (D0 = 1)

If R/W = 1, the TDA7564B sends 4 "Diagnostics Bytes" to μ P: DB1, DB2, DB3 and DB4.

Table 8. DB1

D7	Thermal warning 1 active (D7 = 1) T=155 °C						
D6	Diag. cycle not activated or not terminated (D6 = 0) Diag. cycle terminated (D6 = 1)						
D5	<table border="0" style="width: 100%;"> <tr> <td style="width: 50%;">Channel LF current detection IB2 (D7) = 0</td> <td style="width: 50%;">Channel LF current detection IB2 (D7) = 1</td> </tr> <tr> <td>Output peak current < 250 mA - Open load (D5 = 1)</td> <td>Output peak current < 125 mA - Open load (D5 = 1)</td> </tr> <tr> <td>Output peak current > 500 mA - Normal load (D5 = 0)</td> <td>Output peak current > 250 mA - Normal load (D5 = 0)</td> </tr> </table>	Channel LF current detection IB2 (D7) = 0	Channel LF current detection IB2 (D7) = 1	Output peak current < 250 mA - Open load (D5 = 1)	Output peak current < 125 mA - Open load (D5 = 1)	Output peak current > 500 mA - Normal load (D5 = 0)	Output peak current > 250 mA - Normal load (D5 = 0)
Channel LF current detection IB2 (D7) = 0	Channel LF current detection IB2 (D7) = 1						
Output peak current < 250 mA - Open load (D5 = 1)	Output peak current < 125 mA - Open load (D5 = 1)						
Output peak current > 500 mA - Normal load (D5 = 0)	Output peak current > 250 mA - Normal load (D5 = 0)						
D4	Channel LF Turn-on diagnostic (D4 = 0) Permanent diagnostic (D4 = 1)						
D3	Channel LF Normal load (D3 = 0) Short load (D3 = 1)						
D2	Channel LF Turn-on diag.: No open load (D2 = 0) Open load detection (D2 = 1) Offset diag.: No output offset (D2 = 0) Output offset detection (D2 = 1)						
D1	Channel LF No short to Vcc (D1 = 0) Short to Vcc (D1 = 1)						
D0	Channel LF No short to GND (D1 = 0) Short to GND (D1 = 1)						

Table 9. DB2

D7	Offset detection not activated (D7 = 0) Offset detection activated (D7 = 1)	
D6	Current sensor not activated (D6 = 0) Current sensor activated (D6 = 1)	
D5	Channel LR current detection IB2 (D7) = 0 Output peak current < 250 mA - Open load (D5 = 1) Output peak current > 500 mA - Normal load (D5 = 0)	Channel LR current detection IB2 (D7) = 1 Output peak current < 250 mA - Open load (D5 = 1) Output peak current > 500 mA - Normal load (D5 = 0)
D4	Channel LR Turn-on diagnostic (D4 = 0) Permanent diagnostic (D4 = 1)	
D3	Channel LR Normal load (D3 = 0) Short load (D3 = 1)	
D2	Channel LR Turn-on diag.: No open load (D2 = 0) Open load detection (D2 = 1) Permanent diag.: No output offset (D2 = 0) Output offset detection (D2 = 1)	
D1	Channel LR No short to Vcc (D1 = 0) Short to Vcc (D1 = 1)	
D0	Channel LR No short to GND (D1 = 0) Short to GND (D1 = 1)	

Table 10. DB3

D7	Stand-by status (= IB1 - D4)	
D6	Diagnostic status (= IB1 - D6)	
D5	Channel RF current detection IB2 (D7) = 0 Output peak current < 250 mA - Open load (D5 = 1) Output peak current > 500 mA - Normal load (D5 = 0)	Channel RF current detection IB2 (D7) = 1 Output peak current < 250 mA - Open load (D5 = 1) Output peak current > 500 mA - Normal load (D5 = 0)
D4	Channel RF Turn-on diagnostic (D4 = 0) Permanent diagnostic (D4 = 1)	
D3	Channel RF Normal load (D3 = 0) Short load (D3 = 1)	

Table 10. DB3 (continued)

D7	Stand-by status (= IB1 - D4)
D2	Channel RF Turn-on diag.: No open load (D2 = 0) Open load detection (D2 = 1) Permanent diag.: No output offset (D2 = 0) Output offset detection (D2 = 1)
D1	Channel RF No short to Vcc (D1 = 0) Short to Vcc (D1 = 1)
D0	Channel RF No short to GND (D1 = 0) Short to GND (D1 = 1)

Table 11. DB4

D7	Thermal warning 2 active (D7 = 1) T=140°C	
D6	Thermal warning 3 active (D6 = 1) T=125°C	
D5	Channel RR current detection IB2 (D7) = 0 Output peak current < 250 mA - Open load (D5 = 1) Output peak current > 500 mA - Normal load (D5 = 0)	Channel RR current detection IB2 (D7) = 1 Output peak current < 250 mA - Open load (D5 = 1) Output peak current > 500 mA - Normal load (D5 = 0)
D4	Channel RR Turn-on diagnostic (D4 = 0) Permanent diagnostic (D4 = 1)	
D3	Channel RR Normal load (D3 = 0) Short load (D3 = 1)	
D2	Channel RR Turn-on diag.: No open load (D2 = 0) Open load detection (D2 = 1) Permanent diag.: No output offset (D2 = 0) Output offset detection (D2 = 1)	
D1	Channel RR No short to Vcc (D1 = 0) Short to Vcc (D1 = 1)	
D0	Channel RR No short to GND (D1 = 0) Short to GND (D1 = 1)	

10 Examples of bytes sequence

1 - Turn-On diagnostic - Write operation

Start	Address byte with D0 = 0	ACK	IB1 with D6 = 1	ACK	IB2	ACK	STOP
-------	--------------------------	-----	-----------------	-----	-----	-----	------

2 - Turn-On diagnostic - Read operation

Start	Address byte with D0 = 1	ACK	DB1	ACK	DB2	ACK	DB3	ACK	DB4	ACK	STOP
-------	--------------------------	-----	-----	-----	-----	-----	-----	-----	-----	-----	------

The delay from 1 to 2 can be selected by software, starting from 1 ms

3a - Turn-On of the power amplifier with 26dB gain, mute on, diagnostic defeat, High eff. mode both channels.

Start	Address byte with D0 = 0	ACK	IB1	ACK	IB2	ACK	STOP
			X000000X		XXX1X011		

3b - Turn-Off of the power amplifier

Start	Address byte with D0 = 0	ACK	IB1	ACK	IB2	ACK	STOP
			X0XXXXXX		XXX0XXXX		

4 - Offset detection procedure enable

Start	Address byte with D0 = 0	ACK	IB1	ACK	IB2	ACK	STOP
			XX1XX11X		XXX1X0XX		

5 - Offset detection procedure stop and reading operation (the results are valid only for the offset detection bits (D2 of the bytes DB1, DB2, DB3, DB4)

Start	Address byte with D0 = 1	ACK	DB1	ACK	DB2	ACK	DB3	ACK	DB4	ACK	STOP
-------	--------------------------	-----	-----	-----	-----	-----	-----	-----	-----	-----	------

- The purpose of this test is to check if a D.C. offset (2V typ.) is present on the outputs, produced by input capacitor with anomalous leakage current or humidity between pins.
- The delay from 4 to 5 can be selected by software, starting from 1ms

6 - Current detection procedure start (the AC inputs must be with a proper signal that depends on the type of load)

Start	Address byte with D0 = 0	ACK	IB1	ACK	IB2	ACK	STOP
			XX01111X		XXX1X1XX		

Current detection reading operation (the results valid only for the current sensor detection bits - D5 of the bytes DB1, DB2, DB3, DB4)

Start	Address byte with D0 = 1	ACK	DB1	ACK	DB2	ACK	DB3	ACK	DB4	ACK	STOP
-------	--------------------------	-----	-----	-----	-----	-----	-----	-----	-----	-----	------

- During the test, a sinus wave with a proper amplitude and frequency (depending on the loudspeaker under test) must be present. The minimum number of periods that are needed to detect a normal load is 5.
- The delay from 6 to 7 can be selected by software, starting from 1ms.

11 Package information

In order to meet environmental requirements, ST offers these devices in ECOPACK[®] packages. These packages have a Lead-free second level interconnect. The category of second Level Interconnect is marked on the package and on the inner box label, in compliance with JEDEC Standard JESD97. The maximum ratings related to soldering conditions are also marked on the inner box label. ECOPACK is an ST trademark. ECOPACK specifications are available at: www.st.com.

Figure 33. Flexiwatt25 (horizontal) Mechanical Data & Package Dimensions

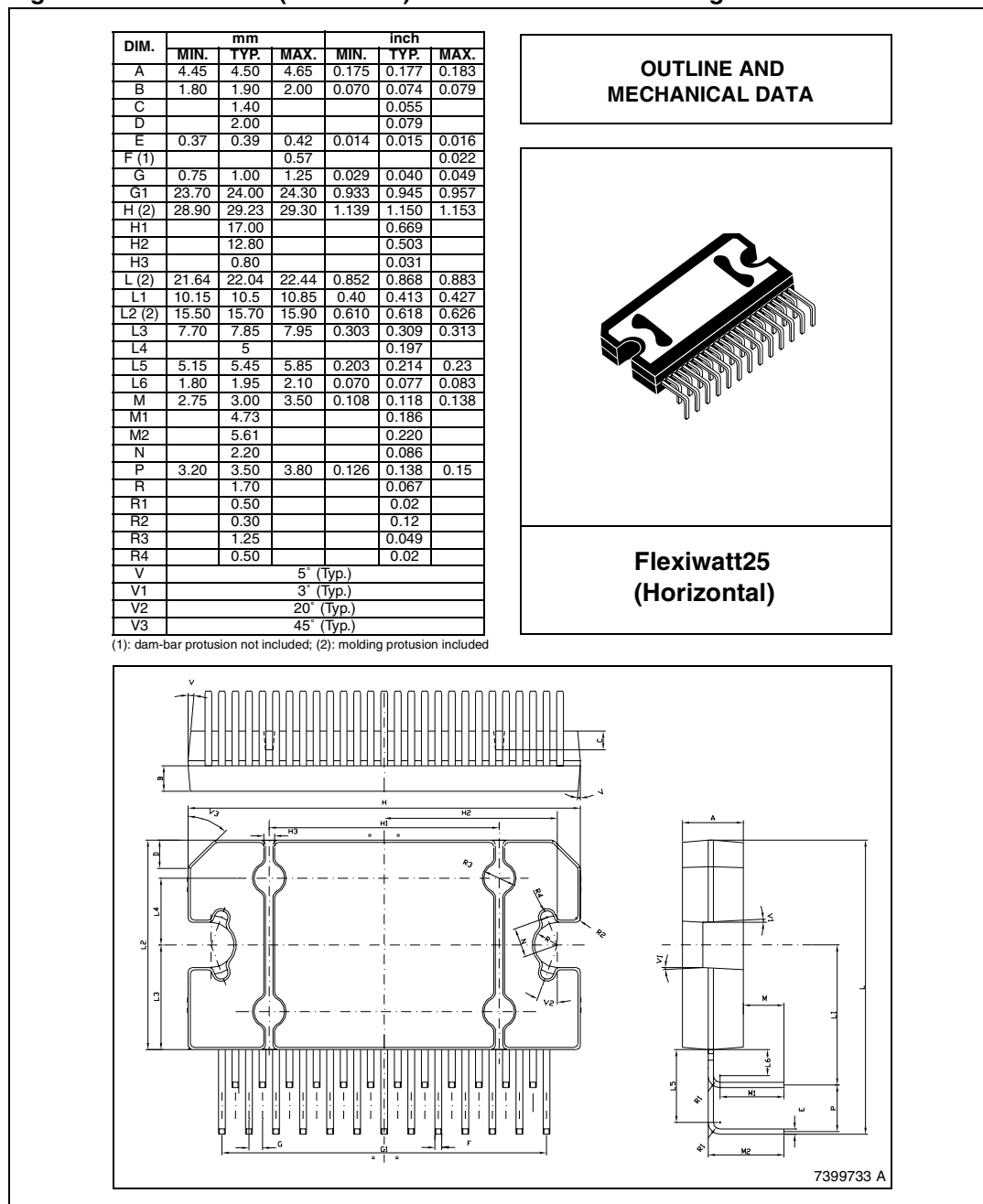
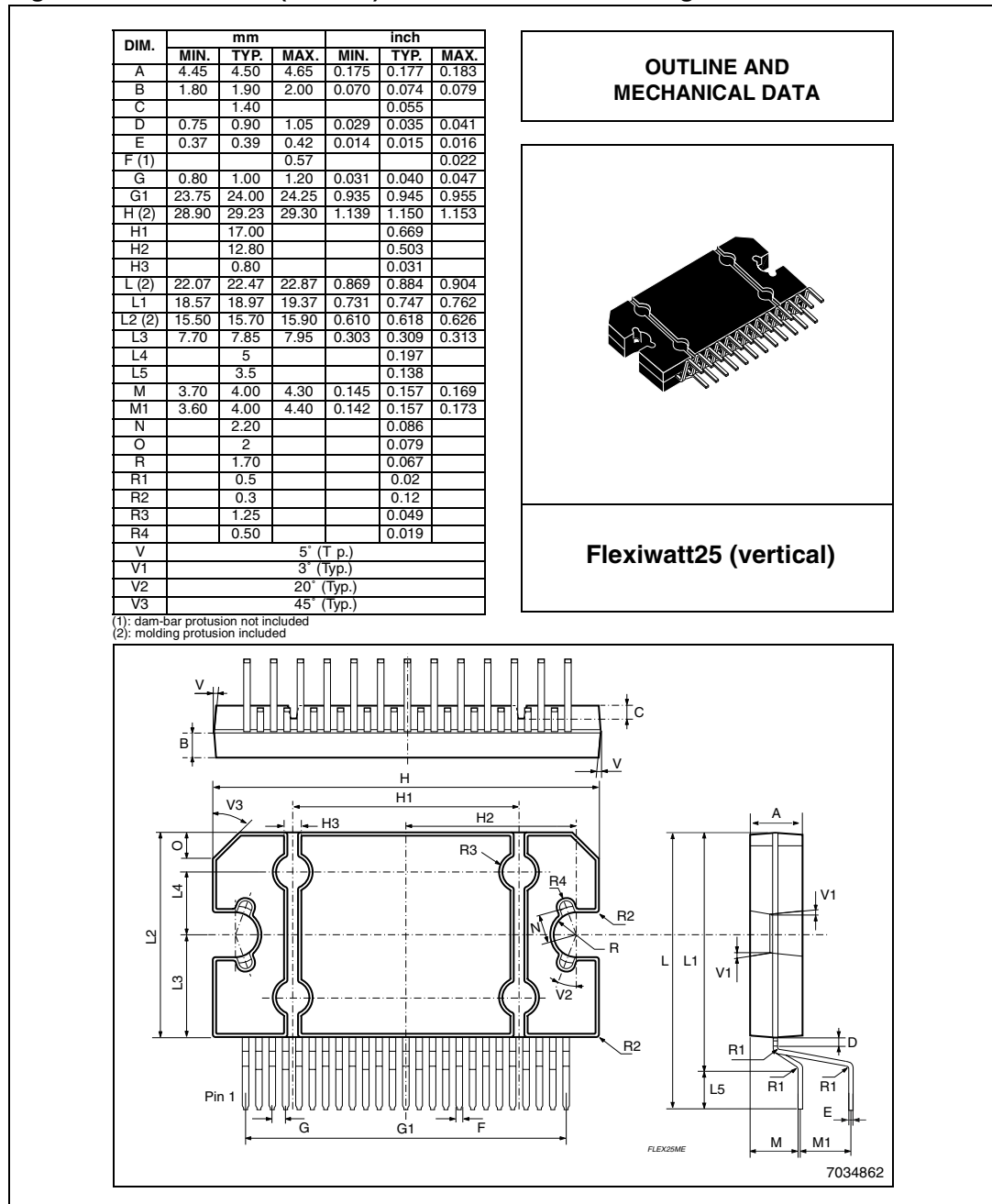

Figure 34. Flexiwatt25 (vertical) Mechanical Data & Package Dimensions



12 Revision history

Table 12. Document revision history

Date	Revision	Changes
14-Sep-2006	1	Initial release.

Please Read Carefully:

Information in this document is provided solely in connection with ST products. STMicroelectronics NV and its subsidiaries ("ST") reserve the right to make changes, corrections, modifications or improvements, to this document, and the products and services described herein at any time, without notice.

All ST products are sold pursuant to ST's terms and conditions of sale.

Purchasers are solely responsible for the choice, selection and use of the ST products and services described herein, and ST assumes no liability whatsoever relating to the choice, selection or use of the ST products and services described herein.

No license, express or implied, by estoppel or otherwise, to any intellectual property rights is granted under this document. If any part of this document refers to any third party products or services it shall not be deemed a license grant by ST for the use of such third party products or services, or any intellectual property contained therein or considered as a warranty covering the use in any manner whatsoever of such third party products or services or any intellectual property contained therein.

UNLESS OTHERWISE SET FORTH IN ST'S TERMS AND CONDITIONS OF SALE ST DISCLAIMS ANY EXPRESS OR IMPLIED WARRANTY WITH RESPECT TO THE USE AND/OR SALE OF ST PRODUCTS INCLUDING WITHOUT LIMITATION IMPLIED WARRANTIES OF MERCHANTABILITY, FITNESS FOR A PARTICULAR PURPOSE (AND THEIR EQUIVALENTS UNDER THE LAWS OF ANY JURISDICTION), OR INFRINGEMENT OF ANY PATENT, COPYRIGHT OR OTHER INTELLECTUAL PROPERTY RIGHT.

UNLESS EXPRESSLY APPROVED IN WRITING BY AN AUTHORIZED ST REPRESENTATIVE, ST PRODUCTS ARE NOT RECOMMENDED, AUTHORIZED OR WARRANTED FOR USE IN MILITARY, AIR CRAFT, SPACE, LIFE SAVING, OR LIFE SUSTAINING APPLICATIONS, NOR IN PRODUCTS OR SYSTEMS WHERE FAILURE OR MALFUNCTION MAY RESULT IN PERSONAL INJURY, DEATH, OR SEVERE PROPERTY OR ENVIRONMENTAL DAMAGE. ST PRODUCTS WHICH ARE NOT SPECIFIED AS "AUTOMOTIVE GRADE" MAY ONLY BE USED IN AUTOMOTIVE APPLICATIONS AT USER'S OWN RISK.

Resale of ST products with provisions different from the statements and/or technical features set forth in this document shall immediately void any warranty granted by ST for the ST product or service described herein and shall not create or extend in any manner whatsoever, any liability of ST.

ST and the ST logo are trademarks or registered trademarks of ST in various countries.

Information in this document supersedes and replaces all information previously supplied.

The ST logo is a registered trademark of STMicroelectronics. All other names are the property of their respective owners.

© 2006 STMicroelectronics - All rights reserved

STMicroelectronics group of companies

Australia - Belgium - Brazil - Canada - China - Czech Republic - Finland - France - Germany - Hong Kong - India - Israel - Italy - Japan - Malaysia - Malta - Morocco - Singapore - Spain - Sweden - Switzerland - United Kingdom - United States of America

www.st.com