

# DATA SHEET

## **TDA8547TS**

**2 × 0.7 W BTL audio amplifier with  
output channel switching**

Product specification  
Supersedes data of 1997 Oct 14

1998 Apr 01



## 2 × 0.7 W BTL audio amplifier with output channel switching

## TDA8547TS

### FEATURES

- Selection between output channels
- Flexibility in use
- Few external components
- Low saturation voltage of output stage
- Gain can be fixed with external resistors
- Standby mode controlled by CMOS compatible levels
- Low standby current
- No switch-on/switch-off plops
- High supply voltage ripple rejection
- Protected against electrostatic discharge
- Outputs short-circuit safe to ground,  $V_{CC}$  and across the load
- Thermally protected.

### APPLICATIONS

- Telecommunication equipment
- Portable consumer products
- Personal computers
- Motor-driver (servo).

### GENERAL DESCRIPTION

The TDA8547TS is a two channel audio power amplifier for an output power of 2 × 0.7 W with a 16 Ω load at a 5 V supply. At a low supply voltage of 3.3 V an output power of 0.6 W with an 8 Ω load can be obtained. The circuit contains two BTL amplifiers with a complementary PNP-NPN output stage and standby/mute logic. The operating condition of all channels of the device (standby, mute or on) is externally controlled by the MODE pin. With the SELECT pin one of the output channels can be switched in the standby condition. This feature can be used for loudspeaker selection and also reduces the quiescent current consumption. When only one channel is used the maximum output power is 1.2 W.

### QUICK REFERENCE DATA

SYMBOL	PARAMETER	CONDITIONS	MIN.	TYP.	MAX.	UNIT
$V_{CC}$	supply voltage		2.2	5	18	V
$I_q$	quiescent current	$V_{CC} = 5\text{ V}$ ; 2 channels	–	15	22	mA
		$V_{CC} = 5\text{ V}$ ; 1 channel	–	8	12	mA
$I_{stb}$	standby current		–	–	10	μA
$P_o$	output power two channels	THD = 10%; $R_L = 8\ \Omega$ ; $V_{CC} = 3.3\text{ V}$	0.5	0.6	–	W
		THD = 10%; $R_L = 16\ \Omega$ ; $V_{CC} = 5\text{ V}$	0.6	0.7	–	W
	one channel	THD = 10%; $R_L = 8\ \Omega$ ; $V_{CC} = 5\text{ V}$	1	1.2	–	W
		THD = 10%; $R_L = 4\ \Omega$ ; $V_{CC} = 3.3\text{ V}$	1	1.2	–	W
THD	total harmonic distortion	$P_o = 0.4\text{ W}$	–	0.15	–	%
SVRR	supply voltage ripple rejection		50	–	–	dB

### ORDERING INFORMATION

TYPE NUMBER	PACKAGE		
	NAME	DESCRIPTION	VERSION
TDA8547TS	SSOP20	plastic shrink small outline package; 20 leads; body width 4.4 mm	SOT266-1

2 × 0.7 W BTL audio amplifier with output channel switching

TDA8547TS

BLOCK DIAGRAM

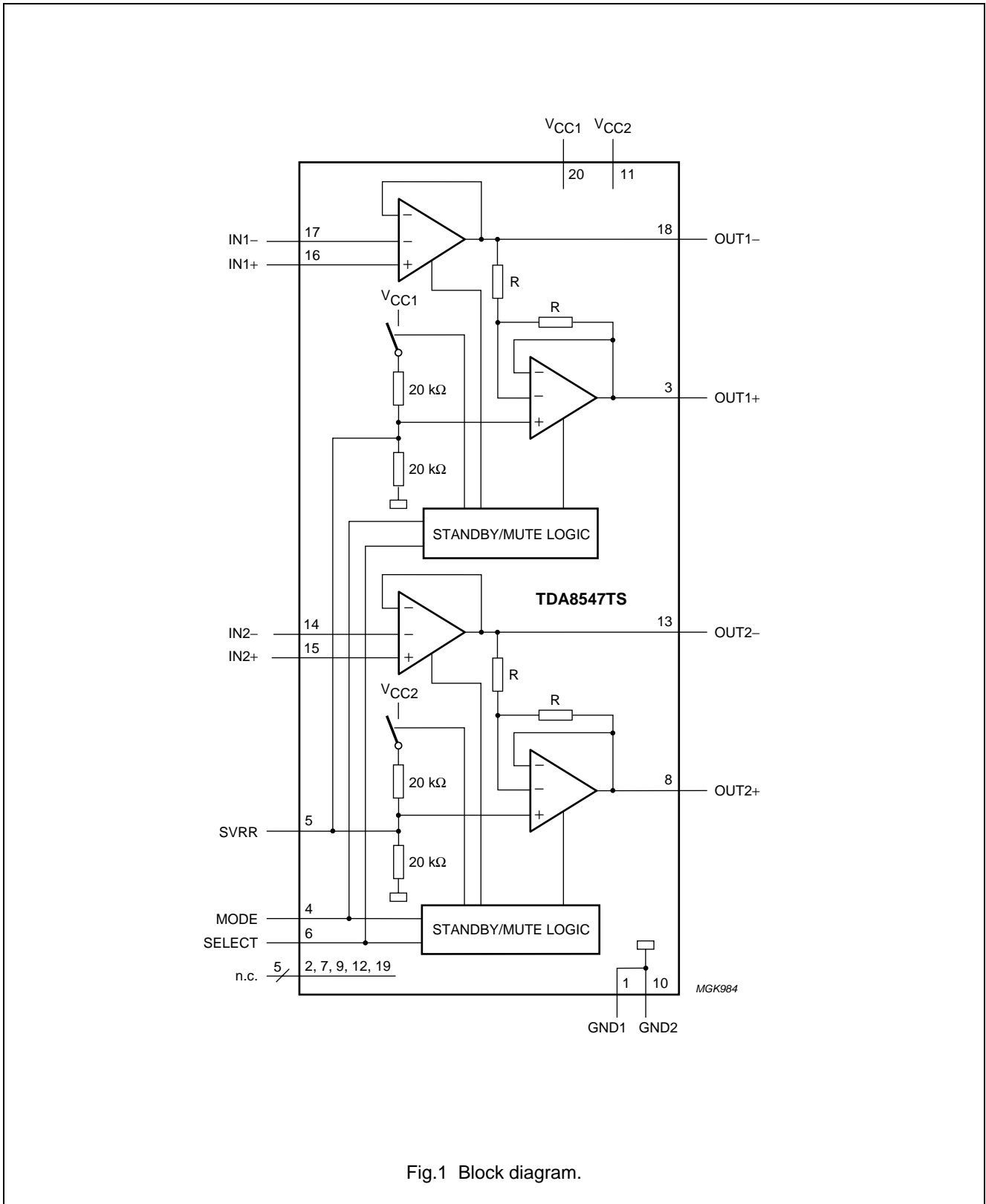

Fig.1 Block diagram.

# 2 × 0.7 W BTL audio amplifier with output channel switching

## TDA8547TS

### PINNING

SYMBOL	PIN	DESCRIPTION
GND1	1	ground, channel 1
n.c.	2	not connected
OUT1+	3	positive loudspeaker terminal, channel 1
MODE	4	operating mode select (standby, mute, operating)
SVRR	5	half supply voltage, decoupling ripple rejection
SELECT	6	input for selection of operating channel
n.c.	7	not connected
OUT2+	8	positive loudspeaker terminal, channel 2
n.c.	9	not connected
GND2	10	ground, channel 2
V <sub>CC2</sub>	11	supply voltage, channel 2
n.c.	12	not connected
OUT2-	13	negative loudspeaker terminal, channel 2
IN2-	14	negative input, channel 2
IN2+	15	positive input, channel 2
IN1+	16	positive input, channel 1
IN1-	17	negative input, channel 1
OUT1-	18	negative loudspeaker terminal, channel 1
n.c.	19	not connected
V <sub>CC1</sub>	20	supply voltage, channel 1

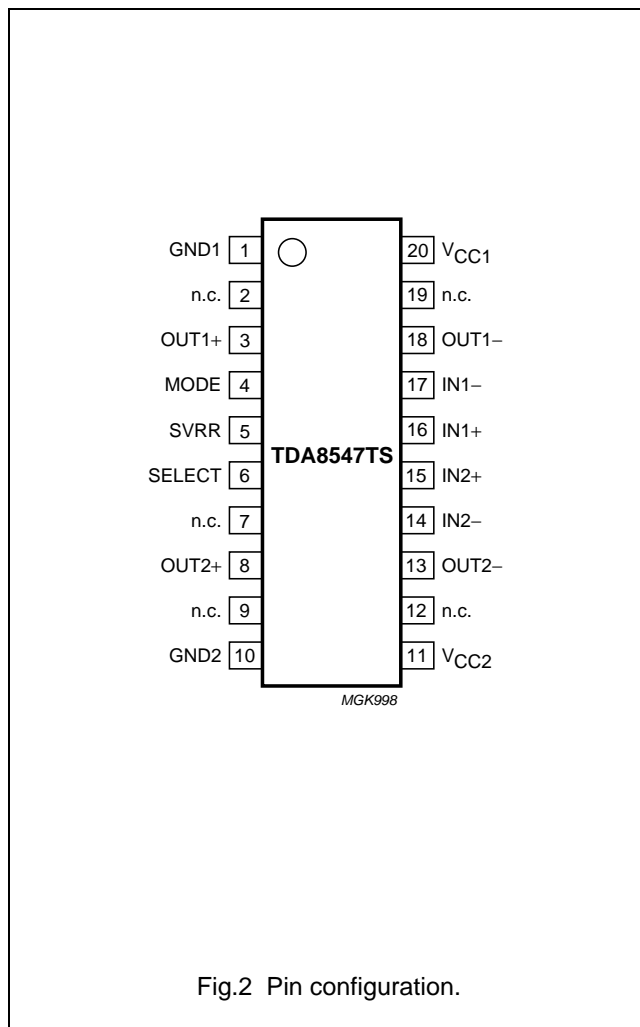

Fig.2 Pin configuration.

### FUNCTIONAL DESCRIPTION

The TDA8547TS is a 2 × 0.7 W BTL audio power amplifier capable of delivering 2 × 0.7 W output power to a 16 Ω load at THD = 10% using a 5 V power supply. Using the MODE pin the device can be switched to standby and mute condition. The device is protected by an internal thermal shutdown protection mechanism. The gain can be set within a range from 6 to 30 dB by external feedback resistors.

#### Power amplifier

The power amplifier is a Bridge-Tied Load (BTL) amplifier with a complementary PNP-NPN output stage. The voltage loss on the positive supply line is the saturation voltage of a PNP power transistor, on the negative side the saturation voltage of a NPN power

transistor. The total voltage loss is <1 V and with a 5 V supply voltage and a 16 Ω loudspeaker an output power of 0.7 W can be delivered, when two channels are operating. If only one channel is operating then an output power of 1.2 W can be delivered (5 V, 8 Ω).

#### MODE pin

The whole device (both channels) is in the standby mode (with a very low current consumption) if the voltage at the MODE pin is >(V<sub>CC</sub> - 0.5 V), or if this pin is floating. At a MODE voltage level of less than 0.5 V the amplifier is fully operational. In the range between 1.5 V and V<sub>CC</sub> - 1.5 V the amplifier is in mute condition. The mute condition is useful to suppress plop noise at the output caused by charging of the input capacitor.

# 2 × 0.7 W BTL audio amplifier with output channel switching

## TDA8547TS

### SELECT pin

If the voltage at the SELECT pin is in the range between 1.5 V and  $V_{CC} - 1.5$  V, or if it is kept floating, then both channels can be operational. If the SELECT pin is set to a LOW voltage or grounded, then only channel 2 can operate and the power amplifier of channel 1 will be in the standby mode. In this case only the loudspeaker at channel 2 can operate and the loudspeaker at channel 1 will be switched off. If the SELECT pin is set to a HIGH level or connected to  $V_{CC}$ , then only channel 1 can operate and the power amplifier of channel 2 will be in the standby mode. In this case only the loudspeaker at channel 1 can operate and the loudspeaker at channel 2 will be switched off. Setting the SELECT pin to a LOW or

a HIGH voltage results in a reduction of quiescent current consumption by a factor of approximately 2.

Switching with the SELECT pin during operating is not pop-free, because the input capacitor of the channel which is coming out of standby needs to be charged first. For pop-free channel selecting the device has first to be set in mute condition with the MODE pin (between 1.5 V and  $V_{CC} - 1.5$  V), then set the SELECT pin to the new level, after a delay set the MODE pin to a LOW level. The delay needed depends on the values of the input capacitor and the feedback resistors. Time needed is approx.  $10 \times C1 \times (R1 + R2)$ , so approximately 0.6 s. for the values in Fig.4.

**Table 1** Control pins MODE and SELECT versus status of output channels  
Voltage levels at control pins at  $V_P = 5$  V; for other supply voltages see Figs. 14 and 15.

CONTROL PIN		STATUS OF OUTPUT CHANNEL		TYP. $I_q$ (mA)
MODE	SELECT	CHANNEL 1	CHANNEL 2	
HIGH <sup>(1)</sup> /NC <sup>(2)</sup>	X <sup>(3)</sup>	standby	standby	0
HVP <sup>(4)</sup>	HVP <sup>(4)</sup> /NC <sup>(2)</sup>	mute	mute	15
LOW <sup>(5)</sup>	HVP <sup>(4)</sup> /NC <sup>(2)</sup>	on	on	15
HVP <sup>(4)</sup> /LOW <sup>(5)</sup>	HIGH <sup>(1)</sup>	mute/on	standby	8
HVP <sup>(4)</sup> /LOW <sup>(5)</sup>	HVP <sup>(4)</sup> /NC <sup>(2)</sup>	mute/on	mute/on	15
HVP <sup>(4)</sup> /LOW <sup>(5)</sup>	LOW <sup>(5)</sup>	standby	mute/on	8

### Notes

1. HIGH =  $V_{pin} > V_{CC} - 0.5$  V.
2. NC = not connected or floating.
3. X = don't care.
4. HVP =  $1.5$  V <  $V_{pin} < V_{CC} - 1.5$  V.
5. LOW =  $V_{pin} < 0.5$  V.

### LIMITING VALUES

In accordance with the Absolute Maximum Rating System (IEC 134).

SYMBOL	PARAMETER	CONDITIONS	MIN.	MAX.	UNIT
$V_{CC}$	supply voltage	operating	-0.3	+18	V
$V_I$	input voltage		-0.3	$V_{CC} + 0.3$	V
$I_{ORM}$	repetitive peak output current		-	1	A
$T_{stg}$	storage temperature		-55	+150	°C
$T_{amb}$	operating ambient temperature		-40	+85	°C
$V_{Psc}$	AC and DC short-circuit safe voltage		-	10	V
$P_{tot}$	power dissipation		-	1.1	W

**2 × 0.7 W BTL audio amplifier with output channel switching**

**TDA8547TS**

**QUALITY SPECIFICATION**

In accordance with “SNW-FQ-611-E”.

**THERMAL CHARACTERISTICS**

SYMBOL	PARAMETER	CONDITIONS	VALUE	UNIT
R <sub>th(j-a)</sub>	thermal resistance from junction to ambient	in free air	110	K/W

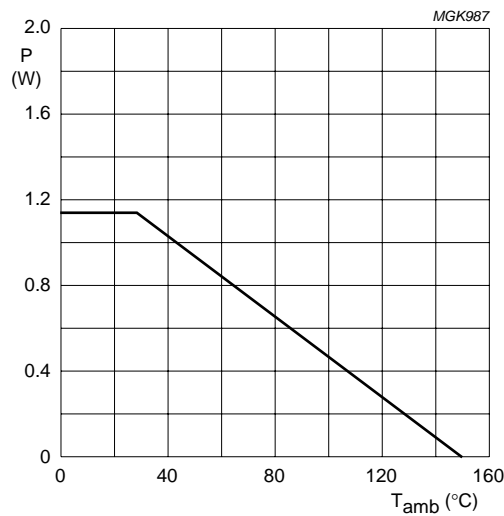

Fig.3 Power derating curve.

**Table 2** Maximum ambient temperature at different conditions

V <sub>CC</sub> (V)	R <sub>L</sub> (Ω)	APPLICATION	P <sub>o</sub> (W) <sup>(1)</sup>	CONTINUOUS SINE WAVE DRIVEN	
				P <sub>max</sub> (W)	T <sub>amb(max)</sub> (°C)
3.3	4	1 channel	1.2	0.58	86
3.3	4	2 channels	2 × 1.2	1.12	27
3.3	8	1 channels	0.6	0.3	117
3.3	8	2 channels	2 × 0.6	0.60	84
5	8	1 channel	1.2	0.67	76
5	8	2 channels	2 × 1.2	1.33	–
5	16	1 channel	0.7	0.35	112
5	16	2 channels	2 × 0.7	0.70	73

**Note**

1. At THD = 10%.

## 2 × 0.7 W BTL audio amplifier with output channel switching

TDA8547TS

### DC CHARACTERISTICS

$V_{CC} = 5\text{ V}$ ;  $T_{amb} = 25\text{ °C}$ ;  $R_L = 8\ \Omega$ ;  $V_{MODE} = 0\text{ V}$ ; gain = 20 dB; measured in BTL application circuit Fig.4; unless otherwise specified.

SYMBOL	PARAMETER	CONDITIONS	MIN.	TYP.	MAX.	UNIT
$V_{CC}$	supply voltage	operating	2.2	5	18	V
$I_q$	quiescent current	BTL 2 channels; note 1	–	15	22	mA
		BTL 1 channel; note 1	–	8	12	mA
$I_{stb}$	standby current	$V_{MODE} = V_{CC}$	–	–	10	$\mu\text{A}$
$V_O$	DC output voltage	note 2	–	2.2	–	V
$ V_{OUT+} - V_{OUT-} $	differential output voltage offset		–	–	50	mV
$I_{IN+}, I_{IN-}$	input bias current		–	–	500	nA
$V_{MODE}$	input voltage MODE pin	operating	0	–	0.5	V
		mute	1.5	–	$V_{CC} - 1.5$	V
		standby	$V_{CC} - 0.5$	–	$V_{CC}$	V
$I_{MODE}$	input current MODE pin	$0\text{ V} < V_{MODE} < V_{CC}$	–	–	20	$\mu\text{A}$
$V_{SELECT}$	input voltage SELECT pin	channel 1 = standby; channel 2 = on	0	–	1	V
		channel 1 = on; channel 2 = standby	$V_{CC} - 1$	–	$V_{CC}$	V
$I_{SELECT}$	input current SELECT pin	$V_{SELECT} = 0\text{ V}$	–	–	100	$\mu\text{A}$

### Notes

1. Measured with  $R_L = \infty$ . With a load connected at the outputs the quiescent current will increase, the maximum of this increase being equal to the DC output offset voltage divided by  $R_L$ .
2. The DC output voltage with respect to ground is approximately  $0.5V_{CC}$ .

## 2 × 0.7 W BTL audio amplifier with output channel switching

TDA8547TS

### AC CHARACTERISTICS

$V_{CC} = 5\text{ V}$ ;  $T_{amb} = 25\text{ °C}$ ;  $R_L = 8\text{ }\Omega$ ;  $f = 1\text{ kHz}$ ;  $V_{MODE} = 0\text{ V}$ ; gain = 20 dB; measured in BTL application circuit Fig.4; unless otherwise specified.

SYMBOL	PARAMETER	CONDITIONS	MIN.	TYP.	MAX.	UNIT
P <sub>o</sub>	output power, one channel	THD = 10%	1	1.2	–	W
		THD = 0.5%	0.6	0.9	–	W
THD	total harmonic distortion	P <sub>o</sub> = 0.4 W	–	0.15	0.3	%
G <sub>v</sub>	closed loop voltage gain	note 1	6	–	30	dB
Z <sub>i</sub>	differential input impedance		–	100	–	k $\Omega$
V <sub>no</sub>	noise output voltage	note 2	–	–	100	$\mu$ V
SVRR	supply voltage ripple rejection	note 3	50	–	–	dB
		note 4	40	–	–	dB
V <sub>o</sub>	output voltage	note 5	–	–	200	$\mu$ V
$\alpha_{CS}$	channel separation	V <sub>SELECT</sub> = 0.5V <sub>CC</sub> ; note 6	40	–	–	dB

### Notes

- Gain of the amplifier is  $2 \times \frac{R_2}{R_1}$  in BTL application circuit Fig.4.
- The noise output voltage is measured at the output in a frequency range from 20 Hz to 20 kHz (unweighted), with a source impedance of  $R_S = 0\text{ }\Omega$  at the input.
- Supply voltage ripple rejection is measured at the output, with a source impedance of  $R_S = 0\text{ }\Omega$  at the input. The ripple voltage is a sine wave with a frequency of 1 kHz and an amplitude of 100 mV (RMS), which is applied to the positive supply rail.
- Supply voltage ripple rejection is measured at the output, with a source impedance of  $R_S = 0\text{ }\Omega$  at the input. The ripple voltage is a sine wave with a frequency between 100 Hz and 20 kHz and an amplitude of 100 mV (RMS), which is applied to the positive supply rail.
- Output voltage in mute position is measured with a 1 V (RMS) input voltage in a bandwidth of 20 Hz to 20 kHz, so including noise.
- Channel separation is measured at the output with a source impedance of  $R_S = 0\text{ }\Omega$  at the input and a frequency of 1 kHz. The output power in the operating channel is set to 0.5 W.



## 2 × 0.7 W BTL audio amplifier with output channel switching

TDA8547TS

### TEST AND APPLICATION INFORMATION

#### Test conditions

Because the application can be either Bridge-Tied Load (BTL) or Single-Ended (SE), the curves of each application are shown separately.

The thermal resistance = 110 K/W for the SSOP20; the maximum sine wave power dissipation for  $T_{amb} = 25\text{ °C}$

$$\text{is: } \frac{150 - 25}{110} = 1.14\text{ W}$$

For  $T_{amb} = 60\text{ °C}$  the maximum total power dissipation is:

$$\frac{150 - 60}{110} = 0.82\text{ W}$$

#### Thermal Design Considerations

The 'measured' thermal resistance of the IC package is highly dependent on the configuration and size of the application board. Data may not be comparable between different Semiconductor manufacturers because the application boards and test methods are not (yet) standardized. Also, the thermal performance of packages for a specific application may be different than presented here, because the configuration of the application boards (copper area!) may be different. NXP Semiconductors uses FR-4 type application boards with 1 oz copper traces with solder coating.

The SSOP package has improved thermal conductivity which reduces the thermal resistance. Using a practical PCB layout (see Fig.24) with wider copper tracks to the corner pins and just under the IC, the thermal resistance from junction to ambient can be reduced to about 80 K/W. For  $T_{amb} = 60\text{ °C}$  the maximum total power dissipation at

$$\text{this PCB layout is: } \frac{150 - 60}{80} = 1.12\text{ W}$$

Please note that this two channel IC is mentioned for application with only one channel active. For that reason the curves for worst case power dissipation are given for the condition of only one of the both channels driven with a 1 kHz sine wave signal.

#### BTL application

$T_{amb} = 25\text{ °C}$  if not specially mentioned,  $V_{CC} = 5\text{ V}$ ,  $f = 1\text{ kHz}$ ,  $R_L = 8\ \Omega$ ,  $G_v = 20\text{ dB}$ , audio band-pass 22 Hz to 22 kHz.

The BTL application circuit is illustrated in Fig.4.

The quiescent current has been measured without any load impedance and both channels driven. When one channel is active the quiescent current will be halved. The total harmonic distortion as a function of frequency was measured using a low-pass filter of 80 kHz. The value of capacitor C3 influences the behaviour of the SVRR at low frequencies: increasing the value of C3 increases the performance of the SVRR. The figure of the MODE voltage ( $V_{MODE}$ ) as a function of the supply voltage shows three areas; operating, mute and standby. It shows, that the DC-switching levels of the mute and standby respectively depend on the supply voltage level. The figure of the SELECT voltage ( $V_{SELECT}$ ) as a function of the supply voltage shows the voltage levels for switching the channels in the active, mute or standby mode.

#### SE application

$T_{amb} = 25\text{ °C}$  if not specially mentioned,  $V_{CC} = 7.5\text{ V}$ ,  $f = 1\text{ kHz}$ ,  $R_L = 4\ \Omega$ ,  $G_v = 20\text{ dB}$ , audio band-pass 22 Hz to 22 kHz.

The SE application circuit is illustrated in Fig.16.

Increasing the value of electrolytic capacitor C3 will result in a better channel separation. Because the positive output is not designed for high output current ( $2 \times I_o$ ) at low load impedance ( $\leq 16\ \Omega$ ), the SE application with output capacitors connected to ground is advised. The capacitor value of C6/C7 in combination with the load impedance determines the low frequency behaviour. The THD as a function of frequency was measured using a low-pass filter of 80 kHz. The value of capacitor C3 influences the behaviour of the SVRR at low frequencies: increasing the value of C3 increases the performance of the SVRR.

#### General remark

The frequency characteristic can be adapted by connecting a small capacitor across the feedback resistor. To improve the immunity to HF radiation in radio circuit applications, a small capacitor can be connected in parallel with the feedback resistor (56 k $\Omega$ ); this creates a low-pass filter.

# 2 × 0.7 W BTL audio amplifier with output channel switching

## TDA8547TS

### BTL APPLICATION

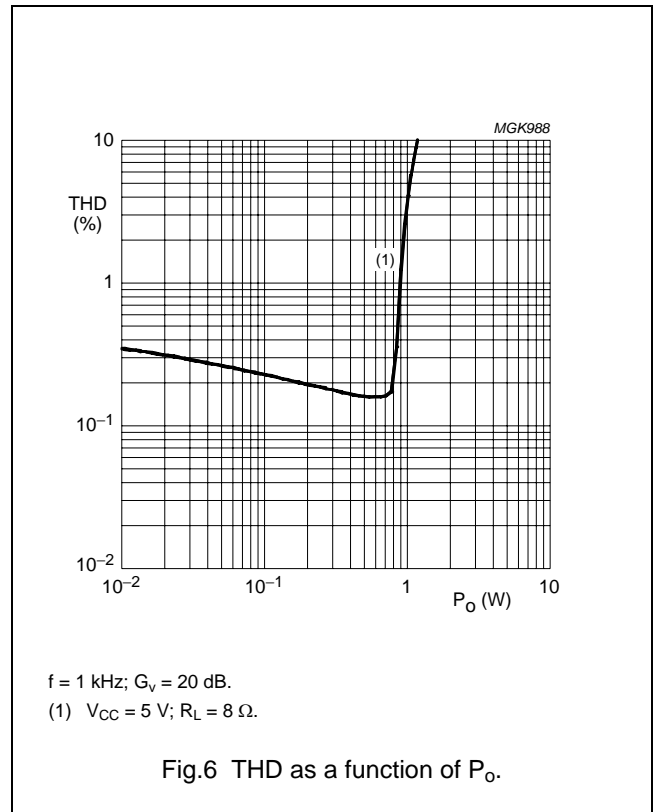
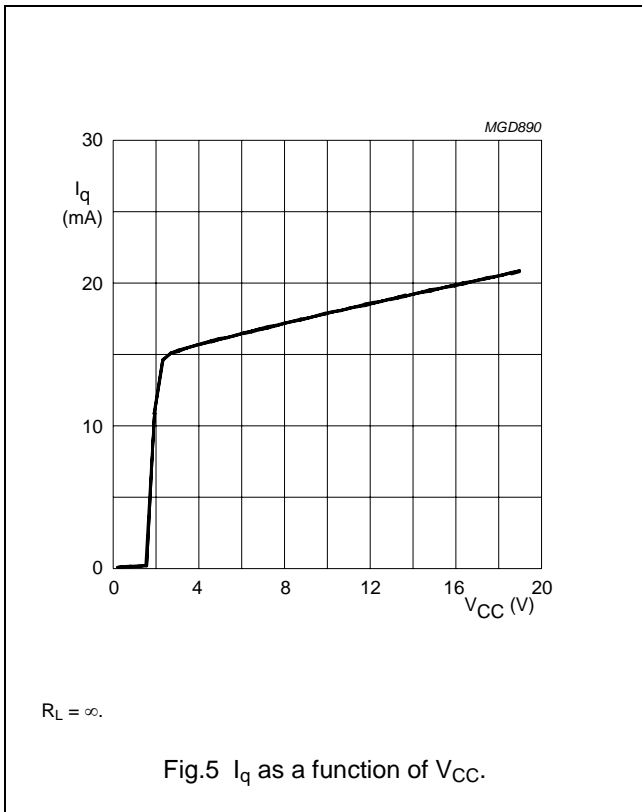
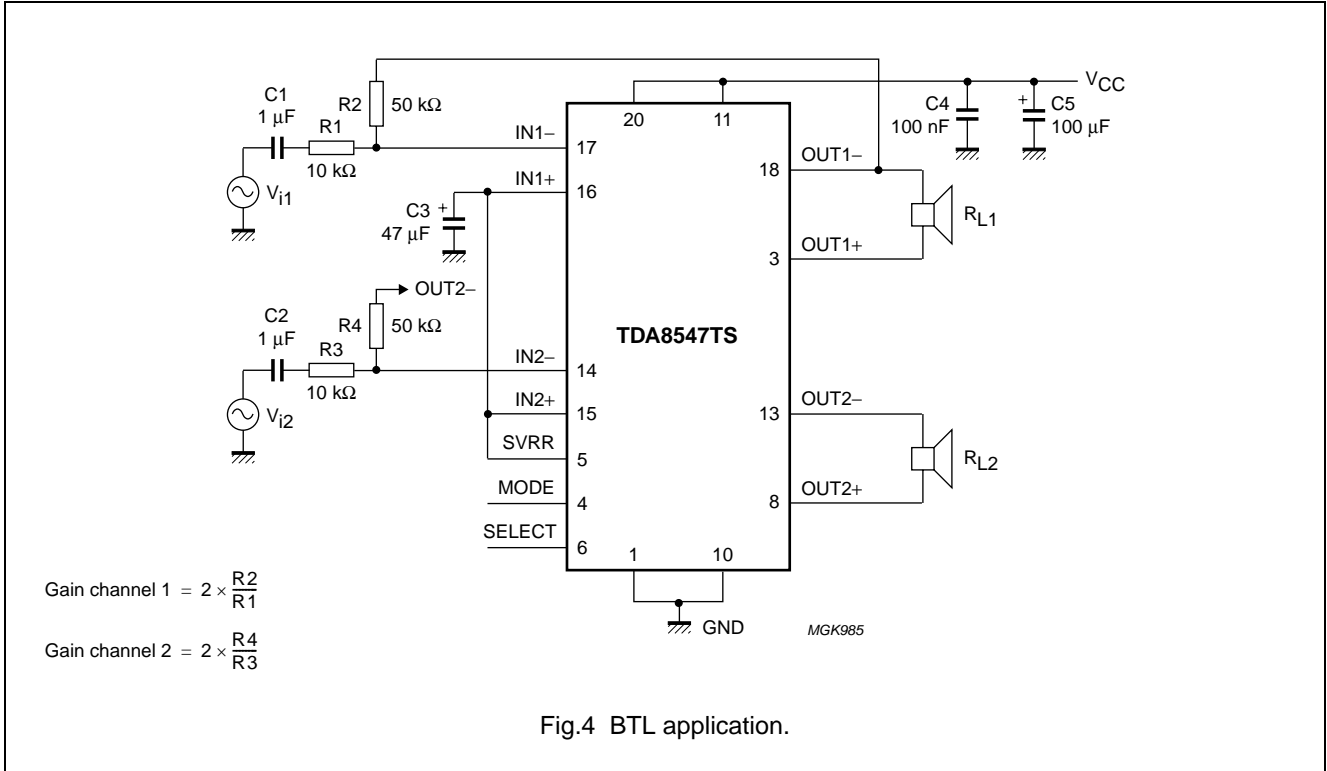

2 × 0.7 W BTL audio amplifier with output channel switching

TDA8547TS

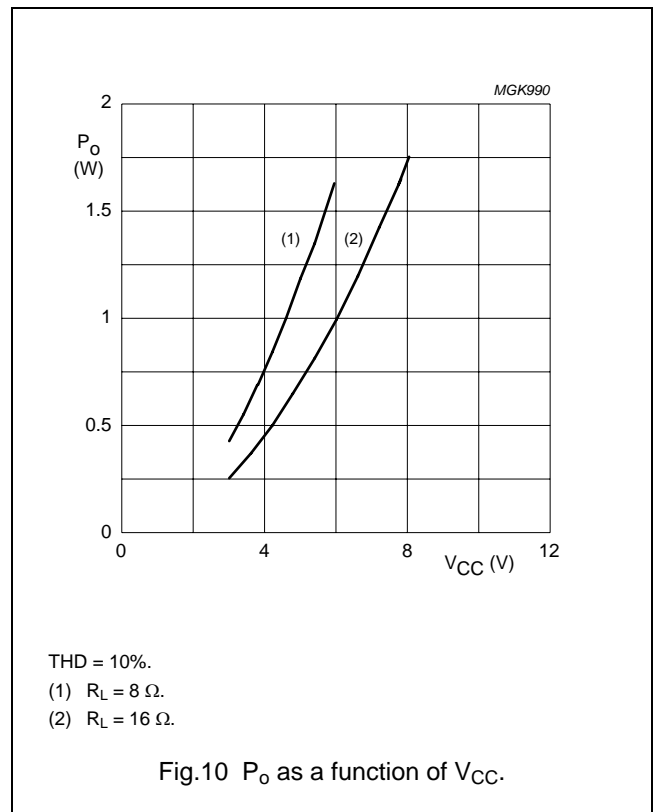
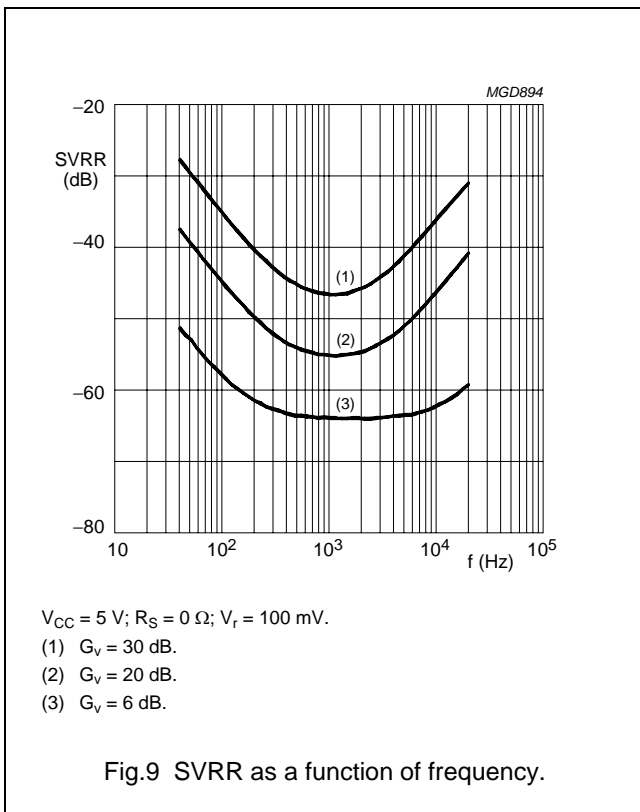
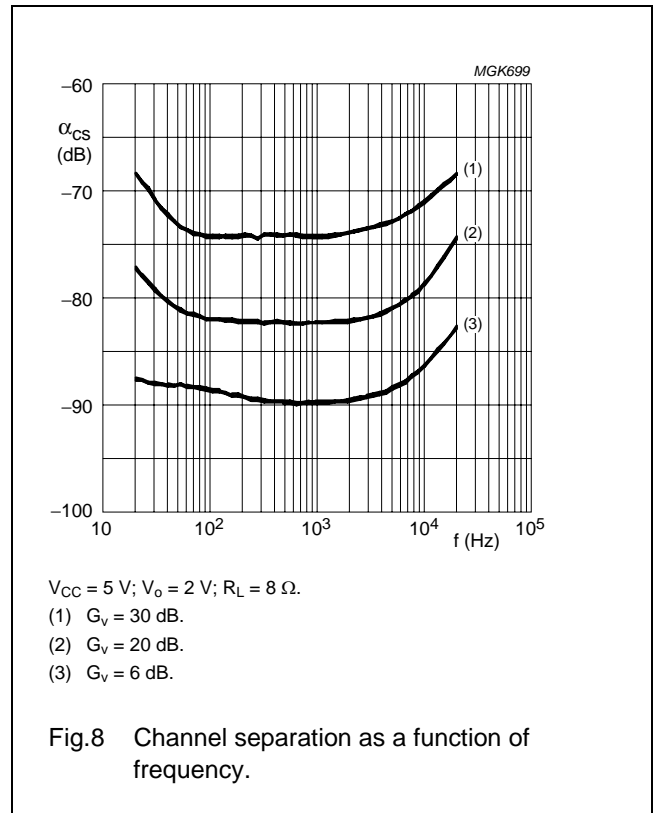
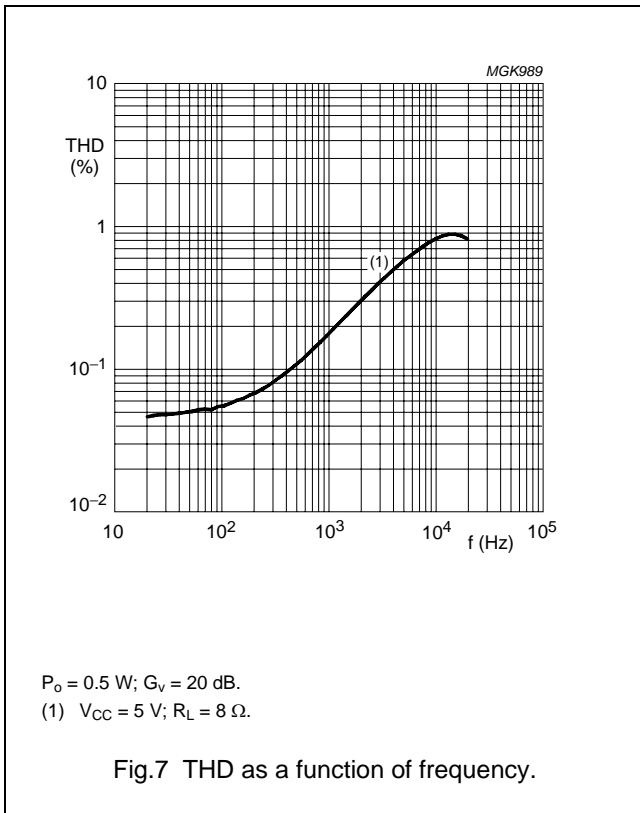

2 × 0.7 W BTL audio amplifier with output channel switching

TDA8547TS

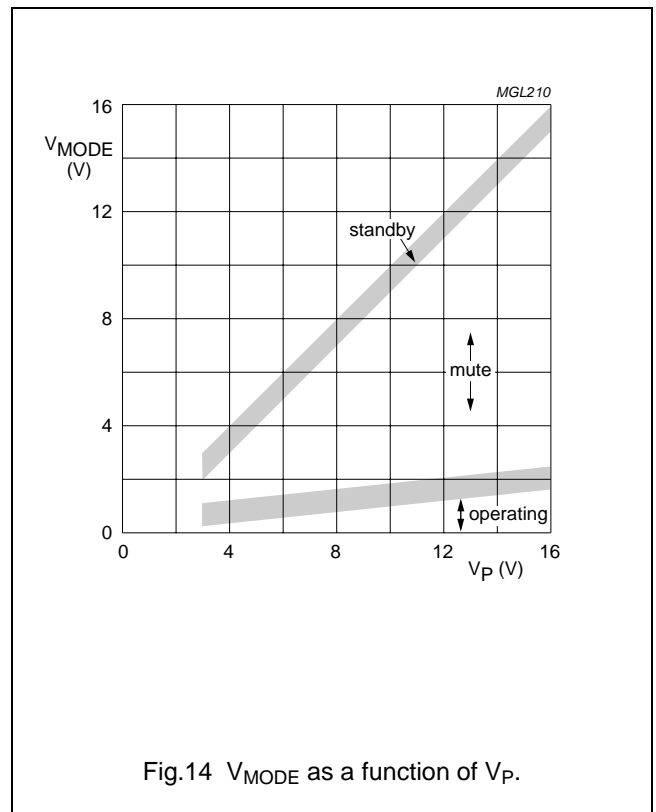
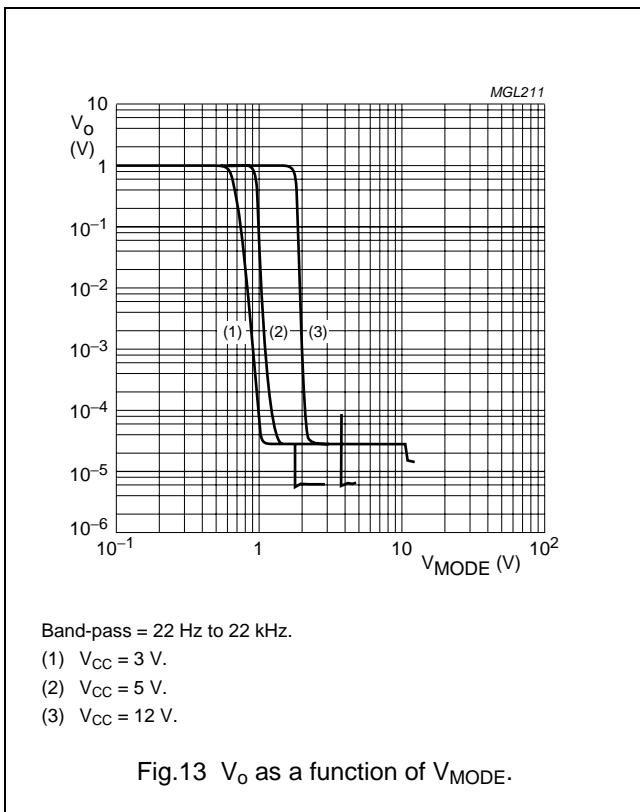
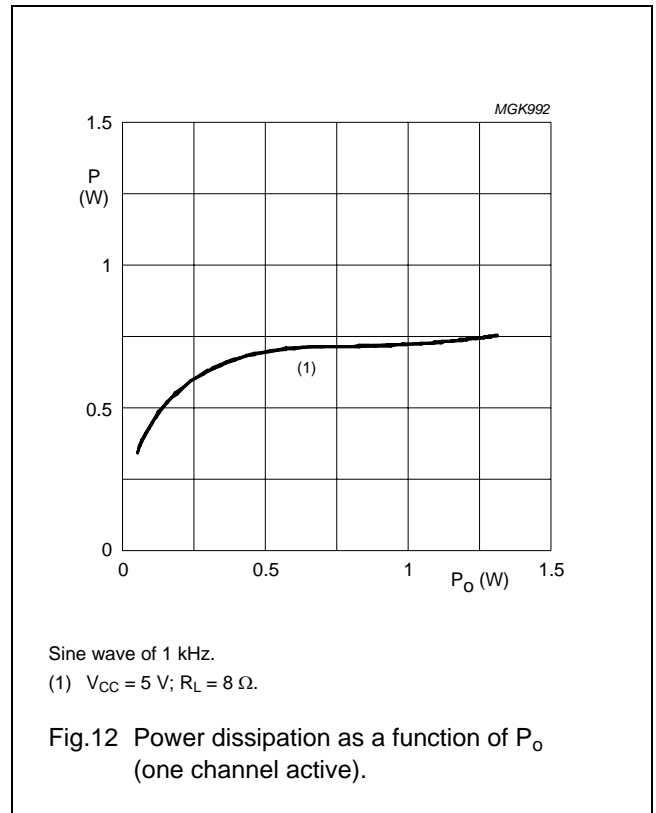
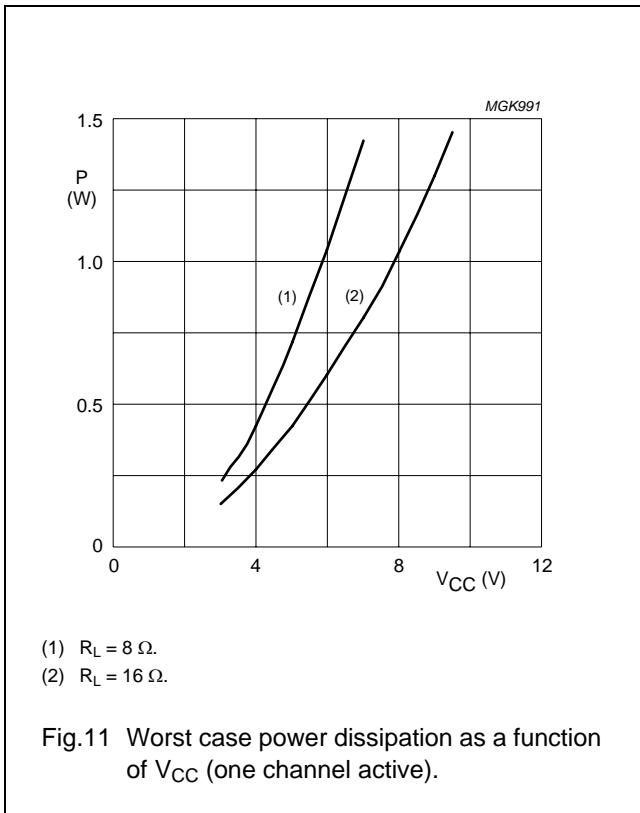

2 × 0.7 W BTL audio amplifier with output channel switching

TDA8547TS

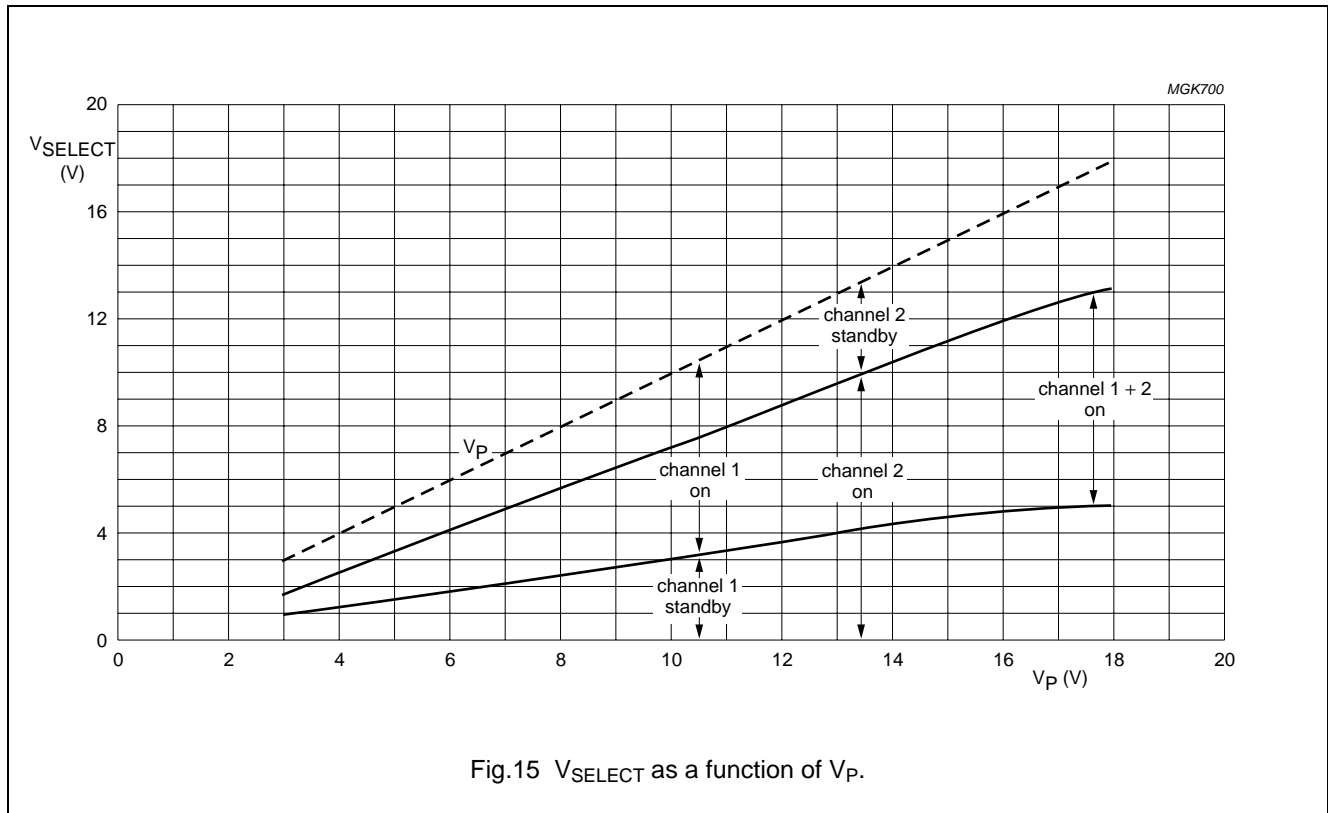

Fig.15  $V_{SELECT}$  as a function of  $V_P$ .

SE APPLICATION

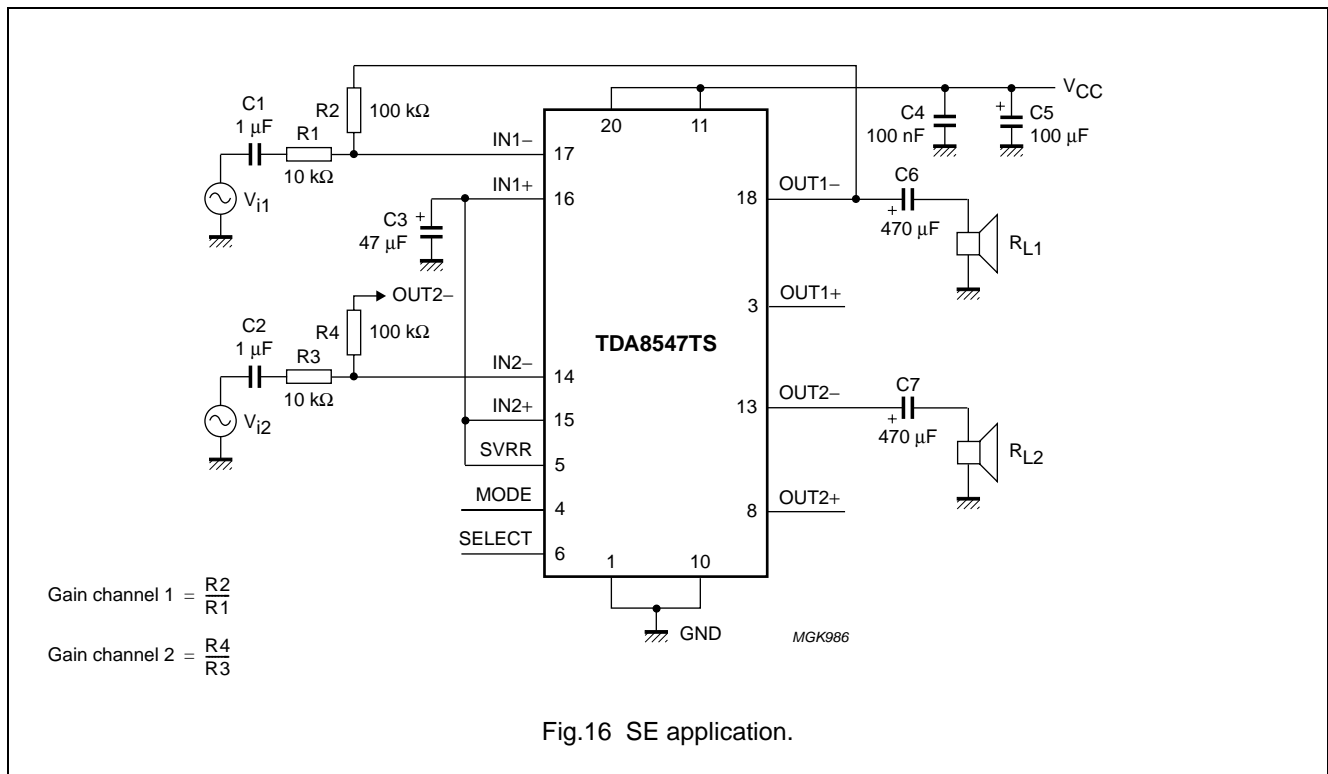
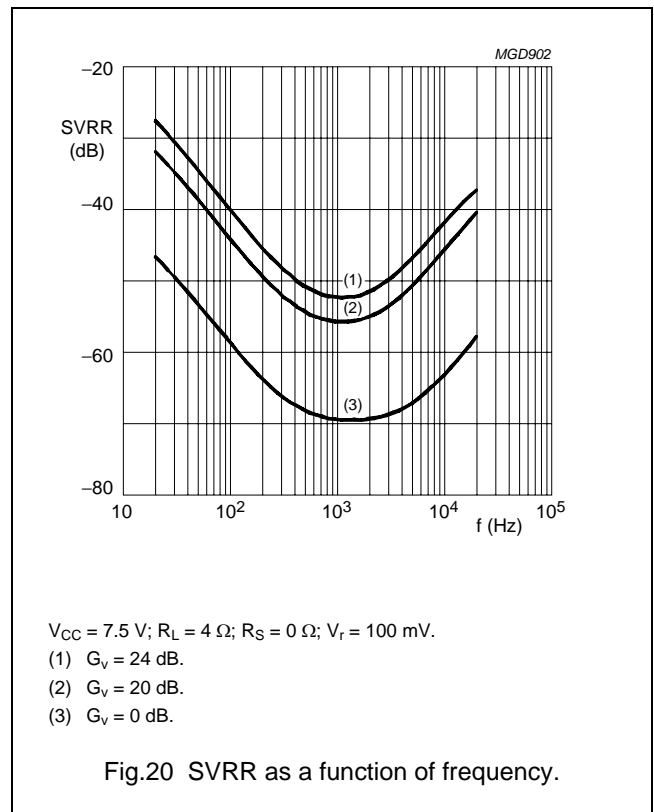
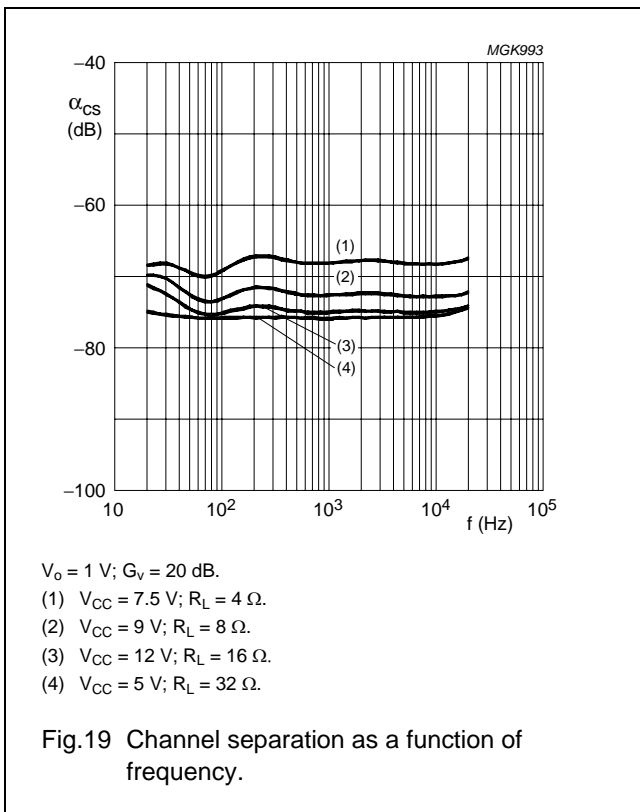
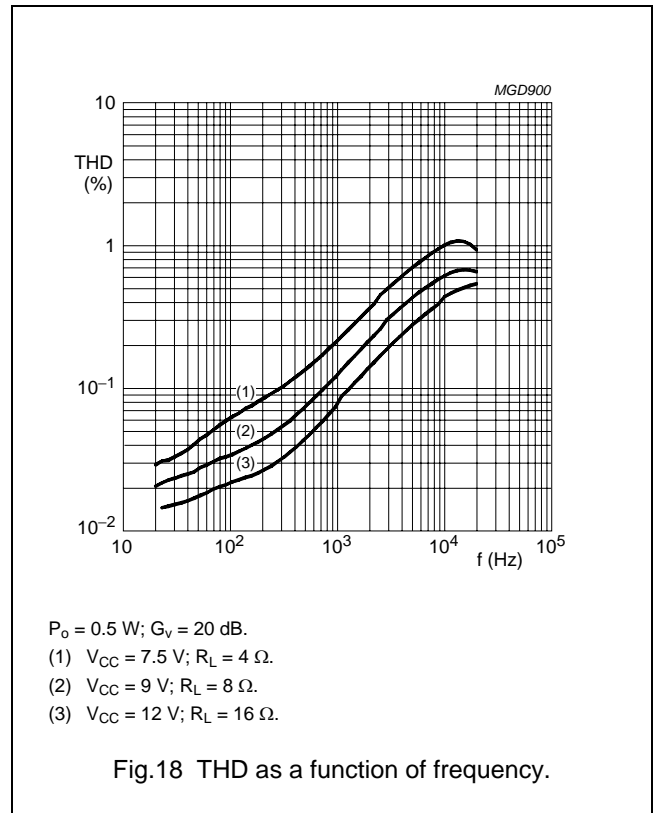
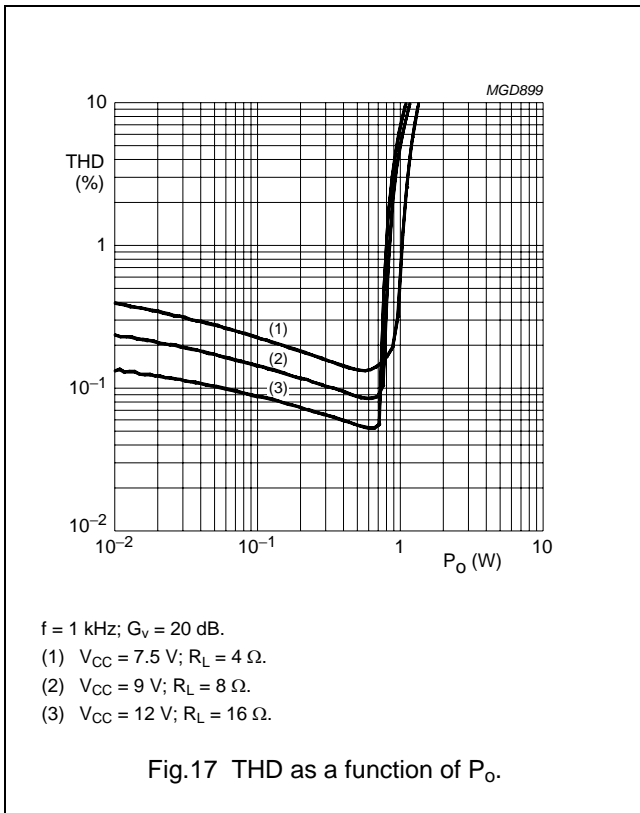

Fig.16 SE application.

2 × 0.7 W BTL audio amplifier with output channel switching

TDA8547TS



2 × 0.7 W BTL audio amplifier with output channel switching

TDA8547TS

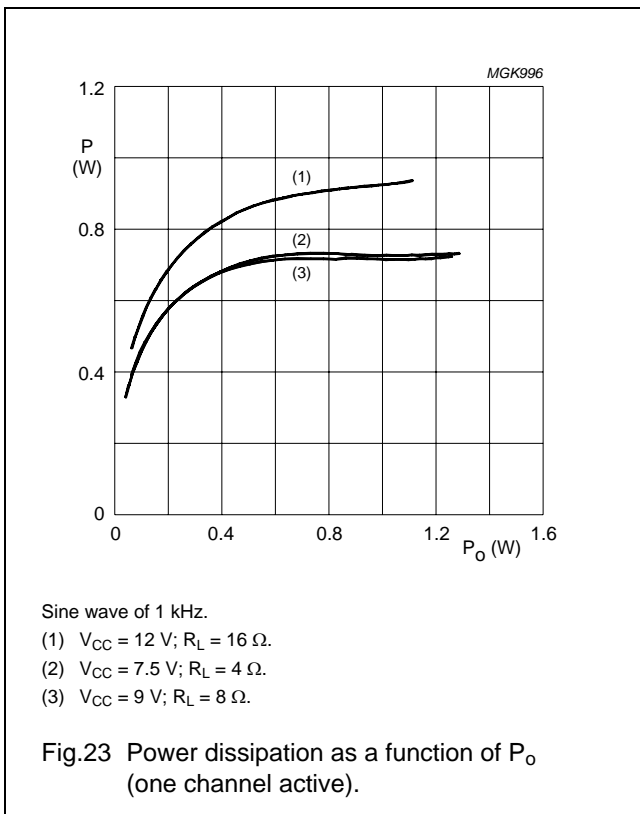
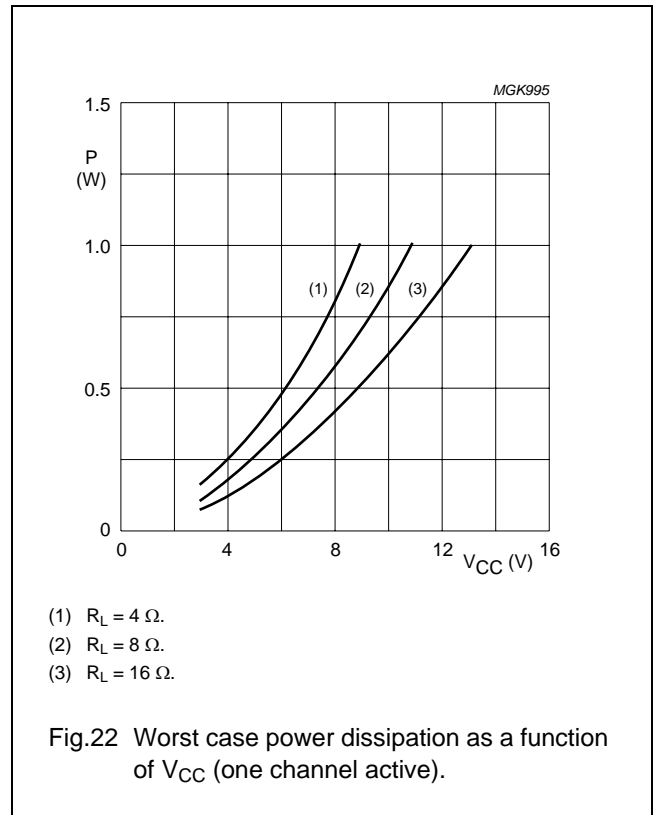
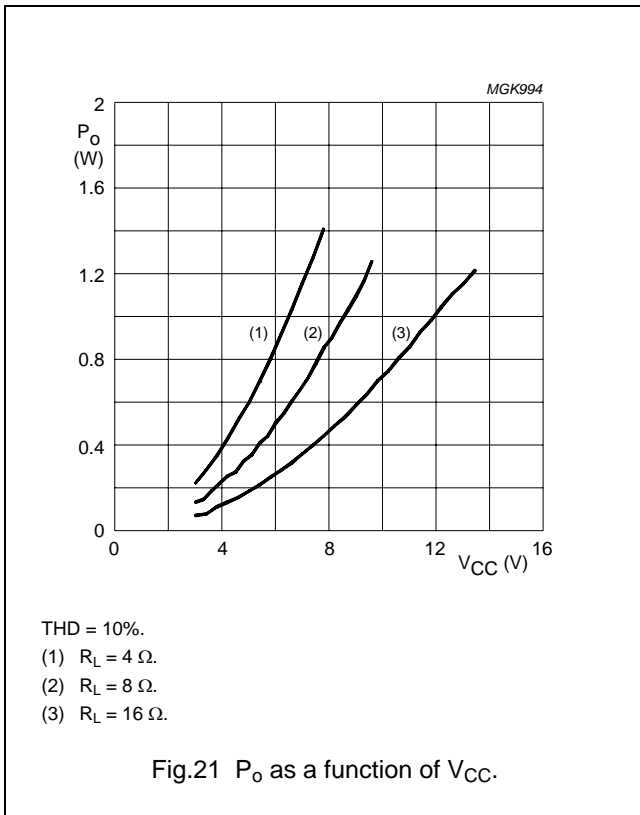

# 2 × 0.7 W BTL audio amplifier with output channel switching

## TDA8547TS

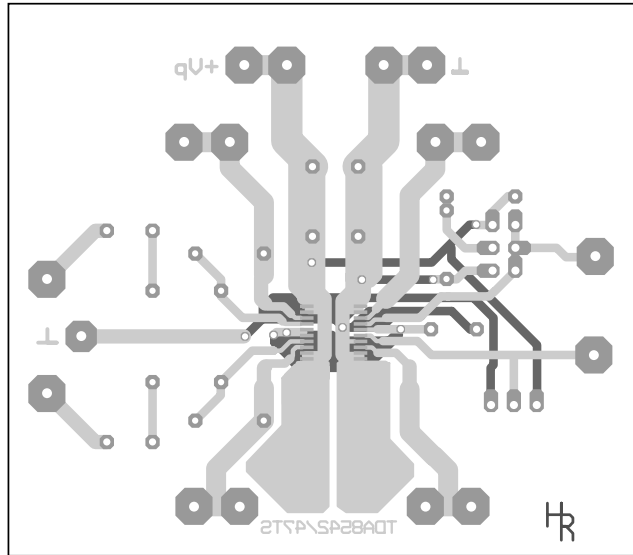

a. Top view copper layout.

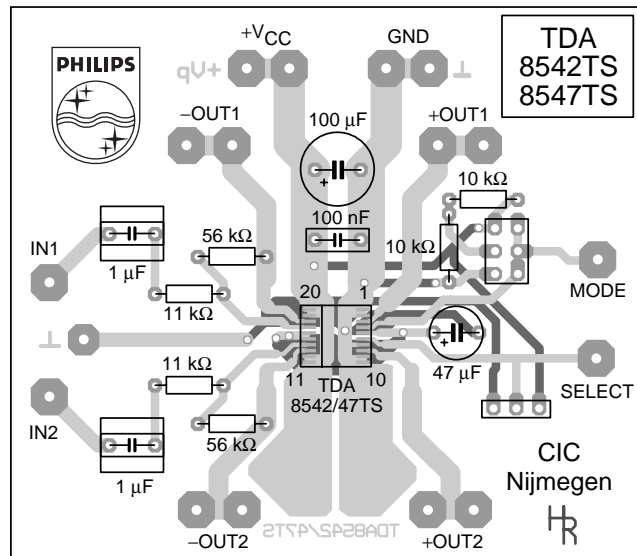

b. Top view components layout.

Fig.24 Printed-circuit board layout (BTL).



2 × 0.7 W BTL audio amplifier with output channel switching

TDA8547TS

PACKAGE OUTLINE

SSOP20: plastic shrink small outline package; 20 leads; body width 4.4 mm

SOT266-1

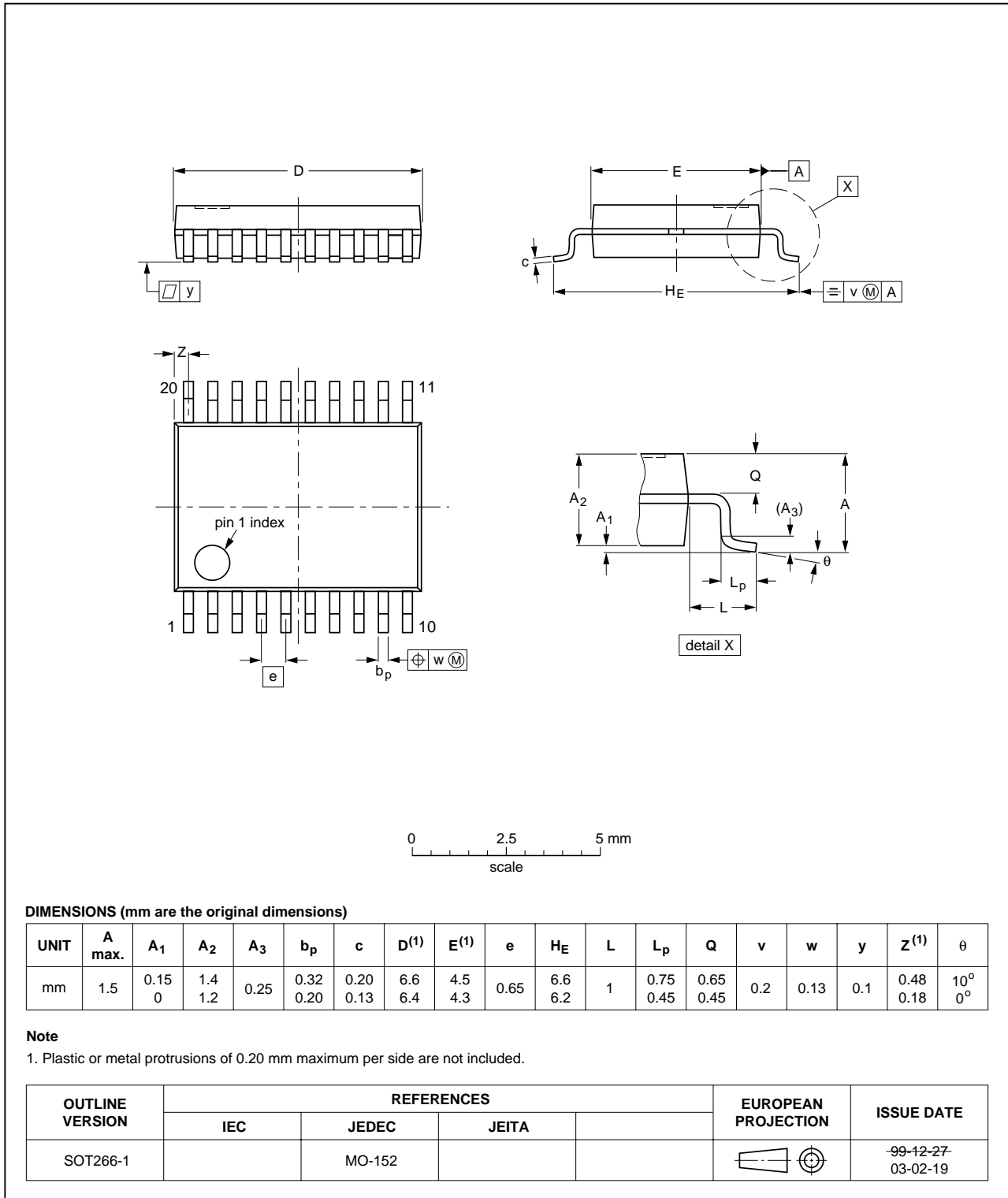

## 2 × 0.7 W BTL audio amplifier with output channel switching

TDA8547TS

### SOLDERING

#### Introduction

There is no soldering method that is ideal for all IC packages. Wave soldering is often preferred when through-hole and surface mounted components are mixed on one printed-circuit board. However, wave soldering is not always suitable for surface mounted ICs, or for printed-circuits with high population densities. In these situations reflow soldering is often used.

This text gives a very brief insight to a complex technology. A more in-depth account of soldering ICs can be found in our "IC Package Databook" (order code 9398 652 90011).

#### DIP

##### SOLDERING BY DIPPING OR BY WAVE

The maximum permissible temperature of the solder is 260 °C; solder at this temperature must not be in contact with the joint for more than 5 seconds. The total contact time of successive solder waves must not exceed 5 seconds.

The device may be mounted up to the seating plane, but the temperature of the plastic body must not exceed the specified maximum storage temperature ( $T_{stg\ max}$ ). If the printed-circuit board has been pre-heated, forced cooling may be necessary immediately after soldering to keep the temperature within the permissible limit.

##### REPAIRING SOLDERED JOINTS

Apply a low voltage soldering iron (less than 24 V) to the lead(s) of the package, below the seating plane or not more than 2 mm above it. If the temperature of the soldering iron bit is less than 300 °C it may remain in contact for up to 10 seconds. If the bit temperature is between 300 and 400 °C, contact may be up to 5 seconds.

#### SO

##### REFLOW SOLDERING

Reflow soldering techniques are suitable for all SO packages.

Reflow soldering requires solder paste (a suspension of fine solder particles, flux and binding agent) to be applied to the printed-circuit board by screen printing, stencilling or pressure-syringe dispensing before package placement.

Several techniques exist for reflowing; for example, thermal conduction by heated belt. Dwell times vary between 50 and 300 seconds depending on heating method. Typical reflow temperatures range from 215 to 250 °C.

Preheating is necessary to dry the paste and evaporate the binding agent. Preheating duration: 45 minutes at 45 °C.

##### WAVE SOLDERING

Wave soldering techniques can be used for all SO packages if the following conditions are observed:

- A double-wave (a turbulent wave with high upward pressure followed by a smooth laminar wave) soldering technique should be used.
- The longitudinal axis of the package footprint must be parallel to the solder flow.
- The package footprint must incorporate solder thieves at the downstream end.

During placement and before soldering, the package must be fixed with a droplet of adhesive. The adhesive can be applied by screen printing, pin transfer or syringe dispensing. The package can be soldered after the adhesive is cured.

Maximum permissible solder temperature is 260 °C, and maximum duration of package immersion in solder is 10 seconds, if cooled to less than 150 °C within 6 seconds. Typical dwell time is 4 seconds at 250 °C.

A mildly-activated flux will eliminate the need for removal of corrosive residues in most applications.

##### REPAIRING SOLDERED JOINTS

Fix the component by first soldering two diagonally-opposite end leads. Use only a low voltage soldering iron (less than 24 V) applied to the flat part of the lead. Contact time must be limited to 10 seconds at up to 300 °C. When using a dedicated tool, all other leads can be soldered in one operation within 2 to 5 seconds between 270 and 320 °C.

## 2 × 0.7 W BTL audio amplifier with output channel switching

TDA8547TS

### DATA SHEET STATUS

DOCUMENT STATUS <sup>(1)</sup>	PRODUCT STATUS <sup>(2)</sup>	DEFINITION
Objective data sheet	Development	This document contains data from the objective specification for product development.
Preliminary data sheet	Qualification	This document contains data from the preliminary specification.
Product data sheet	Production	This document contains the product specification.

### Notes

1. Please consult the most recently issued document before initiating or completing a design.
2. The product status of device(s) described in this document may have changed since this document was published and may differ in case of multiple devices. The latest product status information is available on the Internet at URL <http://www.nxp.com>.

### DISCLAIMERS

**Limited warranty and liability** — Information in this document is believed to be accurate and reliable. However, NXP Semiconductors does not give any representations or warranties, expressed or implied, as to the accuracy or completeness of such information and shall have no liability for the consequences of use of such information.

In no event shall NXP Semiconductors be liable for any indirect, incidental, punitive, special or consequential damages (including - without limitation - lost profits, lost savings, business interruption, costs related to the removal or replacement of any products or rework charges) whether or not such damages are based on tort (including negligence), warranty, breach of contract or any other legal theory.

Notwithstanding any damages that customer might incur for any reason whatsoever, NXP Semiconductors' aggregate and cumulative liability towards customer for the products described herein shall be limited in accordance with the *Terms and conditions of commercial sale* of NXP Semiconductors.

**Right to make changes** — NXP Semiconductors reserves the right to make changes to information published in this document, including without limitation specifications and product descriptions, at any time and without notice. This document supersedes and replaces all information supplied prior to the publication hereof.

**Suitability for use** — NXP Semiconductors products are not designed, authorized or warranted to be suitable for use in life support, life-critical or safety-critical systems or equipment, nor in applications where failure or malfunction of an NXP Semiconductors product can reasonably be expected to result in personal injury, death or severe

property or environmental damage. NXP Semiconductors accepts no liability for inclusion and/or use of NXP Semiconductors products in such equipment or applications and therefore such inclusion and/or use is at the customer's own risk.

**Applications** — Applications that are described herein for any of these products are for illustrative purposes only. NXP Semiconductors makes no representation or warranty that such applications will be suitable for the specified use without further testing or modification.

Customers are responsible for the design and operation of their applications and products using NXP Semiconductors products, and NXP Semiconductors accepts no liability for any assistance with applications or customer product design. It is customer's sole responsibility to determine whether the NXP Semiconductors product is suitable and fit for the customer's applications and products planned, as well as for the planned application and use of customer's third party customer(s). Customers should provide appropriate design and operating safeguards to minimize the risks associated with their applications and products.

NXP Semiconductors does not accept any liability related to any default, damage, costs or problem which is based on any weakness or default in the customer's applications or products, or the application or use by customer's third party customer(s). Customer is responsible for doing all necessary testing for the customer's applications and products using NXP Semiconductors products in order to avoid a default of the applications and the products or of the application or use by customer's third party customer(s). NXP does not accept any liability in this respect.

---

## 2 × 0.7 W BTL audio amplifier with output channel switching

---

TDA8547TS

**Limiting values** — Stress above one or more limiting values (as defined in the Absolute Maximum Ratings System of IEC 60134) will cause permanent damage to the device. Limiting values are stress ratings only and (proper) operation of the device at these or any other conditions above those given in the Recommended operating conditions section (if present) or the Characteristics sections of this document is not warranted. Constant or repeated exposure to limiting values will permanently and irreversibly affect the quality and reliability of the device.

**Terms and conditions of commercial sale** — NXP Semiconductors products are sold subject to the general terms and conditions of commercial sale, as published at <http://www.nxp.com/profile/terms>, unless otherwise agreed in a valid written individual agreement. In case an individual agreement is concluded only the terms and conditions of the respective agreement shall apply. NXP Semiconductors hereby expressly objects to applying the customer's general terms and conditions with regard to the purchase of NXP Semiconductors products by customer.

**No offer to sell or license** — Nothing in this document may be interpreted or construed as an offer to sell products that is open for acceptance or the grant, conveyance or implication of any license under any copyrights, patents or other industrial or intellectual property rights.

**Export control** — This document as well as the item(s) described herein may be subject to export control regulations. Export might require a prior authorization from national authorities.

**Quick reference data** — The Quick reference data is an extract of the product data given in the Limiting values and Characteristics sections of this document, and as such is not complete, exhaustive or legally binding.

**Non-automotive qualified products** — Unless this data sheet expressly states that this specific NXP Semiconductors product is automotive qualified, the product is not suitable for automotive use. It is neither qualified nor tested in accordance with automotive testing or application requirements. NXP Semiconductors accepts no liability for inclusion and/or use of non-automotive qualified products in automotive equipment or applications.

In the event that customer uses the product for design-in and use in automotive applications to automotive specifications and standards, customer (a) shall use the product without NXP Semiconductors' warranty of the product for such automotive applications, use and specifications, and (b) whenever customer uses the product for automotive applications beyond NXP Semiconductors' specifications such use shall be solely at customer's own risk, and (c) customer fully indemnifies NXP Semiconductors for any liability, damages or failed product claims resulting from customer design and use of the product for automotive applications beyond NXP Semiconductors' standard warranty and NXP Semiconductors' product specifications.

# **NXP Semiconductors**

***provides High Performance Mixed Signal and Standard Product solutions that leverage its leading RF, Analog, Power Management, Interface, Security and Digital Processing expertise***

## **Customer notification**

This data sheet was changed to reflect the new company name NXP Semiconductors, including new legal definitions and disclaimers. No changes were made to the technical content, except for package outline drawings which were updated to the latest version.

## **Contact information**

For additional information please visit: <http://www.nxp.com>

For sales offices addresses send e-mail to: [salesaddresses@nxp.com](mailto:salesaddresses@nxp.com)

© NXP B.V. 2010

All rights are reserved. Reproduction in whole or in part is prohibited without the prior written consent of the copyright owner.

The information presented in this document does not form part of any quotation or contract, is believed to be accurate and reliable and may be changed without notice. No liability will be accepted by the publisher for any consequence of its use. Publication thereof does not convey nor imply any license under patent- or other industrial or intellectual property rights.

Printed in The Netherlands

545102/00/02/pp21

Date of release: 1998 Apr 01

Document order number: 9397 750 03347