



**INTERFACE CIRCUIT - RELAY AND LAMP-DRIVER**

- OPEN GROUND PROTECTION (TDE1747)
- HIGH OUTPUT CURRENT
- ADJUSTABLE SHORT-CIRCUIT PROTECTION TO GROUND
- THERMAL PROTECTION WITH HYSTERESIS TO AVOID THE INTERMEDIATE OUTPUT LEVELS
- LARGE SUPPLY VOLTAGE RANGE : + 10 V TO + 45 V
- SHORT-CIRCUIT PROTECTION TO V<sub>cc</sub>

**DESCRIPTION**

The TDE1647, TDE1747, TDE1607, TDF1607 are monolithic designed for high current and high voltage applications, specifically to drive lamps, relays stepping motors.

These devices are essentially blow-out proof. Current limiting is available to limit the peak output current to safe values, the adjustment only requires one external resistor. In addition, thermal shut down is provided to keep the I.C. from overheating. If internal dissipation becomes too great, the driver will shut down to prevent excessive heating. Moreover, TDE1747 has an open ground protection. The output is also protected from short-circuits with the positive power supply.

The device operates over a wide range of supply voltages from standard  $\pm 15$  V operational amplifier supplies down to the single + 12 V or + 24 used for industrial electronic systems.



**MINIDIP/2**  
(DP)

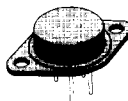

**METAL CAN**  
(CM)

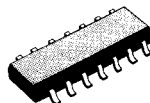

**SO-14J**

**ORDER CODES**

Part Number	Temperature Range	Package		
		CM	DP	FP
<b>TDE1647</b>	- 25 °C to + 85 °C	•	•	
<b>TDE1747</b>	- 25 °C to + 85 °C	•	•	•
<b>TDE1607</b>	- 25 °C to + 85 °C	•	•	
<b>TDF1647A</b>	- 25 °C to + 85 °C	•		
<b>TDF1607</b>	- 40 °C to + 85 °C		•	

**Example :** TDE1647DP - TDE1607CM

**PIN CONNECTION** (top view)

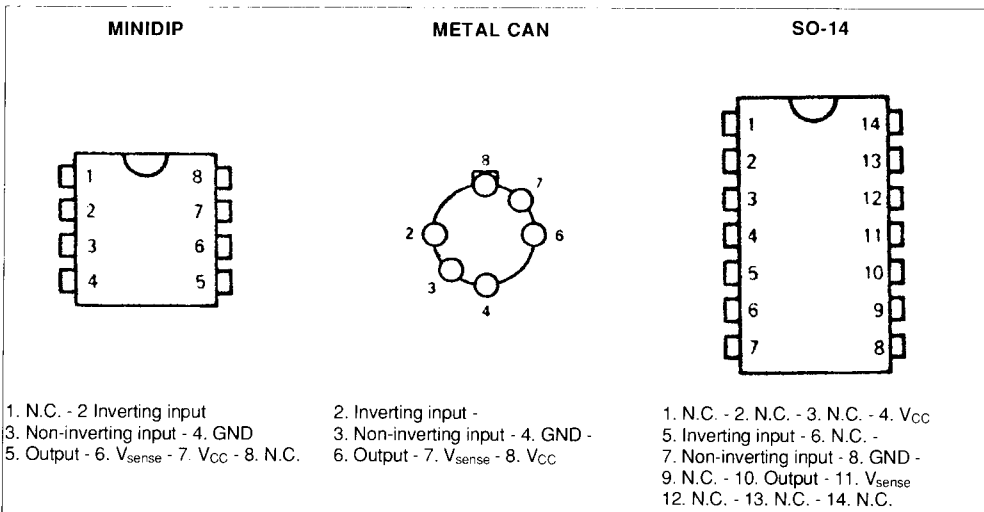

**ABSOLUTE MAXIMUM RATINGS**

Symbol	Parameter	TDE1647/A TDE1747	TDE1607	Unit
$V_{CC}$	Supply Voltage	50 *	36	V
$V_{ID}$	Differential Input Voltage	50	36	V
$V_i$	Input Voltage	50	36	V
$I_O$	Output Current	1000	500	mA
$P_{tot}$	Power Dissipation ( $T_{amb} = + 25\text{ }^\circ\text{C}$ )	Internally Limited		W
$T_{stg}$	Storage Temperature Range	- 65 to + 150		$^\circ\text{C}$
$T_{oper}$	Operating Ambient Temperature Range TDE TDF	- 25 to + 85 - 40 to + 85		$^\circ\text{C}$

(\*)  $V_{CC} = + 60\text{ V}$ ,  $t \leq 10\text{ ms}$  for TDE 1647A.

**THERMAL CHARACTERISTICS**

Symbol	Parameter	Value	Unit	
$R_{th(j-c)}$	Maximum Junction-case Thermal Resistance	METAL CAN MINIDIP	45 50	$^\circ\text{C/W}$
$R_{th(j-a)}$	Maximum Junction-ambient Thermal Resistance	METAL CAN MINIDIP	185 120	$^\circ\text{C/W}$
$R_{th}$	Junction-ceramic Substrate (case glued to substrate)	SO14	90	$^\circ\text{C/W}$
$R_{th}$	Junction-ceramic Substrate (case glued to substrate, substrate temperature maintained constant)	SO14	65	$^\circ\text{C/W}$

**SCHEMATIC DIAGRAM**

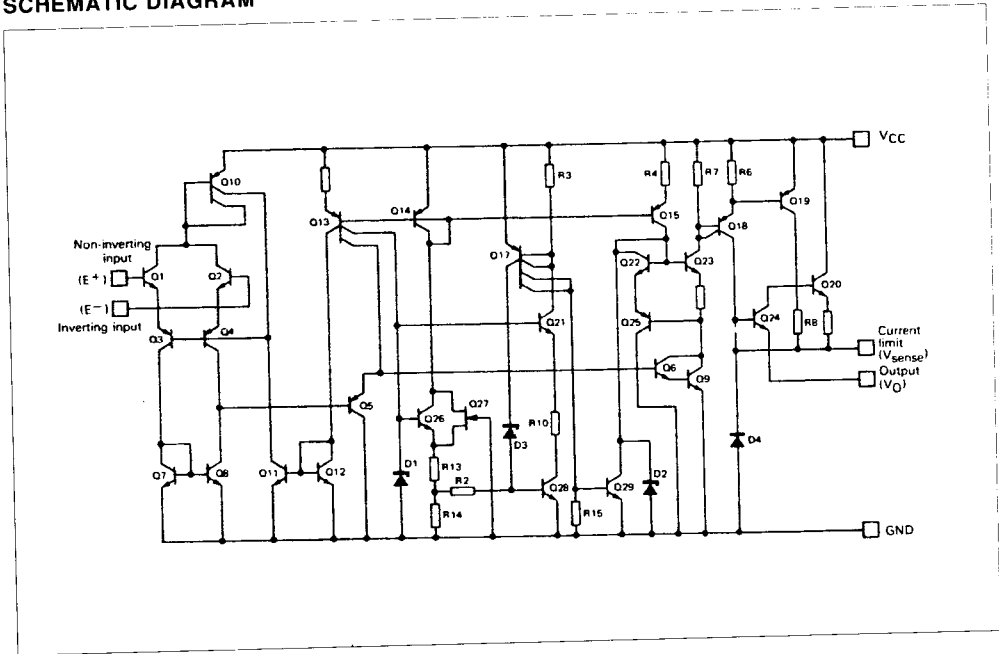

**SIMPLIFIED CIRCUIT**

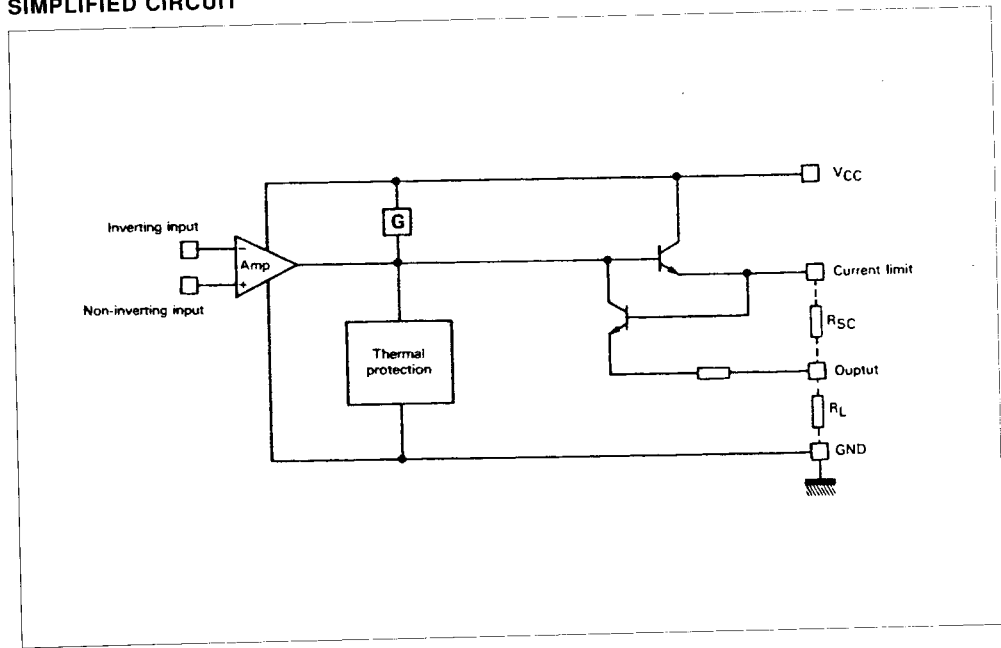

**ELECTRICAL CHARACTERISTICS** (note 1)  $T_j \leq +150\text{ }^\circ\text{C}$

**TDE1647, A TDE1747** :  $-25\text{ }^\circ\text{C} \leq T_{amb} \leq +85\text{ }^\circ\text{C}$ ,  $+8\text{ V} \leq V_{CC} \leq +45\text{ V}$ ,  $I_O = 300\text{ mA}$

**TDE1607DP** :  $-25\text{ }^\circ\text{C} \leq T_{amb} \leq +85\text{ }^\circ\text{C}$ ,  $+8\text{ V} \leq V_{CC} \leq +30\text{ V}$ ,  $I_O = 150\text{ mA}$

**TDE1607CM** :  $-25\text{ }^\circ\text{C} \leq T_{amb} \leq +85\text{ }^\circ\text{C}$ ,  $+8\text{ V} \leq V_{CC} \leq +30\text{ V}$ ,  $I_O = 300\text{ mA}$

**TDE1607DP** :  $-40\text{ }^\circ\text{C} \leq T_{amb} \leq +85\text{ }^\circ\text{C}$ ,  $+8\text{ V} \leq V_{CC} \leq +30\text{ V}$ ,  $I_O = 150\text{ mA}$

Symbol	Parameter	TDE1647, A TDE1747			TDF1607DP TDE1607CM(a) TDE1607DP, FP			Unit
		Min.	Typ.	Max.	Min.	Typ.	Max.	
$V_{IO}$	Input Offset Voltage - (note 2)	-	2	50	-	2	50	mV
$I_{IB}$	Input Bias Current	-	0.1	1.5	-	0.1	1.5	$\mu\text{A}$
$I_{CC}$	Supply Current ( $V_{CC} = +24\text{ V}$ , $I_O = 0$ )							
	High Level	-	4	6	-	4	6	mA
	Low Level	-	2	4	-	2	4	
$V_{I(max)}$	Common-mode Input Voltage Range	2	-	$V_{CC}-2$	2	-	$V_{CC}-2$	V
$I_{SC}$	Short-circuit Current Limit ( $T_{amb} = +25\text{ }^\circ\text{C}$ , $V_{CC} = +24\text{V}$ )							mA
	$R_{SC} = 1.5\ \Omega$ TDE1747	-	480	-	-	-	-	
	$R_{SC} = 1.5\ \Omega$ TDE1647	-	540	-	-	-	-	
	$R_{SC} = 3.3\ \Omega$	-	-	-	-	230	-	
	$R_{SC} = \infty$	-	35	50	-	35	50	
$V_{CC}-V_O$	Output Saturation Voltage (output high) ( $R_{SC} = 0$ , $V_{I+}-V_{I-} \geq 50\text{ mV}$ )							V
	$I_O = 300\text{ mA}$ , $T_j = +25\text{ }^\circ\text{C}$	-	1.15	1.4	-	1.2	1.8(a)	
	$T_j = +150\text{ }^\circ\text{C}$	-	1.05	1.3	-	1.1	1.5(a)	
	$I_O = 150\text{ mA}$ , $T_j = +25\text{ }^\circ\text{C}$	-	-	-	-	1.2	1.8	
	TDF1607DP TDE1607DP $T_j = +150\text{ }^\circ\text{C}$	-	-	-	-	1.1	1.5	
$I_{OL}$	Low Level Output Current ( $V_O = 0$ , $V_{CC} = +24\text{ V}$ )							
	$T_j = +25\text{ }^\circ\text{C}$	-	-	-	-	0.01	10(a)	
	TDF1607DP TDE1607DP	-	-	-	-	-	100	
	$T_{min} \leq T_j \leq \text{max}$	-	0.01	10	-	0.01	50(a)	
	TDF1607DP TDE1607DP	-	-	-	-	-	500	

- Notes :**
- For operating at high temperature, the TDF1607, TDE1607, TDE1747, TDE1647/A must be derated based on a  $+150\text{ }^\circ\text{C}$  maximum junction temperature and a junction-ambient thermal resistance of  $185\text{ }^\circ\text{C/W}$  for Metal Can,  $120\text{ }^\circ\text{C/W}$  for Mini-dip and  $100\text{ }^\circ\text{C/W}$  for the SO14.
  - The offset voltage given is the maximum value of input voltage required to drive the output voltage within 2 V of the ground or the supply voltage.

Available output current versus limiting resistor

Peak short-circuit output current versus limiting resistor

TDE1747

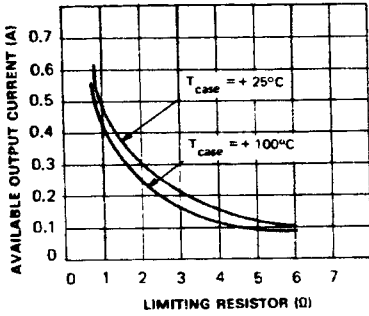

TDE1747

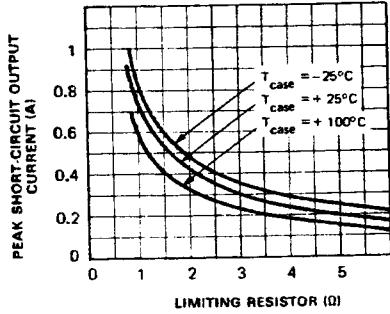

TDE1647,A - TDE1607 CM

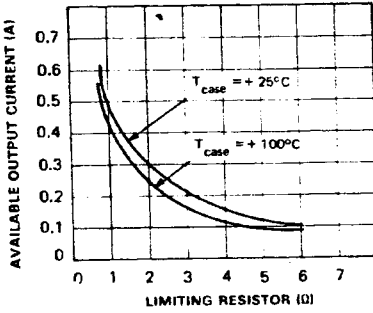

TDE1647,A - TDE1607 CM

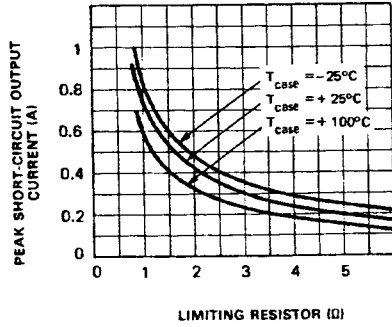

TDF1607 DP - TDE1607 DP

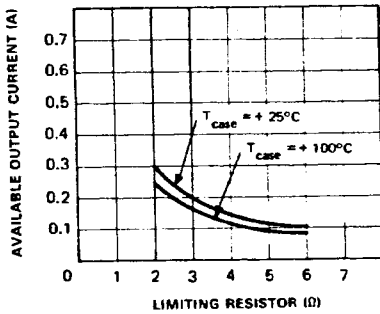

TDF1607 DP - TDE1607 DP

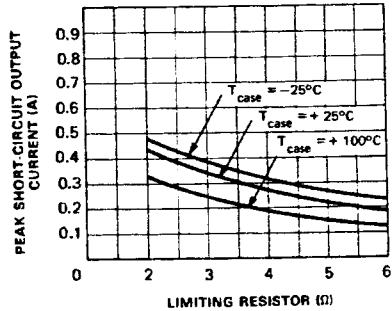

Short-circuit current versus case temperature

Minimum limiting resistor value versus supply voltage

TDE1747

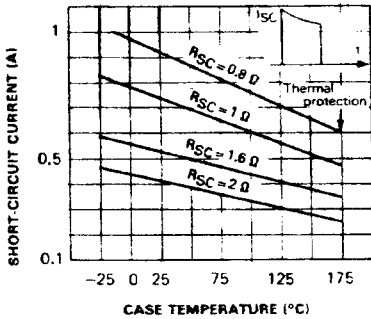

TDE1647,A - TDE1747

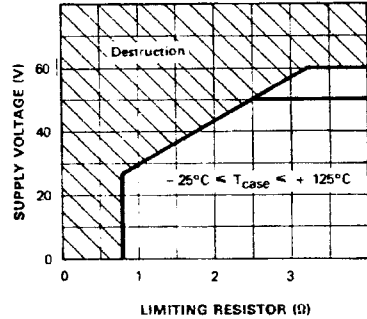

TDE1647,A - TDE1607 CM

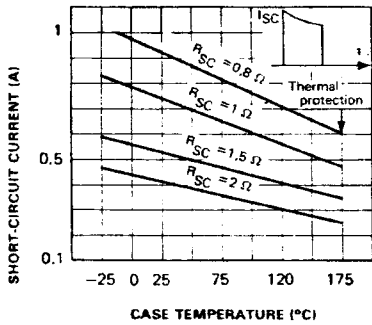

TDF1607 - TDE1607 DP

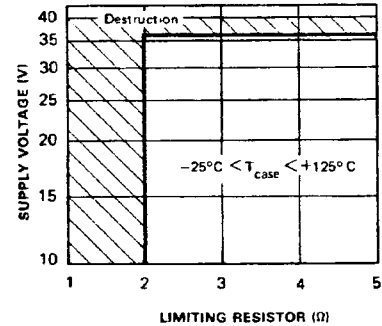

TDF1607 DP - TDE1607 DP

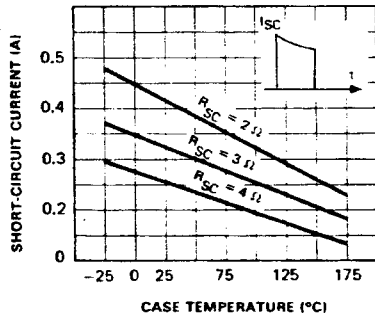

TDE1607 CM

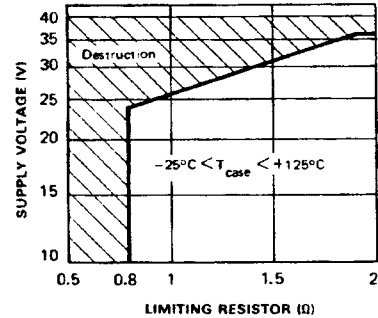

TDE1647,A - TDE1747 - TDE1607 CM

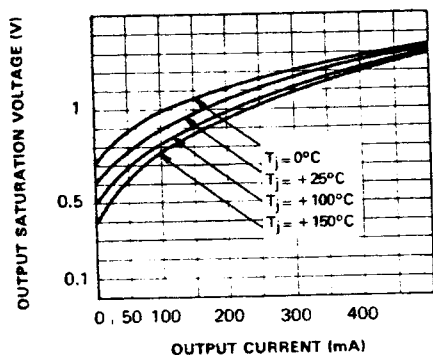

TDE1647,A - TDE1747

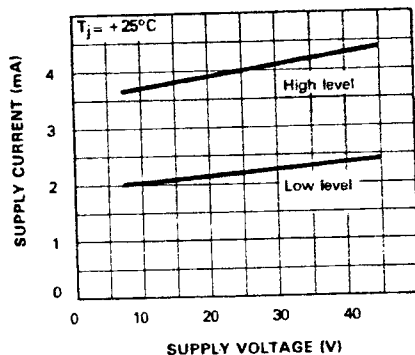

TDF1607 DP - TDE1607 DP

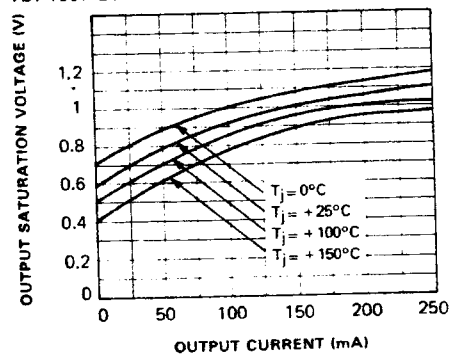

TDF1607 DP - TDE1607 DP

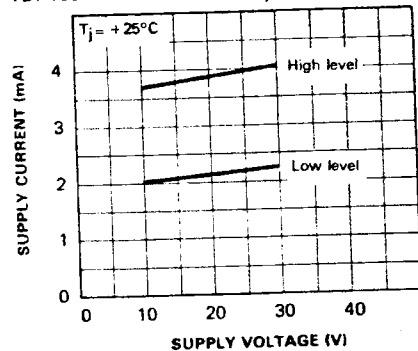

Supply current versus junction temperature

Safe operating area (non repetitive surge)

TDE1647,A - TDE1747 - TDE1607

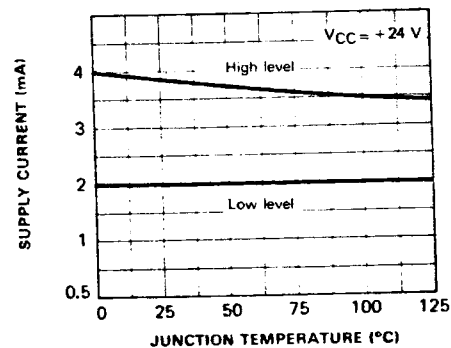

TDF1607 - TDE1607 - TDE1647,A - TDE1747

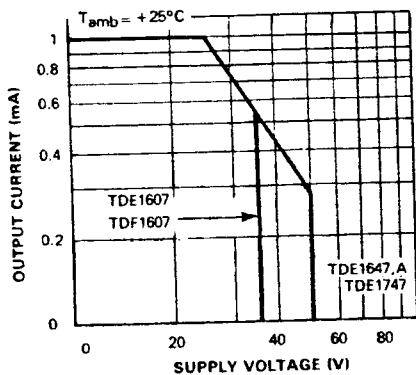

Response Time.

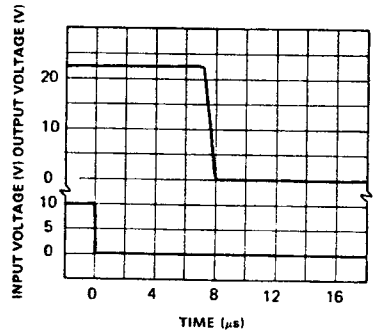
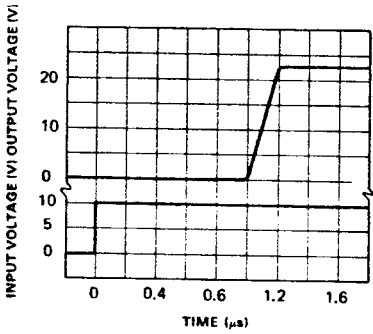

Test Circuit.

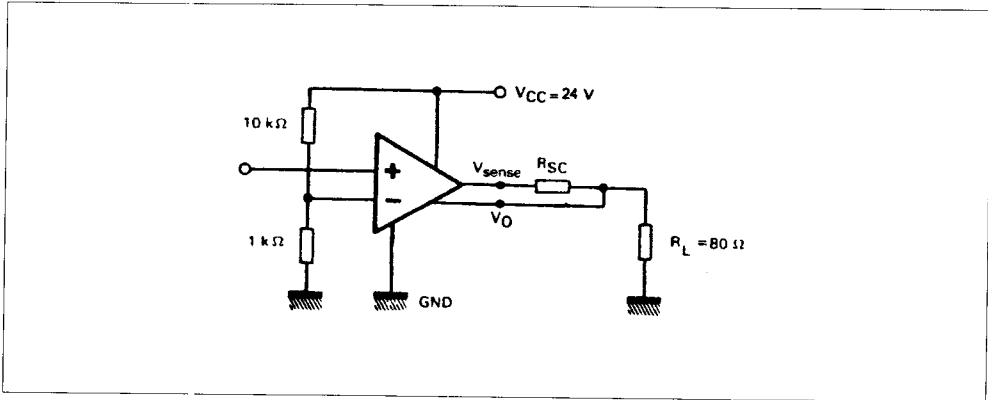



**TYPICAL APPLICATIONS**

TDE1647, A - TDE1747.

Basic Circuit.

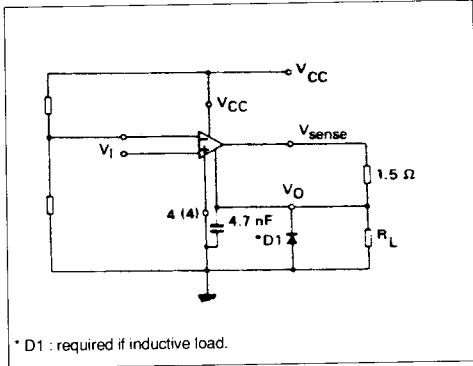

Output Current Extension (5 A).

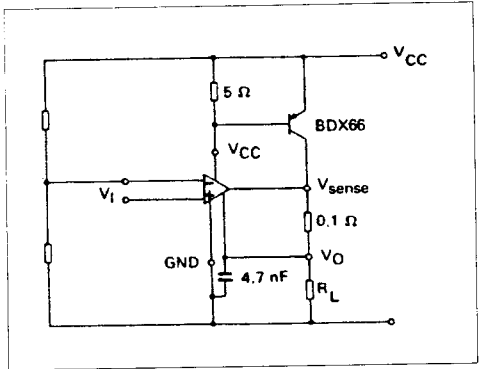

**DRIVING LOW IMPEDANCE RELAYS ( $I_O = 300 \text{ mA}$ )**

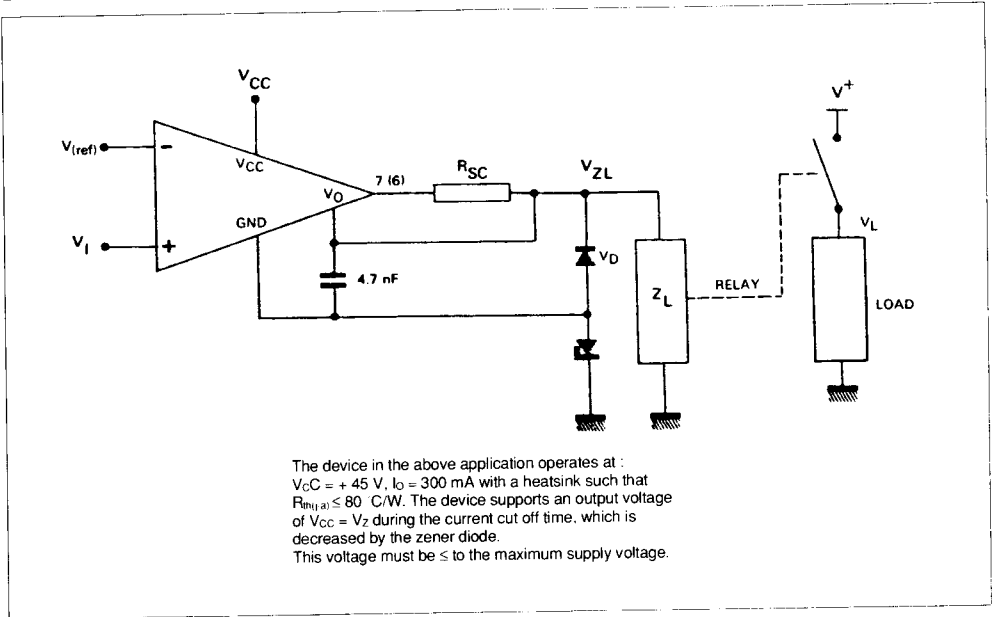

WAVEFORMS

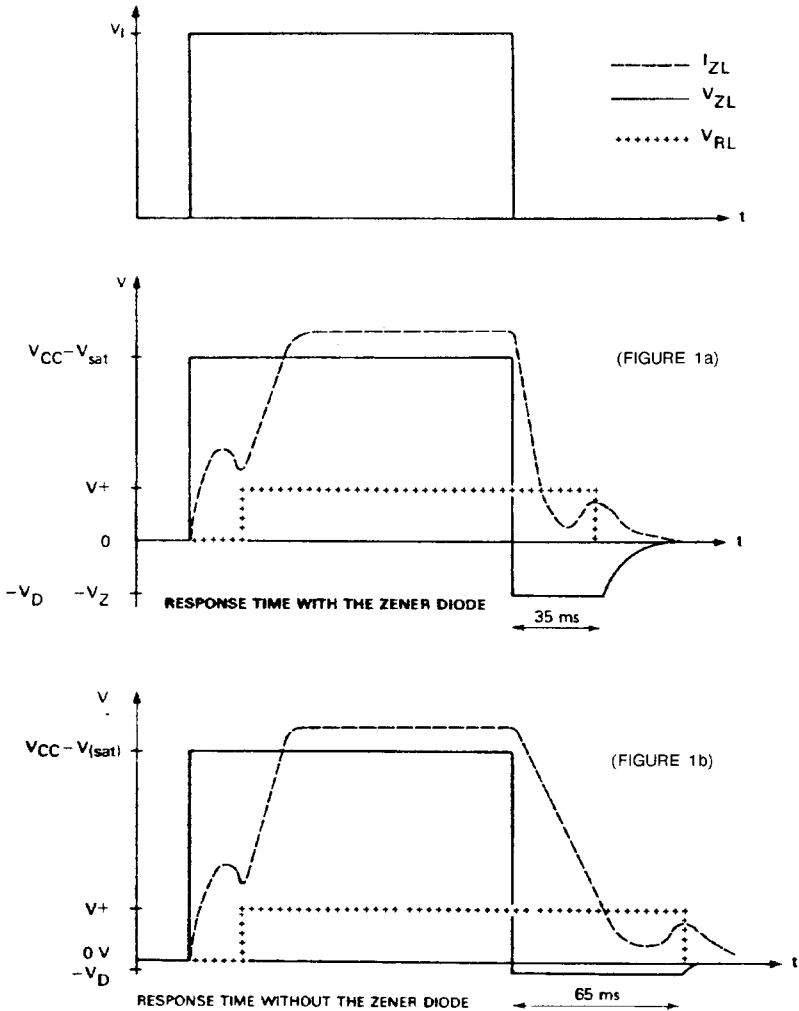

Note : 1. In the case of the figure 1a, the TDE1647, A-CM can withstand + 60 V @ 400 mA for  $t \leq 5\ \mu\text{s}$ .