

TDLNA2628SEP

22 – 31.5 GHz Low Noise Amplifier

Product Overview

Teledyne e2v HiRel's TDLNA2628SEP is a packaged, high-performance, low noise amplifier fabricated on a 90 nm pHEMT process. Covering 22 – 31.5 GHz, the TDLNA2628SEP provides 23 dB small signal gain and P1dB of 19 dBm, while supporting a noise figure of 1.6 dB and IM3 levels of -54 dBc (at Pout=0 dBm/tone).

Packaged in a small 4 mm x 4 mm plastic overmold QFN, the TDLNA2628SEP is matched to 50 ohms with integrated dc blocking caps on both I/O ports for easy handling and simple system integration.

The TDLNA2628SEP high performance and ease of handling make it ideal for satellite, military or commercial radar applications.

Lead-free and RoHS compliant.

Features

- Frequency Range: 22 – 31.5 GHz
- Noise Figure: 1.6 dB
- Small Signal Gain: 23 dB
- P1dB: 19 dBm
- IM3: -54 dBc (@ Pout=0 dBm/tone)
- Bias: VD = 3.5 V, IDQ = 90 mA, VG = -0.46 V
- Plastic Overmolded Package
- Package Dimensions: 4.0 x 4.0 x 0.85 mm

Space Enhanced Product (EP) Qualification

- Long term availability –10 years+
- Extended temperatures
 - Cold temperature down to -55 °C
 - Hot temperatures up to +125 °C
- Baseline control
 - Guaranteed traceability throughout the process
 - Product repeatability
- Full qualification over specified temperature range
- Extended Change Notification
- Customized ordering options
- Standard Teledyne part number

Functional Block

Diagram

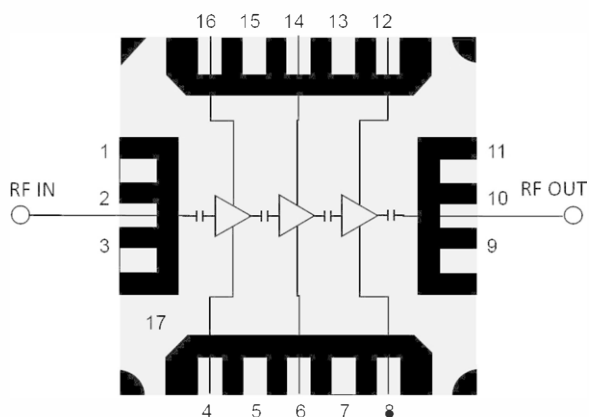

Absolute Maximum Ratings

Parameter	Value	Units
Drain Voltage (V_D)	4.5	V
Drain Current ($I_{D1}/I_{D2}/I_{D3}$)	45/45/160	mA
Gate Voltage Range	-1.3 to 0	V
Gate Current ($I_{G1}/I_{G2}/I_{G3}$ at 125 °C)	5.0/5.0/6.6	mA
RF Input Power (50 Ω , 85 °C)	20	dBm
Channel Temperature, T_{CH}	175	°C
Mounting Temperature (30 seconds)	260	°C
Storage Temperature	-55 to 150	°C

Exceeding any one or a combination of the Absolute Maximum Rating conditions may cause permanent damage to device. Extended application of Absolute Maximum Rating conditions to the device may reduce device reliability.

Recommended Operating Conditions

Parameter	Value	Units
Drain Voltage	3.5	V
Drain Current (quiescent, I_{DQ})	90	mA
Drain Current (I_D , Low noise / P_{SAT})	90 / 175	mA
Gate Voltage (typical)	-0.46	V
Operating Temperature Range	-55 to 125	°C

Electrical specifications are measured at specified test conditions. Specifications are not guaranteed over all recommended operating conditions.

Electrical Specifications

Test conditions unless otherwise noted: $V_D = +3.5$ V, $I_{DQ} = 90$ mA, Temp. = +25 °C. Data de-embedded to device reference plane.

Parameter	Min	Typical	Max	Units
Frequency	22		31.5	GHz
Small Signal Gain	19	23		dB
Noise Figure		1.6		dB
1-dB Compression Point		19		dBm
Input Return Loss		11		dB
Output Return Loss		16		dB
3 RD Order Intermodulation level ($P_{out}=0$ dBm/tone)		-54		dBc
Output TOI ($P_{out}=0$ dBm/tone)		27		dBm
Gain Temperature Coefficient		-0.013		dB/°C

Small Signal Performance Plots

Test conditions unless otherwise noted: $V_D = +3.5\text{ V}$, $I_{DQ} = 90\text{ mA}$, $\text{Temp.} = +25\text{ }^\circ\text{C}$.

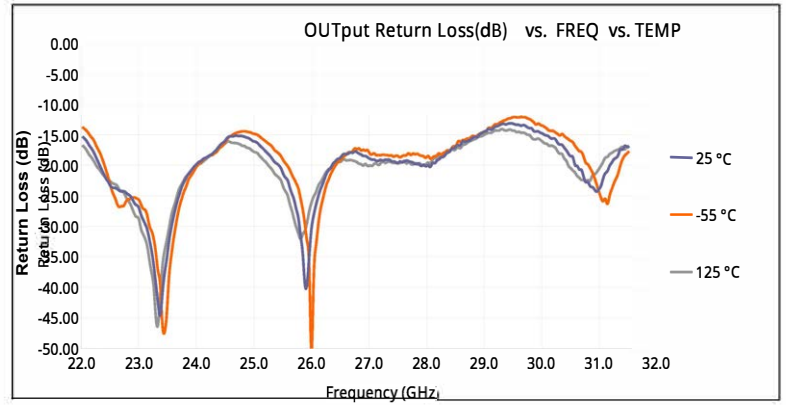
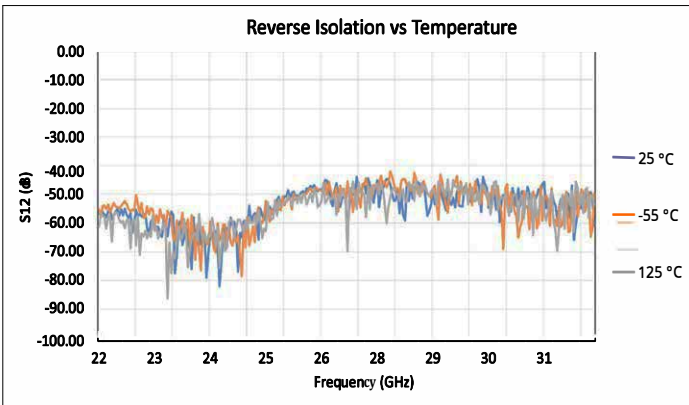
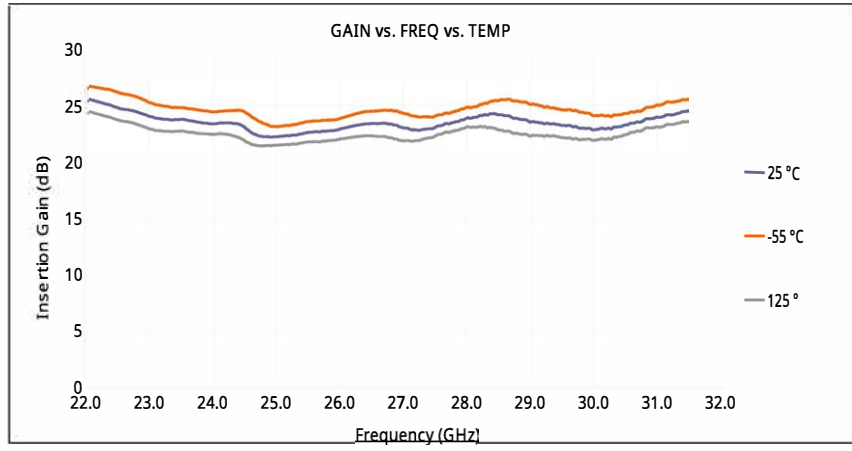
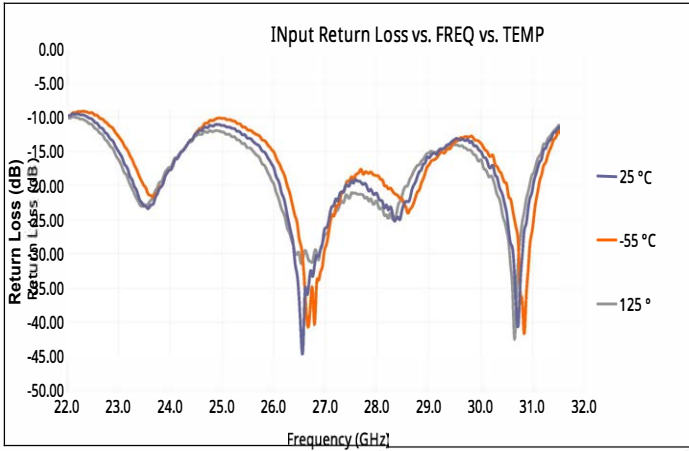

Small Signal Performance Plots

Test conditions unless otherwise noted: $V_D = +3.5\text{ V}$, $I_{DQ} = 90\text{ mA}$, Temp. = $+25\text{ }^\circ\text{C}$. Data de-embedded to MMIC bond wires.

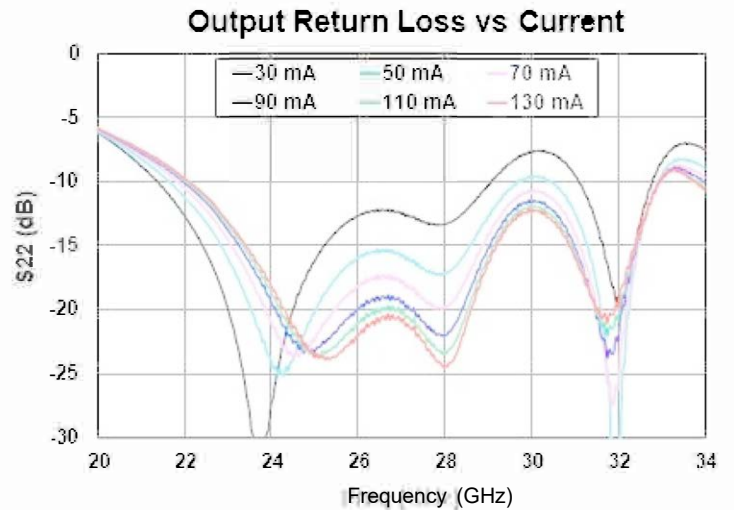
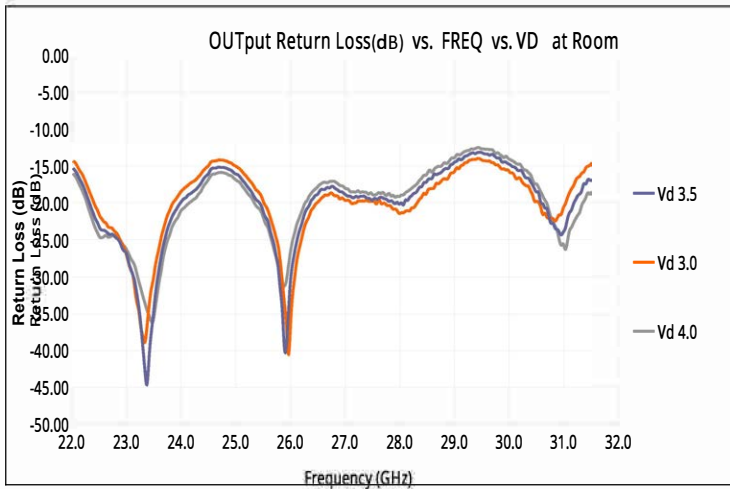
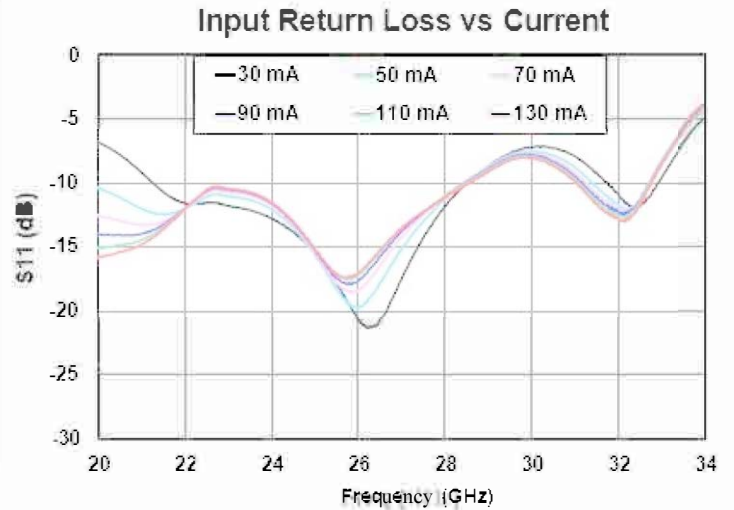
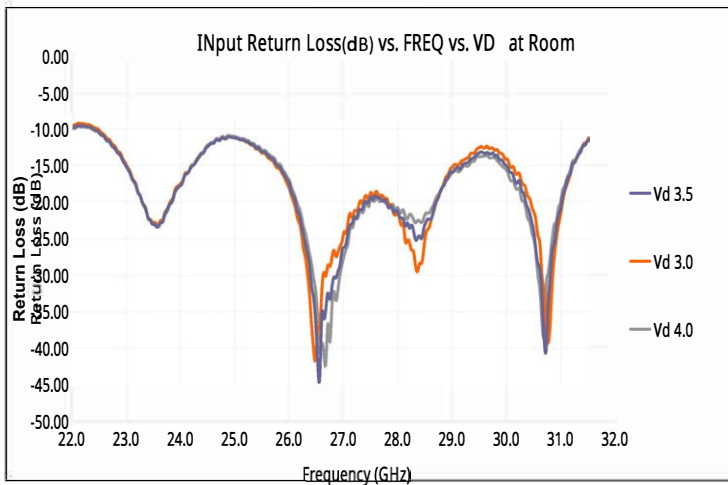
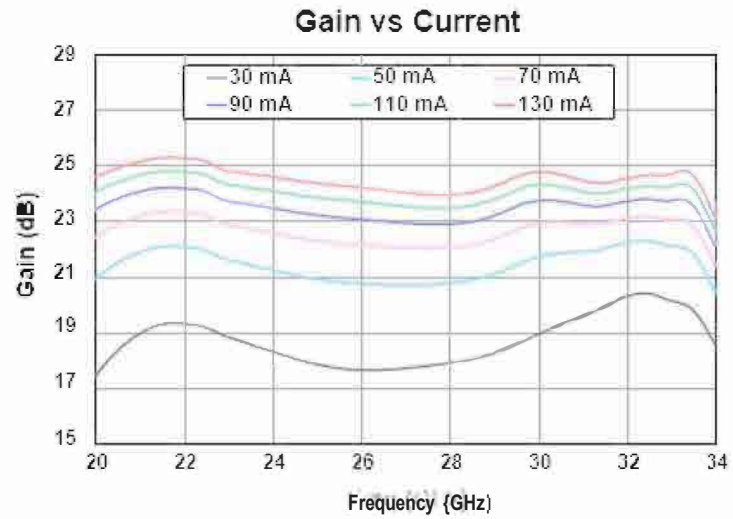
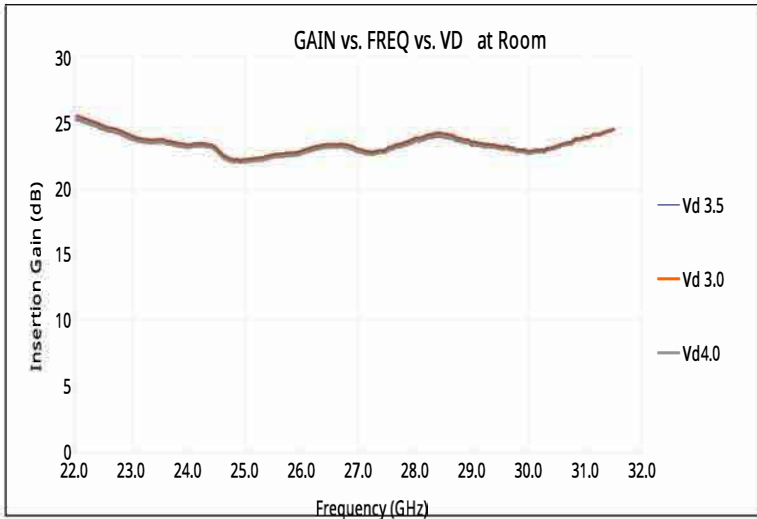

Noise Figure Performance Plots

Test conditions unless otherwise noted: $V_D = +3.5\text{ V}$, $I_{DQ} = 90\text{ mA}$, Temp. = $+25\text{ }^\circ\text{C}$. Data de-embedded to MMIC bond wires.

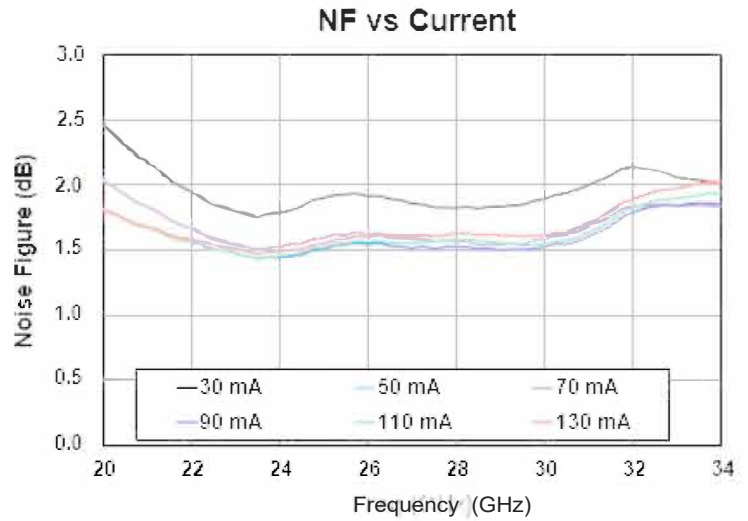
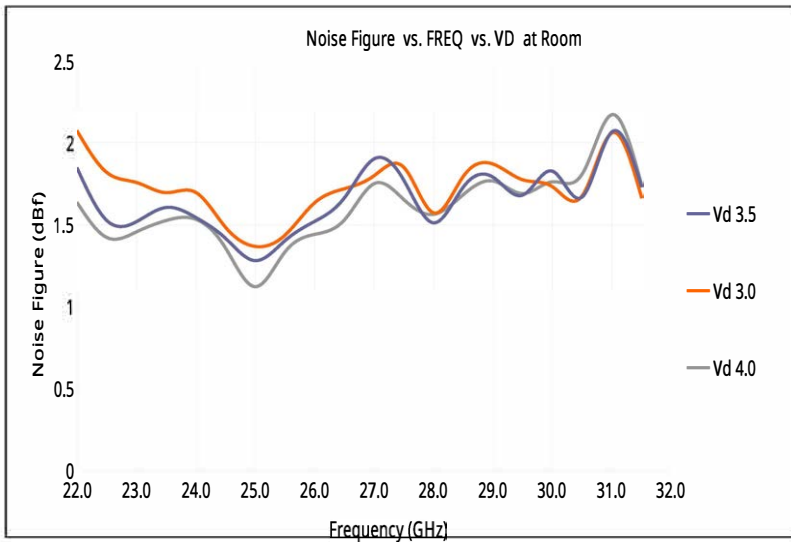
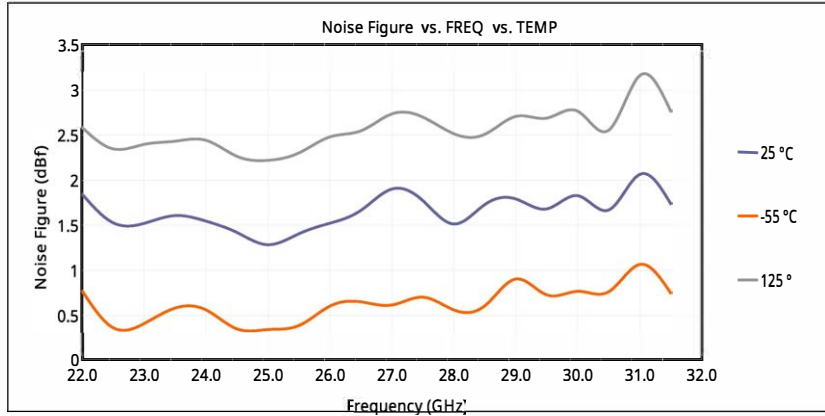

Large Signal Performance Plots

Test conditions unless otherwise noted: $V_D = +3.5\text{ V}$, $I_{DQ} = 90\text{ mA}$, Temp. = $+25\text{ }^\circ\text{C}$. Data de-embedded to MMIC bond wires.

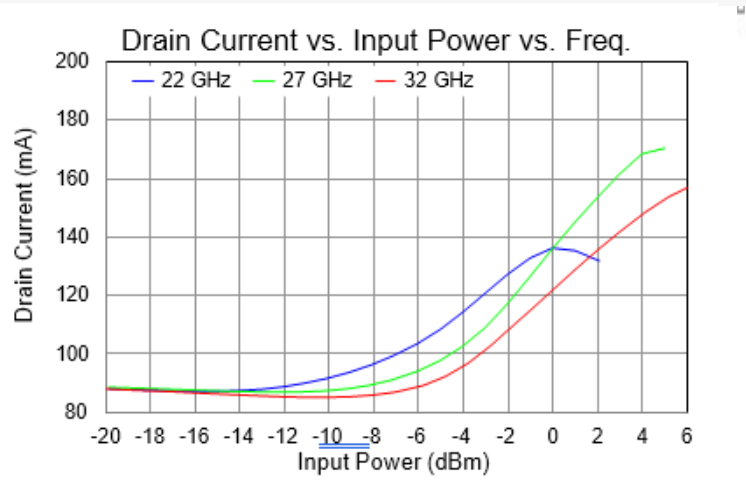
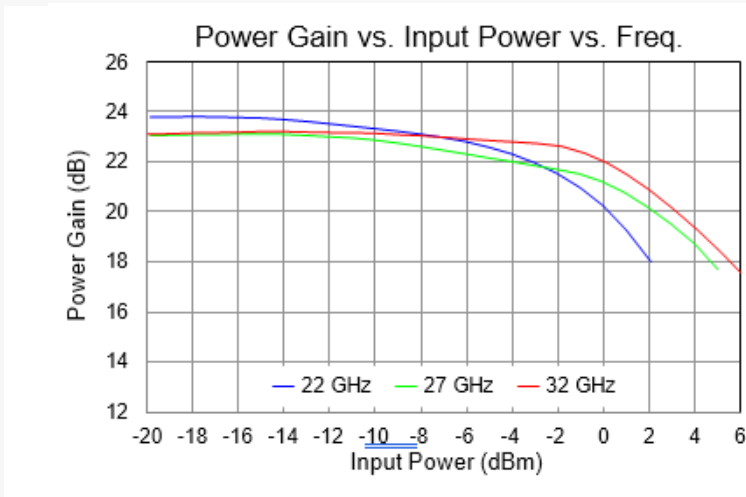
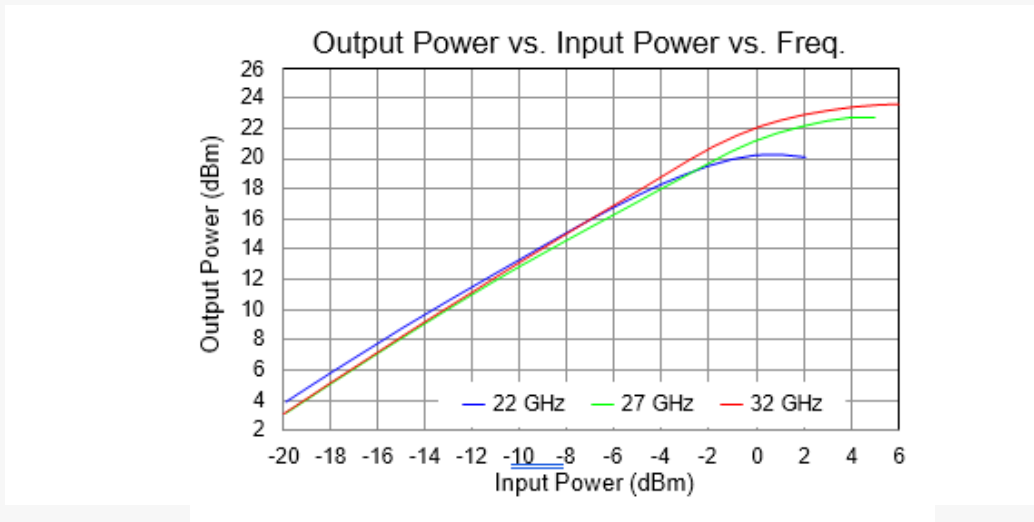
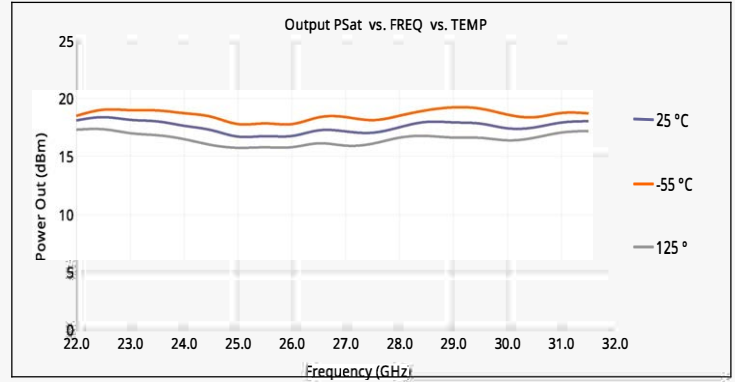
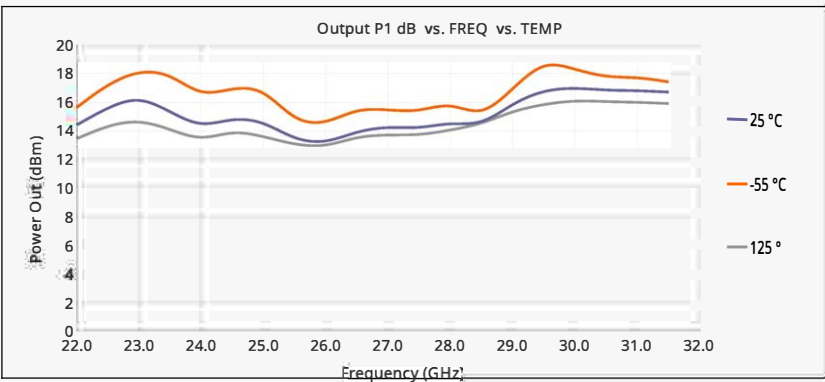

Linearity Performance Plots

Test conditions unless otherwise noted: $V_D = +3.5\text{ V}$, $I_{DQ} = 90\text{ mA}$, Temp. = $+25\text{ }^\circ\text{C}$. Data de-embedded to MMIC bond wires.

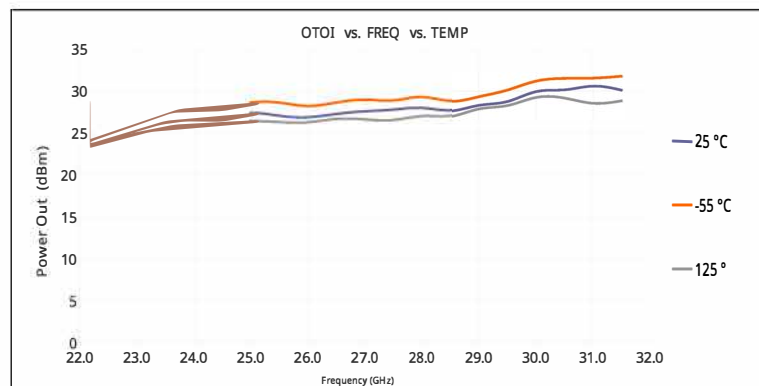
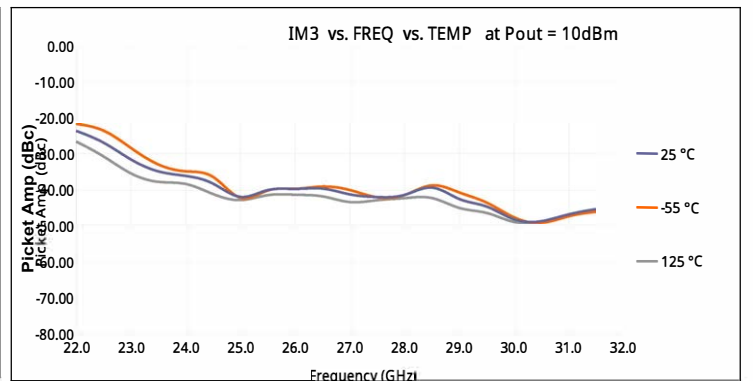
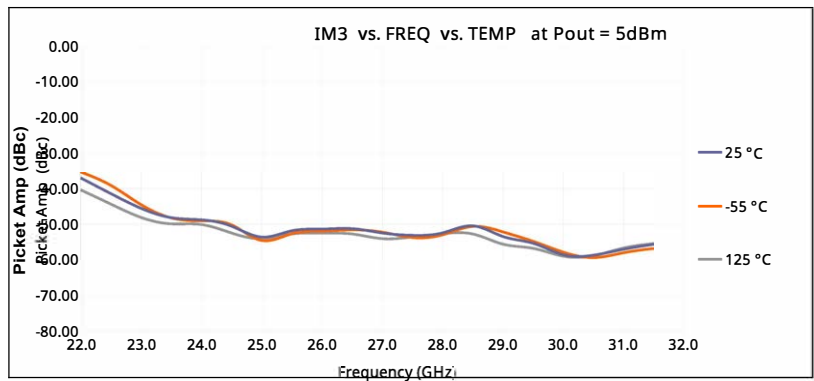
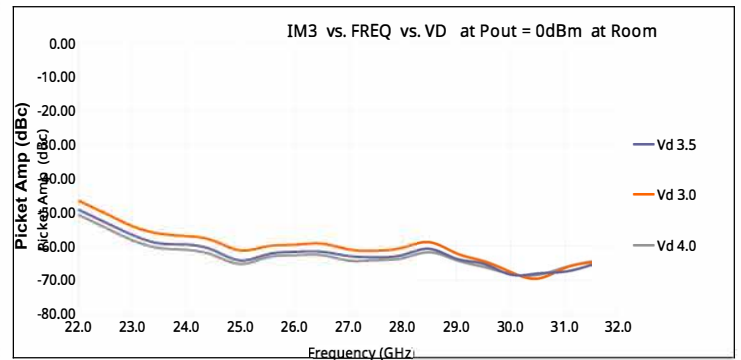
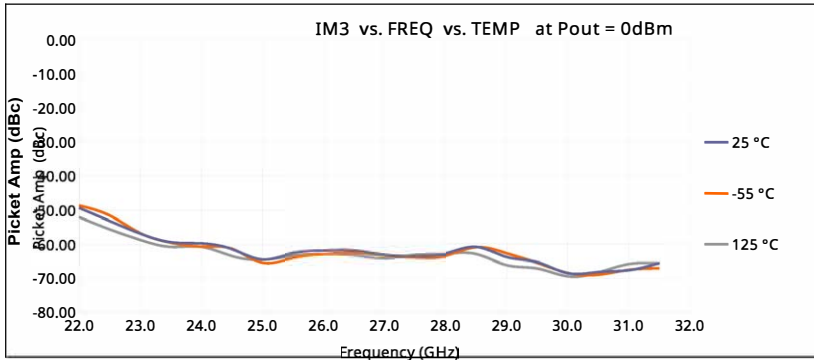

Mechanical Drawing and Pad Description

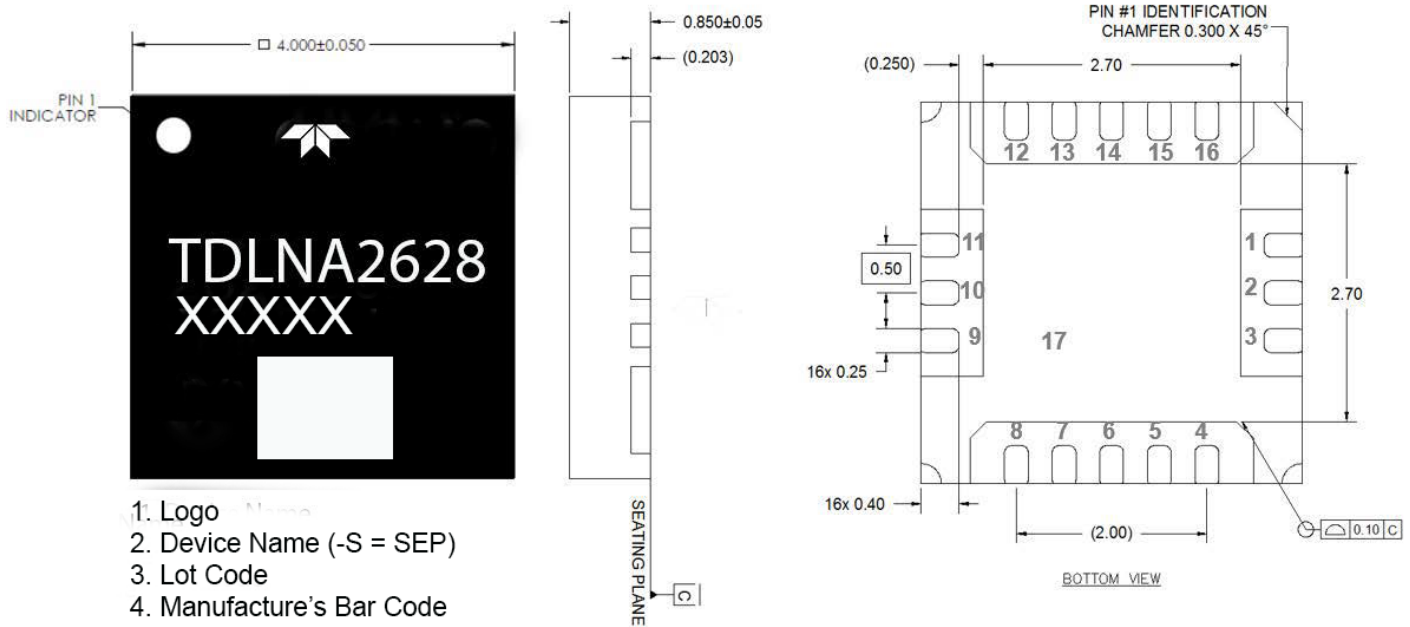

Dimensions in mm, package is mold encapsulated with NiPdAu plated leads

Part Marking: TDLNA2628, Lot Code/Lot Number: XXXXX. Note: -S will be appended to the part number for the SEP screening option (space screening option).

Pin Number	Label	Description
1, 3, 9, 11, 17 (slug)	GND	GROUND
2	RF Input	Matched to 50 ohms, DC blocked
4	VG1	Gate Voltage; bias network is required (V_G can be tied together at PCB)
6	VG2	Gate Voltage; bias network is required (V_G can be tied together at PCB)
8	VG3	Gate Voltage; bias network is required (V_G can be tied together at PCB)
10	RF Output	Matched to 50 ohms, DC blocked
12	VD3	Drain Voltage; bias network is required (V_D can be tied together at PCB)
14	VD2	Drain Voltage; bias network is required (V_D can be tied together at PCB)
16	VD1	Drain Voltage; bias network is required (V_D can be tied together at PCB)
5, 7, 13, 15	N/C	No internal connection. Recommend to GND at the PCB level

Thermal and Reliability Information

Parameter	Test Conditions	Value	Units
Thermal Resistance (θ_{JC}) ⁽¹⁾	$T_{base} = 85\text{ }^{\circ}\text{C}$, $V_D = 3.5\text{ V}$, $I_{DQ} = 90\text{ mA}$ Quiescent/Small Signal operation, $P_{DISS} = 0.315\text{ W}$	65.1	$^{\circ}\text{C/W}$
Channel Temperature, T_{CH} (Under RF)		105.5	$^{\circ}\text{C}$
Median Lifetime (T_M)		1.226E08	Hrs

Notes:

1. Die mounted to 40 mil CuMo carrier plate with AuSn eutectic. Thermal resistance measured at back of carrier plate.

Application Circuit and Evaluation Board Layout

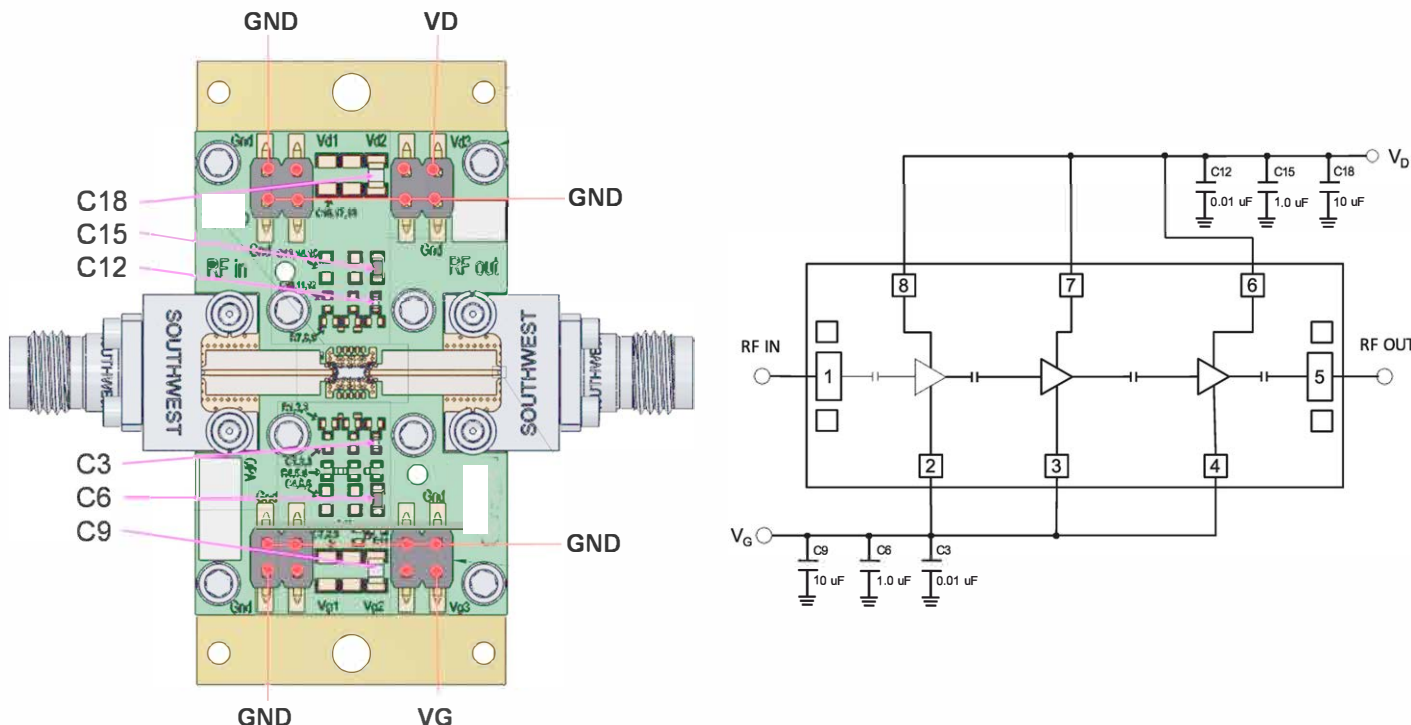

Notes:

1. See Evaluation Board PCB Information for material and stack up.

Bias-up Procedure

1. Set I_D limit to 220 mA, I_G limit to 10 mA
2. Set V_G to -1.5 V
3. Set V_D +3.5 V
4. Adjust V_G more positive until $I_{DQ} = 90\text{ mA}$
($V_G \approx -0.46\text{ V}$ Typical)
5. Apply RF signal

Bias-down Procedure

1. Turn off RF signal
2. Reduce V_G to -1.5 V . Ensure $I_{DQ} \approx 0\text{ mA}$
3. Set V_D to 0 V
4. Turn off V_D supply
5. Turn off V_G supply

Bill of Materials

Ref. Des.	Value	Description	Manuf.	Part Number
C3, C12	0.01 μF	CAP 0.01 μF +/-10% 50 V 0402 X7R ROHS	Various	
C6, C15	1.0 μF	CAP 1.0 μF +/-10% 16 V 0603 X7R ROHS	Various	
C9, C18	10 μF	CAP CER 10 μF 10 V X7R 10% 0805 TDK ROHS	Various	
RF IN, RF OUT	2.40 mm	2.40 mm END LAUNCH CONNECTOR	Southwest Microwave	1492-04A-5

Thermal and Reliability Information

Parameter	Test Conditions	Value	Units
Thermal Resistance (θ_{JC}) ⁽¹⁾	Tbase = 85 °C, VD = 3.5 V, IDQ = 90 mA	65.1	°C/W
Channel Temperature (T_{CH})	Quiescent/Small Signal operation	105.5	°C
Median Lifetime (T_M)	PDISS = 0.315 W	1.236E08	Hrs

Median Lifetime

Test Conditions: $V_D = 4$ V
 Failure Criteria = 10% reduction in I_{D_MAX}

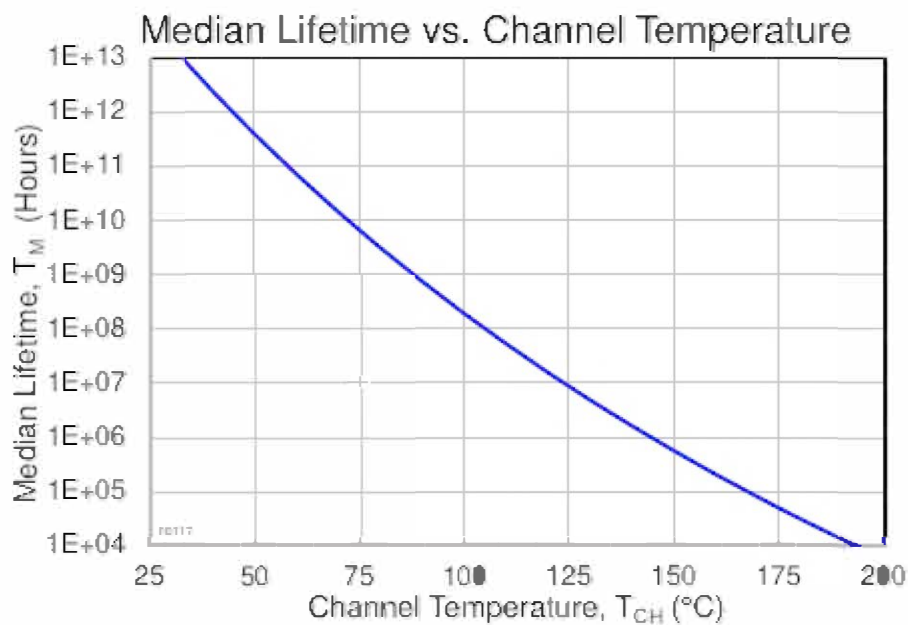

Solderability

1. Compatible with the latest version of J-STD-020, Lead-free solder, 260 °C peak reflow temperature.

Recommended Soldering Temperature Profile

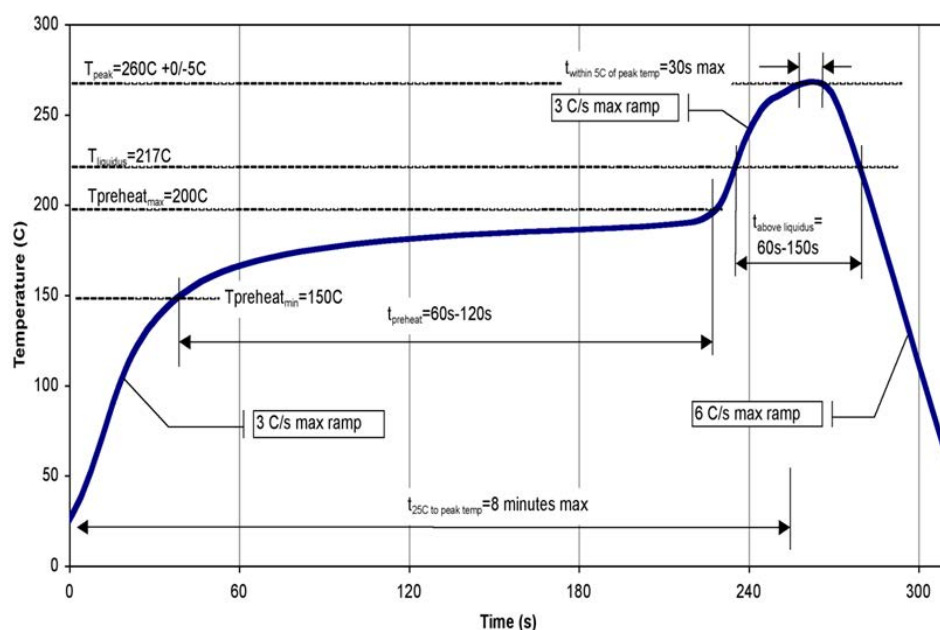

Handling Precautions

Parameter	Rating	Standard
ESD – Human Body Model (HBM)	1A	ANSI/ESD/JEDEC JS-001
ESD – Charge Device Model (CDM)	C2a	ANSI/ESD/JEDEC JS-002
MSL – Moisture Sensitivity Level	3	IPC/JEDEC J-STD-020



Caution!
ESD-Sensitive Device

RoHS Compliance

This product is compliant with the 2011/65/EU RoHS directive (Restrictions on the Use of Certain Hazardous Substances in Electrical and Electronic Equipment), as amended by Directive 2015/863/EU.

This product also has the following attributes:

- Lead Free
- Halogen Free (Chlorine, Bromine)
- Antimony Free
- TBBP-A (C₁₅H₁₂Br₄O₂) Free
- SVHC Free

Ordering Information

Order Code	Description	Package	Shipping Method
TDLNA2628SEP	22 – 31.5 GHz Low Noise Amplifier	16-QFN	Tray
TDLNA2628EP	22 – 31.5 GHz Low Noise Amplifier	16-QFN	Tray
TDLNA2628EP-00	EVK		Box

Revision Information

Document	Description - Date	Change/Revision Details
TDLNA2628 Aug-1-2023 Rev. –	Product Specification - 08-01-2023	Initial Release / Revision –
TDLNA2028 April-23-2024 Rev 1	Order Code for EVK updated 04_23_2024	Removed "EP" from the Order Code

Document Category Definitions:

Advance Information

The product is in a formative or design stage. The data sheet contains design target specifications for product development. Specifications and features may change in any manner without notice.

Preliminary Specification

The data sheet contains preliminary data. Additional data may be added at a later date. Teledyne e2v HiRel Electronics reserves the right to change specifications at any time without notice in order to supply the best possible product.

Product Specification

The data sheet contains final data. In the event Teledyne e2v HiRel Electronics decides to change the specifications, Teledyne e2v HiRel Electronics will notify customers of the intended changes by issuing a CNF (Customer Notification Form).

Sales Contact

For additional information, Email us at: hirel@teledyne.com website: www.tdehirel.com

Disclaimers

The information in this document is believed to be reliable. However, Teledyne e2v HiRel Electronics assumes no liability for the use of this information. Use shall be entirely at the user's own risk. No patent rights or licenses to any circuits described in this document are implied or granted to any third party. Teledyne e2v's products are not designed or intended for use in devices or systems intended for surgical implant, or in other applications intended to support or sustain life, or in any application in which the failure of the Teledyne e2v product could create a situation in which personal injury or death might occur. Teledyne e2v assumes no liability for damages, including consequential or incidental damages, arising out of the use of its products in such applications.

Copyright and Trademark

Trademarks are the property of their respective owners.

©2023, Teledyne e2v HiRel Electronics. All rights reserved.

