

N-Channel Enhancement Mode MOSFET

TDM31066

DESCRIPTION

The TDM31066 uses advanced trench technology to provide excellent RDS(ON) and low gate charge. This device is suitable for use as a load switch or in PWM applications.

GENERAL FEATURES

- RDS(ON) < 18.2mΩ @ VGS=4.5V
RDS(ON) < 13.5mΩ @ VGS=10V
- High Power and current handling capability
- Lead free product is available
- TO-252 Package

Application

- PWM applications
- Load switch
- Power management
- Hard Switched and High Frequency Circuits

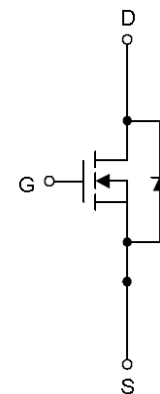

N-Channel MOSFET

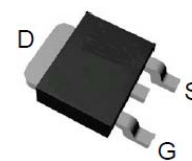

Top View of TO-252-2

ABSOLUTE MAXIMUM RATINGS(T_A=25°C unless otherwise noted)

Parameter	Symbol	Limit	Unit
Drain-Source Voltage	V _{DS}	100	V
Gate-Source Voltage	V _{GS}	+20	V
Diode Continuous Forward Current	I _S (T _C =25°C)	21	A
Pulsed Drain Current	I _{DM} (T _C =25°C)	172	A
Drain Current @ Continuous	I _D (T _C =25°C)	54	A
	I _D (T _C =100°C)	33	A
Maximum Power Dissipation(t _≤ 10s)	P _D (T _C =25°C)	83	W
	P _D (T _C =100°C)	33	W
Drain Current @ Continuous	I _D (T _A =25°C)	9.0	A
	I _D (T _A =70°C)	7.0	A
Maximum Power Dissipation(t _≤ 10s)	P _D (T _A =25°C)	2.4	W
	P _D (T _A =70°C)	1.6	W
Thermal Resistance,Junction-to-Case	R _{θJC}	1.5	°C/W
Thermal Resistance,Junction-to-Ambient (Note 1)	R _{θJA} (Steady State)	62.5	°C/W
Avalanche Current, Single pulse	I _{AS} (L=0.5mH)	18	A
Avalanche Energy, Single pulse	E _{AS} (L=0.5mH)	81	mJ
Maximum Operating Junction Temperature	T _J	150	°C
Storage Temperature Range	T _{STG}	-55 To 150	°C

N-Channel Enhancement Mode MOSFET

TDM31066

ELECTRICAL CHARACTERISTICS ($T_A=25^{\circ}\text{C}$ unless otherwise noted)

Parameter	Symbol	Condition	Min	Typ	Max	Unit
OFF CHARACTERISTICS						
Drain-Source Breakdown Voltage	BV_{DSS}	$V_{GS}=0V, I_D=250\mu A$	100	-	-	V
Zero Gate Voltage Drain Current	I_{DSS}	$V_{DS}=80V, V_{GS}=0V$	-	-	1	μA
Gate-Body Leakage Current	I_{GSS}	$V_{GS}=\pm 20V, V_{DS}=0V$	-	-	± 100	nA
ON CHARACTERISTICS (Note 2)						
Gate Threshold Voltage	$V_{GS(th)}$	$V_{DS}=V_{GS}, I_D=250\mu A$	1	2	3	V
Drain-Source On-State Resistance	$R_{DS(ON)}$	$V_{GS}=4.5V, I_D=15A$	-	14	18.2	m Ω
	$R_{DS(ON)}$	$V_{GS}=10V, I_D=20A$	-	11.2	13.5	m Ω
DYNAMIC CHARACTERISTICS (Note3)						
Gate Resistance	R_G	$V_{DS}=0V, V_{GS}=0V, F=1.0MHz$	-	1.0	-	Ω
Input Capacitance	C_{iss}	$V_{DS}=30V, V_{GS}=0V, F=1.0MHz$	-	1440	1880	PF
Output Capacitance	C_{oss}		-	405	-	PF
Reverse Transfer Capacitance	C_{rss}		-	30	-	PF
SWITCHING CHARACTERISTICS (Note 3)						
Turn-on Delay Time	$t_{d(on)}$	$V_{DS}=30V, R_L=30\Omega, V_{GEN}=10V, R_G=6\Omega, I_D=1A$	-	16	29	nS
Turn-on Rise Time	t_r		-	7	13	nS
Turn-Off Delay Time	$t_{d(off)}$		-	38	69	nS
Turn-Off Fall Time	t_f		-	41	74	nS
Total Gate Charge	Q_g	$V_{DS}=50V, I_D=20A, V_{GS}=10V$	-	28	40	nC
Gate-Source Charge	Q_{gs}		-	4.8	-	nC
Gate-Drain Charge	Q_{gd}		-	5.8	-	nC
Body Diode Reverse Recovery Time	T_{rr}	$I_F=20A, di/dt=100A/\mu s$	-	45	-	nS
Body Diode Reverse Recovery Charge	Q_{rr}		-	86	-	nC
DRAIN-SOURCE DIODE CHARACTERISTICS						
Diode Forward Voltage (Note 2)	V_{SD}	$V_{GS}=0V, I_S=2A$	-	0.8	1.3	V

NOTES:

1. Pulse width limited by max. junction temperature.
2. Pulse Test: Pulse Width $\leq 300\mu s$, Duty Cycle $\leq 2\%$.
3. Guaranteed by design, not subject to production testing

Typical Operating Characteristics

Power Dissipation

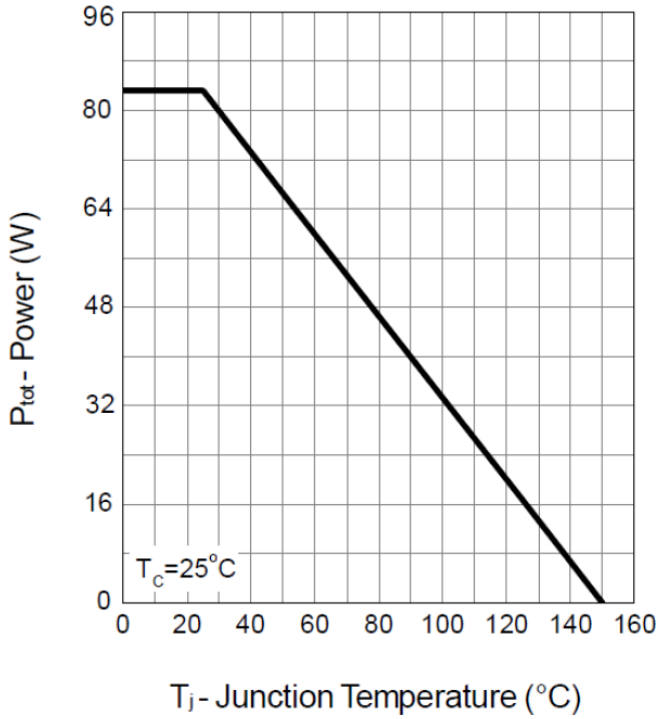

Drain Current

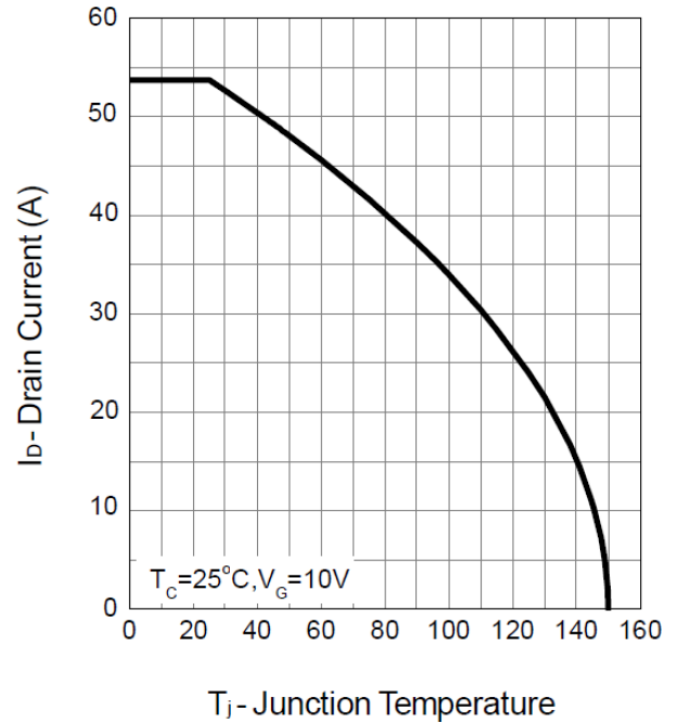

Safe Operation Area

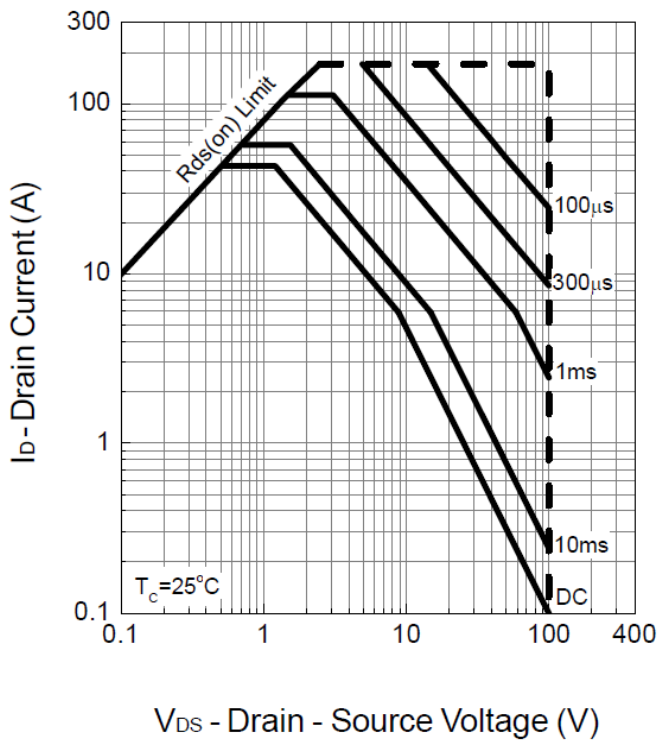

Thermal Transient Impedance

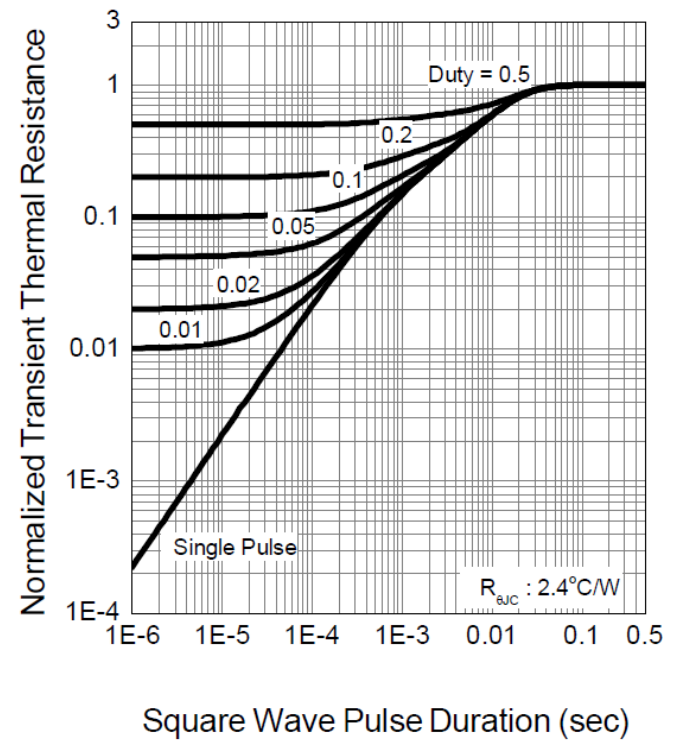

Typical Operating Characteristics (Cont.)

Output Characteristics

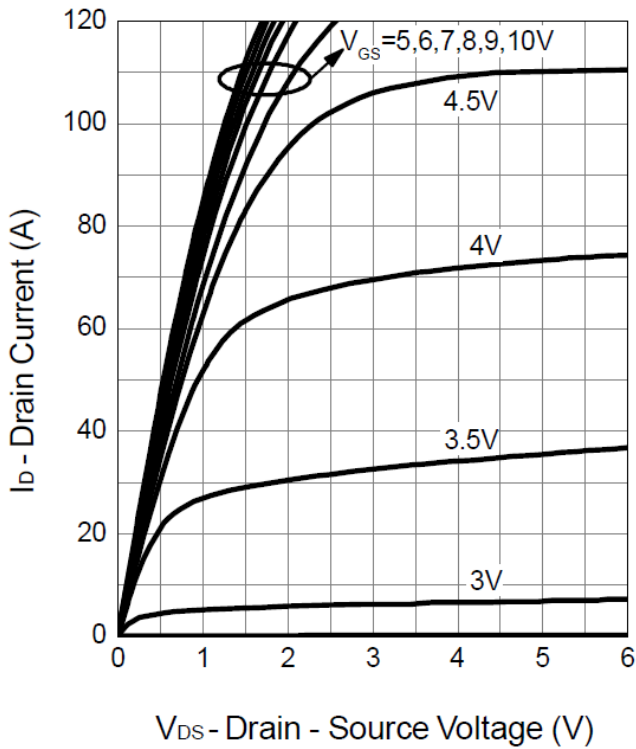

Drain-Source On Resistance

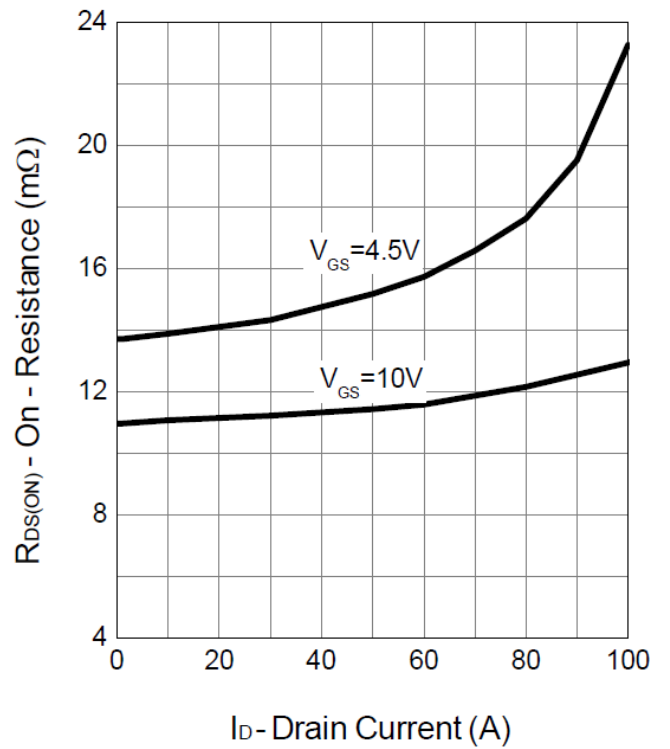

Gate-Source On Resistance

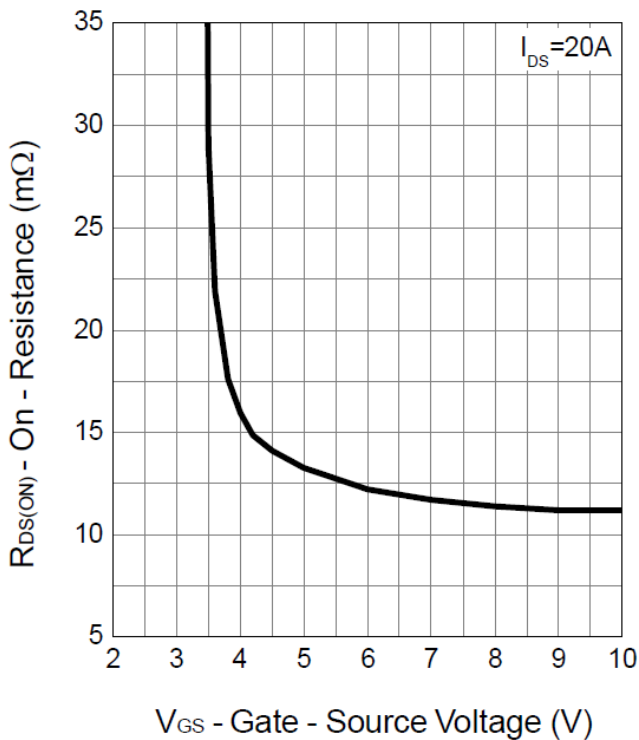

Gate Threshold Voltage

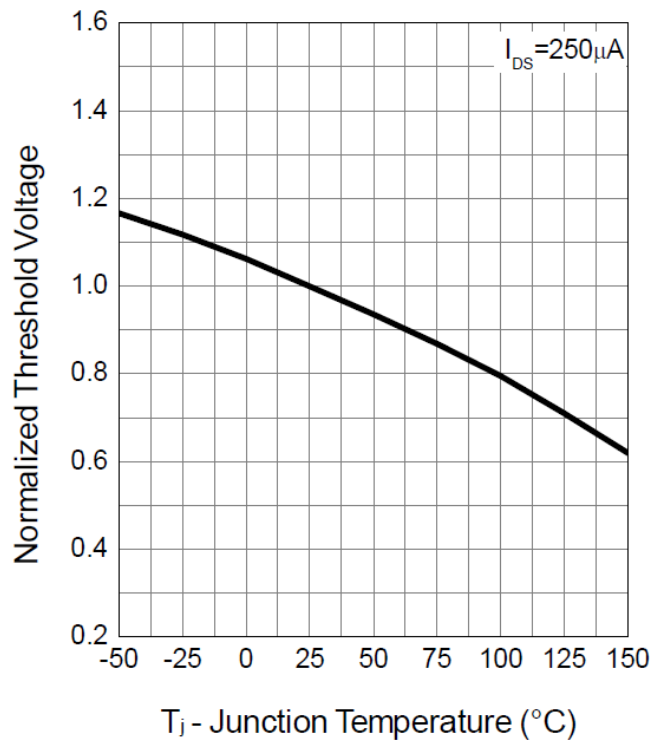

Typical Operating Characteristics (Cont.)

Drain-Source On Resistance

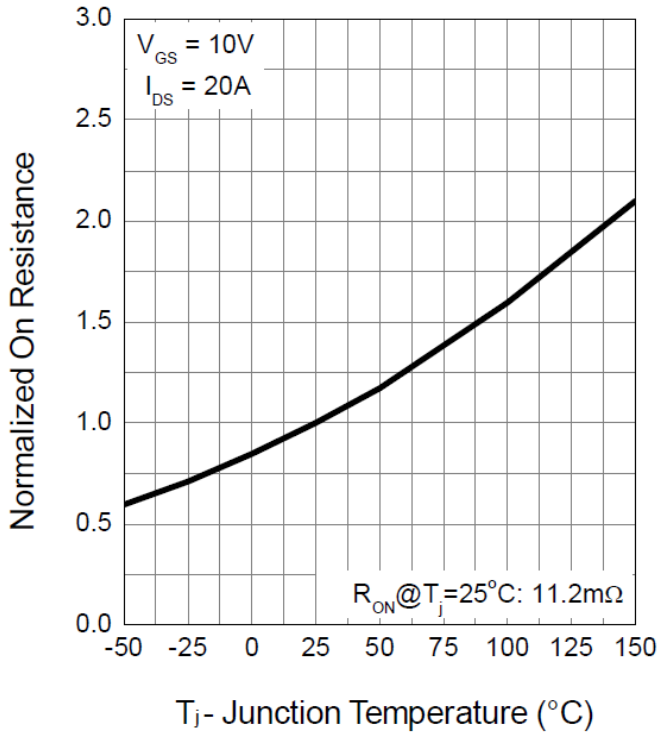

Source-Drain Diode Forward

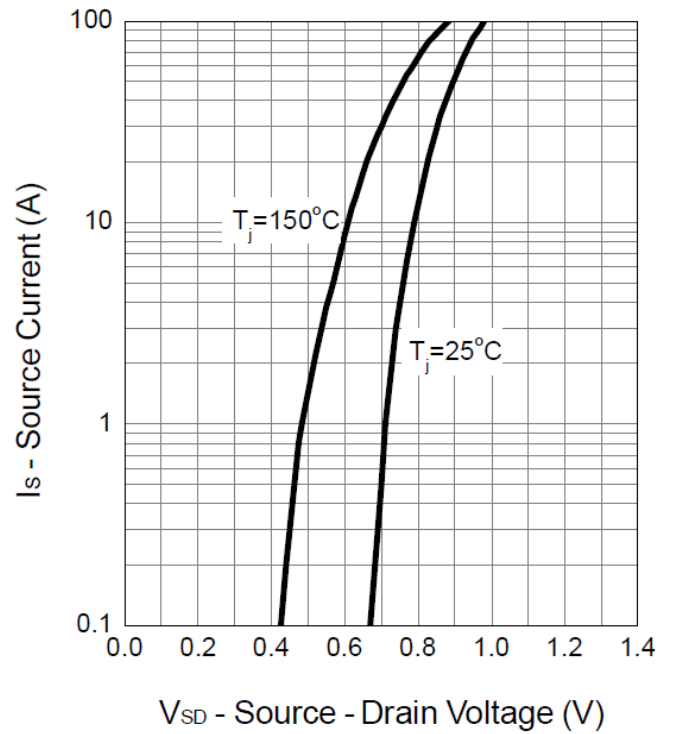

Capacitance

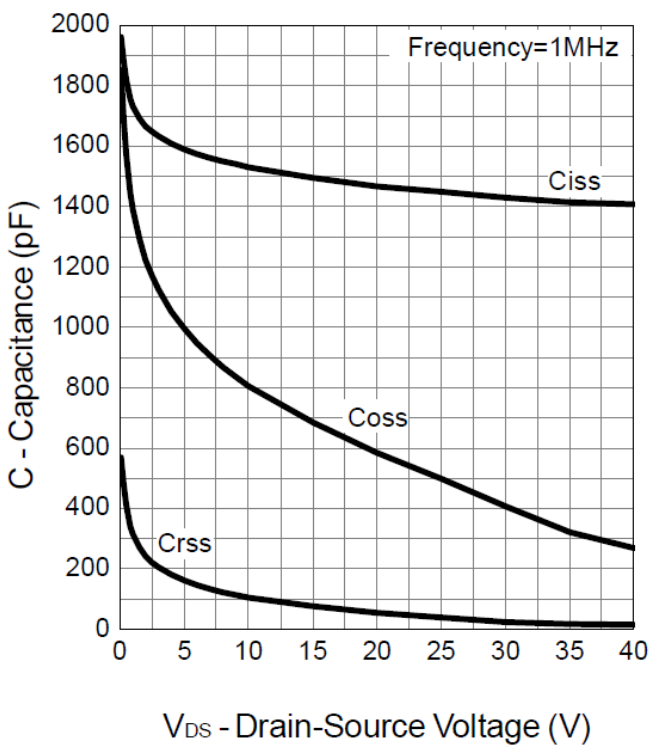

Gate Charge

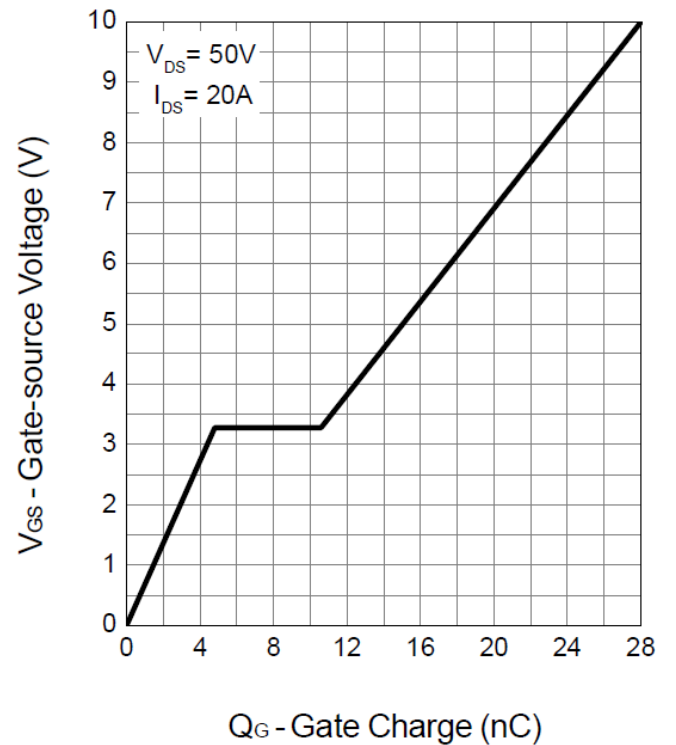

Package Information

TO252 Package

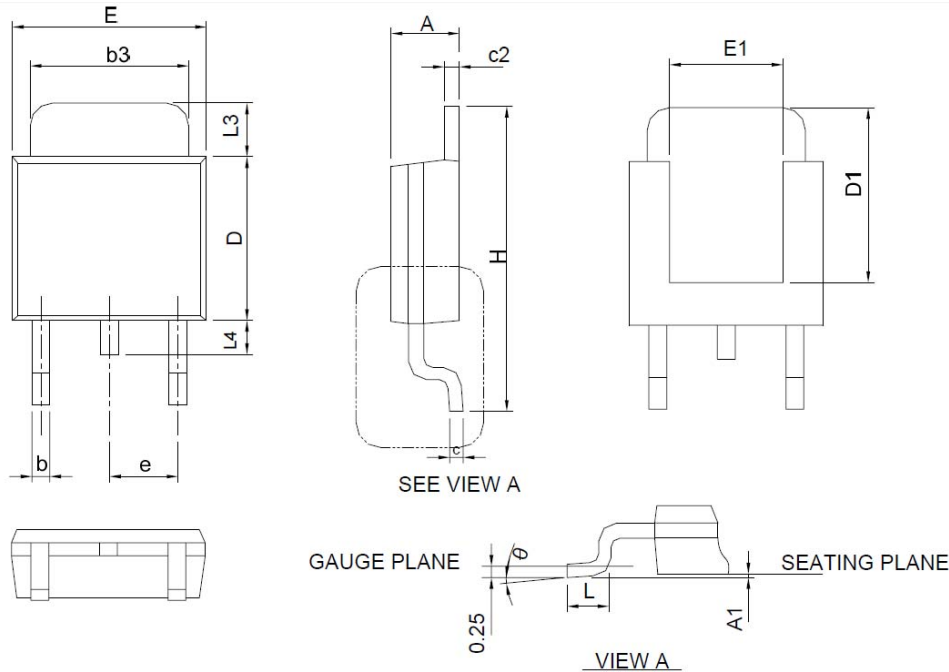

SYMBOL	TO-252-2			
	MILLIMETERS		INCHES	
	MIN.	MAX.	MIN.	MAX.
A	2.18	2.39	0.086	0.094
A1	-	0.13	-	0.005
b	0.50	0.89	0.020	0.035
b3	4.95	5.46	0.195	0.215
c	0.46	0.61	0.018	0.024
c2	0.46	0.89	0.018	0.035
D	5.33	6.22	0.210	0.245
D1	4.57	6.00	0.180	0.236
E	6.35	6.73	0.250	0.265
E1	3.81	6.00	0.150	0.236
e	2.29 BSC		0.090 BSC	
H	9.40	10.41	0.370	0.410
L	0.90	1.78	0.035	0.070
L3	0.89	2.03	0.035	0.080
L4	-	1.02	-	0.040
θ	0°	8°	0°	8°

Note : Follow JEDEC TO-252 .

RECOMMENDED LAND PATTERN

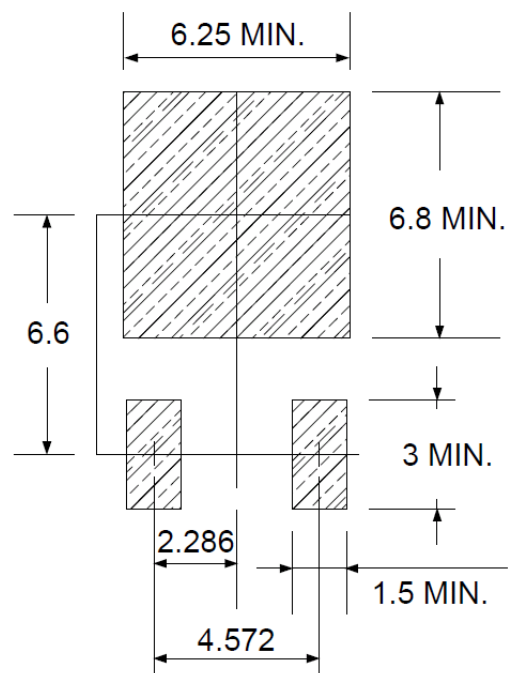

UNIT: mm

Design Notes