

DESCRIPTION

The TDM3424 uses advanced trench technology to provide excellent RDS(ON) and low gate charge .This device is suitable for use as a load switch or in PWM applications.

GENERAL FEATURES

- RDS(ON) < 32mΩ @ VGS=4.5V
RDS(ON) < 23mΩ @ VGS=10V
- High Power and current handling capability
- Lead free product is available
- Surface Mount Package

Application

- PWM applications
- Load switch
- Power management

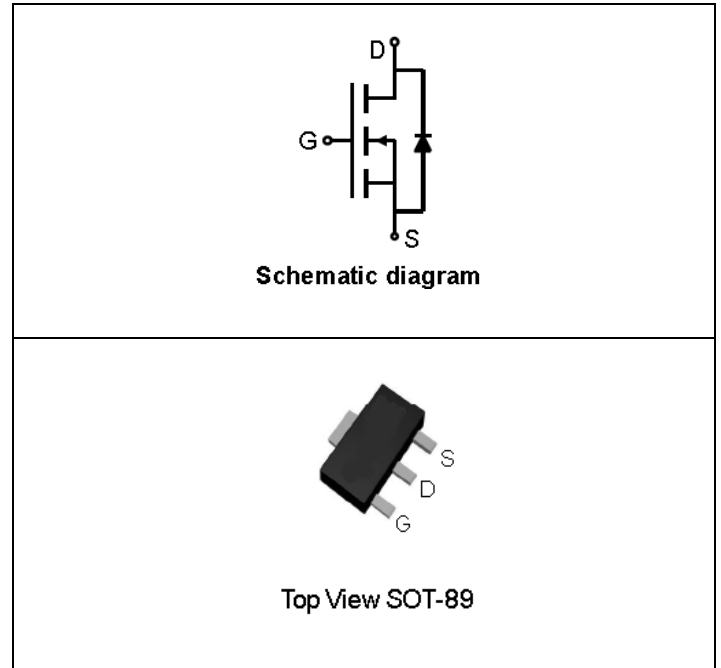

ABSOLUTE MAXIMUM RATINGS(TA=25°C unless otherwise noted)

Parameter	Symbol	Limit	Unit
Drain-Source Voltage	V _{DS}	30	V
Gate-Source Voltage	V _{GS}	±20	V
Drain Current @ Continuous(Note 1)	I _D (25°C)	8	A
	I _D (70°C)	6	A
Drain Current @ Current-Pulsed (Note 1)	I _{DM}	20	A
Maximum Power Dissipation (TA=25°C)	P _D	3.5	W
Operating Junction and Storage Temperature Range	T _J ,T _{STG}	-55 To 150	°C

THERMAL CHARACTERISTICS

Thermal Resistance,Junction-to-Ambient (Note 2)	RθJA	35	°C/W
---	------	----	------

N-Channel Enhancement Mode MOSFET
TDM3424
ELECTRICAL CHARACTERISTICS ($T_A=25^{\circ}\text{C}$ unless otherwise noted)

Parameter	Symbol	Condition	Min	Typ	Max	Unit
OFF CHARACTERISTICS						
Drain-Source Breakdown Voltage	BV_{DSS}	$V_{GS}=0V, I_D=250\mu A$	30			V
Zero Gate Voltage Drain Current	I_{DSS}	$V_{DS}=24V, V_{GS}=0V$			1	μA
Gate-Body Leakage Current	I_{GSS}	$V_{GS}=\pm 20V, V_{DS}=0V$			± 100	nA
ON CHARACTERISTICS (Note 3)						
Gate Threshold Voltage	$V_{GS(th)}$	$V_{DS}=V_{GS}, I_D=250\mu A$	1	1.9	3	V
Drain-Source On-State Resistance	$R_{DS(on)}$	$V_{GS}=4.5V, I_D=5A$		26	32	m Ω
		$V_{GS}=10V, I_D=8A$		20	23	m Ω
DYNAMIC CHARACTERISTICS (Note 4)						
Input Capacitance	C_{iss}	$V_{DS}=15V, V_{GS}=0V, F=1.0MHz$		410		PF
Output Capacitance	C_{oss}			70		PF
Reverse Transfer Capacitance	C_{rss}			40		PF
SWITCHING CHARACTERISTICS (Note 4)						
Turn-on Delay Time	$t_{d(on)}$	$V_{DS}=15V, V_{GS}=10V, R_{GEN}=6\Omega, I_D=1A$		8		nS
Turn-on Rise Time	t_r			9		nS
Turn-Off Delay Time	$t_{d(off)}$			14		nS
Turn-Off Fall Time	t_f			4		nS
Total Gate Charge	Q_g	$V_{DS}=15V, I_D=8A, V_{GS}=4.5V$		3.8		nC
Gate-Source Charge	Q_{gs}			1.3		nC
Gate-Drain Charge	Q_{gd}			1.6		nC
Body Diode Reverse Recovery Time	T_{rr}	$I_F=8A, di/dt=100A/\mu s$		12.8		nS
Body Diode Reverse Recovery Charge	Q_{rr}			3.8		nC
DRAIN-SOURCE DIODE CHARACTERISTICS						
Diode Forward Voltage (Note 3)	V_{SD}	$V_{GS}=0V, I_S=1A$		0.8	1.1	V

NOTES:

1. Repetitive Rating: Pulse width limited by maximum junction temperature.
2. Surface Mounted on 1in2 FR4 Board, $t \leq 10$ sec.
3. Pulse Test: Pulse Width $\leq 300\mu s$, Duty Cycle $\leq 2\%$.
4. Guaranteed by design, not subject to production testing

Typical Operating Characteristics

Power Dissipation

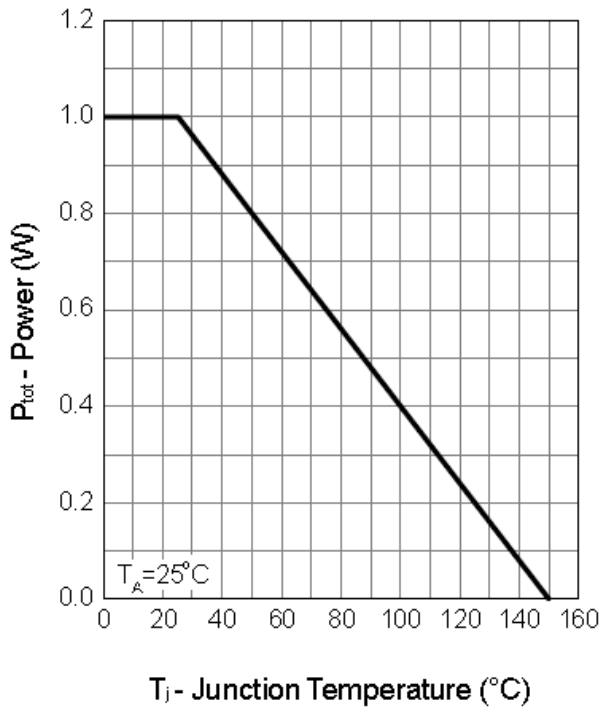

Capacitance

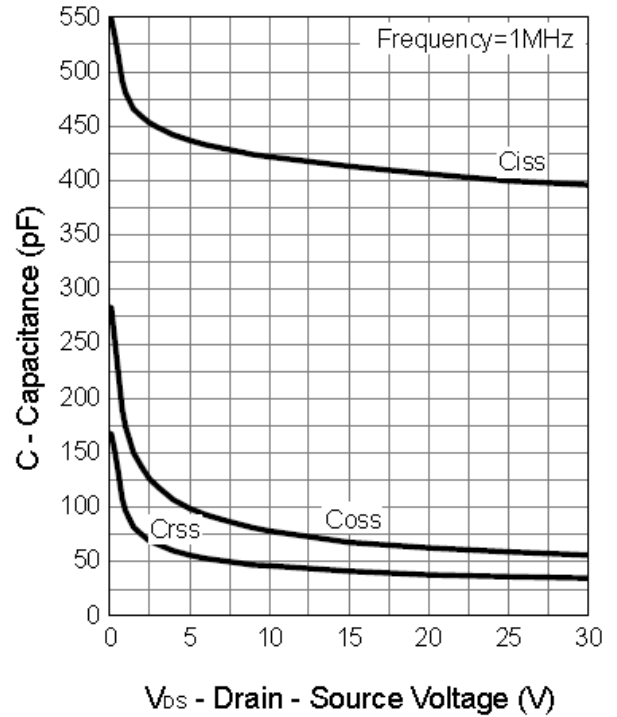

Safe Operation Area

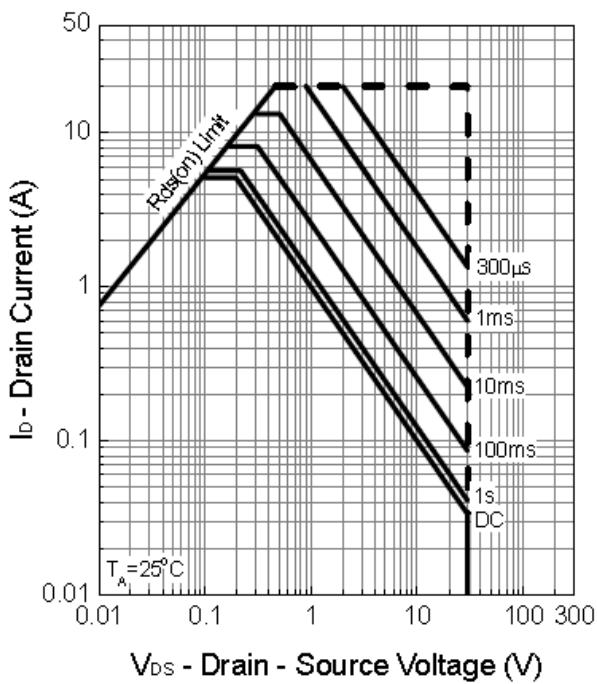

Thermal Transient Impedance

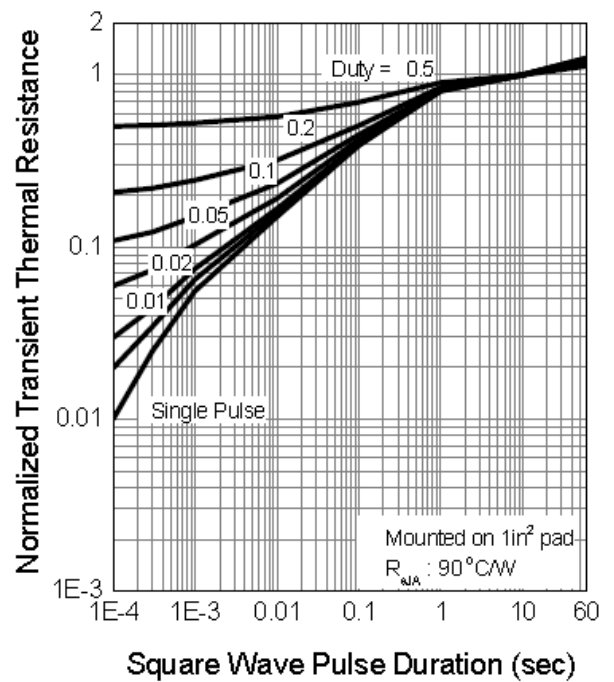

Typical Operating Characteristics(Cont.)

Output Characteristics

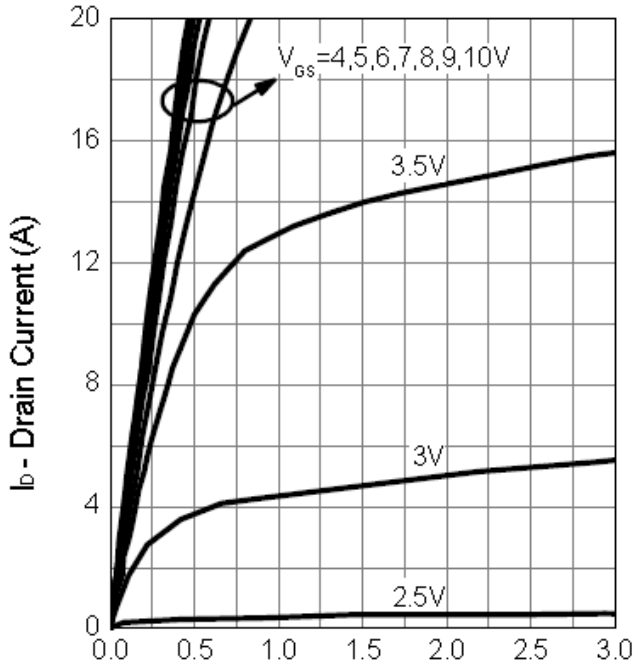

V_{DS} - Drain - Source Voltage (V)

Drain-Source On Resistance

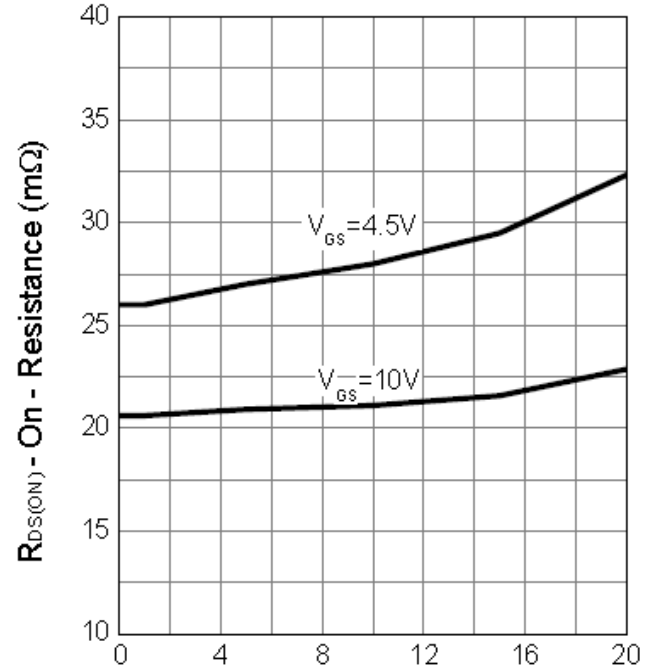

I_D - Drain Current (A)

Gate-Source On Resistance

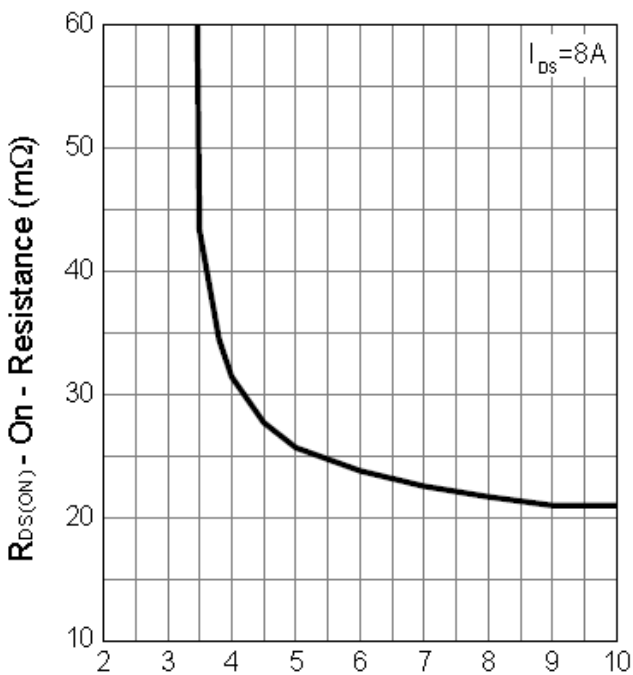

V_{GS} - Gate - Source Voltage (V)

Gate Threshold Voltage

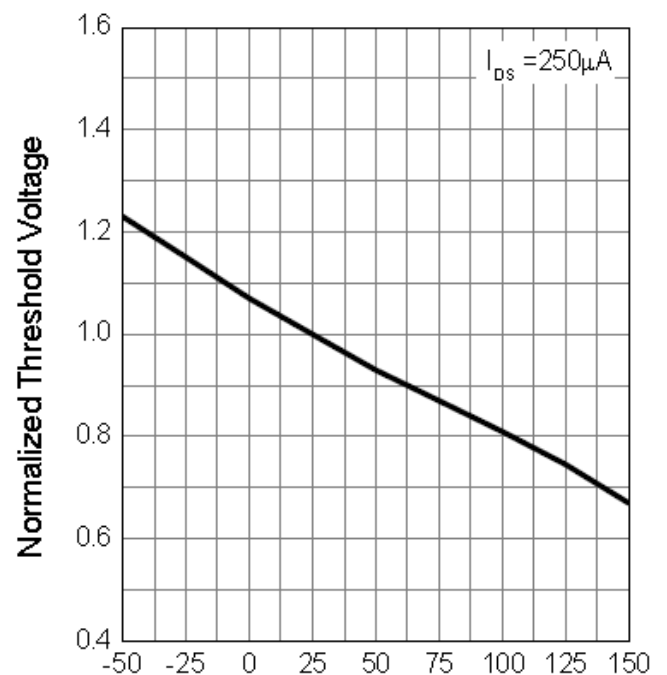

T_J - Junction Temperature ($^{\circ}C$)

Typical Operating Characteristics (Cont.)

Drain-Source On Resistance

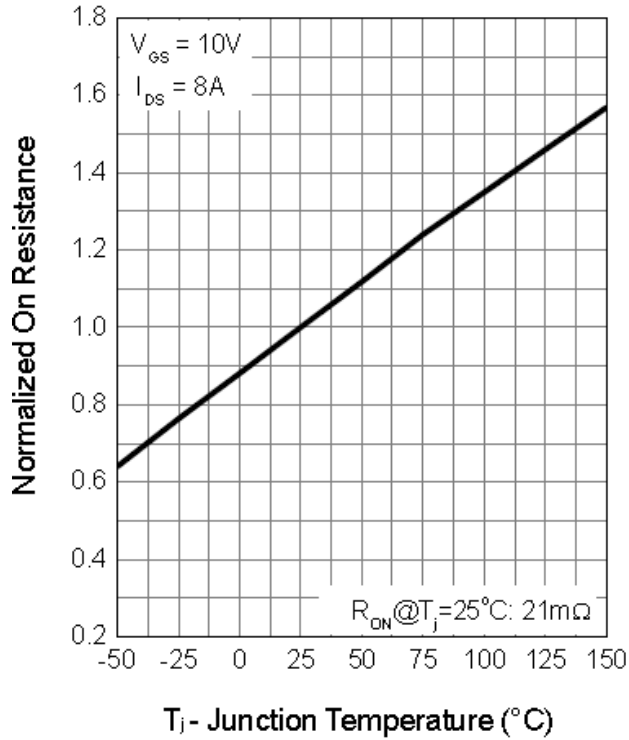

Source-Drain Diode Forward

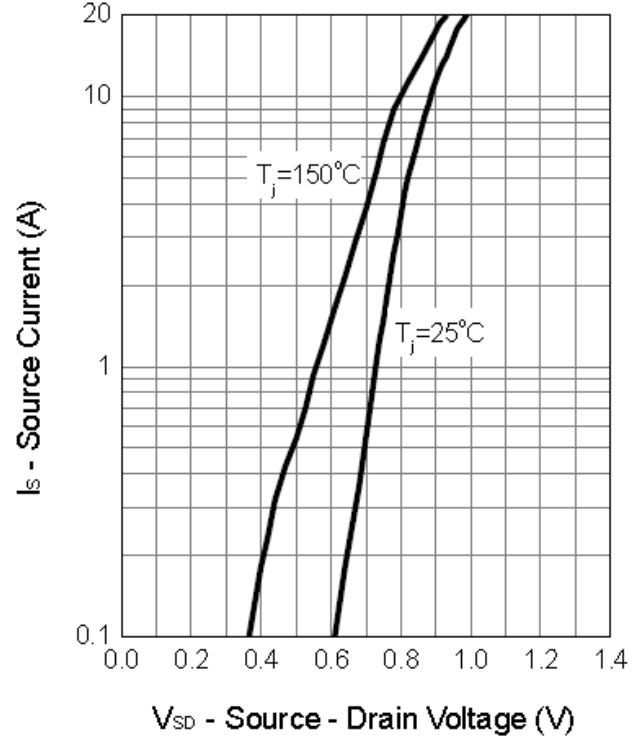

Gate Charge

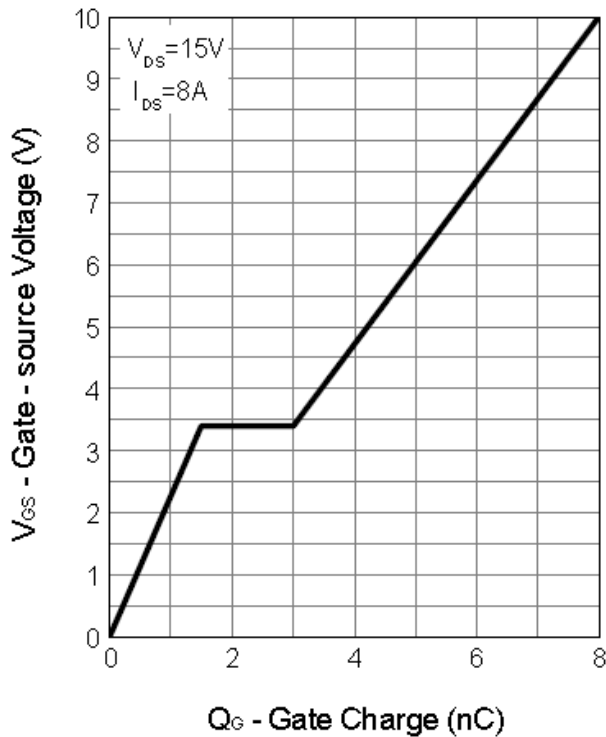

Package Information

SOT89-3 Package

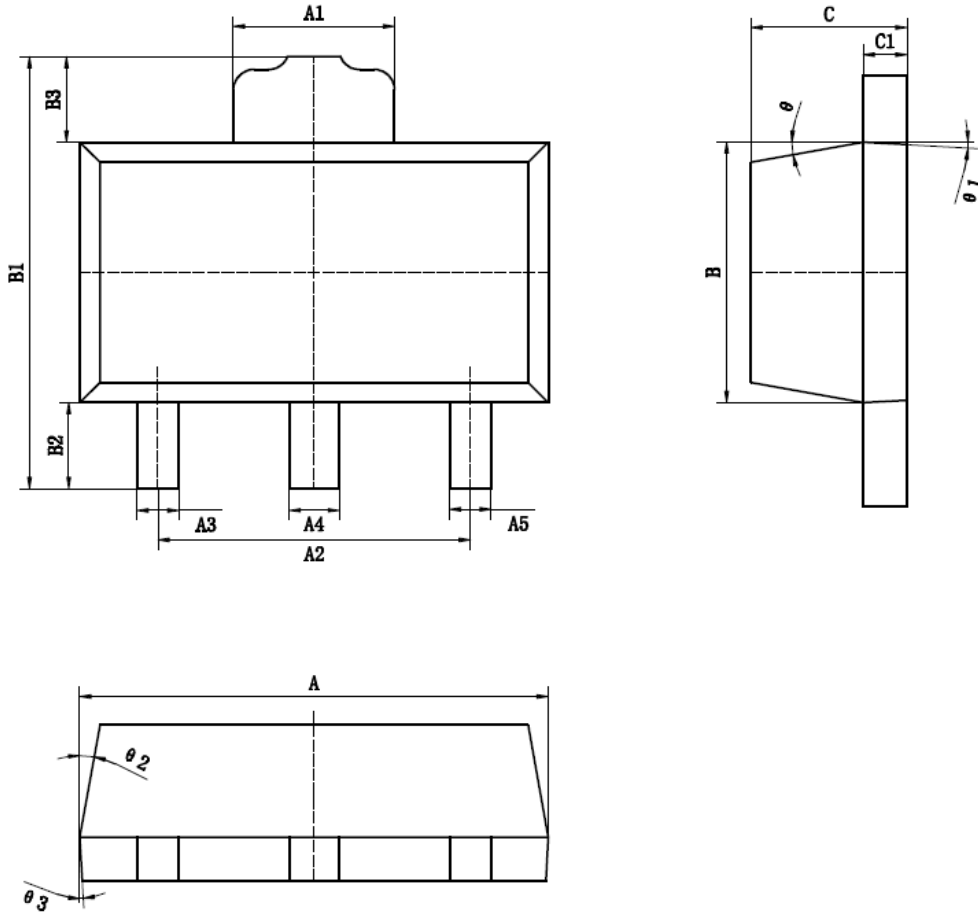

标注	尺寸	最小(mm)	最大(mm)	标注	尺寸	最小(mm)	最大(mm)
A		4.40	4.60	B3		0.82	0.83
A1		1.65	1.75	C		1.40	1.60
A2		2.95	3.05	C1		0.35	0.45
A3		0.35	0.45	θ		6° TYP4	
A4		0.43	0.53	θ 1		3° TYP4	
A5		0.35	0.45	θ 2		6° TYP4	
B		2.40	2.60	θ 3		3° TYP4	
B1		4.05	4.25				
B2		0.82	0.83				

Design Notes