

Dual N-Channel Enhancement Mode MOSFET

TDM3534

DESCRIPTION

The TDM3534 uses advanced trench technology to provide excellent RDS(ON) and low gate charge. This device is suitable for use as a load switch or in PWM applications.

GENERAL FEATURES

- RDS(ON) < 16mΩ @ VGS=4.5V
RDS(ON) < 10mΩ @ VGS=10V
- High Power and current handling capability
- ESD protection
- Lead free product is available
- Surface Mount Package

Application

- PWM applications
- Load switch
- Power management

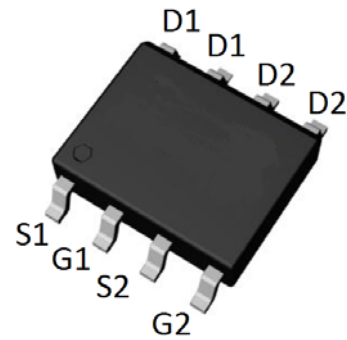
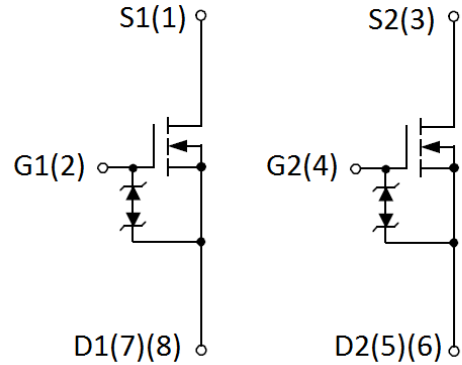

Top view of SOP-8

ABSOLUTE MAXIMUM RATINGS(T_A=25°C unless otherwise noted)

Parameter	Symbol	Channel 1	Channel 2	Unit
Drain-Source Voltage	V _{DS}	30	30	V
Gate-Source Voltage	V _{GS}	±20	±20	V
Diode Continuous Forward Current	I _S (T _C =25°C)	5	5	A
Continuous Drain Current ^(note1)	I _D (T _C =25°C)	18	18	A
Pulse Drain Current Tested ^(note4)	I _{DP} (T _C =25°C)	45	45	A
Maximum Power Dissipation	P _D (T _C =25°C)	20	20	W
Continuous Drain Current	I _D (T _A =25°C)	9.1	9.1	A
	I _D (T _A =70°C)	7.3	7.3	
Pulse Drain Current Tested	I _{DP} (T _A =25°C)	36	36	A
Maximum Power Dissipation	P _D (T _A =25°C)	1.13	1.13	W
Thermal Resistance-Junction to Ambient ^(note 5)	R _{θJA} (t≤10s)	35	35	°C/W
	R _{θJA} (Steady State)	70	70	
Maximum Operating Junction Temperature	T _J	150		°C
Storage Temperature Range	T _{STG}	-55 To 150		°C

ELECTRICAL CHARACTERISTICS Cont. ($T_A=25^{\circ}\text{C}$ unless otherwise noted)

Parameter	Symbol	Test Conditions	Min	Typ	Max	Unit
OFF CHARACTERISTICS						
Drain-Source Breakdown Voltage	BV_{DSS}	$V_{GS}=0V, I_D=250\mu A$	30	-	-	V
Zero Gate Voltage Drain Current	I_{DSS}	$V_{DS}=24V, V_{GS}=0V$	-	-	1	μA
Gate-Body Leakage Current	I_{GSS}	$V_{GS}=\pm 20V, V_{DS}=0V$	-	-	± 10	μA
ON CHARACTERISTICS (Note 2)						
Gate Threshold Voltage	$V_{GS(th)}$	$V_{DS}=V_{GS}, I_D=250\mu A$	1.4	1.8	2.5	V
Drain-Source On-State Resistance	$R_{DS(on)}$	$V_{GS}=10V, I_D=10A$	-	8.2	10	m Ω
		$V_{GS}=4.5V, I_D=8A$	-	12.3	16	m Ω
DYNAMIC CHARACTERISTICS (Note 3)						
Gate Resistance	R_G	$V_{GS}=0V, V_{DS}=0V, F=1MHz$	-	1.35	2.5	Ω
Input Capacitance	C_{iss}	$V_{DS}=15V, V_{GS}=0V, F=1.0MHz$	-	450	600	PF
Output Capacitance	C_{oss}		-	318	-	PF
Reverse Transfer Capacitance	C_{rss}		-	22	-	PF
SWITCHING CHARACTERISTICS (Note 3)						
Turn-on Delay Time	$t_{d(on)}$	$V_{DS}=15V, R_L=15\Omega, V_{GEN}=10V,$ $R_G=6\Omega, I_D=1A$	-	8.5	16	nS
Turn-on Rise Time	t_r		-	10	18	nS
Turn-Off Delay Time	$t_{d(off)}$		-	14	26	nS
Turn-Off Fall Time	t_f		-	10.6	19	nS
Total Gate Charge	Q_g	$V_{DS}=15V, I_D=10A, V_{GS}=10V$	-	8	12	nC
Gate-Source Charge	Q_{gs}		-	1.6	-	nC
Gate-Drain Charge	Q_{gd}		-	1.2	-	nC
Body Diode Reverse Recovery Time	T_{rr}	$I_{DS}=10A, di/dt=100A/\mu s$	-	20.5	-	nS
Body Diode Reverse Recovery Charge	Q_{rr}		-	7.2	-	nC
DRAIN-SOURCE DIODE CHARACTERISTICS						
Diode Forward Voltage (Note 2)	V_{SD}	$V_{GS}=0V, I_S=5A$	-	0.8	1.1	V

NOTES:

1. Max continuous current is limited by bonding wire.
2. Pulse Test: Pulse Width $\leq 300\mu s$, Duty Cycle $\leq 2\%$.
3. Guaranteed by design, not subject to production testing.
4. Pulse width is limited by max. junction temperature.
5. $R_{\theta JA}$ steady state $t=999s$

Dual N-Channel Enhancement Mode MOSFET TDM3534

Channel 1 and Channel 2 Typical Operating Characteristics

Power Dissipation

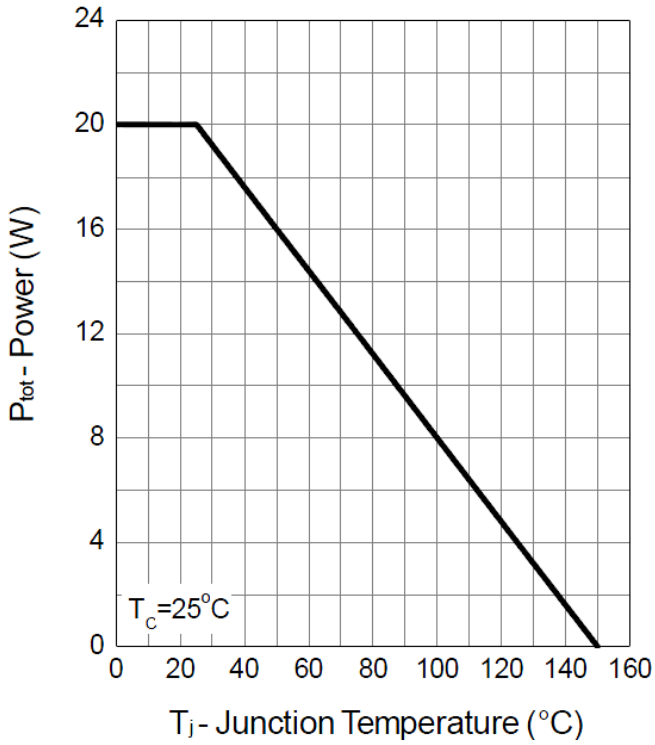

Drain Current

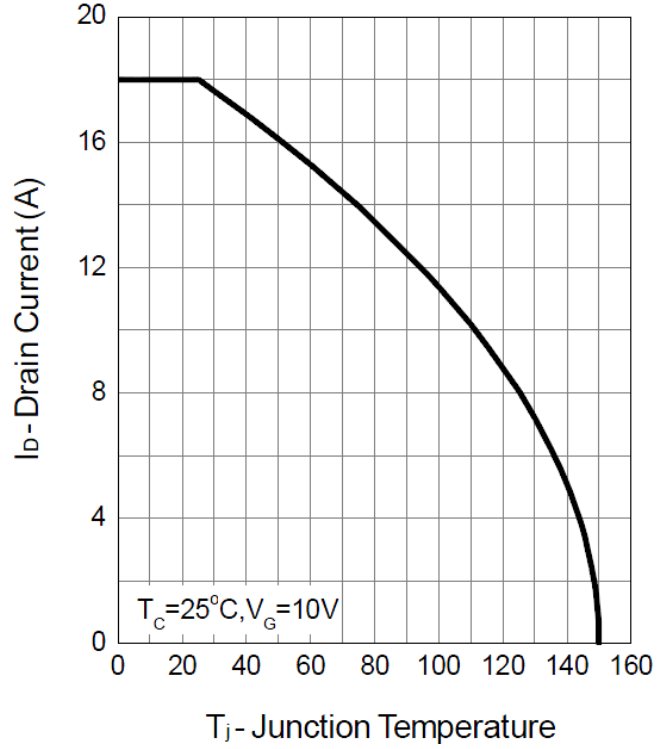

Safe Operation Area

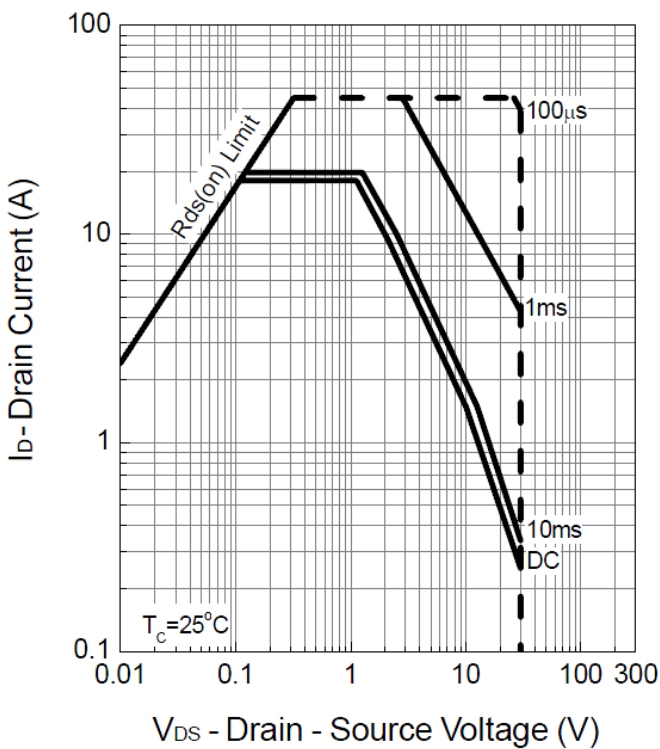

Thermal Transient Impedance

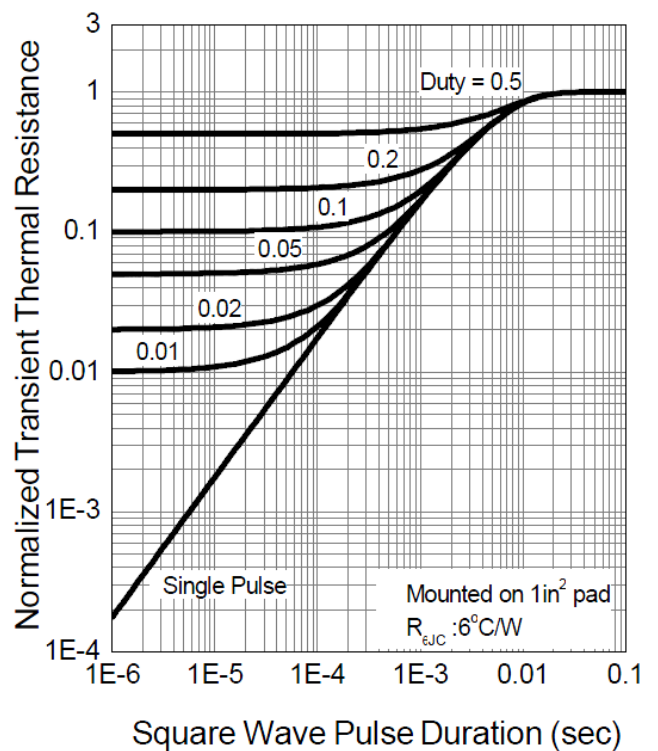

Dual N-Channel Enhancement Mode MOSFET TDM3534

Channel 2 Typical Operating Characteristics (Cont.)

Safe Operation Area

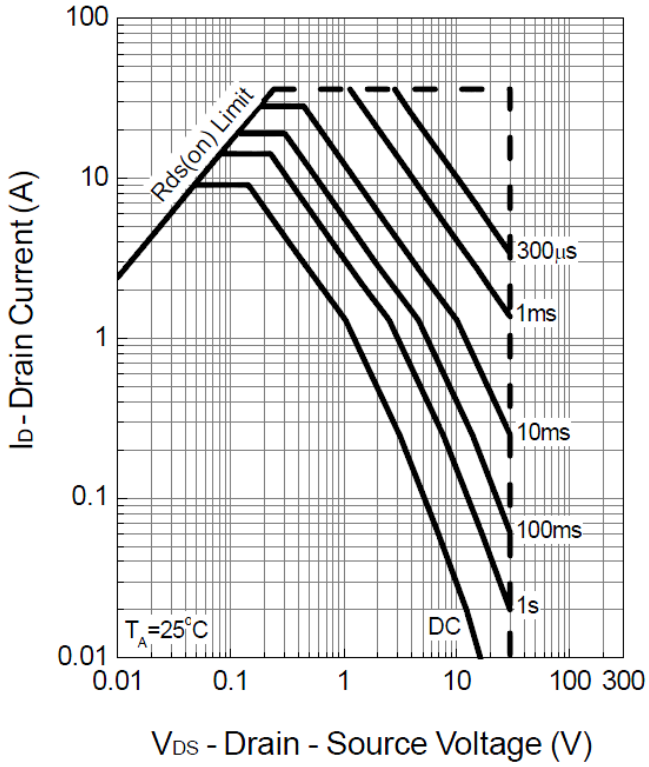

Thermal Transient Impedance

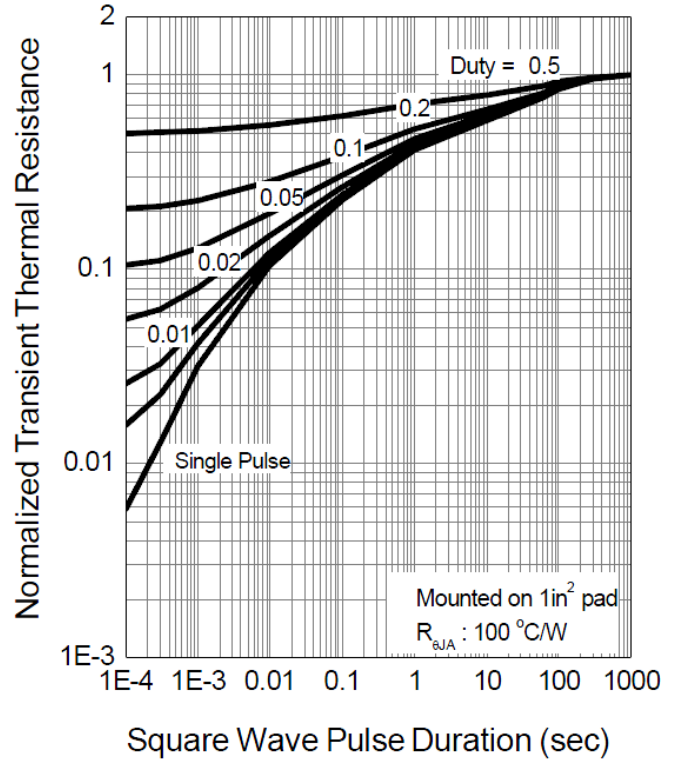

Output Characteristics

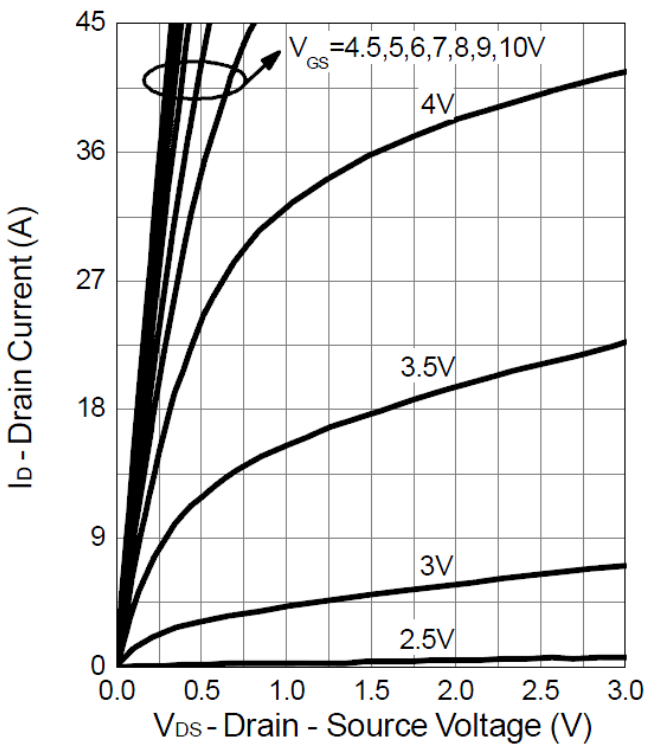

Drain-Source On Resistance

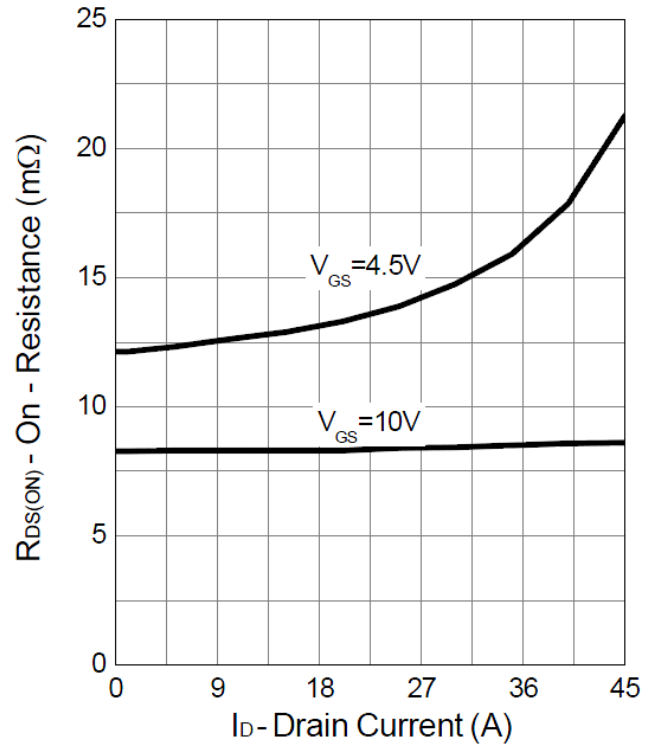

Dual N-Channel Enhancement Mode MOSFET TDM3534

Channel 2 Typical Operating Characteristics (Cont.)

Gate-Source On Resistance

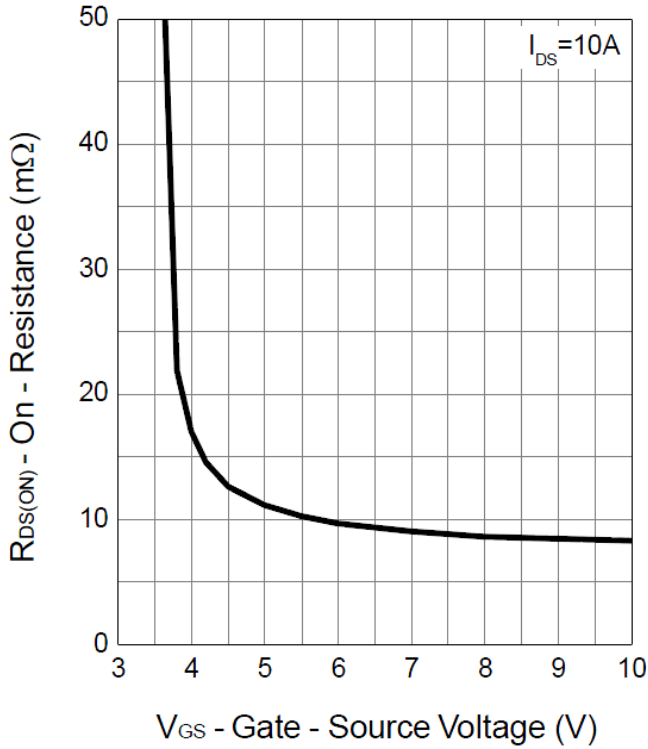

Gate Threshold Voltage

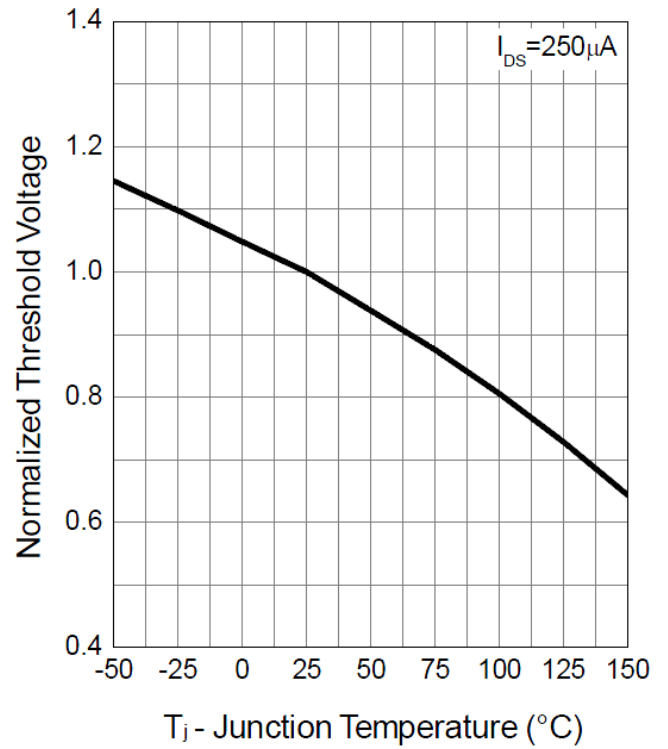

Drain-Source On Resistance

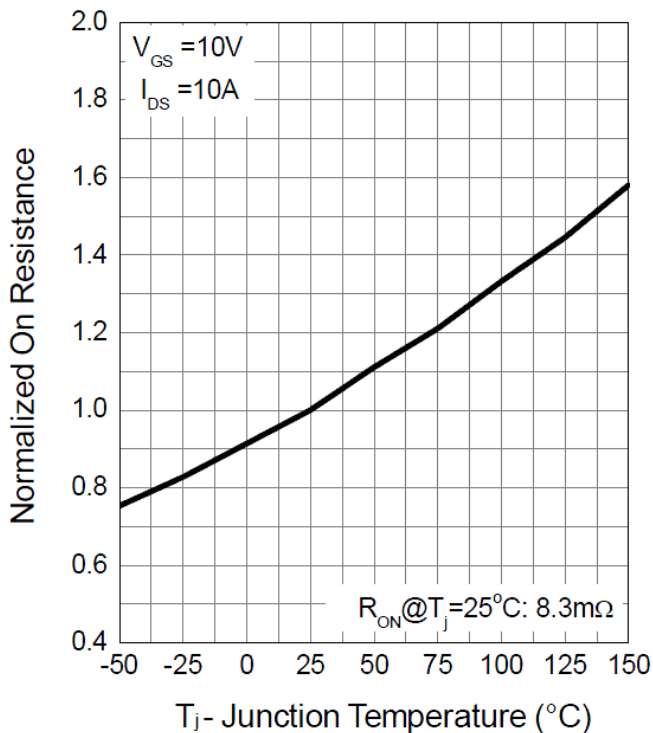

Source-Drain Diode Forward

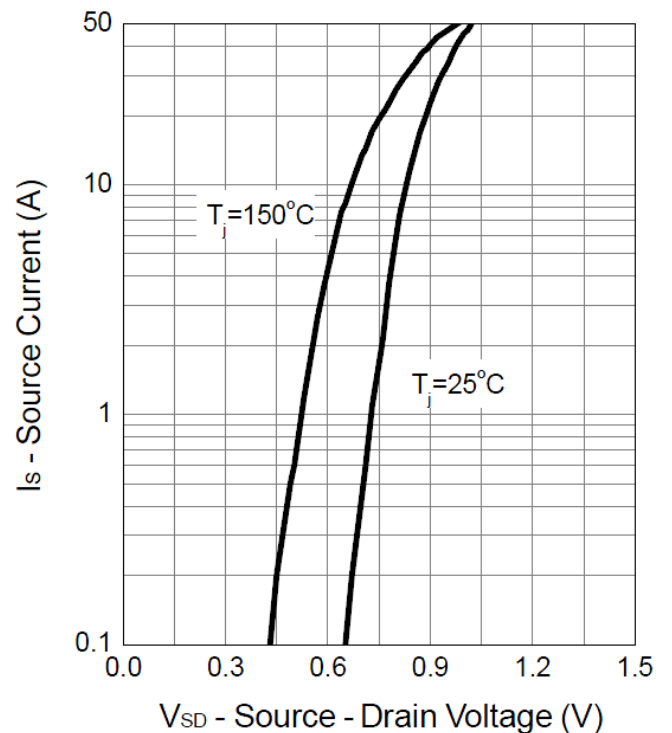

Channel 2 Typical Operating Characteristics (Cont.)

Capacitance

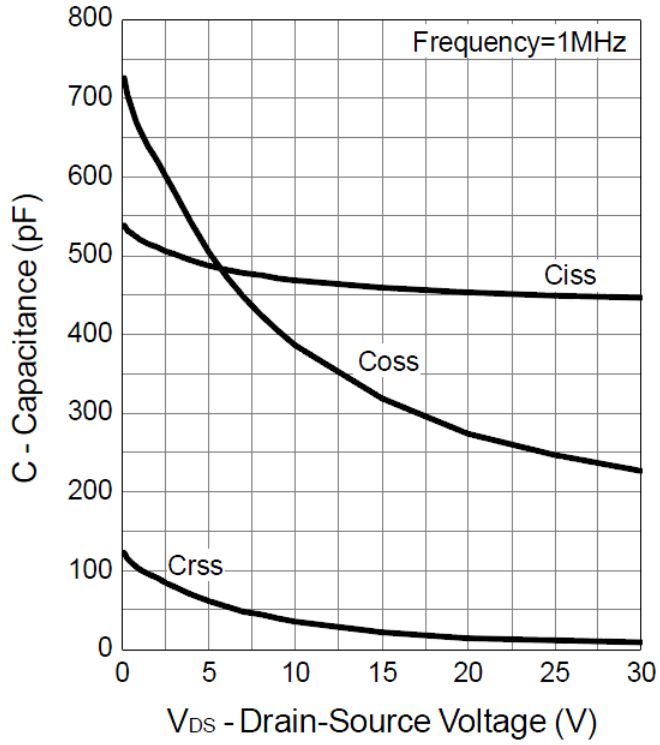

Gate Charge

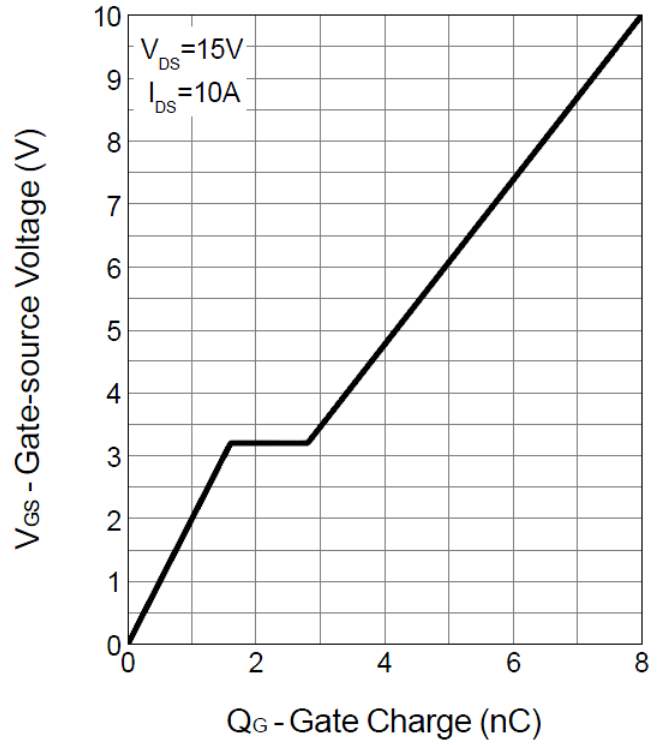

Package Information

SOP-8 Package

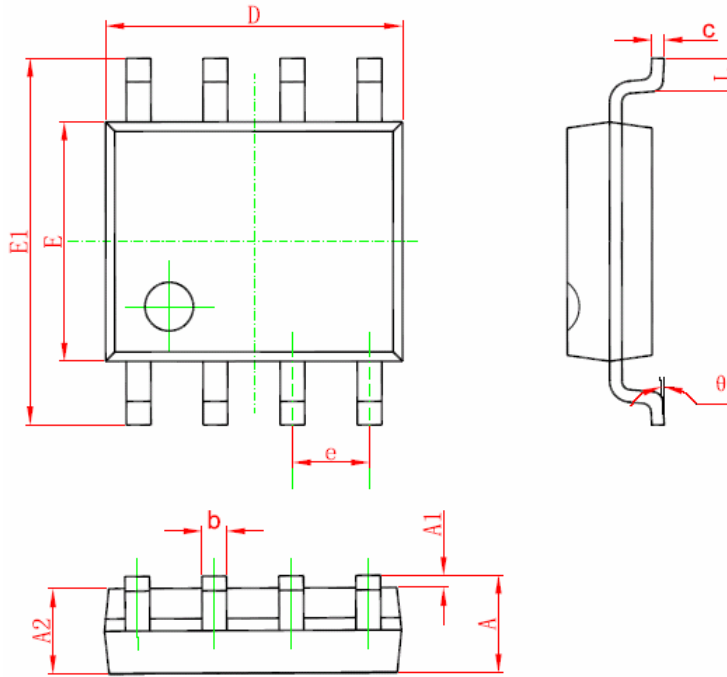

Symbol	Dimensions In Millimeters		Dimensions In Inches	
	Min	Max	Min	Max
A	1.350	1.750	0.053	0.069
A1	0.100	0.250	0.004	0.010
A2	1.350	1.550	0.053	0.061
b	0.330	0.510	0.013	0.020
c	0.170	0.250	0.006	0.010
D	4.700	5.100	0.185	0.200
E	3.800	4.000	0.150	0.157
E1	5.800	6.200	0.228	0.244
e	1.270 (BSC)		0.050 (BSC)	
L	0.400	1.270	0.016	0.050
θ	0°	8°	0°	8°

Design Notes