

78C 07320 D

THOMSON SEMICONDUCTORS

TEA2021

T-74-05-01

7 W AUDIO AMPLIFIER

The TEA2021 is a monolithic integrated circuit designed for class B audio amplification, with up to 7 W output power : it is internally protected against overheating.

It provides the advantages following :

- The idling current stability obtained from a built-in temperature and voltage-compensating network makes thermal runaway impossible
- High open-loop gain.
- The use of PNP transistors in the preamplifier allows DC input voltage to be zero.
- Others highlights include : few external components
 . simple heatsinking
 . space and cost saving.

- High output power : 7 W at $V_{CC} = 16 \text{ V}$, $R_L = 4 \Omega$
- Low noise
- High supply voltage ripple rejection
- Load dump protection up to 40 V

The circuit is protected against overheating, output short-circuits ($V_{CC} = 15 \text{ V}$), polarity inversion and fortuitous open ground.

7 W AUDIO AMPLIFIER

CASE CB-313

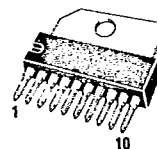

SP SUFFIX
PLASTIC PACKAGE

SCHEMATIC

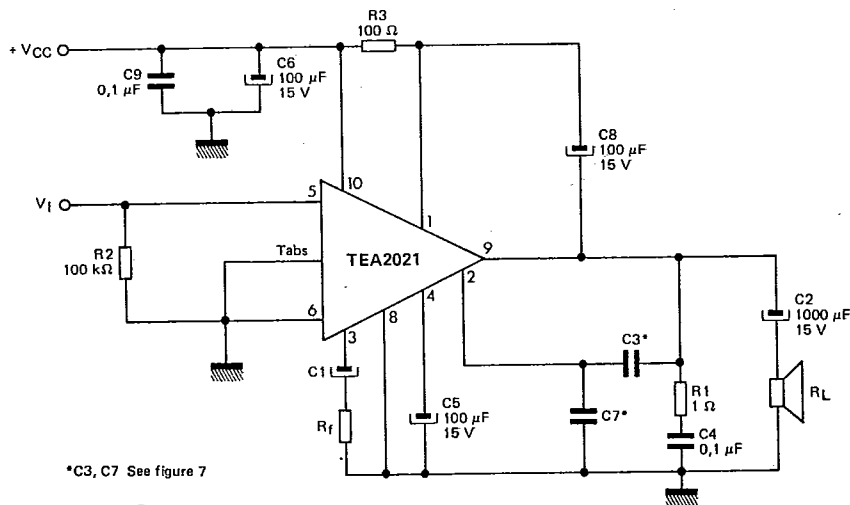

*C3, C7 See figure 7

THOMSON SEMICONDUCTORS
Sales headquarters
45, av. de l'Europe - 78140 VELIZY - FRANCE
Tel. : (3) 946 97 19 / Telex : 204780 F

539

THOMSON
COMPONENTS

NT8318-A

TEA2021

T-74-05-01

MAXIMUM RATINGS

Rating	Symbol	Value	Unit
Peak supply voltage (50 ms)	V _{CC}	40	V
DC supply voltage	V _{CC}	28	V
Supply voltage	V _{CC}	20	V
Peak output current (non repetitive)	I _O	4	A
Peak output current (repetitive)	I _O	3	A
Junction temperature	T _J	- 40, + 150	°C
Storage temperature	T _{stg}	- 40, + 150	°C

THERMAL CHARACTERISTICS

Characteristic	Symbol	Value	Unit
Junction-case thermal resistance	R _{th(j-c)}	10	°C/W
Junction ambient thermal resistance	R _{th(j-a)}	55	°C/W

PIN CONFIGURATION

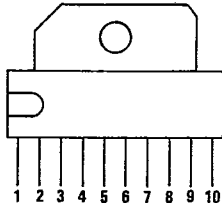

1	Bootstrap
2	Compensation
3	Feed-back network
4	Ripple rejection
5	Input

6	Pre-amplifier ground and substrate
7	No to be used
8	Output stage ground
9	Output
10	Supply voltage V _{CC}

ELECTRICAL DIAGRAM

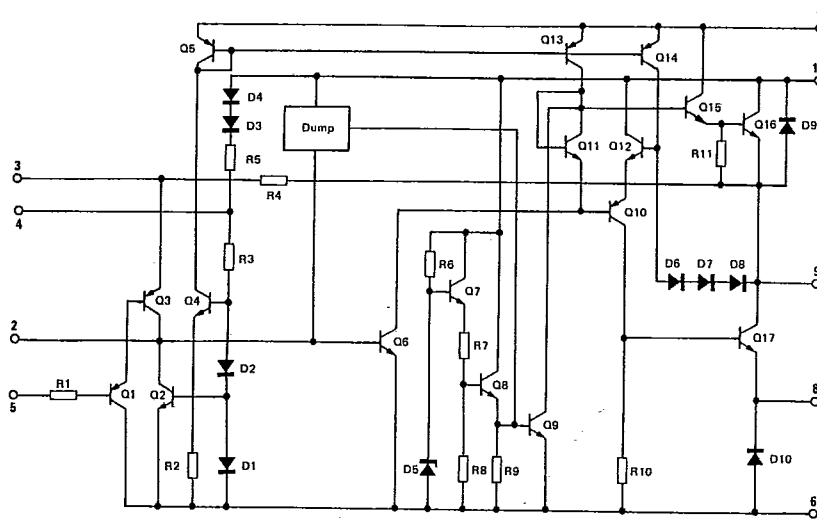

78C 07322 D

TEA2021

ELECTRICAL CHARACTERISTICS

 $T_{amb} = +25^{\circ}\text{C}$ Note 1 $V_{CC} = 14.4\text{ V}$ (Unless otherwise specified)

T.74.05.01

Characteristic	Symbol	Min	Typ	Max	Unit
Supply voltage Pin 10	V_{CC}	4	—	20	V
Quiescent output voltage ($V_{CC} = 14.4\text{ V}$) Pin 9	V_O	6.4	7.2	8	V
Quiescent current ($V_{CC} = 14.4\text{ V}$) Pin 10	I_{CC}	—	12	20	mA
Bias current ($V_{CC} = 14.4\text{ V}$) Pin 5	I_B	—	0.4	—	μA
Output power ($d = 10\%$; $f = 1\text{ KHz}$) $V_{CC} = 14.4\text{ V}$; $R_L = 4\ \Omega$ $V_{CC} = 13.2\text{ V}$; $R_L = 3.2\ \Omega$	P_O	5.5 —	6 5.8	— —	W
Input voltage saturation (sine wave)	$V_{I_{rms}}$	220	—	—	mV
Sensitivity ($f = 1\text{ KHz}$) $P_O = 6\text{ W}$; $V_{CC} = 14.4\text{ V}$; $R_L = 4\ \Omega$; $R_f = 56\ \Omega$ $P_O = 6\text{ W}$; $V_{CC} = 14.4\text{ V}$; $R_L = 4\ \Omega$; $R_f = 22\ \Omega$ $P_O = 5.8\text{ W}$; $V_{CC} = 13.2\text{ V}$; $R_L = 3.2\ \Omega$; $R_f = 56\ \Omega$ $P_O = 5.8\text{ W}$; $V_{CC} = 13.2\text{ V}$; $R_L = 3.2\ \Omega$; $R_f = 10\ \Omega$	S	— — — —	75 30 60 12	— — — —	mV
Input resistance Pin 5	Z_I	—	5	—	M Ω
Frequency response (-3 dB), ($V_{CC} = 14.4\text{ V}$; $R_L = 4\ \Omega$; $R_f = 56\ \Omega$) $C_3 = 820\text{ pF}$ $C_3 = 1500\text{ pF}$	B		40 - 20 000 40 - 10 000		Hz
Distortion ($V_{CC} = 14.4\text{ V}$; $P_O = 50\text{ mW} = 2.5\text{ W}$; $R_L = 4\ \Omega$; $f = 1\text{ KHz}$)	d	—	0.3	—	%
Voltage gain (open loop) ($V_{CC} = 14.4\text{ V}$; $R_L = 4\ \Omega$; $f = 1\text{ KHz}$)	A_V	—	80	—	dB
Voltage gain (closed loop) $V_{CC} = 14.4\text{ V}$; $R_L = 4\ \Omega$; $f = 1\text{ KHz}$; $R_f = 56\ \Omega$	A_V	34	37	40	dB
Input noise voltage ($V_{CC} = 16\text{ V}$; $B(-3\text{ dB}) = 40 - 15\ 000\text{ Hz}$)	v_n	—	2	—	μV
Input noise current ($V_{CC} = 16\text{ V}$; $B(-3\text{ dB}) = 40 - 15\ 000\text{ Hz}$)	i_n	—	80	—	pA
Efficiency ($V_{CC} = 14.4\text{ V}$; $P_O = 6\text{ W}$; $R_L = 4\ \Omega$; $f = 1\text{ KHz}$)	η	—	67	—	%
Supply voltage rejection $V_{CC} = 14.4\text{ V}$; $R_L = 4\ \Omega$; $V_{ripple} = 1\text{ V}_{rms}$; $f = 100\text{ Hz}$; $A_V = 37\text{ dB}$; $C_5 = 100\ \mu\text{F}$	SVR	40	48	—	dB

Note 1 : The characteristics above were obtained using the circuit shown in figure 1.

3/8

541

TYPICAL QUIESCENT CURRENT VERSUS SUPPLY VOLTAGE

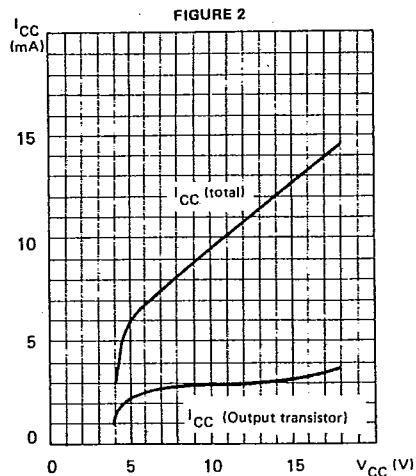

TYPICAL QUIESCENT OUTPUT VOLTAGE (pin 8) VERSUS SUPPLY VOLTAGE

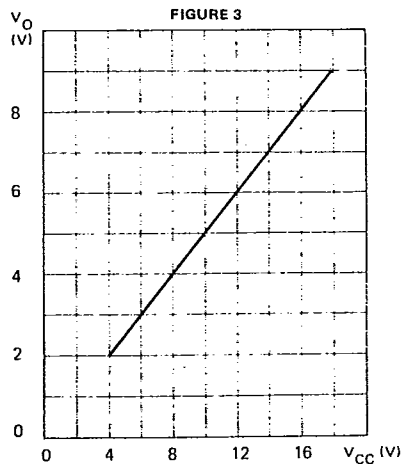

TYPICAL POWER OUTPUT VERSUS SUPPLY VOLTAGE

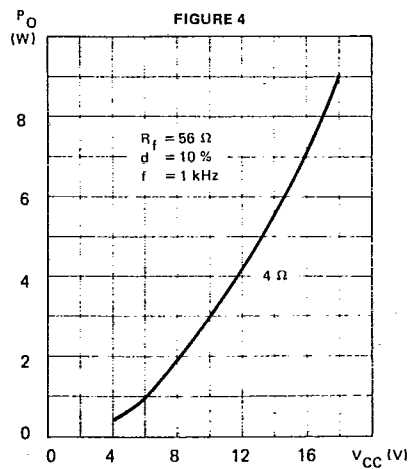

TYPICAL DISTORTION VERSUS FREQUENCY

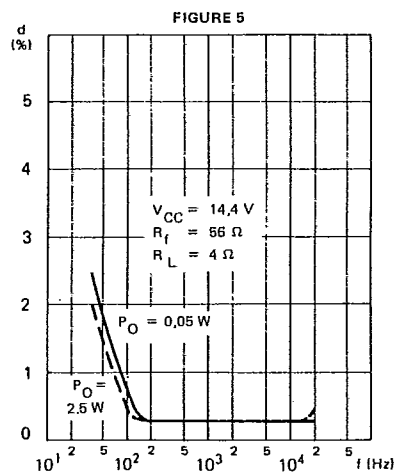

T-74-05-01

TYPICAL DISTORTION VERSUS OUTPUT POWER

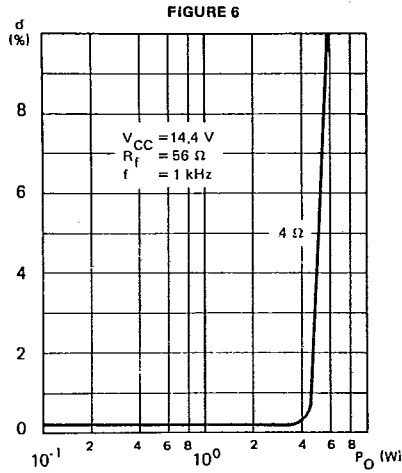

TYPICAL RELATIVE VOLTAGE GAIN (CLOSED LOOP) AND TYPICAL INPUT VOLTAGE VERSUS FEEDBACK RESISTANCE (R_f)

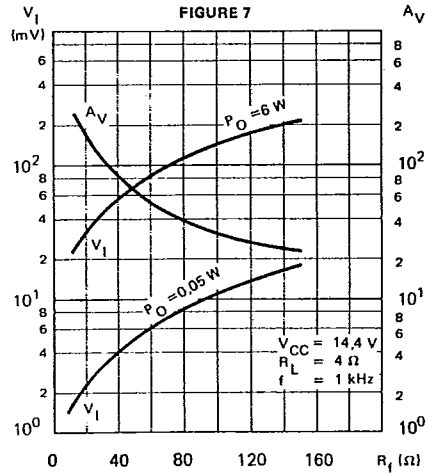

TYPICAL VALUES OF C_3 VERSUS R_f FOR VARIOUS VALUES OF B

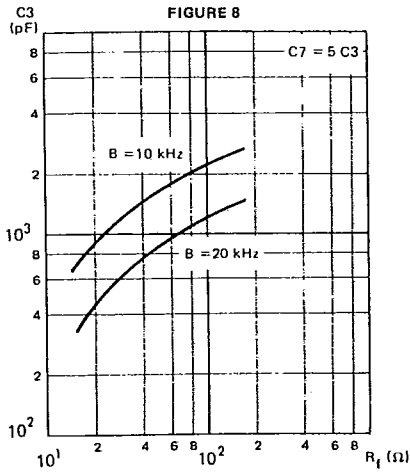

TYPICAL SUPPLY VOLTAGE REJECTION RATIO VERSUS FEEDBACK RESISTANCE

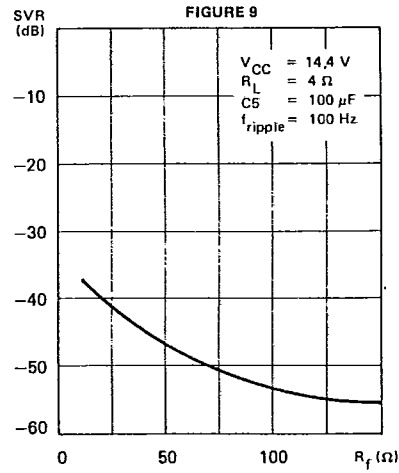

MAXIMUM POWER DISSIPATION VERSUS SUPPLY VOLTAGE (Sine wave operation)

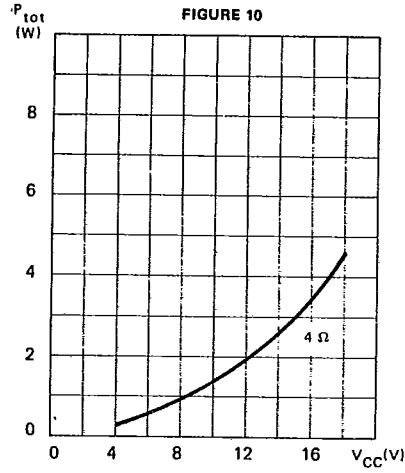

TYPICAL POWER DISSIPATION AND EFFICIENCY VERSUS OUTPUT POWER

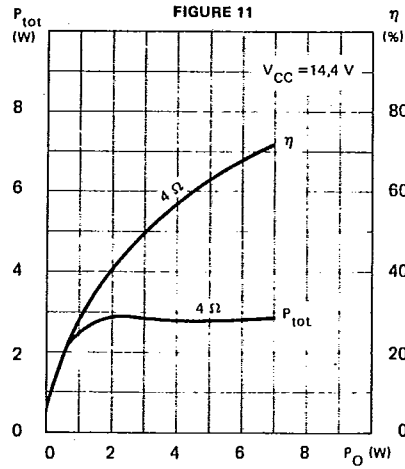

TEST AND APPLICATION CIRCUIT

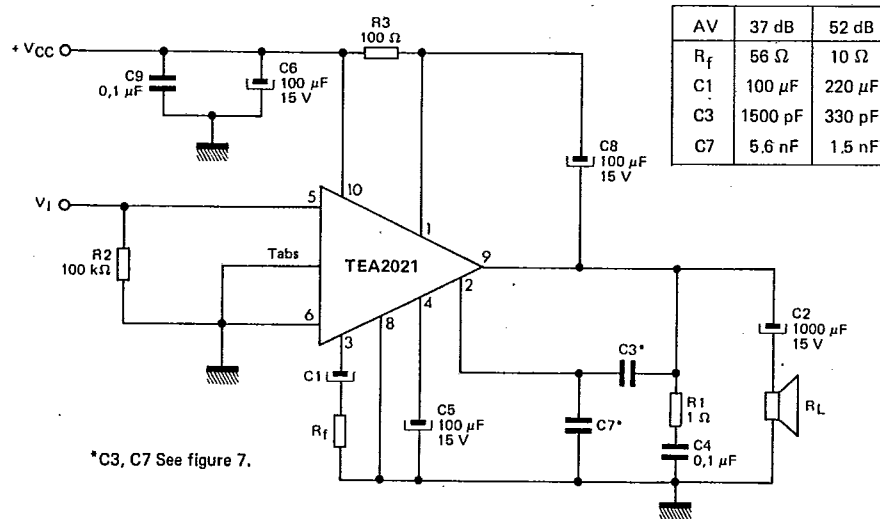

78C 07326 D

TEA2021

T-74-05-01

BUILT-IN PROTECTION SYSTEMS**Load dump protection**

The load dump case occurs in a car when the engine is running and the battery is disconnected: voltage spikes on the power line are supplied by the alternator since there is no clamping effect due to battery capacitance.

The TEA2021 was designed to withstand a pulse train on pin 10, of the type shown in fig. 12. Providing an LC filter is included, as shown in fig. 13, a much higher pulse train amplitude (up to 100 V peak) is allowed on the supply line with no damage to the device.

Short-circuit protection

The TEA2021 can withstand a permanent short-circuit across the load for a supply voltage up to 15 V.

Polarity inversion protection

High current (up to 5 A) can be handled by the device with no damage for a longer period than the blow-out time of a quick 1 A fuse (normally connected in series with the supply). This feature is added to avoid destruction if, during fitting to the car, a mistake on the connection of the supply is made.

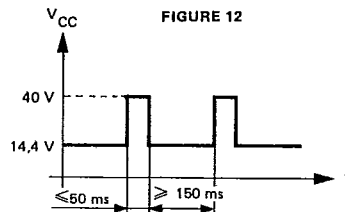
**Open ground protection**

When the radio is in the ON condition and the ground is accidentally opened, a standard audio amplifier will be damaged. On the TEA2021, protection diodes are included to avoid any damage.

Inductive load protection

A protection diode is provided between pins 9 and 10 (see the internal schematic diagram) the allow used of the TEA 2021 with inductive loads.

In particular, the TEA2021 can drive the coupling transformer for audio modulation in CB transmitters.

DC voltage protection

The maximum operating DC voltage on the TEA2021 is 20 V.

However the device can withstand a DC voltage up to 28 V with no damage. This could occur during winter if two batteries were series connected to crank the engine.

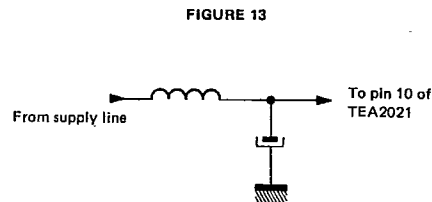

7/8

545

TEA2021

T-74-05-01

OUTPUT POWER AND SUPPLY CURRENT VERSUS PACKAGE TEMPERATURE

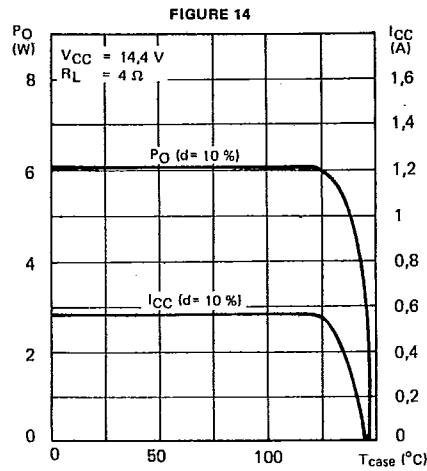

MAXIMUM POWER DISSIPATION

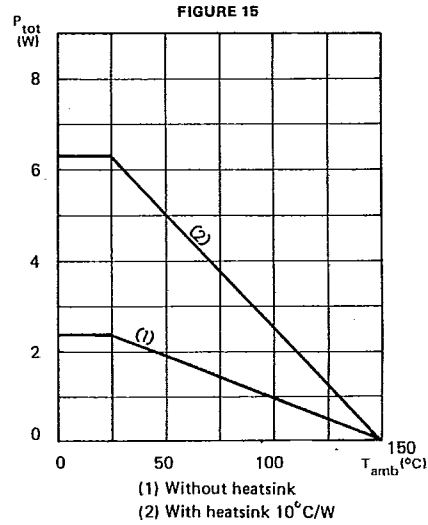

THERMAL PROTECTION

A thermal limiting circuit is internally provided on TEA 2021 to prevent chip temperature exceeding 150°C . This protection offers the following advantages :

1 - An overload on the output (even of permanent), or an above-limit ambient temperature can be withstood.

2 - The heatsink can be designed with smaller safety margins compared with that of a conventional power audio amplifier.

The TEA2021 will remain undamaged in the event of excessive junction temperature : all that happens is that P_O (and therefore P_{tot}) are reduced (fig. 14).

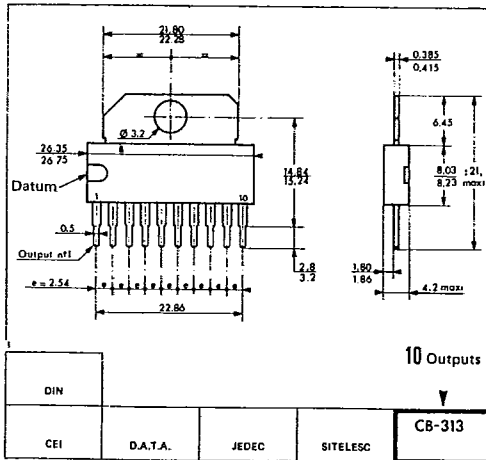

CASE CB-313

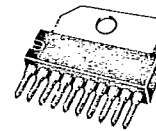

SP SUFFIX
PLASTIC PACKAGE

These specifications are subject to change without notice.
Please inquire with our sales offices about the availability of the different packages.