

# DATA SHEET



## **TEA5768HL**

Low-power FM stereo radio for  
handheld applications

Product specification  
Supersedes data of 2003 Nov 06

2004 Sep 13

# Low-power FM stereo radio for handheld applications

## TEA5768HL

<b>CONTENTS</b>	9	<b>LIMITING VALUES</b>
1	10	THERMAL CHARACTERISTICS
2	11	DC CHARACTERISTICS
3	12	AC CHARACTERISTICS
4	13	INTERNAL PIN CONFIGURATION
5	14	APPLICATION INFORMATION
6	15	PACKAGE OUTLINE
7	16	SOLDERING
7.1	16.1	Introduction to soldering surface mount packages
7.2	16.2	Reflow soldering
7.3	16.3	Wave soldering
7.4	16.4	Manual soldering
7.5	16.5	Suitability of surface mount IC packages for wave and reflow soldering methods
7.6		
7.7		
7.8	17	DATA SHEET STATUS
7.9	18	DEFINITIONS
7.10	19	DISCLAIMERS
7.11	20	PURCHASE OF PHILIPS I <sup>2</sup> C COMPONENTS
7.12		
7.13		
7.14		
7.15		
8		
8.1		
8.1.1		
8.1.2		
8.2		
8.3		
8.4		
8.5		

# Low-power FM stereo radio for handheld applications

TEA5768HL

## 1 FEATURES

- High sensitivity due to integrated low-noise RF input amplifier
- FM mixer for conversion to IF of the US/Europe (87.5 MHz to 108 MHz) and Japanese (76 MHz to 91 MHz) FM band
- Preset tuning to receive Japanese TV audio up to 108 MHz
- RF Automatic Gain Control (AGC) circuit
- LC tuner oscillator operating with low cost fixed chip inductors
- FM IF selectivity performed internally
- No external discriminator needed due to fully integrated FM demodulator
- Crystal reference frequency oscillator; the oscillator operates with a 32.768 kHz clock crystal or with a 13 MHz crystal and with an externally applied 6.5 MHz reference frequency
- PLL synthesizer tuning system
- I<sup>2</sup>C-bus
- 7-bit IF counter output via the I<sup>2</sup>C-bus
- 4-bit level information output via the I<sup>2</sup>C-bus
- Soft mute
- Signal dependent mono to stereo blend [Stereo Noise Cancelling (SNC)]
- Signal dependent High Cut Control (HCC)



- Soft mute, SNC and HCC can be switched off via the I<sup>2</sup>C-bus
- Adjustment-free stereo decoder
- Autonomous search tuning function
- Standby mode
- Two software programmable ports
- Bus enable line to switch the bus input and output lines into 3-state mode.

## 2 GENERAL DESCRIPTION

The TEA5768HL is a single-chip electronically tuned FM stereo radio for low-voltage applications with fully integrated IF selectivity and demodulation. The radio is completely adjustment-free and only requires a minimum of small and low cost external components. The radio can be tuned to the European, US and Japanese FM bands.

## 3 ORDERING INFORMATION

TYPE NUMBER	PACKAGE		
	NAME	DESCRIPTION	VERSION
TEA5768HL	LQFP32	plastic low profile quad flat package; 32 leads; body 7 × 7 × 1.4 mm	SOT358-1

# Low-power FM stereo radio for handheld applications

TEA5768HL

## 4 QUICK REFERENCE DATA

$$V_{CCA} = V_{CC(VCO)} = V_{CCD}$$

SYMBOL	PARAMETER	CONDITIONS	MIN.	TYP.	MAX.	UNIT
$V_{CCA}$	analog supply voltage		2.5	3.0	5.0	V
$V_{CC(VCO)}$	voltage controlled oscillator supply voltage		2.5	3.0	5.0	V
$V_{CCD}$	digital supply voltage		2.5	3.0	5.0	V
$I_{CCA}$	analog supply current	operating; $V_{CCA} = 3$ V	6.0	8.4	10.5	mA
		standby mode; $V_{CCA} = 3$ V	–	3	6	$\mu$ A
$I_{CC(VCO)}$	voltage controlled oscillator supply current	operating; $V_{VCOTANK1} = V_{VCOTANK2} = 3$ V	560	750	940	$\mu$ A
		standby mode; $V_{VCOTANK1} = V_{VCOTANK2} = 3$ V	–	1	2	$\mu$ A
$I_{CCD}$	digital supply current	operating; $V_{CCD} = 3$ V	2.1	3.0	3.9	mA
		standby mode; $V_{CCD} = 3$ V				
		bus enable line HIGH	30	56	80	$\mu$ A
	bus enable line LOW	11	19	26	$\mu$ A	
$f_{FM(ant)}$	FM input frequency		76	–	108	MHz
$T_{amb}$	ambient temperature	$V_{CCA} = V_{CC(VCO)} = V_{CCD} = 2.5$ V to 5 V	–10	–	+75	$^{\circ}$ C
<b>FM overall system parameters; see Fig.5</b>						
$V_{RF}$	RF sensitivity input voltage	$f_{RF} = 76$ MHz to 108 MHz; $\Delta f = 22.5$ kHz; $f_{mod} = 1$ kHz; (S+N)/N = 26 dB; de-emphasis = 75 $\mu$ s; L = R; $B_{AF} = 300$ Hz to 15 kHz	–	2	3.5	$\mu$ V
$S_{-200}$	LOW side 200 kHz selectivity	$\Delta f = -200$ kHz; $f_{RF} = 76$ MHz to 108 MHz; note 1	32	36	–	dB
$S_{+200}$	HIGH side 200 kHz selectivity	$\Delta f = +200$ kHz; $f_{RF} = 76$ MHz to 108 MHz; note 1	39	43	–	dB
$V_{AFL}; V_{AFR}$	left and right audio frequency output voltage	$V_{RF} = 1$ mV; L = R; $\Delta f = 22.5$ kHz; $f_{mod} = 1$ kHz; de-emphasis = 75 $\mu$ s	60	75	90	mV
(S+N)/N	maximum signal plus noise-to-noise ratio	$V_{RF} = 1$ mV; L = R; $\Delta f = 22.5$ kHz; $f_{mod} = 1$ kHz; de-emphasis = 75 $\mu$ s; $B_{AF} = 300$ Hz to 15 kHz	54	60	–	dB
$\alpha_{cs(stereo)}$	stereo channel separation	$V_{RF} = 1$ mV; R = L = 0 or R = 0 and L = 1 including 9 % pilot; $\Delta f = 75$ kHz; $f_{mod} = 1$ kHz; data byte 3 bit 3 = 0; data byte 4 bit 1 = 1	24	30	–	dB
THD	total harmonic distortion	$V_{RF} = 1$ mV; L = R; $\Delta f = 75$ kHz; $f_{mod} = 1$ kHz; de-emphasis = 75 $\mu$ s	–	0.4	1	%

### Note

1. LOW side and HIGH side selectivity can be switched by changing the mixer from HIGH side to LOW side LO injection.

# Low-power FM stereo radio for handheld applications

## TEA5768HL

### 5 BLOCK DIAGRAM

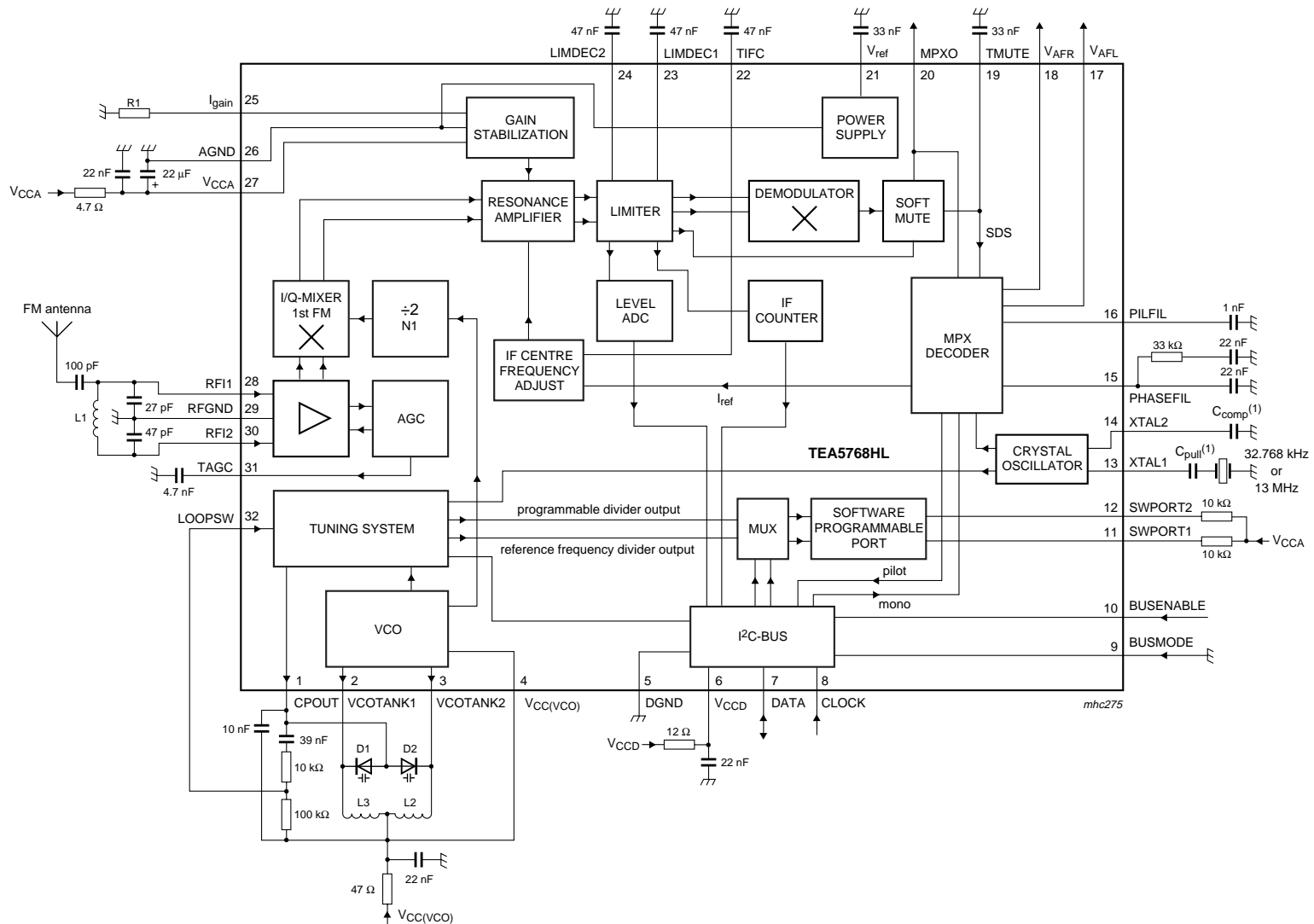

The component list is given Chapter 14.  
 (1)  $C_{comp}$  and  $C_{pull}$  data depends on crystal specification.

Fig.1 Block diagram.

# Low-power FM stereo radio for handheld applications

TEA5768HL

## 6 PINNING

SYMBOL	PIN	DESCRIPTION
CPOUT	1	charge pump output of synthesizer PLL
VCOTANK1	2	voltage controlled oscillator tuned circuit output 1
VCOTANK2	3	voltage controlled oscillator tuned circuit output 2
$V_{CC(VCO)}$	4	voltage controlled oscillator supply voltage
DGND	5	digital ground
$V_{CCD}$	6	digital supply voltage
DATA	7	bus data line input/output
CLOCK	8	bus clock line input
BUSMODE	9	bus mode select input
BUSENABLE	10	bus enable input
SWPORT1	11	software programmable port 1
SWPORT2	12	software programmable port 2
XTAL1	13	crystal oscillator input 1
XTAL2	14	crystal oscillator input 2
PHASEFIL	15	phase detector loop filter
PILFIL	16	pilot detector low-pass filter
$V_{AFL}$	17	left audio frequency output voltage
$V_{AFR}$	18	right audio frequency output voltage
TMUTE	19	time constant for soft mute
MPXO	20	FM demodulator MPX signal output
$V_{ref}$	21	reference voltage
TIFC	22	time constant for IF centre adjust
LIMDEC1	23	decoupling IF limiter 1
LIMDEC2	24	decoupling IF limiter 2
$I_{gain}$	25	gain control current for IF filter
AGND	26	analog ground
$V_{CCA}$	27	analog supply voltage
RF1	28	RF input 1
RFGND	29	RF ground
RFI2	30	RF input 2
TAGC	31	time constant RF AGC
LOOPSW	32	switch output of synthesizer PLL loop filter

Low-power FM stereo radio for handheld applications

TEA5768HL

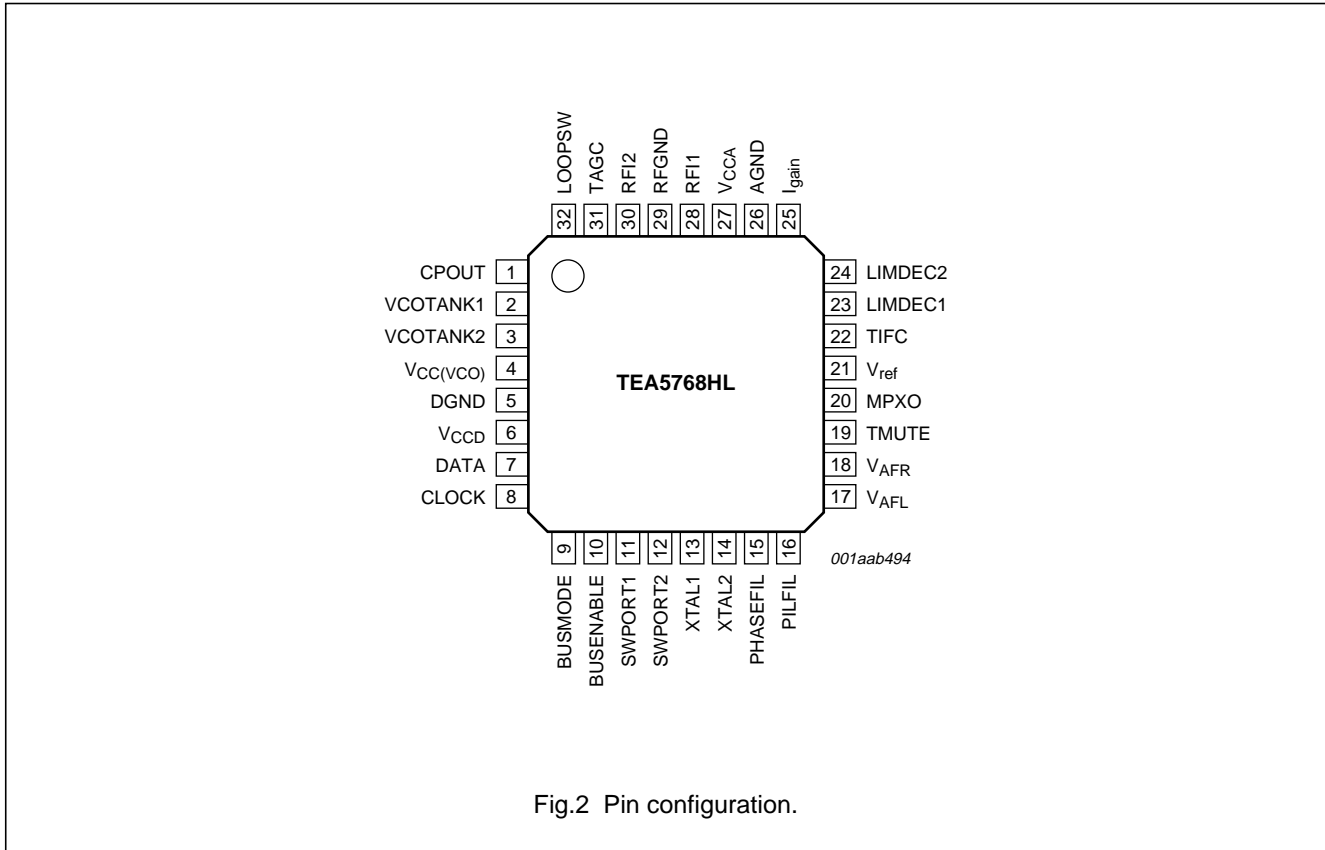

Fig.2 Pin configuration.

7 FUNCTIONAL DESCRIPTION

7.1 Low-noise RF amplifier

The LNA input impedance together with the LC RF input circuit defines an FM band filter. The gain of the LNA is controlled by the RF AGC circuit.

7.2 FM mixer

The FM quadrature mixer converts the FM RF (76 MHz to 108 MHz) to an IF of 225 kHz.

7.3 VCO

The varactor tuned LC VCO provides the Local Oscillator (LO) signal for the FM quadrature mixer. The VCO frequency range is 150 MHz to 217 MHz.

7.4 Crystal oscillator

The crystal oscillator can operate with a 32.768 kHz clock crystal or a 13 MHz crystal. The temperature drift of standard 32.768 kHz clock crystals limits the operational temperature range from -10 °C to +60 °C.

The PLL synthesizer can be clocked externally with a 32.768 kHz, a 6.5 MHz or a 13 MHz signal via pin XTAL2.

The crystal oscillator generates the reference frequency for:

- The reference frequency divider for the synthesizer PLL
- The timing for the IF counter
- The free-running frequency adjustment of the stereo decoder VCO
- The centre frequency adjustment of the IF filters.

7.5 PLL tuning system

The PLL synthesizer tuning system is suitable to operate with a 32.768 kHz or a 13 MHz reference frequency generated by the crystal oscillator or applied to the IC from an external source. The synthesizer can also be clocked via pin XTAL2 at 6.5 MHz. The PLL tuning system can perform an autonomous search tuning function.

7.6 RF AGC

The RF AGC prevents overloading and limits the amount of intermodulation products created by strong adjacent channels.

## Low-power FM stereo radio for handheld applications

TEA5768HL

### 7.7 IF filter

Fully integrated IF filter.

### 7.8 FM demodulator

The FM quadrature demodulator has an integrated resonator to perform the phase shift of the IF signal.

### 7.9 Level voltage generator and analog-to-digital converter

The FM IF analog level voltage is converted to 4 bits digital data and output via the I<sup>2</sup>C-bus.

### 7.10 IF counter

The IF counter outputs a 7-bit count result via the I<sup>2</sup>C-bus.

### 7.11 Soft mute

The low-pass filtered level voltage drives the soft mute attenuator at low RF input levels. The soft mute function can be switched off via the I<sup>2</sup>C-bus.

### 7.12 MPX decoder

The PLL stereo decoder is adjustment-free. The stereo decoder can be switched to mono via the I<sup>2</sup>C-bus.

### 7.13 Signal dependent mono to stereo blend

With a decreasing RF input level the MPX decoder blends from stereo to mono to limit the output noise. The continuous mono to stereo blend can also be programmed via the I<sup>2</sup>C-bus to an RF level depending switched mono to stereo transition. Stereo Noise Cancelling (SNC) can be switched off via the I<sup>2</sup>C-bus.

### 7.14 Signal dependent AF response

The audio bandwidth will be reduced with a decreasing RF input level. This function can be switched off via the I<sup>2</sup>C-bus.

### 7.15 Software programmable ports

Two software programmable ports (open-collector) can be addressed via the I<sup>2</sup>C-bus.

The port 1 (pin SWPORT1) function can be changed with write data byte 4 bit 0 (see Table 13). Pin SWPORT1 is then output for the ready flag of read byte 1.

## 8 I<sup>2</sup>C-BUS AND BUS-CONTROLLED FUNCTIONS

### 8.1 I<sup>2</sup>C-bus specification

Information about the I<sup>2</sup>C-bus can be found in the brochure "The I<sup>2</sup>C-bus and how to use it" (order number 9398 393 40011).

The standard I<sup>2</sup>C-bus specification is expanded by the following definitions.

IC address C0: 1100000.

Structure of the I<sup>2</sup>C-bus logic: slave transceiver.

Subaddresses are not used.

The maximum LOW-level input and the minimum HIGH-level input are specified to 0.2V<sub>CCD</sub> and 0.45V<sub>CCD</sub> respectively.

The pin BUSMODE must be connected to ground.

Before any READ or WRITE operation the pin BUSENABLE has to be HIGH for at least 10 μs.

**Note:** The bus operates at a maximum clock frequency of 400 kHz. It is not allowed to connect the IC to a bus operating at a higher clock rate.

#### 8.1.1 DATA TRANSFER

Data sequence: address, byte 1, byte 2, byte 3, byte 4 and byte 5 (the data transfer has to be in this order). The LSB = 0 of the address indicates a WRITE operation to the TEA5768HL.

Bit 7 of each byte is considered as the MSB and has to be transferred as the first bit of the byte.

The data becomes valid bitwise at the appropriate falling edge of the clock. A STOP condition after any byte can shorten transmission times.

When writing to the transceiver by using the STOP condition before completion of the whole transfer:

- The remaining bytes will contain the old information
- If the transfer of a byte is not completed, the new bits will be used, but a new tuning cycle will not be started.

The IC can be switched into a low current standby mode with the standby bit; the bus is then still active. The standby current can be reduced by deactivating the bus interface (pin BUSENABLE LOW). If the bus interface is deactivated (pin BUSENABLE LOW) without the standby mode being programmed, the IC maintains normal operation, but is isolated from the bus lines.



# Low-power FM stereo radio for handheld applications

## TEA5768HL

The software programmable output (SWPORT1) can be programmed to operate as a tuning indicator output. As long as the IC has not completed a tuning action, pin SWPORT1 remains LOW. The pin becomes HIGH, when a preset or search tuning is completed or when a band limit is reached.

The reference frequency divider of the synthesizer PLL is changed when the MSB in byte 5 is set to logic 1. The tuning system can then be clocked via pin XTAL2 at 6.5 MHz.

### 8.1.2 POWER-ON RESET

At Power-on reset the mute is set, all other bits are set to LOW. To initialize the IC all bytes have to be transferred.

## 8.2 I<sup>2</sup>C-bus protocol

**Table 1** Write mode

S <sup>(1)</sup>	address (write)	A <sup>(2)</sup>	data byte(s)	A <sup>(2)</sup>	P <sup>(3)</sup>
------------------	-----------------	------------------	--------------	------------------	------------------

**Notes**

1. S = START condition.
2. A = acknowledge.
3. P = STOP condition.

**Table 2** Read mode

S <sup>(1)</sup>	address (read)	A <sup>(2)</sup>	data byte 1
------------------	----------------	------------------	-------------

**Notes**

1. S = START condition.
2. A = acknowledge.

**Table 3** IC address byte

IC ADDRESS						MODE
1	1	0	0	0	0	R/W <sup>(1)</sup>

**Note**

1. Read or write mode:
  - a) 0 = write operation to the TEA5768HL
  - b) 1 = read operation from the TEA5768HL.

# Low-power FM stereo radio for handheld applications

TEA5768HL

## 8.3 Writing data

**Table 4** Write mode

DATA BYTE 1	DATA BYTE 2	DATA BYTE 3	DATA BYTE 4	DATA BYTE 5
-------------	-------------	-------------	-------------	-------------

**Table 5** Format of 1st data byte

BIT 7 (MSB)	BIT 6	BIT 5	BIT 4	BIT 3	BIT 2	BIT 1	BIT 0 (LSB)
MUTE	SM	PLL13	PLL12	PLL11	PLL10	PLL9	PLL8

**Table 6** Description of 1st data byte bits

BIT	SYMBOL	DESCRIPTION
7	MUTE	if MUTE = 1 then L and R audio are muted; if MUTE = 0 then L and R audio are not muted
6	SM	<b>Search Mode:</b> if SM = 1 then in search mode; if SM = 0 then not in search mode
5 to 0	PLL[13:8]	setting of synthesizer programmable counter for search or preset

**Table 7** Format of 2nd data byte

BIT 7 (MSB)	BIT 6	BIT 5	BIT 4	BIT 3	BIT 2	BIT 1	BIT 0 (LSB)
PLL7	PLL6	PLL5	PLL4	PLL3	PLL2	PLL1	PLL0

**Table 8** Description of 2nd data byte bits

BIT	SYMBOL	DESCRIPTION
7 to 0	PLL[7:0]	setting of synthesizer programmable counter for search or preset

**Table 9** Format of 3rd data byte

BIT 7 (MSB)	BIT 6	BIT 5	BIT 4	BIT 3	BIT 2	BIT 1	BIT 0 (LSB)
SUD	SSL1	SSL0	HLSI	MS	MR	ML	SWP1

**Table 10** Description of 3rd data byte bits

BIT	SYMBOL	DESCRIPTION
7	SUD	<b>Search Up/Down:</b> if SUD = 1 then search up; if SUD = 0 then search down
6 and 5	SSL[1:0]	<b>Search Stop Level:</b> see Table 11
4	HLSI	<b>HIGH/LOW Side Injection:</b> if HLSI = 1 then HIGH side LO injection; if HLSI = 0 then LOW side LO injection
3	MS	<b>Mono to Stereo:</b> if MS = 1 then forced mono; if MS = 0 then stereo ON
2	MR	<b>Mute Right:</b> if MR = 1 then the right audio channel is muted and forced mono; if MR = 0 then the right audio channel is not muted
1	ML	<b>Mute Left:</b> if ML = 1 then the left audio channel is muted and forced mono; if ML = 0 then the left audio channel is not muted
0	SWP1	<b>Software programmable port 1:</b> if SWP1 = 1 then port 1 is HIGH; if SWP1 = 0 then port 1 is LOW

# Low-power FM stereo radio for handheld applications

TEA5768HL

**Table 11** Search stop level setting

SSL1	SSL0	SEARCH STOP LEVEL
0	0	not allowed in search mode
0	1	low; level ADC output = 5
1	0	mid; level ADC output = 7
1	1	high; level ADC output = 10

**Table 12** Format of 4th data byte

BIT 7 (MSB)	BIT 6	BIT 5	BIT 4	BIT 3	BIT 2	BIT 1	BIT 0 (LSB)
SWP2	STBY	BL	XTAL	SMUTE	HCC	SNC	SI

**Table 13** Description of 4th data byte bits

BIT	SYMBOL	DESCRIPTION
7	SWP2	<b>Software programmable port 2:</b> if SWP2 = 1 then port 2 is HIGH; if SWP2 = 0 then port 2 is LOW
6	STBY	<b>Standby:</b> if STBY = 1 then in standby mode; if STBY = 0 then not in standby mode
5	BL	<b>Band Limits:</b> if BL = 1 then Japanese FM band; if BL = 0 then US/Europe FM band
4	XTAL	if XTAL = 1 then $f_{xtal} = 32.768$ kHz; if XTAL = 0 then $f_{xtal} = 13$ MHz
3	SMUTE	<b>Soft MUTE:</b> if SMUTE = 1 then soft mute is ON; if SMUTE = 0 then soft mute is OFF
2	HCC	<b>High Cut Control:</b> if HCC = 1 then high cut control is ON; if HCC = 0 then high cut control is OFF
1	SNC	<b>Stereo Noise Cancelling:</b> if SNC = 1 then stereo noise cancelling is ON; if SNC = 0 then stereo noise cancelling is OFF
0	SI	<b>Search Indicator:</b> if SI = 1 then pin SWPORT1 is output for the ready flag; if SI = 0 then pin SWPORT1 is software programmable port 1

**Table 14** Format of 5th data byte

BIT 7 (MSB)	BIT 6	BIT 5	BIT 4	BIT 3	BIT 2	BIT 1	BIT 0 (LSB)
PLLREF	DTC	–	–	–	–	–	–

**Table 15** Description of 5th data byte bits

BIT	SYMBOL	DESCRIPTION
7	PLLREF	if PLLREF = 1 then the 6.5 MHz reference frequency for the PLL is enabled; if PLLREF = 0 then the 6.5 MHz reference frequency for the PLL is disabled
6	DTC	if DTC = 1 then the de-emphasis time constant is 75 $\mu$ s; if DTC = 0 then the de-emphasis time constant is 50 $\mu$ s
5 to 0	–	not used; position is don't care

# Low-power FM stereo radio for handheld applications

TEA5768HL

## 8.4 Reading data

**Table 16** Read mode

DATA BYTE 1	DATA BYTE 2	DATA BYTE 3	DATA BYTE 4	DATA BYTE 5
-------------	-------------	-------------	-------------	-------------

**Table 17** Format of 1st data byte

BIT 7 (MSB)	BIT 6	BIT 5	BIT 4	BIT 3	BIT 2	BIT 1	BIT 0 (LSB)
RF	BLF	PLL13	PLL12	PLL11	PLL10	PLL9	PLL8

**Table 18** Description of 1st data byte bits

BIT	SYMBOL	DESCRIPTION
7	RF	<b>Ready Flag:</b> if RF = 1 then a station has been found or the band limit has been reached; if RF = 0 then no station has been found
6	BLF	<b>Band Limit Flag:</b> if BLF = 1 then the band limit has been reached; if BLF = 0 then the band limit has not been reached
5 to 0	PLL[13:8]	setting of synthesizer programmable counter after search or preset

**Table 19** Format of 2nd data byte

BIT 7 (MSB)	BIT 6	BIT 5	BIT 4	BIT 3	BIT 2	BIT 1	BIT 0 (LSB)
PLL7	PLL6	PLL5	PLL4	PLL3	PLL2	PLL1	PLL0

**Table 20** Description of 2nd data byte bits

BIT	SYMBOL	DESCRIPTION
7 to 0	PLL[7:0]	setting of synthesizer programmable counter after search or preset

**Table 21** Format of 3rd data byte

BIT 7 (MSB)	BIT 6	BIT 5	BIT 4	BIT 3	BIT 2	BIT 1	BIT 0 (LSB)
STEREO	IF6	IF5	IF4	IF3	IF2	IF1	IF0

**Table 22** Description of 3rd data byte bits

BIT	SYMBOL	DESCRIPTION
7	STEREO	<b>Stereo indication:</b> if STEREO = 1 then stereo reception; if STEREO = 0 then mono reception
6 to 0	PLL[13:8]	IF counter result

# Low-power FM stereo radio for handheld applications

TEA5768HL

**Table 23** Format of 4th data byte

BIT 7 (MSB)	BIT 6	BIT 5	BIT 4	BIT 3	BIT 2	BIT 1	BIT 0 (LSB)
LEV3	LEV2	LEV1	LEV0	CI3	CI2	CI1	0

**Table 24** Description of 4th data byte bits

BIT	SYMBOL	DESCRIPTION
7 to 4	LEV[3:0]	level ADC output
3 to 1	CI[3:1]	<b>Chip Identification:</b> these bits have to be set to logic 0
0	–	this bit is internally set to logic 0

**Table 25** Format of 5th data byte

BIT 7 (MSB)	BIT 6	BIT 5	BIT 4	BIT 3	BIT 2	BIT 1	BIT 0 (LSB)
0	0	0	0	0	0	0	0

**Table 26** Description of 5th data byte bits

BIT	SYMBOL	DESCRIPTION
7 to 0	–	reserved for future extensions; these bits are internally set to logic 0

## 8.5 Bus timing

**Table 27** Digital levels and timing

SYMBOL	PARAMETER	CONDITIONS	MIN.	MAX.	UNIT
<b>Digital inputs</b>					
$V_{IH}$	HIGH-level input voltage		$0.45V_{CCD}$	–	V
$V_{IL}$	LOW-level input voltage		–	$0.2V_{CCD}$	V
<b>Digital outputs</b>					
$I_{sink(L)}$	LOW-level sink current		500	–	$\mu A$
$V_{OL}$	LOW-level output voltage	$I_{OL} = 500 \mu A$	–	450	mV
<b>Timing (I<sup>2</sup>C-bus enabled)</b>					
$f_{clk}$	clock input frequency		–	400	kHz
$t_{HIGH}$	clock HIGH time		1	–	$\mu s$
$t_{LOW}$	clock LOW time		1	–	$\mu s$

# Low-power FM stereo radio for handheld applications

TEA5768HL

## 9 LIMITING VALUES

In accordance with the Absolute Maximum Rating System (IEC 60134).

SYMBOL	PARAMETER	CONDITIONS	MIN.	MAX.	UNIT
V <sub>VCOTANK1</sub>	VCO tuned circuit output voltage 1		-0.3	+8	V
V <sub>VCOTANK2</sub>	VCO tuned circuit output voltage 2		-0.3	+8	V
V <sub>CCD</sub>	digital supply voltage		-0.3	+5	V
V <sub>CCA</sub>	analog supply voltage		-0.3	+8	V
T <sub>stg</sub>	storage temperature		-55	+150	°C
T <sub>amb</sub>	ambient temperature		-10	+75	°C
V <sub>es</sub>	electrostatic handling voltage for all pins except pin DATA	note 1	-200	+200	V
		note 2	-2000	+2000	V
	for pin DATA	note 1	-150	+200	V
		note 2	-2000	+2000	V

### Notes

1. Machine model (R = 0 Ω, C = 200 pF).
2. Human body model (R = 1.5 kΩ, C = 100 pF).

## 10 THERMAL CHARACTERISTICS

SYMBOL	PARAMETER	CONDITIONS	VALUE	UNIT
R <sub>th(j-a)</sub>	thermal resistance from junction to ambient	in free air	80	K/W

# Low-power FM stereo radio for handheld applications

TEA5768HL

## 11 DC CHARACTERISTICS

$V_{CCA} = V_{VCOTANK1} = V_{VCOTANK2} = V_{CCD} = 2.7\text{ V}$ ;  $T_{amb} = 25\text{ °C}$ ; unless otherwise specified.

SYMBOL	PARAMETER	CONDITIONS	MIN.	TYP.	MAX.	UNIT
<b>Supply voltages; note 1</b>						
$V_{CCA}$	analog supply voltage		2.5	3.0	5.0	V
$V_{CC(VCO)}$	voltage controlled oscillator supply voltage		2.5	3.0	5.0	V
$V_{CCD}$	digital supply voltage		2.5	3.0	5.0	V
<b>Supply currents</b>						
$I_{CCA}$	analog supply current	operating				
		$V_{CCA} = 3\text{ V}$	6.0	8.4	10.5	mA
		$V_{CCA} = 5\text{ V}$	6.2	8.6	10.7	mA
		standby mode				
	$V_{CCA} = 3\text{ V}$	–	3	6	$\mu\text{A}$	
	$V_{CCA} = 5\text{ V}$	–	3.2	6.2	$\mu\text{A}$	
$I_{CC(VCO)}$	voltage controlled oscillator supply current	operating				
		$V_{VCOTANK1} = V_{VCOTANK2} = 3\text{ V}$	560	750	940	$\mu\text{A}$
		$V_{VCOTANK1} = V_{VCOTANK2} = 5\text{ V}$	570	760	950	$\mu\text{A}$
		standby mode				
	$V_{VCOTANK1} = V_{VCOTANK2} = 3\text{ V}$	–	1	2	$\mu\text{A}$	
	$V_{VCOTANK1} = V_{VCOTANK2} = 5\text{ V}$	–	1.2	2.2	$\mu\text{A}$	
$I_{CCD}$	digital supply current	operating				
		$V_{CCD} = 3\text{ V}$	2.1	3.0	3.9	mA
		$V_{CCD} = 5\text{ V}$	2.25	3.15	4.05	mA
		standby mode; $V_{CCD} = 3\text{ V}$				
		bus enable line HIGH	30	56	80	$\mu\text{A}$
		bus enable line LOW	11	19	26	$\mu\text{A}$
standby mode; $V_{CCD} = 5\text{ V}$	bus enable line HIGH	50	78	105	$\mu\text{A}$	
	bus enable line LOW	20	33	45	$\mu\text{A}$	

# Low-power FM stereo radio for handheld applications

TEA5768HL

SYMBOL	PARAMETER	CONDITIONS	MIN.	TYP.	MAX.	UNIT
<b>DC operating points</b>						
V <sub>CPOUT</sub>	unloaded DC voltage		0.1	–	V <sub>CC(VCO)</sub> – 0.1	V
V <sub>XTAL1</sub>		data byte 4 bit 4 = 1	1.64	1.72	1.8	V
		data byte 4 bit 4 = 0	1.68	1.75	1.82	V
V <sub>XTAL2</sub>		data byte 4 bit 4 = 1	1.64	1.72	1.8	V
		data byte 4 bit 4 = 0	1.68	1.75	1.82	V
V <sub>PHASEFIL</sub>			0.4	1.2	V <sub>CCA</sub> – 0.4	V
V <sub>PILFIL</sub>			0.65	0.9	1.3	V
V <sub>VAFIL</sub>		f <sub>RF</sub> = 98 MHz; V <sub>RF</sub> = 1 mV	720	850	940	mV
V <sub>VAFR</sub>		f <sub>RF</sub> = 98 MHz; V <sub>RF</sub> = 1 mV	720	850	940	mV
V <sub>TMUTE</sub>		V <sub>RF</sub> = 0 V	1.5	1.65	1.8	V
V <sub>MPXO</sub>		f <sub>RF</sub> = 98 MHz; V <sub>RF</sub> = 1 mV	680	815	950	mV
V <sub>Vref</sub>			1.45	1.55	1.65	V
V <sub>TIFC</sub>			1.34	1.44	1.54	V
V <sub>LIMDEC1</sub>			1.86	1.98	2.1	V
V <sub>LIMDEC2</sub>			1.86	1.98	2.1	V
V <sub>Igain</sub>			480	530	580	mV
V <sub>RFI1</sub>			0.93	1.03	1.13	V
V <sub>RFI2</sub>			0.93	1.03	1.13	V
V <sub>TAGC</sub>		V <sub>RF</sub> = 0 V	1	1.57	2	V

**Note**

1. V<sub>CCA</sub>, V<sub>CC(VCO)</sub> and V<sub>CCD</sub> must not differ more than 200 mV.



# Low-power FM stereo radio for handheld applications

TEA5768HL

## 12 AC CHARACTERISTICS

$V_{CCA} = V_{VCOTANK1} = V_{VCOTANK2} = V_{CCD} = 2.7\text{ V}$ ;  $T_{amb} = 25\text{ °C}$ ; measured in the circuit of Fig.5; all AC values are given in RMS; unless otherwise specified.

SYMBOL	PARAMETER	CONDITIONS	MIN.	TYP.	MAX.	UNIT
<b>Voltage controlled oscillator</b>						
$f_{osc}$	oscillator frequency		150	–	217	MHz
<b>Crystal oscillator</b>						
CIRCUIT INPUT: PIN XTAL2						
$V_{i(osc)}$	oscillator input voltage	oscillator externally clocked	140	–	350	mV
$R_i$	input resistance	oscillator externally clocked				
		data byte 4 bit 4 = 0	2	3	4	k $\Omega$
		data byte 4 bit 4 = 1	230	330	430	k $\Omega$
$C_i$	input capacitance	oscillator externally clocked				
		data byte 4 bit 4 = 0	3.9	5.6	7.3	pF
		data byte 4 bit 4 = 1	5	6	7	pF
CRYSTAL: 32.768 kHz						
$f_r$	series resonance frequency	data byte 4 bit 4 = 1	–	32.768	–	kHz
$\Delta f/f_r$	frequency deviation		$-20 \times 10^{-6}$	–	$+20 \times 10^{-6}$	
$C_0$	shunt capacitance		–	–	3.5	pF
$R_S$	series resistance		–	–	80	k $\Omega$
$\Delta f_r/f_r(25\text{ °C})$	temperature drift	$-10\text{ °C} < T_{amb} < +60\text{ °C}$	$-50 \times 10^{-6}$	–	$+50 \times 10^{-6}$	
CRYSTAL: 13 MHz						
$f_r$	series resonance frequency	data byte 4 bit 4 = 0	–	13	–	MHz
$\Delta f/f_r$	frequency deviation		$-30 \times 10^{-6}$	–	$+30 \times 10^{-6}$	
$C_0$	shunt capacitance		–	–	4.5	pF
$C_{mot}$	motional capacitance		1.5	–	3.0	fF
$R_S$	series resistance		–	–	100	$\Omega$
$\Delta f_r/f_r(25\text{ °C})$	temperature drift	$-40\text{ °C} < T_{amb} < +85\text{ °C}$	$-30 \times 10^{-6}$	–	$+30 \times 10^{-6}$	
<b>Synthesizer</b>						
PROGRAMMABLE DIVIDER; note 1						
$N_{prog}$	programmable divider ratio	data byte 1 = XX111111; data byte 2 = 11111110	–	–	8191	
		data byte 1 = XX010000; data byte 2 = 00000000	2048	–	–	
$\Delta N_{step}$	programmable divider step size		–	1	–	
REFERENCE FREQUENCY DIVIDER						
$N_{ref}$	crystal oscillator divider ratio	data byte 4 bit 4 = 0	–	260	–	
		data byte 5 bit 7 = 1; data byte 4 bit 4 = 0	–	130	–	
		data byte 4 bit 4 = 1	–	1	–	

# Low-power FM stereo radio for handheld applications

TEA5768HL

SYMBOL	PARAMETER	CONDITIONS	MIN.	TYP.	MAX.	UNIT
<b>CHARGE PUMP: PIN CPOUT</b>						
$I_{\text{sink}}$	charge pump peak sink current	$0.2 \text{ V} < V_{\text{CPOUT}} < V_{\text{VCOTANK2}} - 0.2 \text{ V};$ $f_{\text{VCO}} > f_{\text{ref}} \times N_{\text{prog}}$	–	0.5	–	$\mu\text{A}$
$I_{\text{source}}$	charge pump peak source current	$0.2 \text{ V} < V_{\text{CPOUT}} < V_{\text{VCOTANK2}} - 0.2 \text{ V};$ $f_{\text{VCO}} < f_{\text{ref}} \times N_{\text{prog}}$	–	–0.5	–	$\mu\text{A}$
<b>IF counter</b>						
$V_{\text{RF}}$	RF input voltage for correct IF count		–	12	18	$\mu\text{V}$
$N_{\text{IF}}$	IF counter length		–	7	–	bit
$N_{\text{precount}}$	IF counter prescaler ratio		–	64	–	
$T_{\text{count(IF)}}$	IF counter period	$f_{\text{xtal}} = 32.768 \text{ kHz}$	–	15.625	–	ms
		$f_{\text{xtal}} = 13 \text{ MHz}$	–	15.754	–	ms
$\text{RES}_{\text{count(IF)}}$	IF counter resolution	$f_{\text{xtal}} = 32.768 \text{ kHz}$	–	4.096	–	kHz
		$f_{\text{xtal}} = 13 \text{ MHz}$	–	4.0625	–	kHz
$\text{IF}_{\text{count}}$	IF counter result for search tuning stop	$f_{\text{xtal}} = 32.768 \text{ kHz}$	31	–	3E	HEX
		$f_{\text{xtal}} = 13 \text{ MHz}$	32	–	3D	HEX
<b>Pins DATA, CLOCK, BUSMODE and BUSENABLE</b>						
$R_i$	input resistance		10	–	–	$\text{M}\Omega$
<b>Software programmable ports</b>						
<b>PIN SWPORT1</b>						
$I_{\text{sink(max)}}$	maximum sink current	data byte 3 bit 0 = 0; data byte 4 bit 0 = 0; $V_{\text{SWPORT1}} < 0.5 \text{ V}$	500	–	–	$\mu\text{A}$
$I_{\text{leak(max)}}$	maximum leakage current	data byte 3 bit 0 = 1; $V_{\text{SWPORT1}} < 5 \text{ V}$	–1	–	+1	$\mu\text{A}$
<b>PIN SWPORT2</b>						
$I_{\text{sink(max)}}$	maximum sink current	data byte 4 bit 7 = 0; $V_{\text{SWPORT1}} < 0.5 \text{ V}$	500	–	–	$\mu\text{A}$
$I_{\text{leak(max)}}$	maximum leakage current	data byte 4 bit 7 = 1; $V_{\text{SWPORT1}} < 5 \text{ V}$	–1	–	+1	$\mu\text{A}$
<b>FM signal channel</b>						
<b>FM RF INPUT</b>						
$R_i$	input resistance at pins RFI1 and RFI2 to RFGND		75	100	125	$\Omega$
$C_i$	input capacitance at pins RFI1 and RFI2 to RFGND		2.5	4	6	pF

# Low-power FM stereo radio for handheld applications

TEA5768HL

SYMBOL	PARAMETER	CONDITIONS	MIN.	TYP.	MAX.	UNIT
$V_{RF}$	RF sensitivity input voltage	$f_{RF} = 76 \text{ MHz to } 108 \text{ MHz};$ $\Delta f = 22.5 \text{ kHz}; f_{\text{mod}} = 1 \text{ kHz};$ $(S+N)/N = 26 \text{ dB};$ de-emphasis = 75 $\mu\text{s};$ $B_{AF} = 300 \text{ Hz to } 15 \text{ kHz}$	–	2	3.5	$\mu\text{V}$
$IP3_{\text{in}}$	in-band 3rd-order intercept point related to $V_{RF1-1}, V_{RF1-2}$ (peak value)	$\Delta f_1 = 200 \text{ kHz}; \Delta f_2 = 400 \text{ kHz};$ $f_{\text{tune}} = 76 \text{ MHz to } 108 \text{ MHz}$	81	84	–	$\text{dB}\mu\text{V}$
$IP3_{\text{out}}$	out-band 3rd-order intercept point related to $V_{RF1-1}, V_{RF1-2}$ (peak value)	$\Delta f_1 = 4 \text{ MHz}; \Delta f_2 = 8 \text{ Hz};$ $f_{\text{tune}} = 76 \text{ MHz to } 108 \text{ MHz}$	82	85	–	$\text{dB}\mu\text{V}$
<b>RF AGC</b>						
$V_{RF1}$	RF input voltage for start of AGC	$f_{RF1} = 93 \text{ MHz}; f_{RF2} = 98 \text{ MHz};$ $V_{RF2} = 50 \text{ dB}\mu\text{V};$ $\left  \frac{\Delta V_{\text{TMUTE}}}{V_{RF1}} \right  < \frac{14 \text{ mV}}{3 \text{ dB}\mu\text{V}}; \text{ note 2}$	66	72	78	$\text{dB}\mu\text{V}$
<b>IF filter</b>						
$f_{IF}$	IF filter centre frequency		215	225	235	$\text{kHz}$
$B_{IF}$	IF filter bandwidth		85	94	102	$\text{kHz}$
$S_{+200}$	HIGH side 200 kHz selectivity	$\Delta f = +200 \text{ kHz};$ $f_{\text{tune}} = 76 \text{ MHz to } 108 \text{ MHz};$ note 3	39	43	–	$\text{dB}$
$S_{-200}$	LOW side 200 kHz selectivity	$\Delta f = -200 \text{ kHz};$ $f_{\text{tune}} = 76 \text{ MHz to } 108 \text{ MHz};$ note 3	32	36	–	$\text{dB}$
$S_{+100}$	HIGH side 100 kHz selectivity	$\Delta f = +100 \text{ kHz};$ $f_{\text{tune}} = 76 \text{ MHz to } 108 \text{ MHz};$ note 3	8	12	–	$\text{dB}$
$S_{-100}$	LOW side 100 kHz selectivity	$\Delta f = -100 \text{ kHz};$ $f_{\text{tune}} = 76 \text{ MHz to } 108 \text{ MHz};$ note 3	8	12	–	$\text{dB}$
IR	image rejection	$f_{\text{tune}} = 76 \text{ MHz to } 108 \text{ MHz};$ $V_{RF} = 50 \text{ dB}\mu\text{V}$	24	30	–	$\text{dB}$
<b>FM IF level detector and mute voltage</b>						
$V_{RF}$	RF input voltage for start of level ADC	read mode data byte 4 bit 4 = 1	2	3	5	$\mu\text{V}$
$\Delta V_{\text{step}}$	level ADC step size		2	3	5	$\text{dB}$
<b>PIN TMUTE</b>						
$V_{\text{level}}$	level output DC voltage	$V_{RF} = 0 \mu\text{V}$	1.55	1.65	1.80	$\text{V}$
		$V_{RF} = 3 \mu\text{V}$	1.60	1.70	1.85	$\text{V}$
$V_{\text{level(slope)}}$	slope of level voltage	$V_{RF} = 10 \mu\text{V to } 500 \mu\text{V}$	150	165	180	$\frac{\text{mV}}{20 \text{ dB}}$
$R_o$	output resistance		280	400	520	$\text{k}\Omega$

# Low-power FM stereo radio for handheld applications

TEA5768HL

SYMBOL	PARAMETER	CONDITIONS	MIN.	TYP.	MAX.	UNIT
<b>FM demodulator: pin MPXO</b>						
$V_{MPXO}$	demodulator output voltage	$V_{RF} = 1 \text{ mV}$ ; $L = R$ ; $\Delta f = 22.5 \text{ kHz}$ ; $f_{mod} = 1 \text{ kHz}$ ; de-emphasis = $75 \mu\text{s}$ ; $B_{AF} = 300 \text{ Hz to } 15 \text{ kHz}$	60	75	90	mV
(S+N)/N	maximum signal plus noise-to-noise ratio	$V_{RF} = 1 \text{ mV}$ ; $L = R$ ; $\Delta f = 22.5 \text{ kHz}$ ; $f_{mod} = 1 \text{ kHz}$ ; de-emphasis = $75 \mu\text{s}$ ; $B_{AF} = 300 \text{ Hz to } 15 \text{ kHz}$	54	60	–	dB
THD	total harmonic distortion	$V_{RF} = 1 \text{ mV}$ ; $L = R$ ; $\Delta f = 75 \text{ kHz}$ ; $f_{mod} = 1 \text{ kHz}$ ; de-emphasis = $75 \mu\text{s}$	–	0.5	1.5	%
$\alpha_{AM}$	AM suppression	$V_{RF} = 300 \mu\text{V}$ ; $L = R$ ; $\Delta f = 22.5 \text{ kHz}$ ; $f_{mod} = 1 \text{ kHz}$ ; $m = 0.3$ ; de-emphasis = $75 \mu\text{s}$ ; $B_{AF} = 300 \text{ Hz to } 15 \text{ kHz}$	40	–	–	dB
$R_o$	demodulator output resistance		–	–	500	$\Omega$
$I_{sink}$	demodulator output sink current		–	–	30	$\mu\text{A}$
<b>Soft mute</b>						
$V_{RF}$	RF input voltage for soft mute start	$\alpha_{mute} = 3 \text{ dB}$ ; data byte 4 bit 3 = 1	3	5	10	$\mu\text{V}$
$\alpha_{mute}$	mute attenuation	$V_{RF} = 1 \mu\text{V}$ ; $L = R$ ; $\Delta f = 22.5 \text{ kHz}$ ; $f_{mod} = 1 \text{ kHz}$ ; de-emphasis = $75 \mu\text{s}$ ; $B_{AF} = 300 \text{ Hz to } 15 \text{ kHz}$ ; data byte 4 bit 3 = 1	10	20	30	dB
<b>MPX decoder</b>						
$V_{AFL}$ ; $V_{AFR}$	left and right audio frequency output voltage	$V_{RF} = 1 \text{ mV}$ ; $L = R$ ; $\Delta f = 22.5 \text{ kHz}$ ; $f_{mod} = 1 \text{ kHz}$ ; de-emphasis = $75 \mu\text{s}$	60	75	90	mV
$R_{AFL}$ ; $R_{AFR}$	left and right audio frequency output resistance		–	–	50	$\Omega$
$I_{sink(AFL)}$ ; $I_{sink(AFR)}$	left and right audio frequency output sink current		170	–	–	$\mu\text{A}$
$V_{MPXIN(max)}$	input overdrive margin	THD < 3 %	4	–	–	dB
$V_{AFL}/V_{AFR}$	left and right audio frequency output voltage difference	$V_{RF} = 1 \text{ mV}$ ; $L = R$ ; $\Delta f = 75 \text{ kHz}$ ; $f_{mod} = 1 \text{ kHz}$ ; de-emphasis = $75 \mu\text{s}$	–1	–	+1	dB
$\alpha_{cs(stereo)}$	stereo channel separation	$V_{RF} = 1 \text{ mV}$ ; $R = L = 0$ or $R = 0$ and $L = 1$ including 9 % pilot; $\Delta f = 75 \text{ kHz}$ ; $f_{mod} = 1 \text{ kHz}$ ; data byte 3 bit 3 = 0; data byte 4 bit 1 = 1	24	30	–	dB

# Low-power FM stereo radio for handheld applications

TEA5768HL

SYMBOL	PARAMETER	CONDITIONS	MIN.	TYP.	MAX.	UNIT
(S+N)/N	maximum signal plus noise-to-noise ratio	$V_{RF} = 1 \text{ mV}$ ; $L = R$ ; $\Delta f = 22.5 \text{ kHz}$ ; $f_{mod} = 1 \text{ kHz}$ ; de-emphasis = $75 \mu\text{s}$ ; $B_{AF} = 300 \text{ Hz to } 15 \text{ kHz}$	54	60	–	dB
THD	total harmonic distortion	$V_{RF} = 1 \text{ mV}$ ; $L = R$ ; $\Delta f = 75 \text{ kHz}$ ; $f_{mod} = 1 \text{ kHz}$ ; de-emphasis = $75 \mu\text{s}$	–	0.4	1	%
$\alpha_{pilot}$	pilot suppression measured at pins $V_{AFL}$ and $V_{AFR}$	related to $\Delta f = 75 \text{ kHz}$ ; $f_{mod} = 1 \text{ kHz}$ ; de-emphasis = $75 \mu\text{s}$	40	50	–	dB
$\Delta f_{pilot}$	stereo pilot frequency deviation	$V_{RF} = 1 \text{ mV}$ ; read mode; data byte 3 bit 7 = 1 bit 7 = 0	– 1	3.6 3	5.8 –	kHz kHz
$\frac{\Delta f_{pilot1}}{\Delta f_{pilot2}}$	pilot switch hysteresis	$V_{RF} = 1 \text{ mV}$	2	–	–	dB
HIGH CUT CONTROL						
$TC_{de-em}$	de-emphasis time constant	$V_{RF} = 1 \text{ mV}$ data byte 5 bit 6 = 0	38	50	62	$\mu\text{s}$
		data byte 5 bit 6 = 1	57	75	93	$\mu\text{s}$
		$V_{RF} = 1 \mu\text{V}$ data byte 5 bit 6 = 0	114	150	186	$\mu\text{s}$
		data byte 5 bit 6 = 1	171	225	279	$\mu\text{s}$
MONO TO STEREO BLEND CONTROL						
$\alpha_{cs(stereo)}$	stereo channel separation	$V_{RF} = 45 \mu\text{V}$ ; $R = L = 0$ or $R = 0$ and $L = 1$ including 9 % pilot; $\Delta f = 75 \text{ kHz}$ ; $f_{mod} = 1 \text{ kHz}$ ; data byte 3 bit 3 = 0; data byte 4 bit 1 = 1	4	10	16	dB
MONO TO STEREO SWITCHED						
$\alpha_{cs(stereo)}$	stereo channel separation switching from mono to stereo with increasing RF input level	$V_{RF} = 1 \text{ mV}$ ; $R = L = 0$ or $R = 0$ and $L = 1$ including 9 % pilot; $\Delta f = 75 \text{ kHz}$ ; $f_{mod} = 1 \text{ kHz}$ ; data byte 3 bit 3 = 0; data byte 4 bit 1 = 0	24	–	–	dB
$\alpha_{cs(stereo)}$	stereo channel separation switching from stereo to mono with decreasing RF input level	$V_{RF} = 20 \mu\text{V}$ ; $R = L = 0$ or $R = 0$ and $L = 1$ including 9 % pilot; $\Delta f = 75 \text{ kHz}$ ; $f_{mod} = 1 \text{ kHz}$ ; data byte 3 bit 3 = 0; data byte 4 bit 1 = 0	–	–	1	dB

# Low-power FM stereo radio for handheld applications

TEA5768HL

SYMBOL	PARAMETER	CONDITIONS	MIN.	TYP.	MAX.	UNIT
BUS-DRIVEN MUTE FUNCTIONS						
<i>Tuning mute</i>						
$\alpha_{\text{mute}}$	$V_{\text{AFL}}$ and $V_{\text{AFR}}$ muting depth	data byte 1 bit 7 = 1	–	–	–60	dB
$\alpha_{\text{mute(L)}}$	$V_{\text{AFL}}$ muting depth	data byte 3 bit 1 = 1; $f_{\text{AF}} = 1 \text{ kHz}$ ; $R_{\text{load(L)}} < 30 \text{ k}\Omega$	–	–	–80	dB
$\alpha_{\text{mute(R)}}$	$V_{\text{AFR}}$ muting depth	data byte 3 bit 2 = 1; $f_{\text{AF}} = 1 \text{ kHz}$ ; $R_{\text{load(R)}} < 30 \text{ k}\Omega$	–	–	–80	dB

## Notes

1. Calculation of this 14-bit word can be done as follows:

$$\text{formula for HIGH side injection: } N = \frac{4 \times (f_{\text{RF}} + f_{\text{IF}})}{f_{\text{ref}}}; \text{ formula for LOW side injection: } N = \frac{4 \times (f_{\text{RF}} - f_{\text{IF}})}{f_{\text{ref}}}$$

where:

$N$  = decimal value of PLL word

$f_{\text{RF}}$  = the wanted tuning frequency [Hz]

$f_{\text{IF}}$  = the intermediate frequency [Hz] = 225 kHz

$f_{\text{ref}}$  = the reference frequency [Hz] = 32.768 kHz for the 32.768 kHz crystal;  $f_{\text{ref}} = 50 \text{ kHz}$  for the 13 MHz crystal or when externally clocked with 6.5 MHz.

$$\text{Example for receiving a channel at 100 MHz with HIGH side injection: } N = \frac{4 \times (100 \times 10^6 + 225 \times 10^3)}{32768} = 12234.$$

The PLL word becomes 2FCAH.

2.  $V_{\text{RF}}$  in Fig.5 is replaced by  $V_{\text{RF1}} + V_{\text{RF2}}$ . The radio is tuned to 98 MHz (HIGH side injection).
3. LOW side and HIGH side selectivity can be switched by changing the mixer from HIGH side to LOW side LO injection.

Low-power FM stereo radio for handheld applications

TEA5768HL

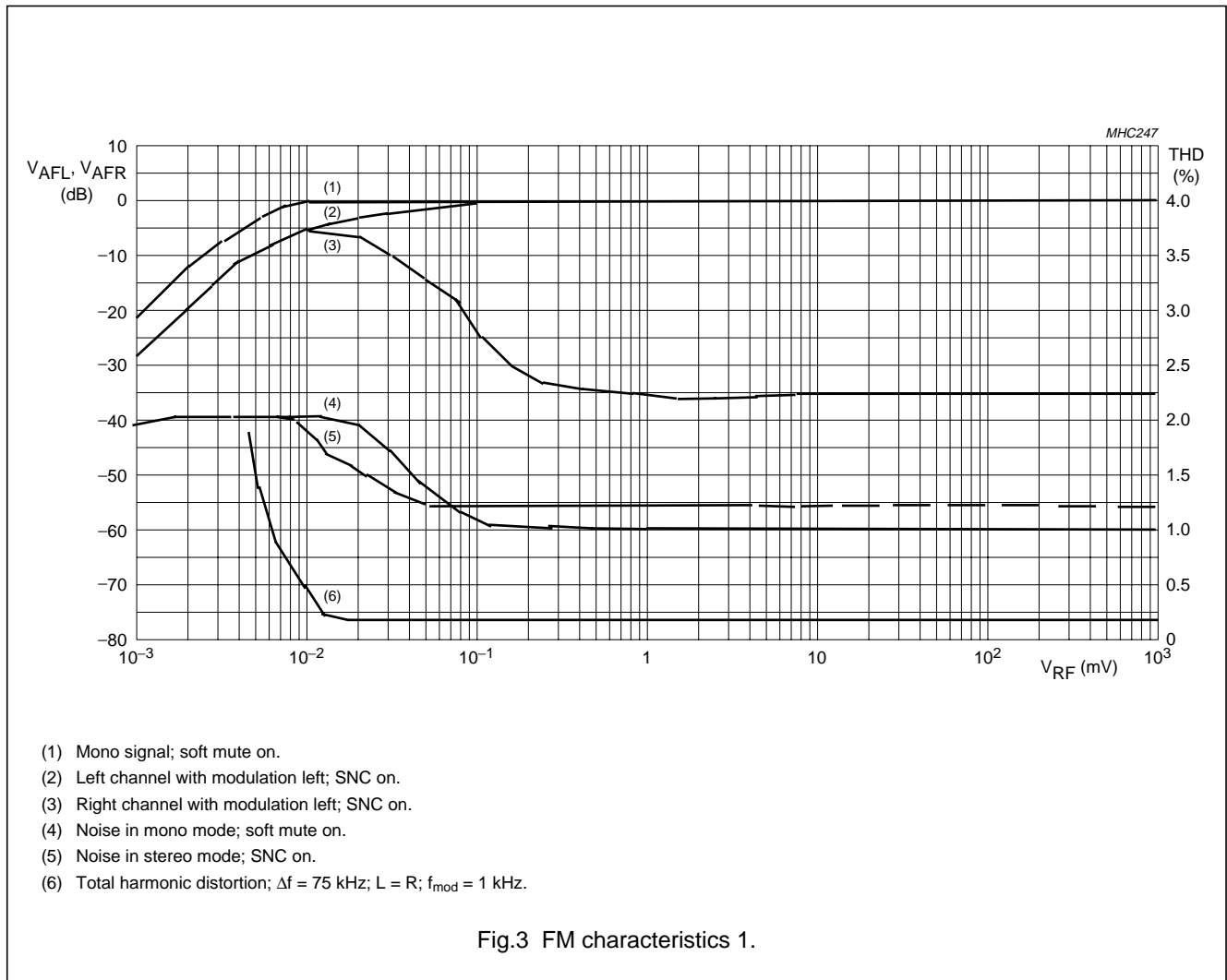

Low-power FM stereo radio for handheld applications

TEA5768HL

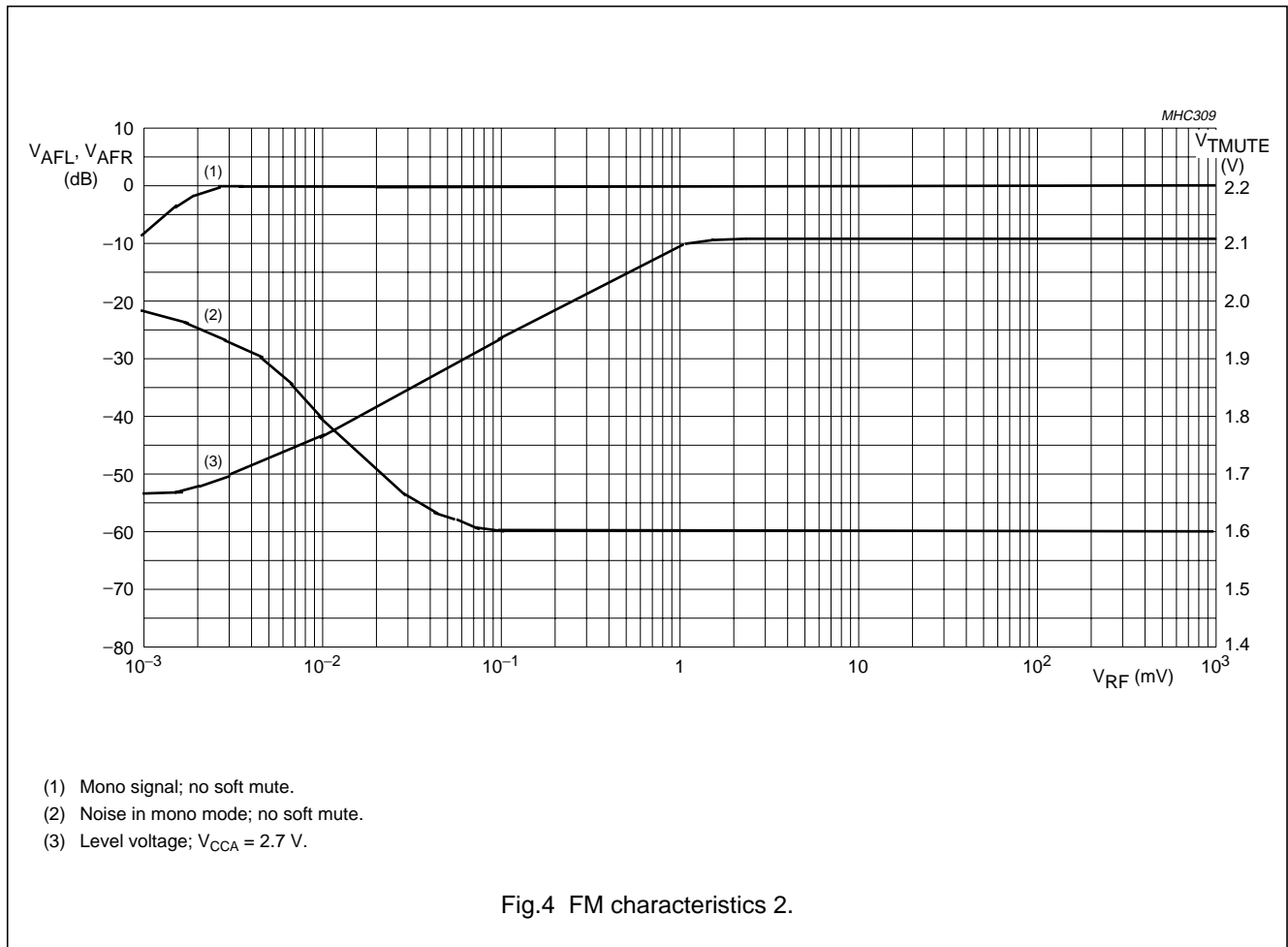



Low-power FM stereo radio for handheld applications

TEA5768HL

13 INTERNAL PIN CONFIGURATION

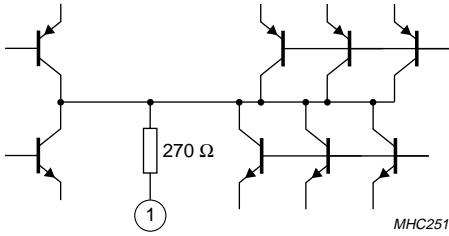
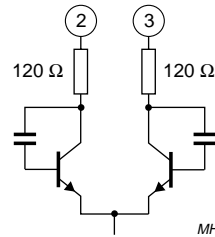
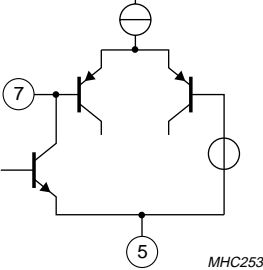
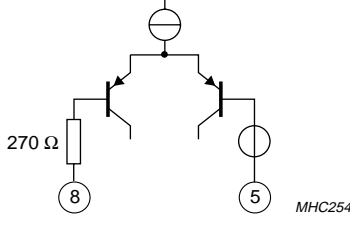
PIN	SYMBOL	EQUIVALENT CIRCUIT
1	CPOUT	
2	VCOTANK1	
3	VCOTANK2	
4	V <sub>CC(VCO)</sub>	
5	DGND	
6	V <sub>CCD</sub>	
7	DATA	
8	CLOCK	

Low-power FM stereo radio for handheld applications

TEA5768HL

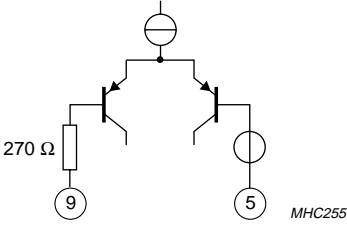
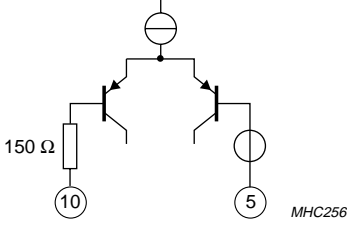
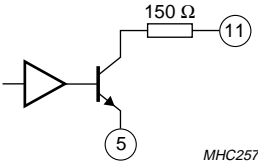
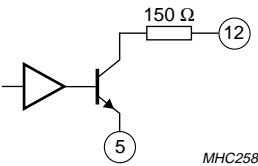
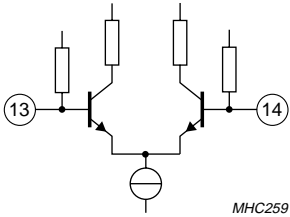
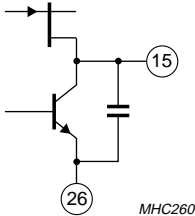
PIN	SYMBOL	EQUIVALENT CIRCUIT
9	BUSMODE	
10	BUSEnable	
11	SWPORT1	
12	SWPORT2	
13	XTAL1	
14	XTAL2	
15	PHASEFIL	

Low-power FM stereo radio for handheld applications

TEA5768HL

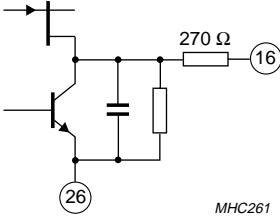
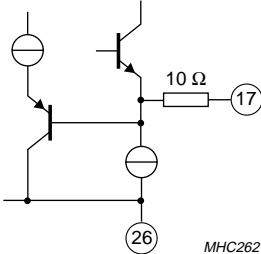
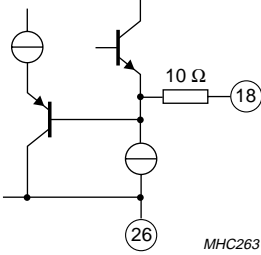
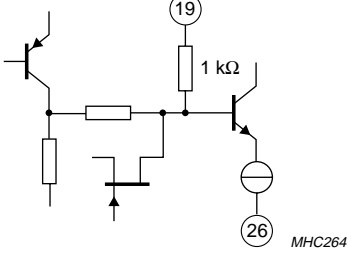
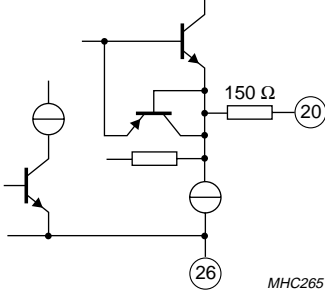
PIN	SYMBOL	EQUIVALENT CIRCUIT
16	PILFIL	 <p>MHC261</p>
17	$V_{AFL}$	 <p>MHC262</p>
18	$V_{AFR}$	 <p>MHC263</p>
19	TMUTE	 <p>MHC264</p>
20	MPXO	 <p>MHC265</p>

Low-power FM stereo radio for handheld applications

TEA5768HL

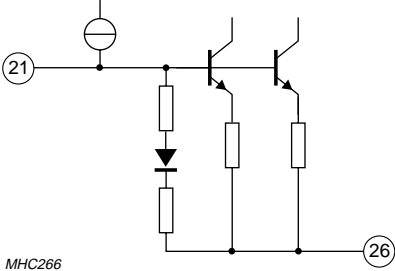
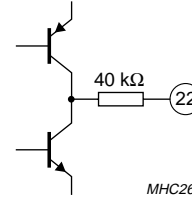
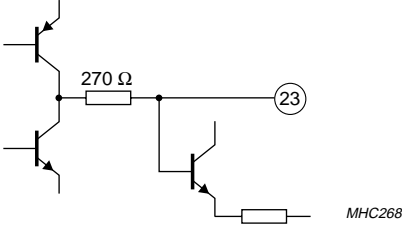
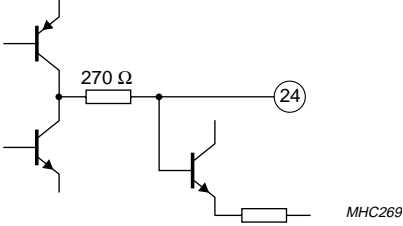
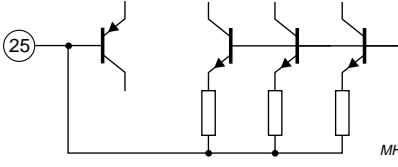
PIN	SYMBOL	EQUIVALENT CIRCUIT
21	$V_{ref}$	 <p>MHC266</p>
22	TIFC	 <p>MHC267</p>
23	LIMDEC1	 <p>MHC268</p>
24	LIMDEC2	 <p>MHC269</p>
25	$I_{gain}$	 <p>MHC270</p>
26	AGND	
27	$V_{CCA}$	

Low-power FM stereo radio for handheld applications

TEA5768HL

PIN	SYMBOL	EQUIVALENT CIRCUIT
28	RFI1	
29	RFGND	
30	RFI2	
31	TAGC	
32	LOOPSW	

14 APPLICATION INFORMATION

Table 28 Component list for Figs 1 and 5

COMPONENT	PARAMETER	VALUE	TOLERANCE	TYPE	MANUFACTURER
R1	resistor with low temperature coefficient	18 kΩ	±1 %	RC12G	Philips
D1 and D2	varicap for VCO tuning	–	–	BB202	Philips
L1	RF band filter coil	120 nH	±2 %	Q <sub>min</sub> = 40	
L2 and L3	VCO coil	33 nH	±2 %	Q <sub>min</sub> = 40	
XTAL13	13 MHz crystal	–	–	NX4025GA	
C <sub>pull</sub>	pulling capacitor for NX4025GA	10 pF	–		
XTAL32.768	32.768 kHz crystal	–	–		

# Low-power FM stereo radio for handheld applications

## TEA5768HL

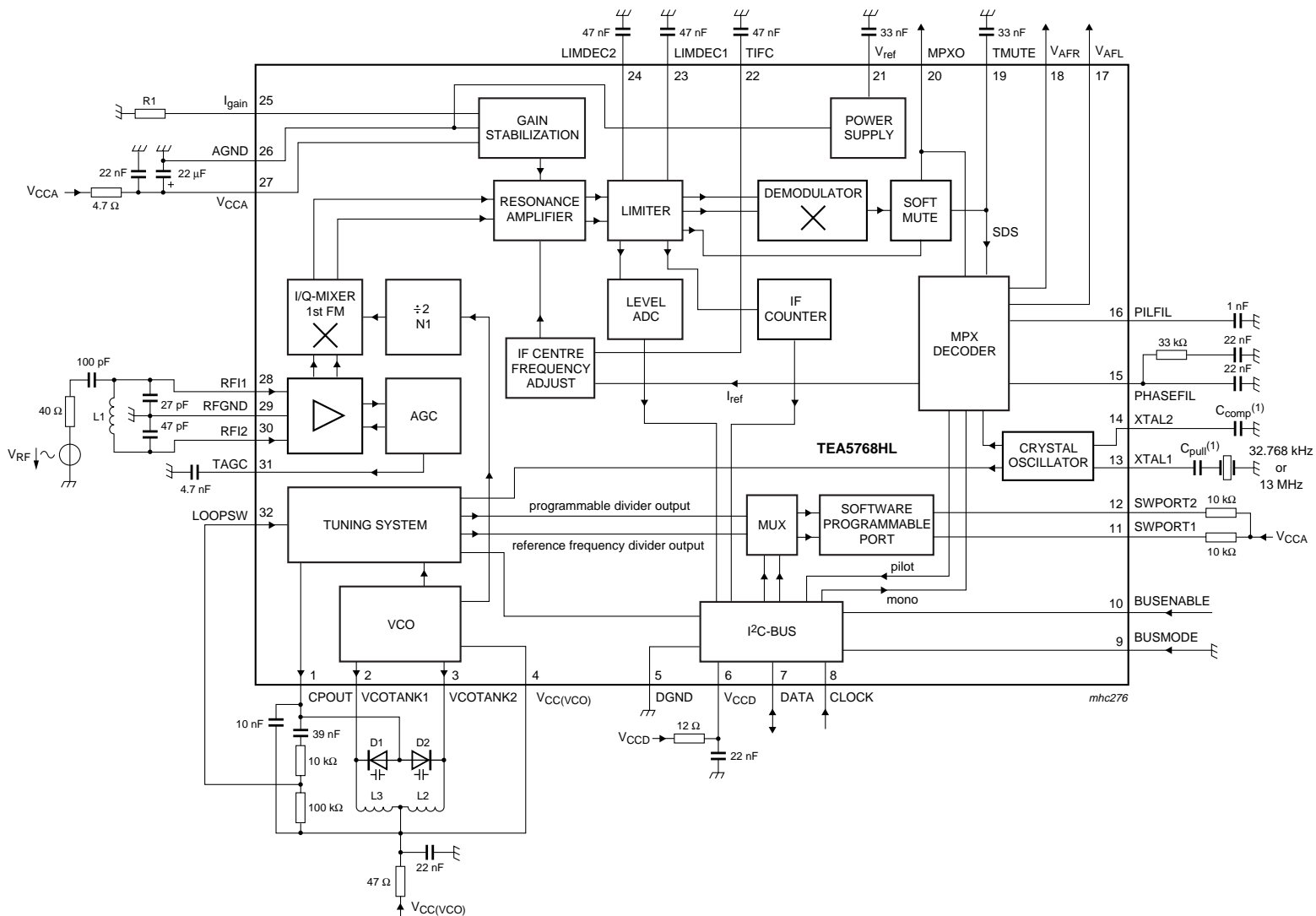

(1) C<sub>comp</sub> and C<sub>pull</sub> data depends on crystal specification.

Fig.5 Test circuit.

# Low-power FM stereo radio for handheld applications

## TEA5768HL

### 15 PACKAGE OUTLINE

LQFP32: plastic low profile quad flat package; 32 leads; body 7 x 7 x 1.4 mm

SOT358-1

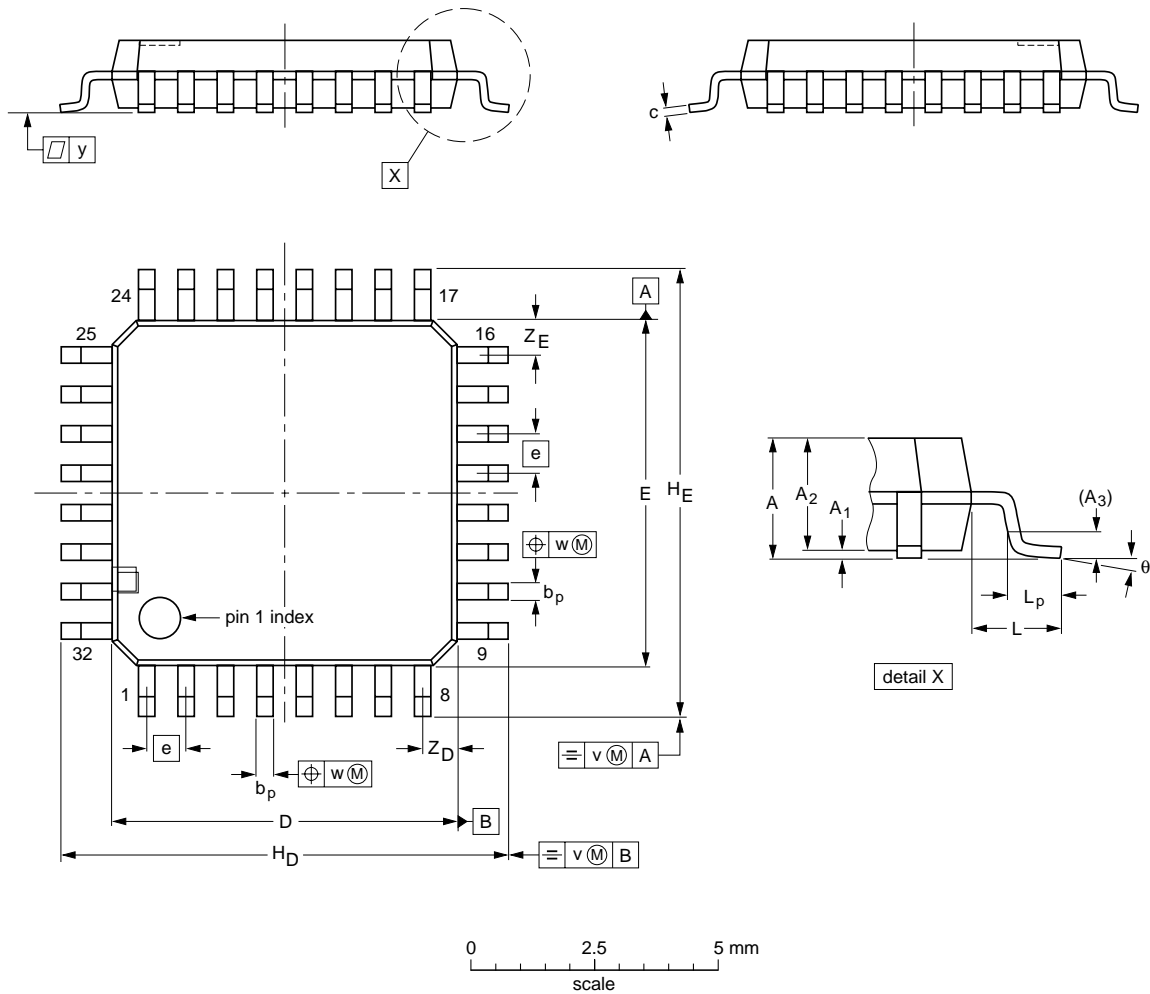

**DIMENSIONS (mm are the original dimensions)**

UNIT	A max.	A <sub>1</sub>	A <sub>2</sub>	A <sub>3</sub>	b <sub>p</sub>	c	D <sup>(1)</sup>	E <sup>(1)</sup>	e	H <sub>D</sub>	H <sub>E</sub>	L	L <sub>p</sub>	v	w	y	Z <sub>D</sub> <sup>(1)</sup>	Z <sub>E</sub> <sup>(1)</sup>	θ
mm	1.6	0.20 0.05	1.45 1.35	0.25	0.4 0.3	0.18 0.12	7.1 6.9	7.1 6.9	0.8	9.15 8.85	9.15 8.85	1	0.75 0.45	0.2	0.25	0.1	0.9 0.5	0.9 0.5	7° 0°

**Note**

1. Plastic or metal protrusions of 0.25 mm maximum per side are not included.

OUTLINE VERSION	REFERENCES				EUROPEAN PROJECTION	ISSUE DATE
	IEC	JEDEC	JEITA			
SOT358 -1	136E03	MS-026				00-01-19 03-02-25

## Low-power FM stereo radio for handheld applications

TEA5768HL

### 16 SOLDERING

#### 16.1 Introduction to soldering surface mount packages

This text gives a very brief insight to a complex technology. A more in-depth account of soldering ICs can be found in our *"Data Handbook IC26; Integrated Circuit Packages"* (document order number 9398 652 90011).

There is no soldering method that is ideal for all surface mount IC packages. Wave soldering can still be used for certain surface mount ICs, but it is not suitable for fine pitch SMDs. In these situations reflow soldering is recommended.

#### 16.2 Reflow soldering

Reflow soldering requires solder paste (a suspension of fine solder particles, flux and binding agent) to be applied to the printed-circuit board by screen printing, stencilling or pressure-syringe dispensing before package placement. Driven by legislation and environmental forces the worldwide use of lead-free solder pastes is increasing.

Several methods exist for reflowing; for example, convection or convection/infrared heating in a conveyor type oven. Throughput times (preheating, soldering and cooling) vary between 100 seconds and 200 seconds depending on heating method.

Typical reflow peak temperatures range from 215 °C to 270 °C depending on solder paste material. The top-surface temperature of the packages should preferably be kept:

- below 225 °C (SnPb process) or below 245 °C (Pb-free process)
  - for all BGA, HTSSON..T and SSOP..T packages
  - for packages with a thickness  $\geq 2.5$  mm
  - for packages with a thickness  $< 2.5$  mm and a volume  $\geq 350$  mm<sup>3</sup> so called thick/large packages.
- below 240 °C (SnPb process) or below 260 °C (Pb-free process) for packages with a thickness  $< 2.5$  mm and a volume  $< 350$  mm<sup>3</sup> so called small/thin packages.

Moisture sensitivity precautions, as indicated on packing, must be respected at all times.

#### 16.3 Wave soldering

Conventional single wave soldering is not recommended for surface mount devices (SMDs) or printed-circuit boards with a high component density, as solder bridging and non-wetting can present major problems.

To overcome these problems the double-wave soldering method was specifically developed.

If wave soldering is used the following conditions must be observed for optimal results:

- Use a double-wave soldering method comprising a turbulent wave with high upward pressure followed by a smooth laminar wave.
- For packages with leads on two sides and a pitch (e):
  - larger than or equal to 1.27 mm, the footprint longitudinal axis is **preferred** to be parallel to the transport direction of the printed-circuit board;
  - smaller than 1.27 mm, the footprint longitudinal axis **must** be parallel to the transport direction of the printed-circuit board.

The footprint must incorporate solder thieves at the downstream end.

- For packages with leads on four sides, the footprint must be placed at a 45° angle to the transport direction of the printed-circuit board. The footprint must incorporate solder thieves downstream and at the side corners.

During placement and before soldering, the package must be fixed with a droplet of adhesive. The adhesive can be applied by screen printing, pin transfer or syringe dispensing. The package can be soldered after the adhesive is cured.

Typical dwell time of the leads in the wave ranges from 3 seconds to 4 seconds at 250 °C or 265 °C, depending on solder material applied, SnPb or Pb-free respectively.

A mildly-activated flux will eliminate the need for removal of corrosive residues in most applications.

#### 16.4 Manual soldering

Fix the component by first soldering two diagonally-opposite end leads. Use a low voltage (24 V or less) soldering iron applied to the flat part of the lead. Contact time must be limited to 10 seconds at up to 300 °C.

When using a dedicated tool, all other leads can be soldered in one operation within 2 seconds to 5 seconds between 270 °C and 320 °C.



## Low-power FM stereo radio for handheld applications

TEA5768HL

### 16.5 Suitability of surface mount IC packages for wave and reflow soldering methods

PACKAGE <sup>(1)</sup>	SOLDERING METHOD	
	WAVE	REFLOW <sup>(2)</sup>
BGA, HTSSON..T <sup>(3)</sup> , LBGA, LFBGA, SQFP, SSOP..T <sup>(3)</sup> , TFBGA, VFBGA, XSON	not suitable	suitable
DHVQFN, HBCC, HBGA, HLQFP, HSO, HSOP, HSQFP, HSSON, HTQFP, HTSSOP, HVQFN, HVSON, SMS	not suitable <sup>(4)</sup>	suitable
PLCC <sup>(5)</sup> , SO, SOJ	suitable	suitable
LQFP, QFP, TQFP	not recommended <sup>(5)(6)</sup>	suitable
SSOP, TSSOP, VSO, VSSOP	not recommended <sup>(7)</sup>	suitable
CWQCCN..L <sup>(8)</sup> , PMFP <sup>(9)</sup> , WQCCN..L <sup>(8)</sup>	not suitable	not suitable

#### Notes

- For more detailed information on the BGA packages refer to the “(LF)BGA Application Note” (AN01026); order a copy from your Philips Semiconductors sales office.
- All surface mount (SMD) packages are moisture sensitive. Depending upon the moisture content, the maximum temperature (with respect to time) and body size of the package, there is a risk that internal or external package cracks may occur due to vaporization of the moisture in them (the so called popcorn effect). For details, refer to the Drypack information in the “Data Handbook IC26; Integrated Circuit Packages; Section: Packing Methods”.
- These transparent plastic packages are extremely sensitive to reflow soldering conditions and must on no account be processed through more than one soldering cycle or subjected to infrared reflow soldering with peak temperature exceeding  $217\text{ °C} \pm 10\text{ °C}$  measured in the atmosphere of the reflow oven. The package body peak temperature must be kept as low as possible.
- These packages are not suitable for wave soldering. On versions with the heatsink on the bottom side, the solder cannot penetrate between the printed-circuit board and the heatsink. On versions with the heatsink on the top side, the solder might be deposited on the heatsink surface.
- If wave soldering is considered, then the package must be placed at a  $45^\circ$  angle to the solder wave direction. The package footprint must incorporate solder thieves downstream and at the side corners.
- Wave soldering is suitable for LQFP, QFP and TQFP packages with a pitch (e) larger than 0.8 mm; it is definitely not suitable for packages with a pitch (e) equal to or smaller than 0.65 mm.
- Wave soldering is suitable for SSOP, TSSOP, VSO and VSSOP packages with a pitch (e) equal to or larger than 0.65 mm; it is definitely not suitable for packages with a pitch (e) equal to or smaller than 0.5 mm.
- Image sensor packages in principle should not be soldered. They are mounted in sockets or delivered pre-mounted on flex foil. However, the image sensor package can be mounted by the client on a flex foil by using a hot bar soldering process. The appropriate soldering profile can be provided on request.
- Hot bar soldering or manual soldering is suitable for PMFP packages.

# Low-power FM stereo radio for handheld applications

TEA5768HL

## 17 DATA SHEET STATUS

LEVEL	DATA SHEET STATUS <sup>(1)</sup>	PRODUCT STATUS <sup>(2)(3)</sup>	DEFINITION
I	Objective data	Development	This data sheet contains data from the objective specification for product development. Philips Semiconductors reserves the right to change the specification in any manner without notice.
II	Preliminary data	Qualification	This data sheet contains data from the preliminary specification. Supplementary data will be published at a later date. Philips Semiconductors reserves the right to change the specification without notice, in order to improve the design and supply the best possible product.
III	Product data	Production	This data sheet contains data from the product specification. Philips Semiconductors reserves the right to make changes at any time in order to improve the design, manufacturing and supply. Relevant changes will be communicated via a Customer Product/Process Change Notification (CPCN).

### Notes

1. Please consult the most recently issued data sheet before initiating or completing a design.
2. The product status of the device(s) described in this data sheet may have changed since this data sheet was published. The latest information is available on the Internet at URL <http://www.semiconductors.philips.com>.
3. For data sheets describing multiple type numbers, the highest-level product status determines the data sheet status.

## 18 DEFINITIONS

**Short-form specification** — The data in a short-form specification is extracted from a full data sheet with the same type number and title. For detailed information see the relevant data sheet or data handbook.

**Limiting values definition** — Limiting values given are in accordance with the Absolute Maximum Rating System (IEC 60134). Stress above one or more of the limiting values may cause permanent damage to the device. These are stress ratings only and operation of the device at these or at any other conditions above those given in the Characteristics sections of the specification is not implied. Exposure to limiting values for extended periods may affect device reliability.

**Application information** — Applications that are described herein for any of these products are for illustrative purposes only. Philips Semiconductors make no representation or warranty that such applications will be suitable for the specified use without further testing or modification.

## 19 DISCLAIMERS

**Life support applications** — These products are not designed for use in life support appliances, devices, or systems where malfunction of these products can reasonably be expected to result in personal injury. Philips Semiconductors customers using or selling these products for use in such applications do so at their own risk and agree to fully indemnify Philips Semiconductors for any damages resulting from such application.

**Right to make changes** — Philips Semiconductors reserves the right to make changes in the products - including circuits, standard cells, and/or software - described or contained herein in order to improve design and/or performance. When the product is in full production (status 'Production'), relevant changes will be communicated via a Customer Product/Process Change Notification (CPCN). Philips Semiconductors assumes no responsibility or liability for the use of any of these products, conveys no licence or title under any patent, copyright, or mask work right to these products, and makes no representations or warranties that these products are free from patent, copyright, or mask work right infringement, unless otherwise specified.

---

**Low-power FM stereo radio for  
handheld applications**

---

**TEA5768HL****20 PURCHASE OF PHILIPS I<sup>2</sup>C COMPONENTS**

Purchase of Philips I<sup>2</sup>C components conveys a license under the Philips' I<sup>2</sup>C patent to use the components in the I<sup>2</sup>C system provided the system conforms to the I<sup>2</sup>C specification defined by Philips. This specification can be ordered using the code 9398 393 40011.

# *Philips Semiconductors – a worldwide company*

## **Contact information**

For additional information please visit <http://www.semiconductors.philips.com>. Fax: +31 40 27 24825

For sales offices addresses send e-mail to: [sales.addresses@www.semiconductors.philips.com](mailto:sales.addresses@www.semiconductors.philips.com).

© Koninklijke Philips Electronics N.V. 2004

SCA76

All rights are reserved. Reproduction in whole or in part is prohibited without the prior written consent of the copyright owner.

The information presented in this document does not form part of any quotation or contract, is believed to be accurate and reliable and may be changed without notice. No liability will be accepted by the publisher for any consequence of its use. Publication thereof does not convey nor imply any license under patent- or other industrial or intellectual property rights.

Printed in The Netherlands

R30/03/pp36

Date of release: 2004 Sep 13

Document order number: 9397 750 13529

*Let's make things better.*

**Philips  
Semiconductors**



**PHILIPS**