

Product Overview

Qorvo's TGA2238 is a high power MMIC amplifier fabricated on Qorvo's production 0.25um GaN on SiC process (QGaN25). The TGA2238 operates from 8 – 11 GHz and provides a superior combination of power, gain and efficiency by achieving more than 60 W of saturated output power with 25 dB of large signal gain and more than 42% power-added efficiency.

This superior performance provides system designers the flexibility to improve system performance while reducing size and cost.

The TGA2238 is matched to 50Ω with integrated DC blocking capacitor on RF input port simplifying system integration. It is ideally suited for military and commercial x-band radar systems.

Lead-free and RoHS compliant.



Key Features

- Frequency Range: 8 – 11 GHz
- P_{OUT}: 48 dBm (P_{IN} = 23 dBm)
- PAE: 42% (P_{IN} = 23 dBm)
- Large Signal Gain: 25 dB
- Small Signal Gain: 31 dB
- Return Loss: >10 dB
- Bias: V_D = 28 V, I_{DQ} = 650 mA
- Chip Dimensions: 5.49 x 7.00 x 0.10 mm

Functional Block Diagram

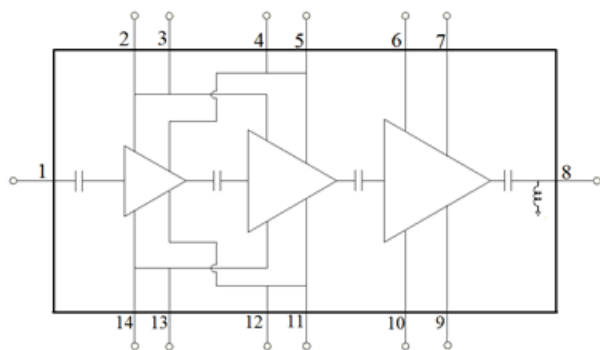

Applications

- X-band radar

Ordering Information

Part No.	Description
TGA2238	8 – 11 GHz 60 W GaN Power Amplifier
TGA2238EVB01	TGA2238 Evaluation Board

Absolute Maximum Ratings

Parameter	Rating
Drain Voltage (V_D)	40 V
Gate Voltage Range (V_G)	-8 to 0 V
Drain Current (I_D)	8 A
Gate Current (I_G)	See plot on page 7
Power Dissipation (P_{DISS}), 85°C, PW = 100us; DC = 10%	158 W
Input Power (P_{IN}), 50 Ω ., $V_D=25$ V, 85 °C, Pulsed: PW = 100 us; DC = 10%	30 dBm
Input Power (P_{IN}), VSWR 3:1: $V_D=25$ V, 85 °C, PW = 100 us; DC = 10%	30 dBm
Mounting Temperature (30 seconds)	320 °C
Storage Temperature	-55 to 150 °C

Exceeding any one or a combination of the Absolute Maximum Rating conditions may cause permanent damage to the device. Extended application of Absolute Maximum Rating conditions to the device may reduce device reliability.

Recommended Operating Conditions

Parameter	Typ.	Units
Drain Voltage (V_D)	28 V	V
Drain Current, Quiescent (I_{DQ})	650 mA	mA
Operating Temperature Range	-40 to 85	°C

Electrical specifications are measured at specified test conditions. Specifications are not guaranteed over all recommended operating conditions.

Electrical Specifications

Parameter	Min	Typ	Max	Units
Operational Frequency Range	8		11	GHz
Output Power ($P_{in} = 23$ dBm)		48		dBm
Power Added Efficiency ($P_{in} = 23$ dBm)		42		%
Power Gain ($P_{in} = 23$ dBm)		25		dB
Power @ 1dB Compression (P_{1dB})		36		dBm
Small Signal Gain		31		dB
Input Return Loss		15		dB
Output Return Loss		15		dB
Small Signal Gain Temperature Coefficient		-0.058		dB/°C
Output Power Temperature Coefficient		-0.014		dBm/°C

Test conditions unless otherwise noted: 25 °C , $V_D = 28$ V, $I_{DQ} = 650$ mA, PW = 100 us, DC = 10%

Performance Plots – Large Signal (Pulsed)

Test conditions unless otherwise noted: 25 °C , $V_D = 28\text{ V}$, $I_{DQ} = 650\text{ mA}$, $P_{IN} = 23\text{ dBm}$, $PW = 100\text{ }\mu\text{s}$, $DC = 10\%$

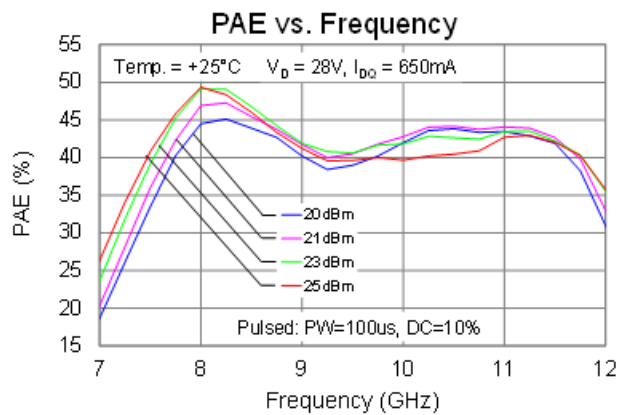
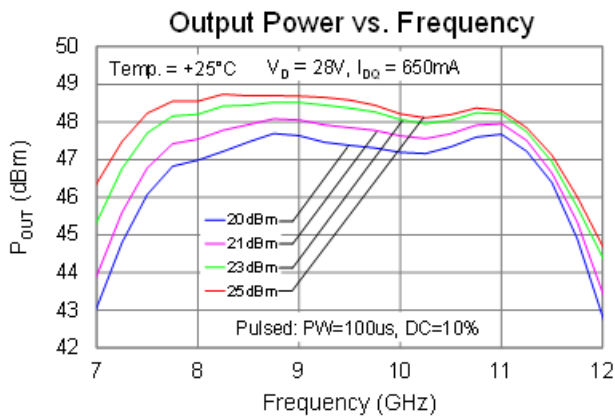
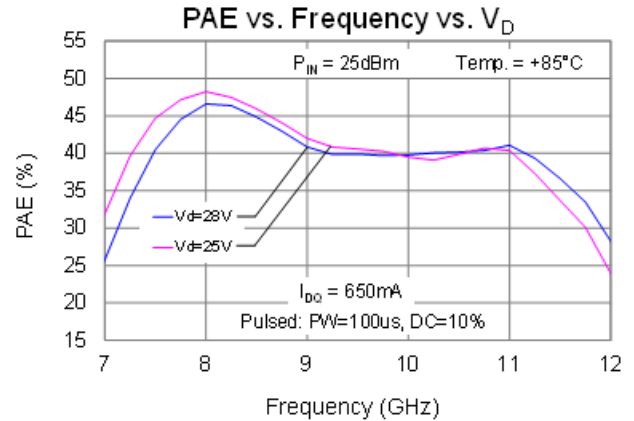
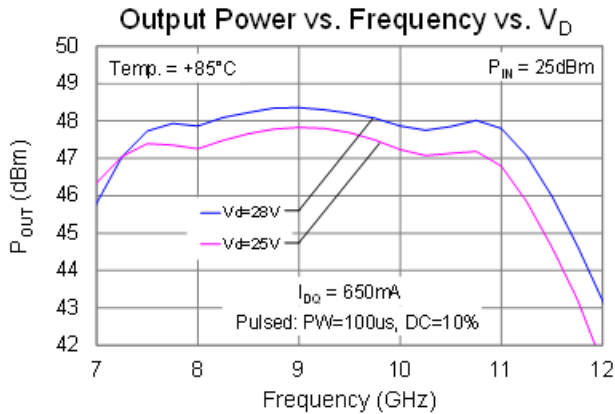
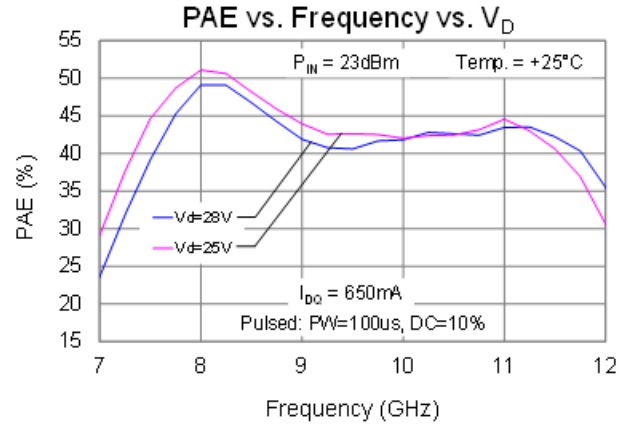
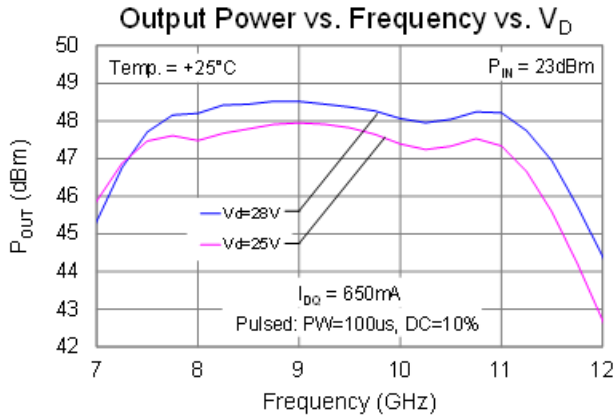

Performance Plots – Large Signal (Pulsed)

Test conditions unless otherwise noted: 25 °C , $V_D = 28\text{ V}$, $I_{DQ} = 650\text{ mA}$, $P_{IN} = 23\text{ dBm}$, $PW = 100\text{ }\mu\text{s}$, $DC = 10\%$

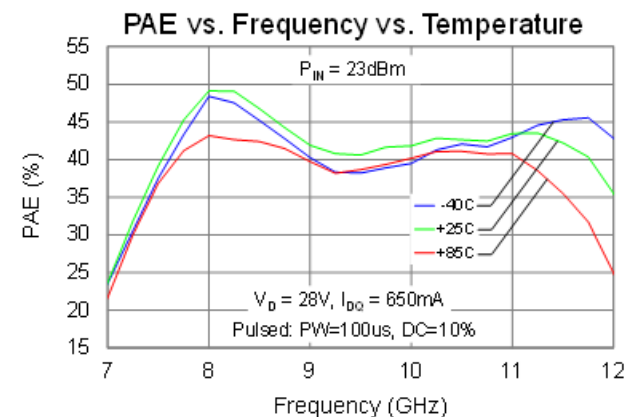
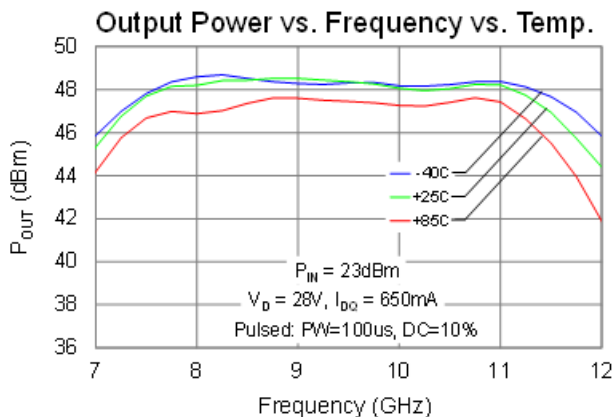
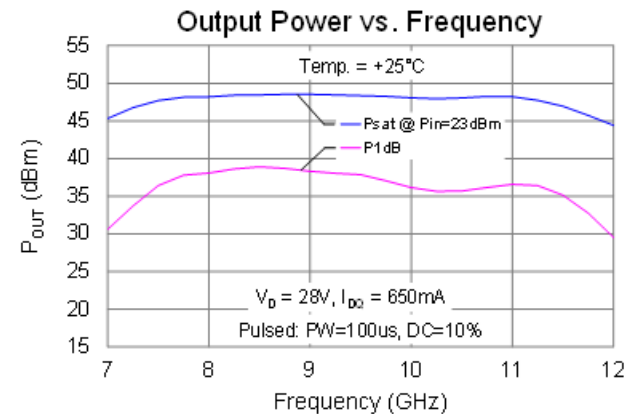
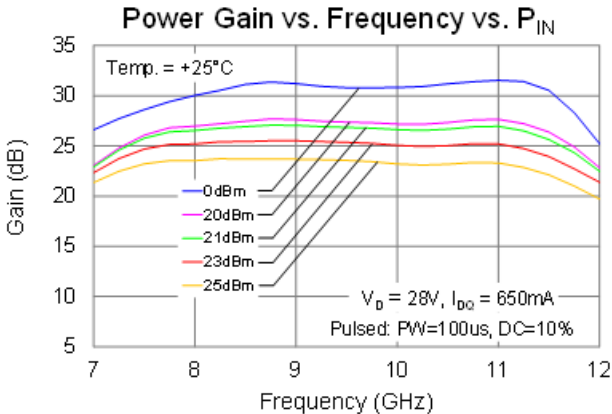
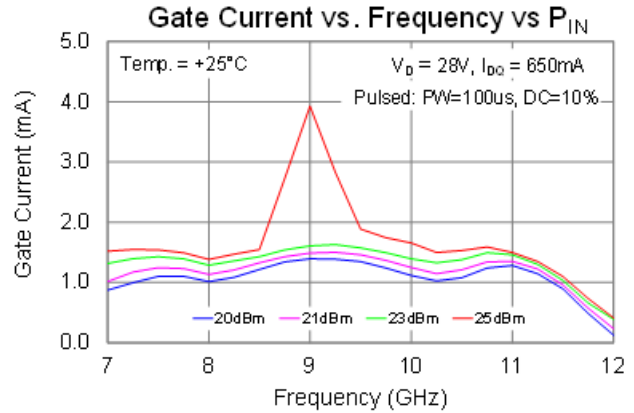
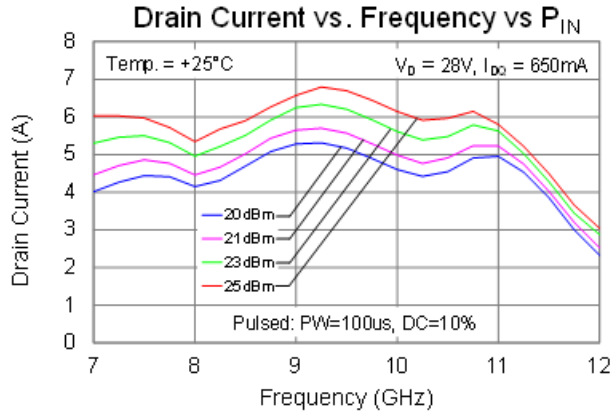

Performance Plots – Large Signal (Pulsed)

Test conditions unless otherwise noted: 25 °C , $V_D = 28\text{ V}$, $I_{DQ} = 650\text{ mA}$, $P_{IN} = 23\text{ dBm}$, $PW = 100\text{ us}$, $DC = 10\%$

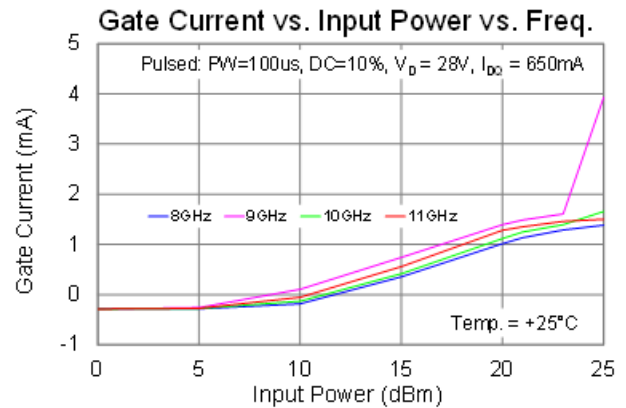
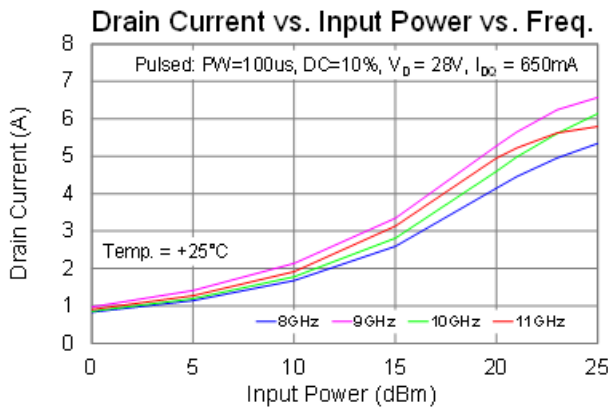
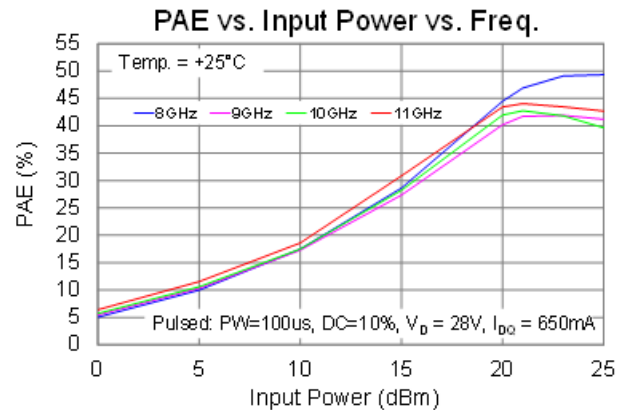
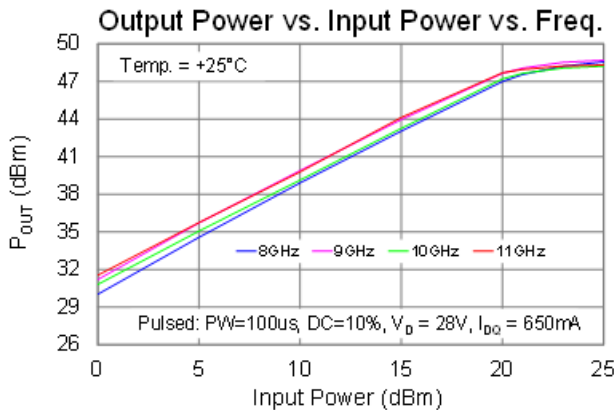
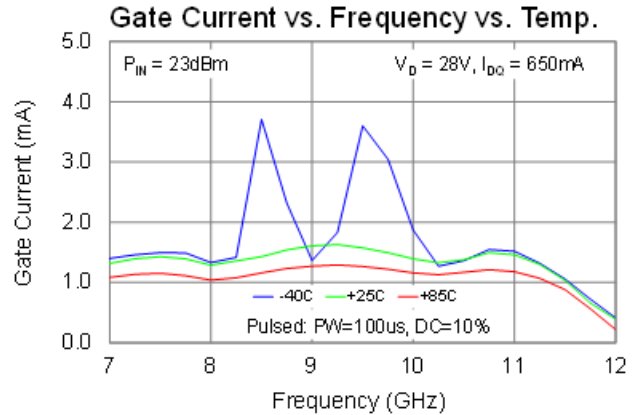
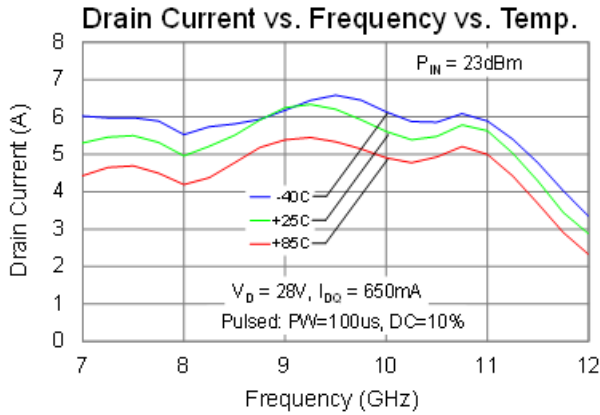

Performance Plots – Small Signal

Test conditions unless otherwise noted: 25 °C , $V_D = 28\text{ V}$, $I_{DQ} = 650\text{ mA}$, CW

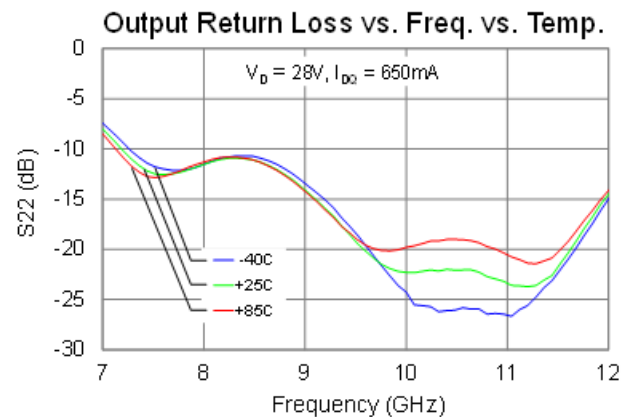
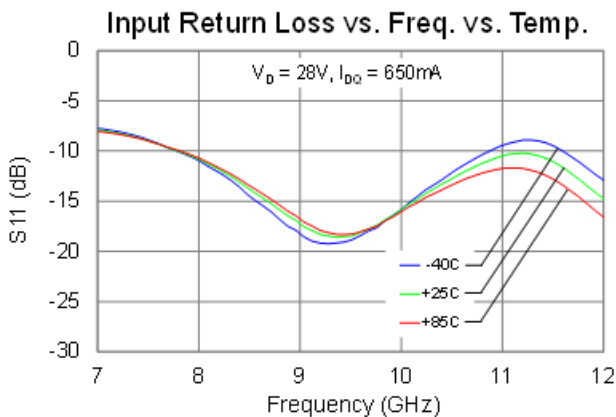
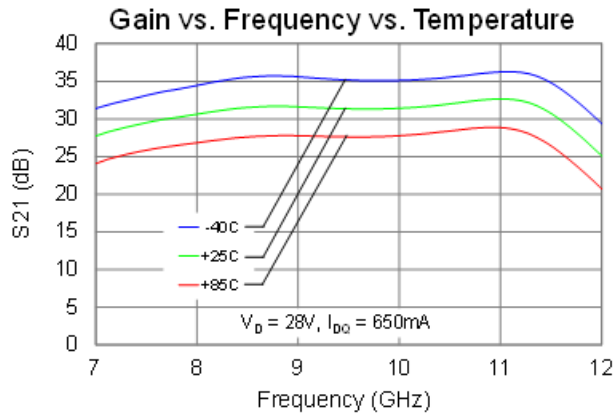
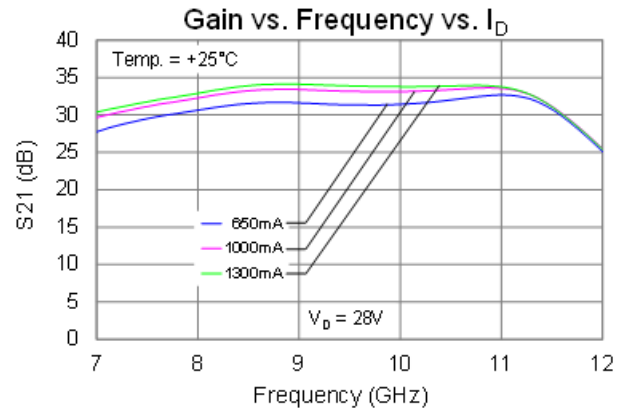
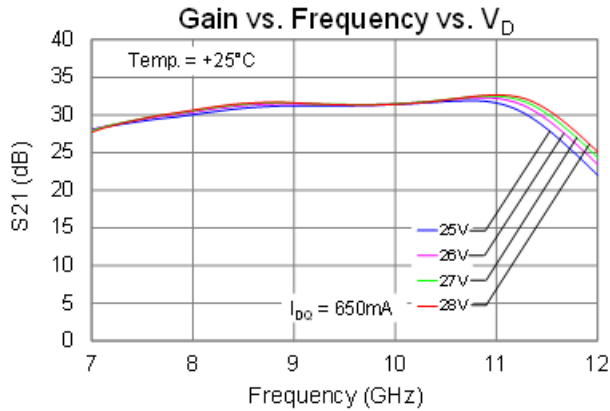

Thermal and Reliability Information

Parameter	Test Conditions	Value	Units
Thermal Resistance (θ_{JC}) ⁽¹⁾	$T_{base} = 85\text{ }^\circ\text{C}$, $PW = 100\text{ }\mu\text{s}$, $DC = 10\%$, $V_D = 25\text{ V}$, $I_{D_Drive} = 6\text{ A}$, $Freq = 9.25\text{ GHz}$, $P_{IN} = 25\text{ dBm}$, $P_{OUT} = 47.8\text{ dBm}$, $P_{DISS} = 92\text{ W}$	0.57	$^\circ\text{C/W}$
Channel Temperature (T_{CH}) (Quiescent) ⁽²⁾		137	$^\circ\text{C}$
Thermal Resistance (θ_{JC}) ⁽¹⁾	$T_{base} = 85\text{ }^\circ\text{C}$, $PW = 100\text{ }\mu\text{s}$, $DC = 10\%$, $V_D = 28\text{ V}$, $I_{D_Drive} = 6.3\text{ A}$, $Freq = 9.25\text{ GHz}$, $P_{IN} = 25\text{ dBm}$, $P_{OUT} = 48.3\text{ dBm}$, $P_{DISS} = 107\text{ W}$	0.58	$^\circ\text{C/W}$
Channel Temperature (T_{CH}) (RF Drive) ⁽²⁾		147	$^\circ\text{C}$

Notes:

1. Thermal resistance determined to the back of a 20 mil Cu-Mo carrier plate with eutectic die attach (85 $^\circ\text{C}$)
2. IR Scan equivalent channel temperature. Refer to the following document: [GaN Device Channel Temperature, Thermal Resistance, and Reliability Estimates](#)

Power Dissipation and Maximum Gate Current

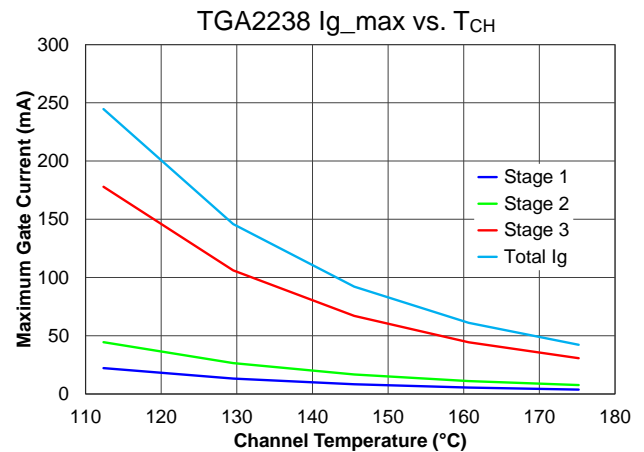
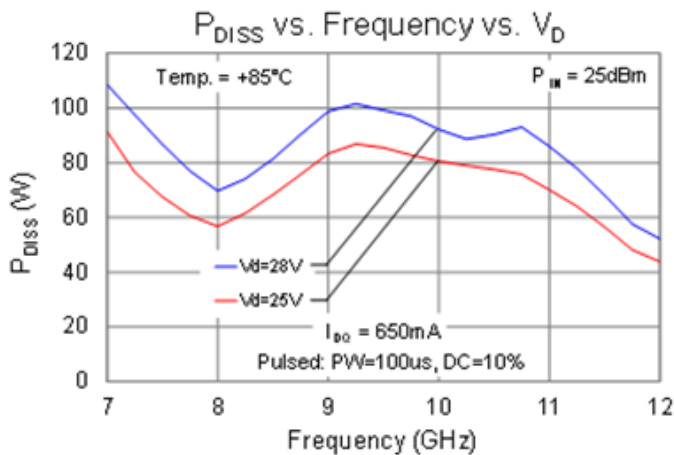

Applications Information

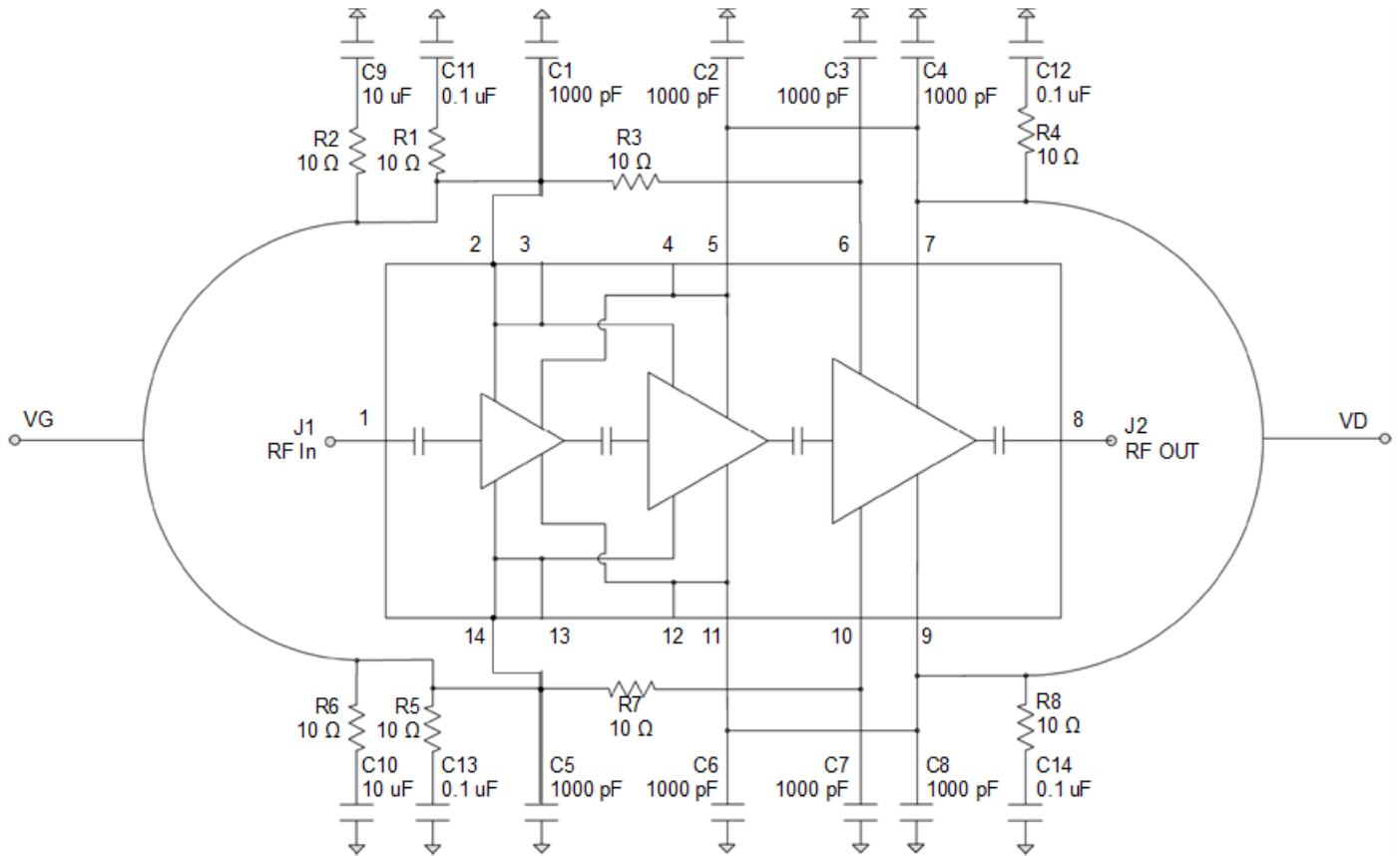

Notes:

1. V_G & V_D need to be biased from both sides.

Bias-Up Procedure

1. Set I_D limit to 8000 mA, I_G limit to 20 mA
2. Set V_G to -5.0 V
4. Set V_D +28 V
5. Adjust V_G more positive until $I_{DQ} \approx 650$ mA
6. Apply RF signal

Bias-Down Procedure

1. Turn off RF signal
2. Reduce V_G to -5.0 V. Ensure $I_{DQ} \sim 0$ mA
4. Set V_D to 0 V
5. Turn off V_D supply
6. Turn off V_G supply

Evaluation Board (EVB) Layout Assembly

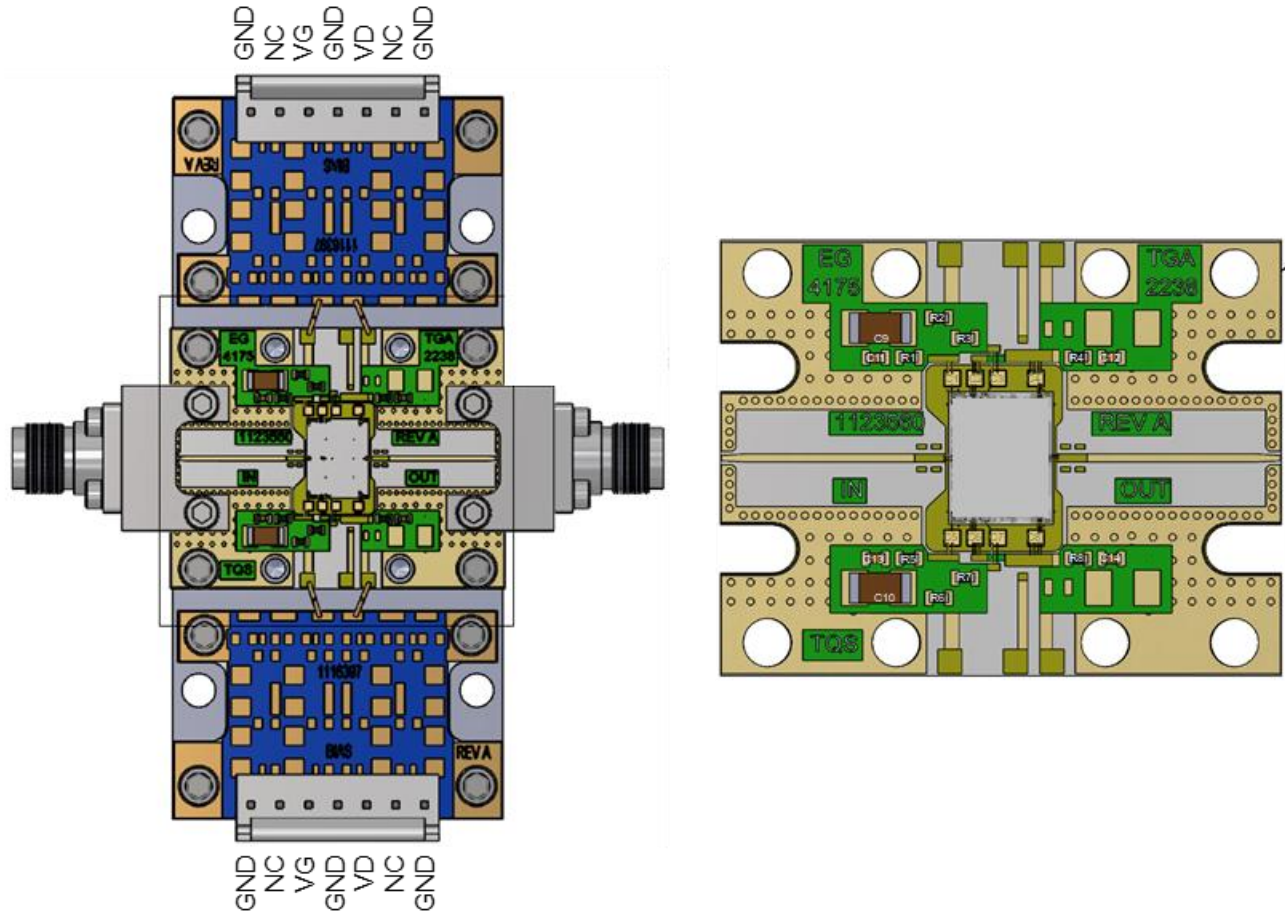

Bill of Materials

Reference Des.	Value	Description	Manuf.	Part Number
C1 – C8	1000 pF	Cap, 1000 pF, 10%, 50V, BORDER, SL	Various	Various
C9 – C10	10 uF	Cap, 10 uF, 20%, 50V, X5R, 1206	Various	Various
C11 – C14	0.1 uF	Cap, 0.1 uF, 10%, 50V, X7R, 0402	Various	Various
R1 – R8	10 Ω	Res, 10 Ohm, 5%, 0.1 W, 0402	Various	Various
J1, J2	2.92 mm	RF Connector, 2.92 mm (F)	Southwest Microwave	1092-01A-5

Mechanical Information and Bond Pad Description

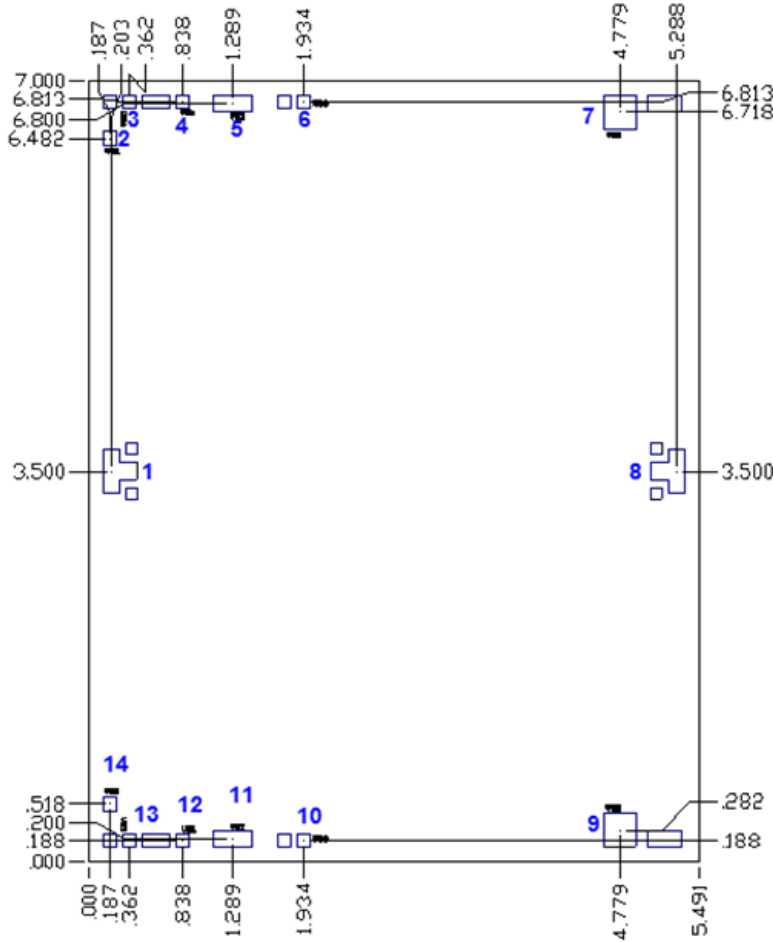

Units: millimeters
 Thickness: 0.100
 Die x,y size tolerance: ± 0.050
 Chip edge to bond pad dimensions are shown to center of pad
 Ground is backside of die

Bond Pad Description

Pad No.	Symbol	Pad Size (mm)	Description
1	RF Input	0.146 x 0.386	RF Input; matched to 50Ω; DC blocked
2, 14	VG1	0.121 x 0.121	VG1 and VG2 are internally connected so either one can be used for both VG1 or VG2, bias network is required; see Application Circuit on page 8 as an example.
3, 13	VG2	0.121 x 0.121	
4, 12	VD1	0.121 x 0.121	VD1 and VD2 are internally connected so either one can be used for both VD1 or VD2, bias network is required; see Application Circuit on page 8 as an example.
5, 11	VD2	0.346 x 0.146	
6, 10	VG3	0.121 x 0.121	VG3, bias network is required; see Application Circuit on page 8 as an example.
7, 9	VD3	0.296 x 0.310	VD 3, bias network is required; see Application Circuit on page 8 as an example.
8	RF Output	0.146 x 0.386	RF Output; matched to 50Ω; DC shorted to ground

Assembly Notes

Component placement and die attachment assembly notes:

- Vacuum pencils and/or vacuum collets are the preferred method of pick up.
- Air bridges must be avoided during placement.
- The force impact is critical during auto placement.
- Conductive epoxy attachment may be used for small-signal low power dissipation die.
- Follow manufacture instructions for epoxy curing.

Reflow process assembly notes:

- Use AuSn (80/20) solder and limit exposure to temperatures above 300°C to 3-4 minutes, maximum.
- An alloy station or conveyor furnace with reducing atmosphere should be used.
- Do not use any kind of flux.
- Coefficient of thermal expansion matching is critical for long-term reliability.
- Devices must be stored in a dry nitrogen atmosphere.

Interconnect process assembly notes:

- Thermosonic ball bonding is the preferred interconnect technique.
- Force, time, and ultrasonic are critical parameters.
- Aluminum wire should not be used.
- Devices with small pad sizes should be bonded with 0.0007-inch wire.

Handling Precautions

Parameter	Rating	Standard
ESD – Human Body Model (HBM)	1B	JEDEC Standard JESD22 A114



Caution!
 ESD-Sensitive Device

RoHS Compliance

This part is compliant with 2011/65/EU RoHS directive (Restrictions on the Use of Certain Hazardous Substances in Electrical and Electronic Equipment) as amended by Directive 2015/863/EU.

This product also has the following attributes:

- Lead Free
- Halogen Free (Chlorine, Bromine)
- Antimony Free
- TBBP-A (C₁₅H₁₂Br₄O₂) Free
- SVHC Free
- PFOS Free

Contact Information

For the latest specifications, additional product information, worldwide sales and distribution locations:

Web: www.qorvo.com

Tel: 1-844-890-8163

Email: customer.support@qorvo.com

Important Notice

The information contained in this Data Sheet and any associated documents (“Data Sheet Information”) is believed to be reliable; however, Qorvo makes no warranties regarding the Data Sheet Information and assumes no responsibility or liability whatsoever for the use of said information. All Data Sheet Information is subject to change without notice. Customers should obtain and verify the latest relevant Data Sheet Information before placing orders for Qorvo® products. Data Sheet Information or the use thereof does not grant, explicitly, implicitly or otherwise any rights or licenses to any third party with respect to patents or any other intellectual property whether with regard to such Data Sheet Information itself or anything described by such information.

DATA SHEET INFORMATION DOES NOT CONSTITUTE A WARRANTY WITH RESPECT TO THE PRODUCTS DESCRIBED HEREIN, AND QORVO HEREBY DISCLAIMS ANY AND ALL WARRANTIES WITH RESPECT TO SUCH PRODUCTS WHETHER EXPRESS OR IMPLIED BY LAW, COURSE OF DEALING, COURSE OF PERFORMANCE, USAGE OF TRADE OR OTHERWISE, INCLUDING THE IMPLIED WARRANTIES OF MERCHANTABILITY AND FITNESS FOR A PARTICULAR PURPOSE. Without limiting the generality of the foregoing, Qorvo® products are not warranted or authorized for use as critical components in medical, life-saving, or life-sustaining applications, or other applications where a failure would reasonably be expected to cause severe personal injury or death. Applications described in the Data Sheet Information are for illustrative purposes only. Customers are responsible for validating that a particular product described in the Data Sheet Information is suitable for use in a particular application.

© 2023 Qorvo US, Inc. All rights reserved. This document is subject to copyright laws in various jurisdictions worldwide and may not be reproduced or distributed, in whole or in part, without the express written consent of Qorvo US, Inc. | QORVO® is a registered trademark of Qorvo US, Inc.