

Applications

- Commercial and Military Radar
- Communications
- Electronic Warfare (EW)

Product Features

- Frequency Range: 2-6 GHz
- Output Power: > 31.5 dBm ($P_{IN} = 18$ dBm)
- PAE: > 31 % ($P_{IN} = 18$ dBm)
- Large Signal Gain: > 13.5 dB ($P_{IN} = 18$ dBm)
- Small Signal Gain: > 24 dB
- $V_D = 25$ V, $I_{DQ} = 40$ mA, $V_G = -2.5$ V typ.
- Chip Dimensions: 2.140 mm x 1.500 mm x 0.10 mm

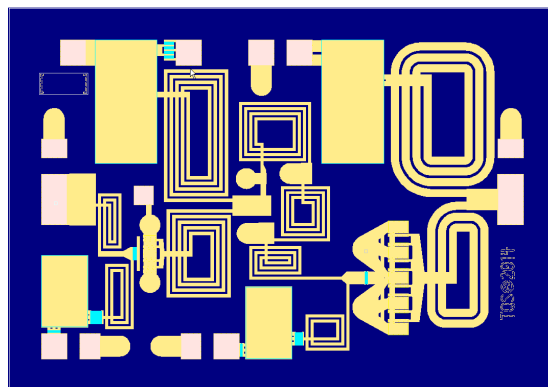

Functional Block Diagram

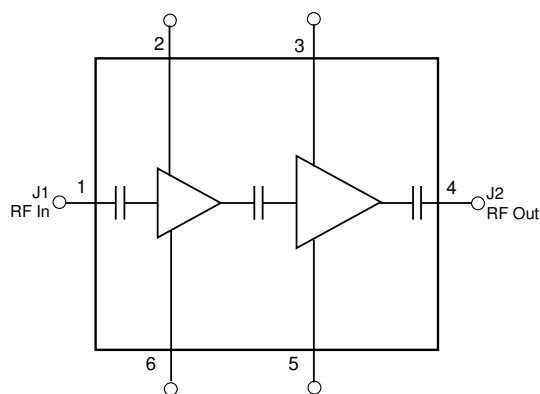

General Description

TriQuint's TGA2597 is a driver amplifier fabricated on TriQuint's TQGaN25 0.25um GaN on SiC production process. The TGA2597 operates from 2.0 to 6.0 GHz and provides > 31.5 dBm of output power with > 13.5 dB of large signal gain and > 31 % power-added efficiency.

The TGA2597 operates with the same drain bias as corresponding GaN HPA's making it an ideal driver amplifier. It can also function as the output amplifier in lower power applications. The TGA2597 is internally matched to 50 ohms, and includes integrated DC blocks on both RF ports allowing for simple system integration.

Lead-free and RoHS compliant.

Evaluation boards are available upon request.

Pad Configuration

Pad No.	Symbol
1	RF In
2	V_{D1}
3	V_{D2}
4	RF Out
5	V_{G2}
6	V_{G1}

Ordering Information

Part	ECCN	Description
TGA2597	EAR99	2-6 GHz GaN Driver Amplifier

Absolute Maximum Ratings

Parameter	Value
Drain Voltage (V_D)	40 V
Gate Voltage Range (V_G)	-8 to 0 V
Drain Current w/ RF Drive (I_{D_DRIVE}):	
1 st Stage (I_{D1_DRIVE})	95 mA
2 nd Stage (I_{D2_DRIVE})	305 mA
Gate Current (I_G):	
1 st Stage (I_{G1}) (+ I_{G1} @ $T_{CH}=200$ °C)	-0.2 / 1.4 mA
2 nd Stage (I_{G2}) (+ I_{G2} @ $T_{CH}=200$ °C)	-0.64 / 2.8 mA
Power Dissipation (P_{DISS})	5.4 W
Input Power, CW, 50 Ω (P_{IN}) ¹	24 dBm
Input Power, CW, 3:1 VSWR (P_{IN}) ¹	24 dBm
Channel temperature (T_{CH})	275 °C
Mounting Temperature (30 Seconds maximum)	320 °C
Storage Temperature	-55 to 150 °C
Notes:	
1. $V_D = 25$ V, $I_{DQ} = 40$ mA, $T_{BASE} = 85$ °C	

Operation of this device outside the parameter ranges given above may cause permanent damage. These are stress ratings only, and functional operation of the device at these conditions is not implied.

Recommended Operating Conditions

Parameter	Value
Drain Voltage (V_D)	25 V
Drain Current (I_{DQ})	40 mA
Drain Current w/ RF Drive (I_{D_DRIVE})	250 mA
Gate Voltage (V_G), typ.	-2.5 V

Electrical specifications are measured at specified test conditions. Specifications are not guaranteed over all operating conditions.

Electrical Specifications

Test conditions unless otherwise noted: 25 °C, $V_D = 25$ V, $I_{DQ} = 40$ mA, $V_G = -2.5$ V typ., die mounted to EVB

Parameter	Min	Typical	Max	Units
Operating Frequency Range	2.0		6.0	GHz
Output Power (@ $P_{in} = 18$ dBm)		> 31.5		dBm
Power Added Efficiency (@ $P_{in} = 18$ dBm)		> 31		%
Small Signal Gain		> 24		dB
Input Return Loss		> 15		dB
Output Return Loss		> 5		dB
IM3 ($P_{out}/Tone \leq 24$ dBm, 10 MHz tone spacing)		< -25		dBc
Small Signal Gain Temperature Coefficient		-0.050		dB/°C
Output Power Temperature Coefficient		-0.001		dB/°C

Thermal and Reliability Information

Parameter	Test Conditions	Value	Units
Thermal Resistance (θ_{JC}) ⁽¹⁾	$T_{PKG} = 85^\circ\text{C}$, $V_D = 25\text{ V}$, $I_{DQ} = 40\text{ mA}$, $I_{D_DRIVE} = 208\text{ mA}$, $P_{IN} = 18\text{ dBm}$, $P_{OUT} =$ 32.5 dBm , $P_{DISS} = 3.5\text{ W}$	17.14	$^\circ\text{C/W}$
Channel Temperature (T_{CH})		145	$^\circ\text{C}$
Median Lifetime (T_M)		3.07E09	Hrs

Notes:

- MMIC soldered to 40 mil thick Cu-Mo carrier plate using 1.5 mil thick AuSn solder. Thermal resistance is determined from the channel to the back of the carrier plate (fixed 85 $^\circ\text{C}$ temp.).

Median Lifetime

Test Conditions: 40 V; Failure Criteria = 10% reduction in I_{D_MAX}

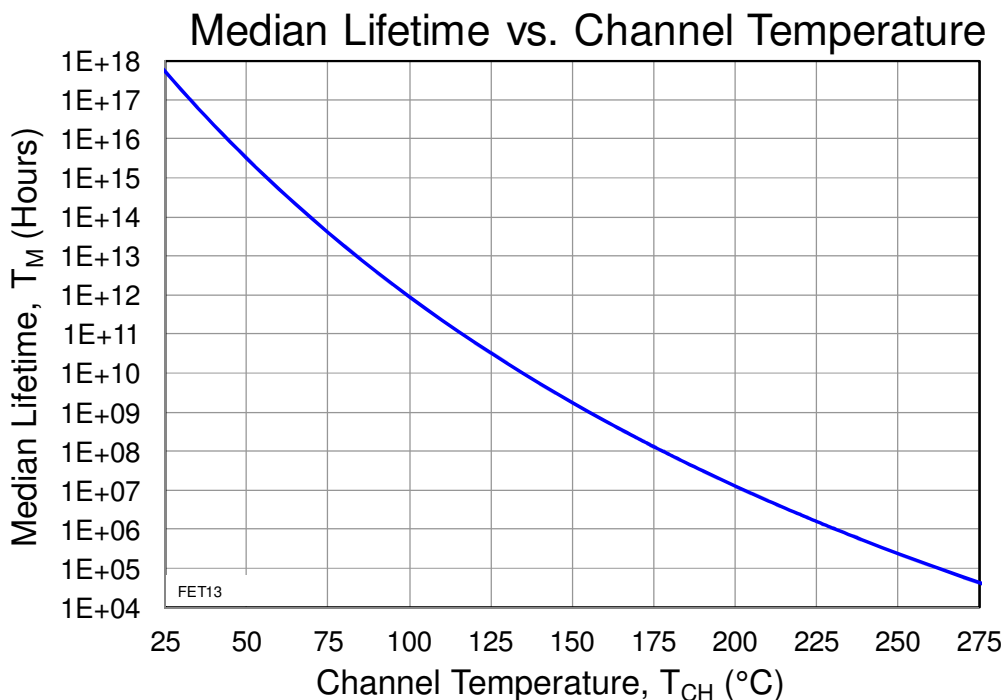

Typical Performance – Small Signal

Test conditions unless otherwise noted: 25 °C, $V_D = 25\text{ V}$, $I_{DQ} = 40\text{ mA}$, $V_G = -2.5\text{ V typ.}$, die mounted to EVB

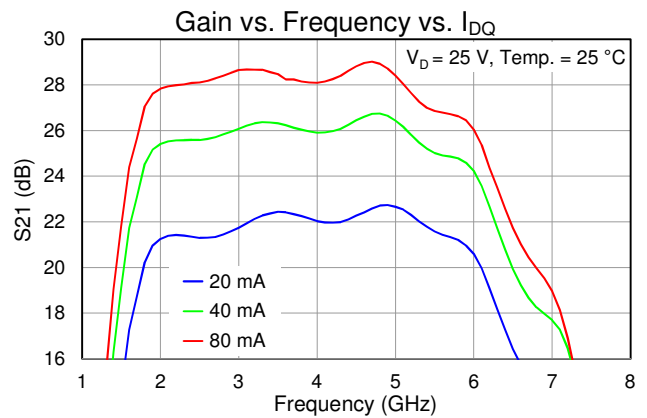
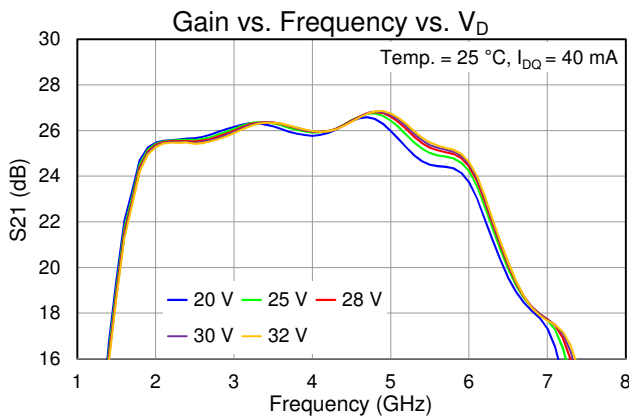
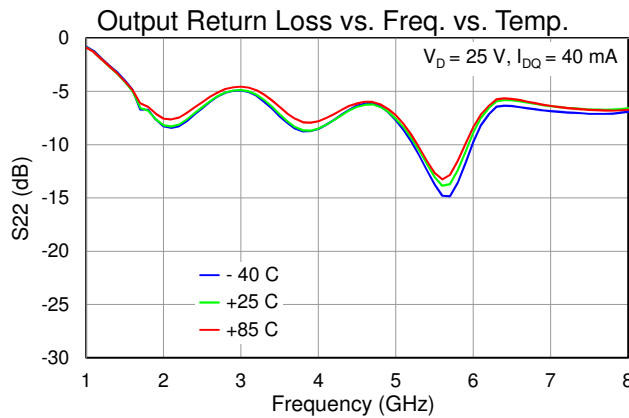
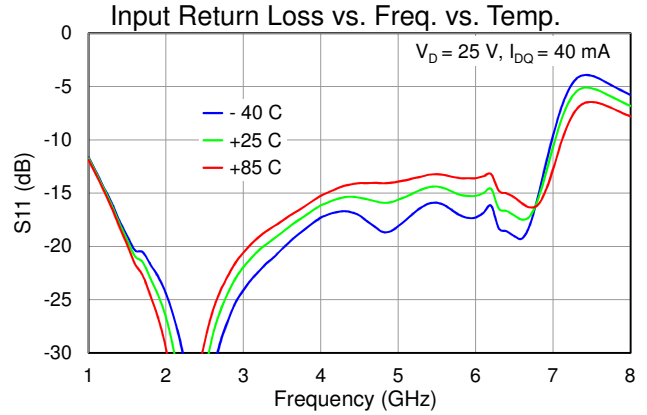
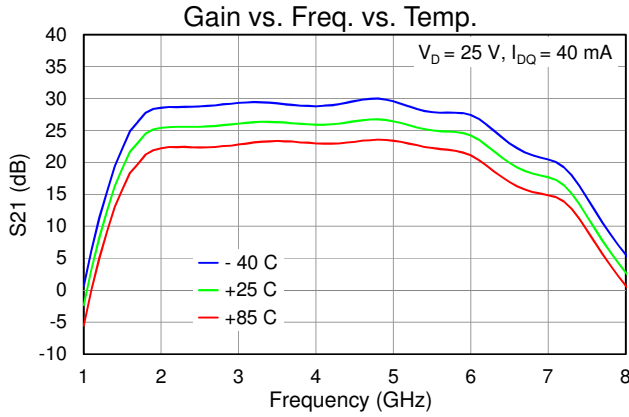

Typical Performance – Large Signal

Test conditions unless otherwise noted: 25 °C, $V_D = 25$ V, $I_{DQ} = 40$ mA, $V_G = -2.5$ V typ., die mounted to EVB

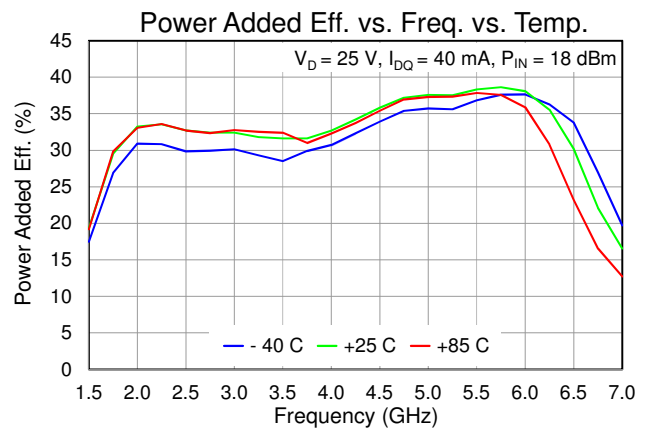
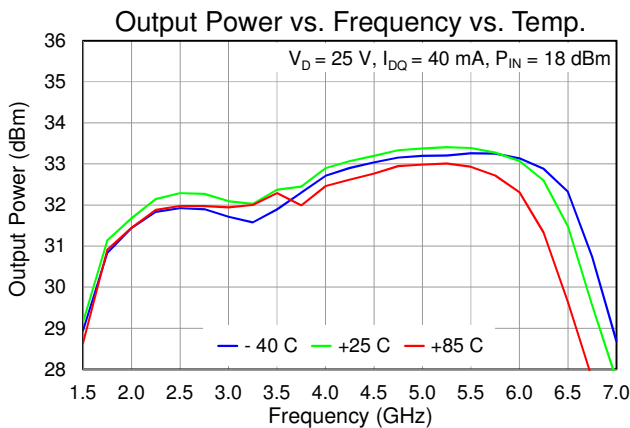
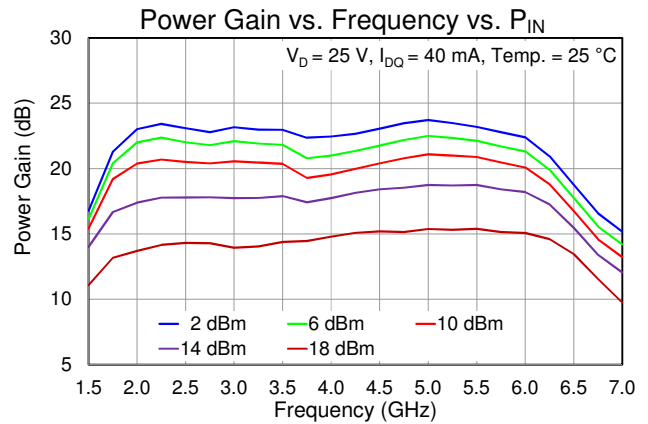
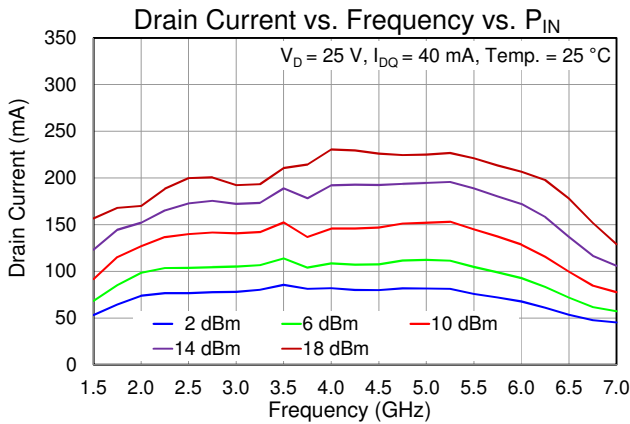
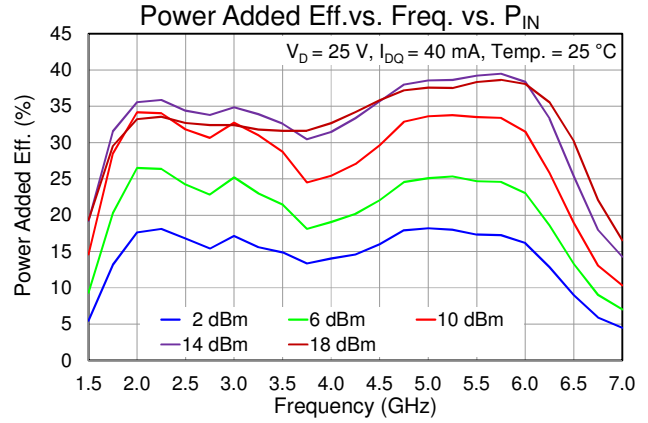
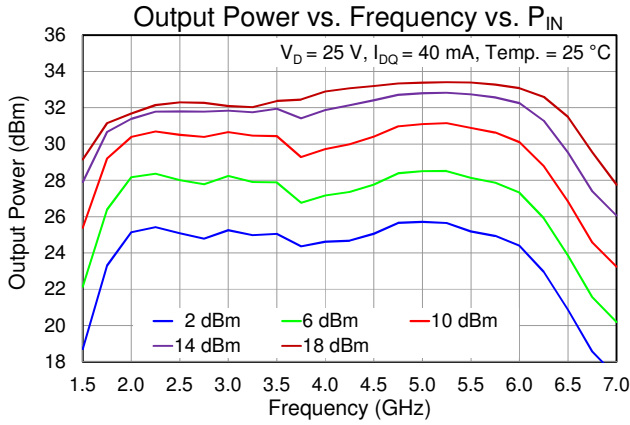

Typical Performance – Large Signal

Test conditions unless otherwise noted: 25 °C, $V_D = 25\text{ V}$, $I_{DQ} = 40\text{ mA}$, $V_G = -2.5\text{ V typ.}$, die mounted to EVB

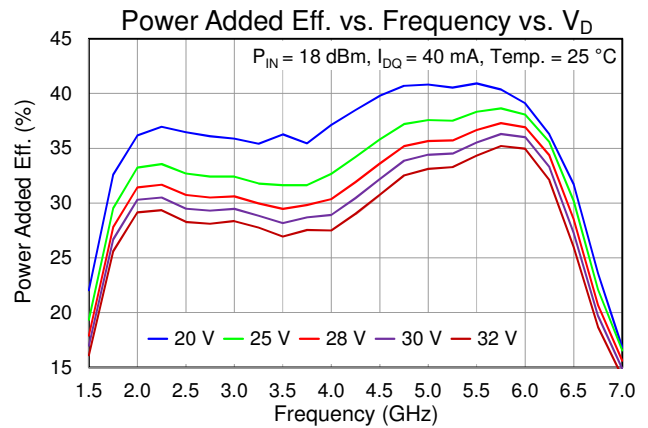
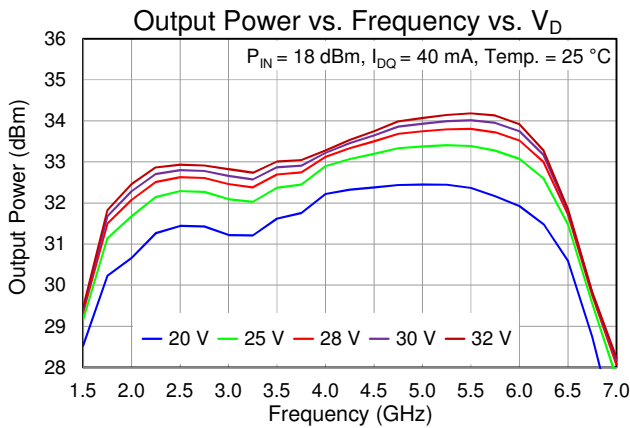
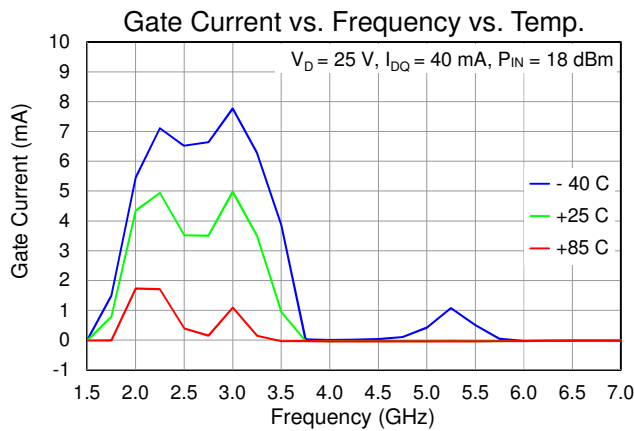
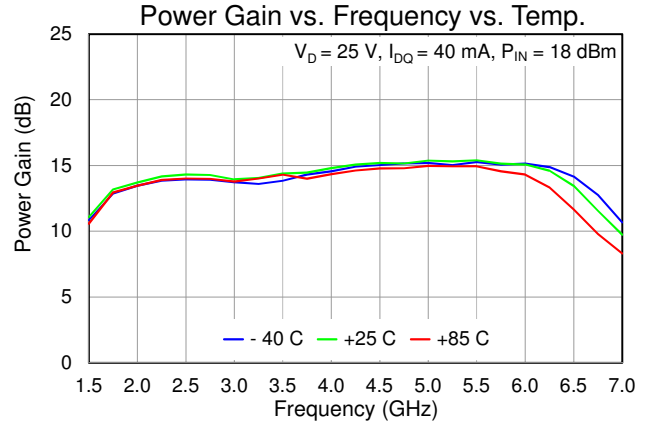
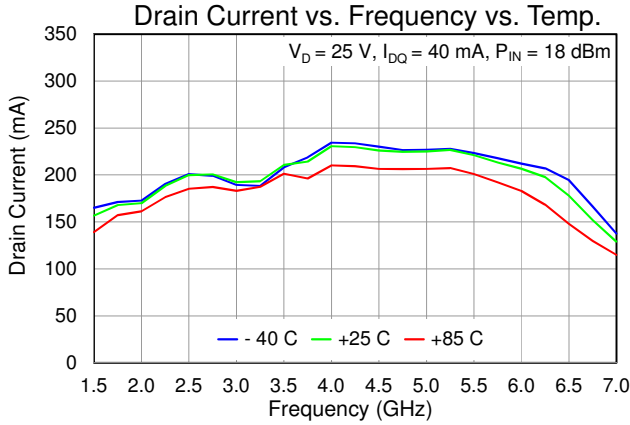

Typical Performance – Large Signal

Test conditions unless otherwise noted: 25 °C, $V_D = 25$ V, $I_{DQ} = 40$ mA, $V_G = -2.5$ V typ., die mounted to EVB

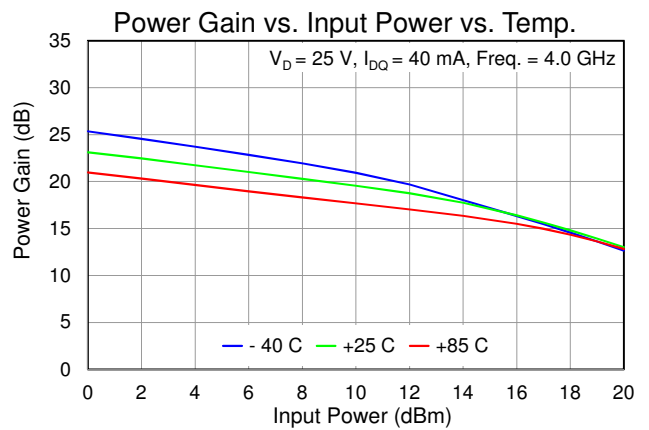
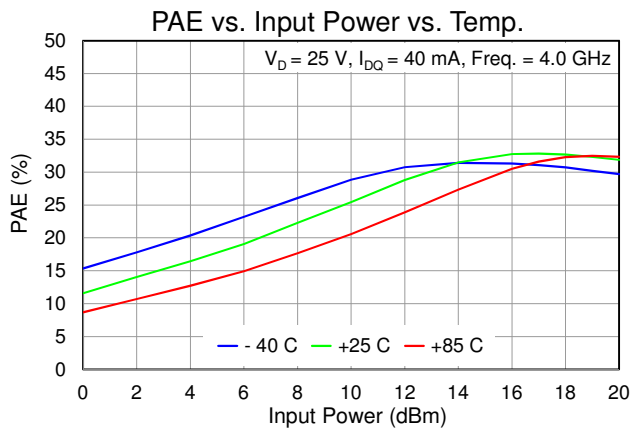
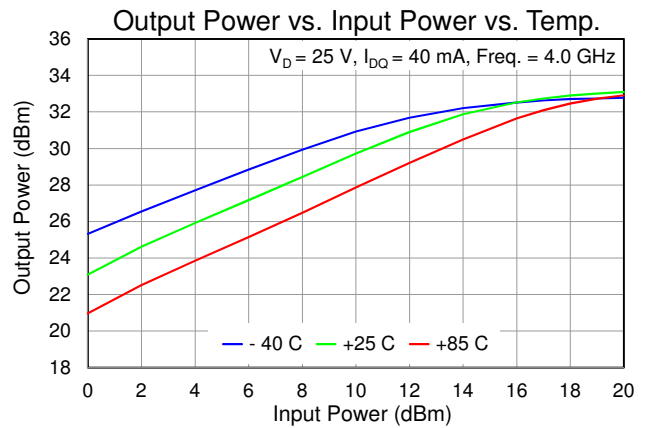
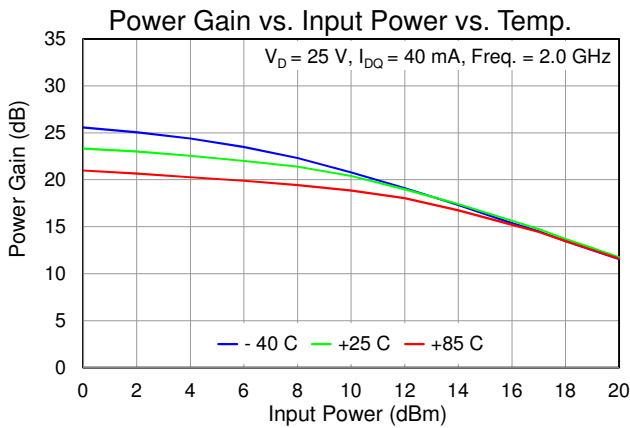
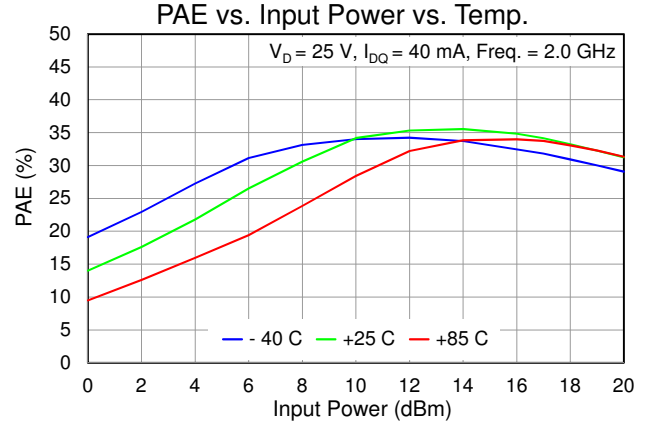
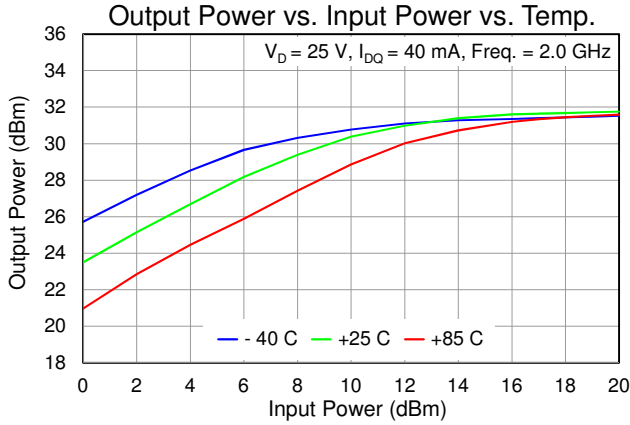

Typical Performance – Large Signal, Harmonics

Test conditions unless otherwise noted: 25 °C, $V_D = 25\text{ V}$, $I_{DQ} = 40\text{ mA}$, $V_G = -2.5\text{ V typ.}$, die mounted to EVB

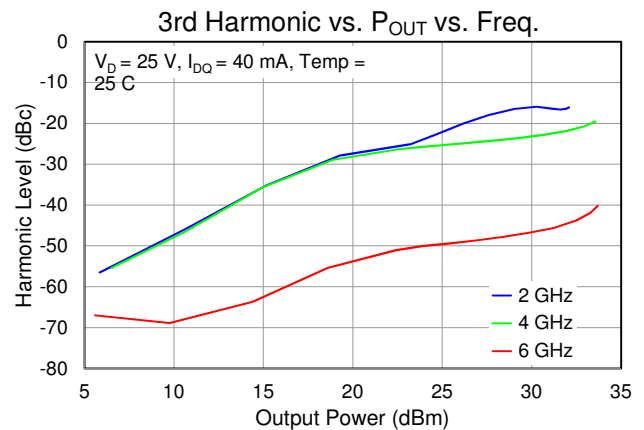
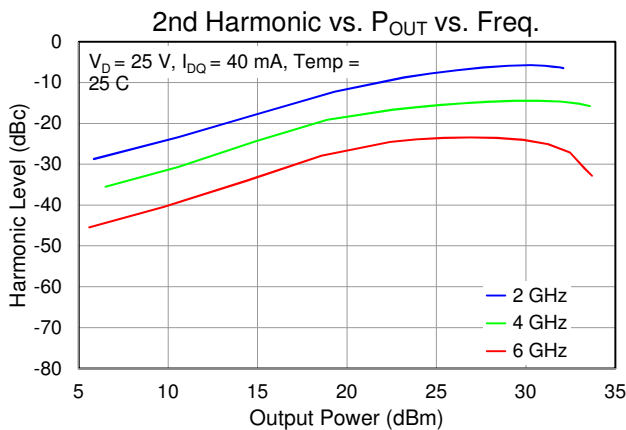
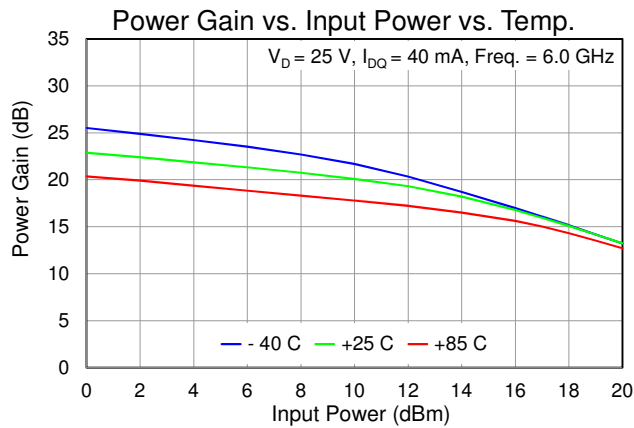
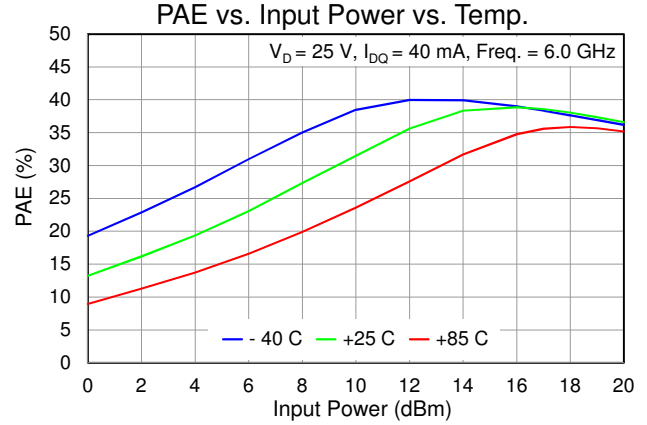
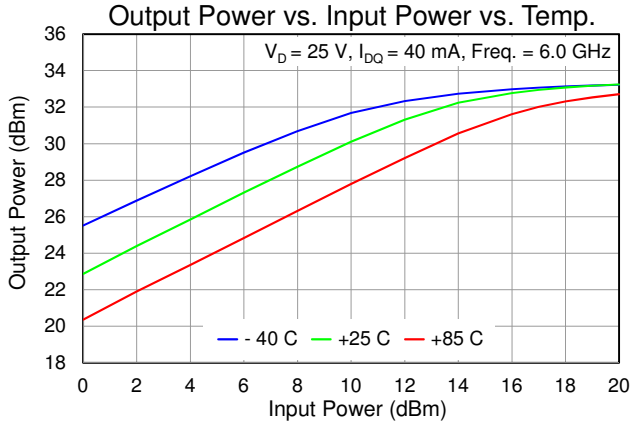

Typical Performance – Harmonics, Linearity

Test conditions unless otherwise noted: 25 °C, $V_D = 25$ V, $I_{DQ} = 40$ mA, $V_G = -2.5$ V typ., die mounted to EVB

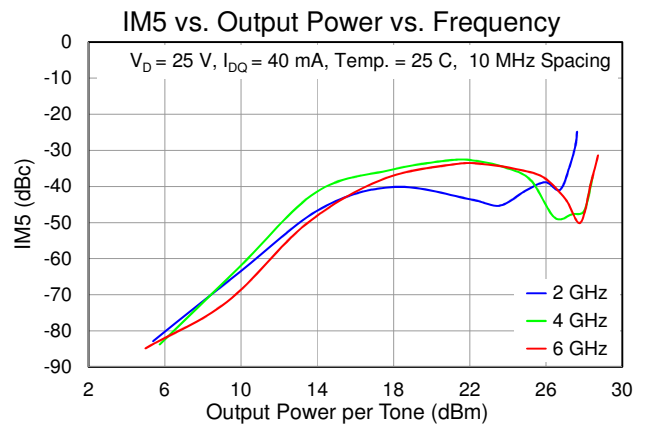
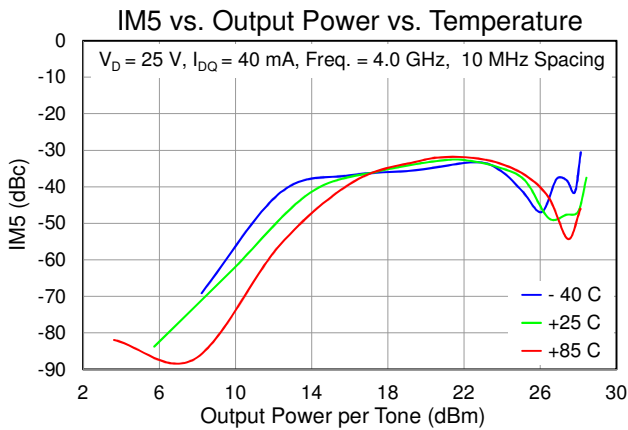
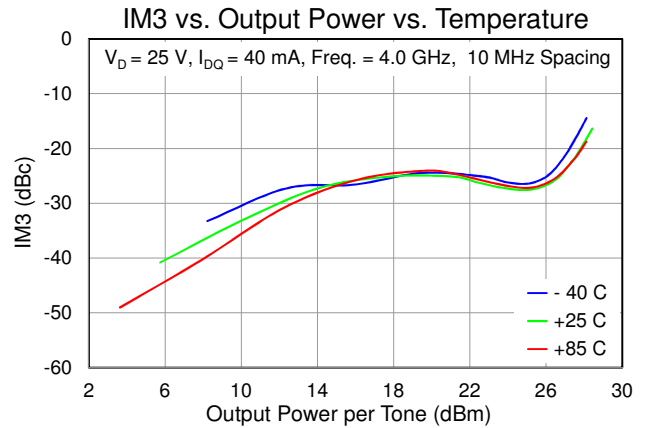
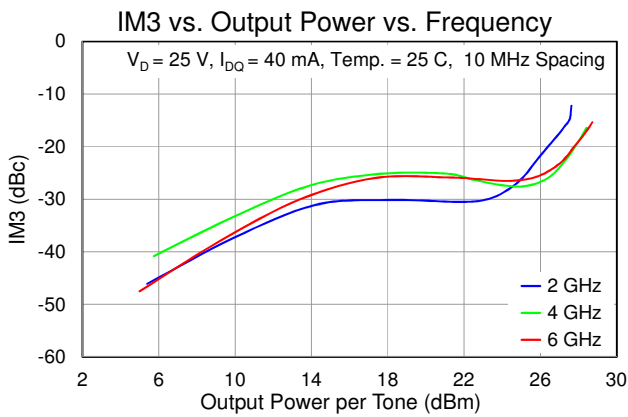
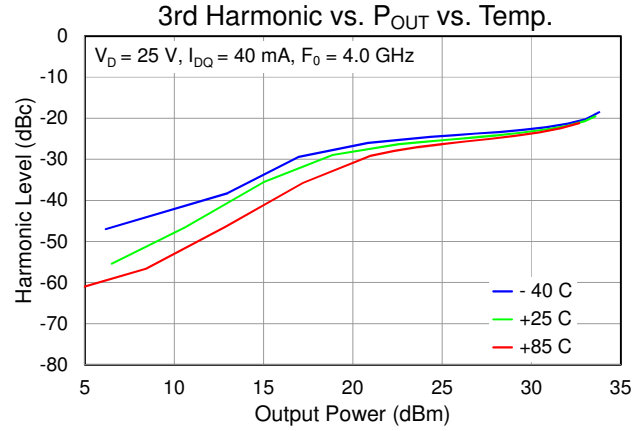
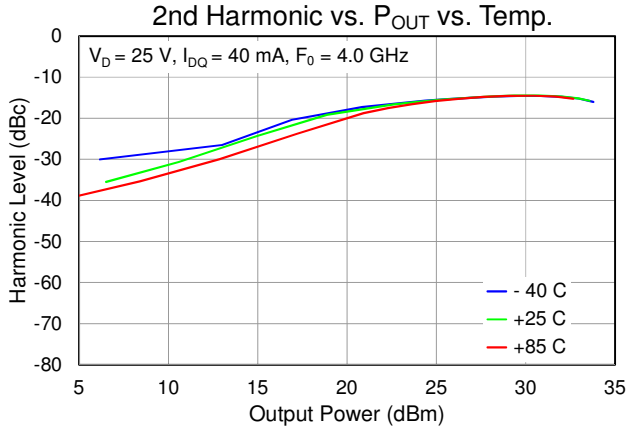

Application Circuit

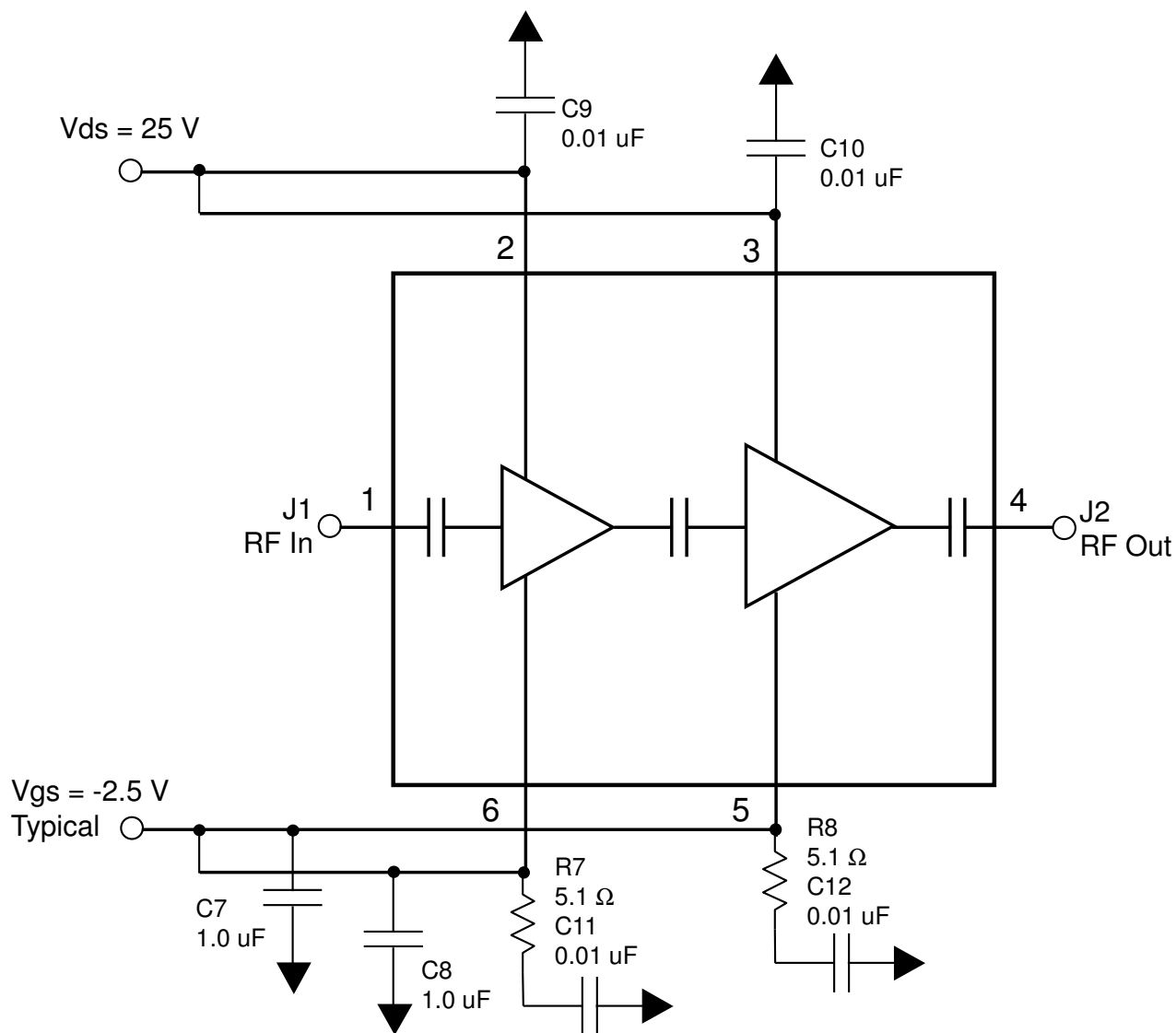

Bias-up Procedure

1. Set I_D limit to 400 mA, I_G limit to 4.5 mA
2. Set V_G to -5.0V
3. Set V_D +25V
4. Adjust V_G more positive until $I_{DQ} = 40$ mA.
5. Apply RF signal

Bias-down Procedure

1. Turn off RF signal
2. Set V_G to -5.0V. Ensure $I_{DQ} \sim 0$ mA
3. Set V_D to 0V
4. Turn off V_D supply
5. Turn off V_G supply

Evaluation Board

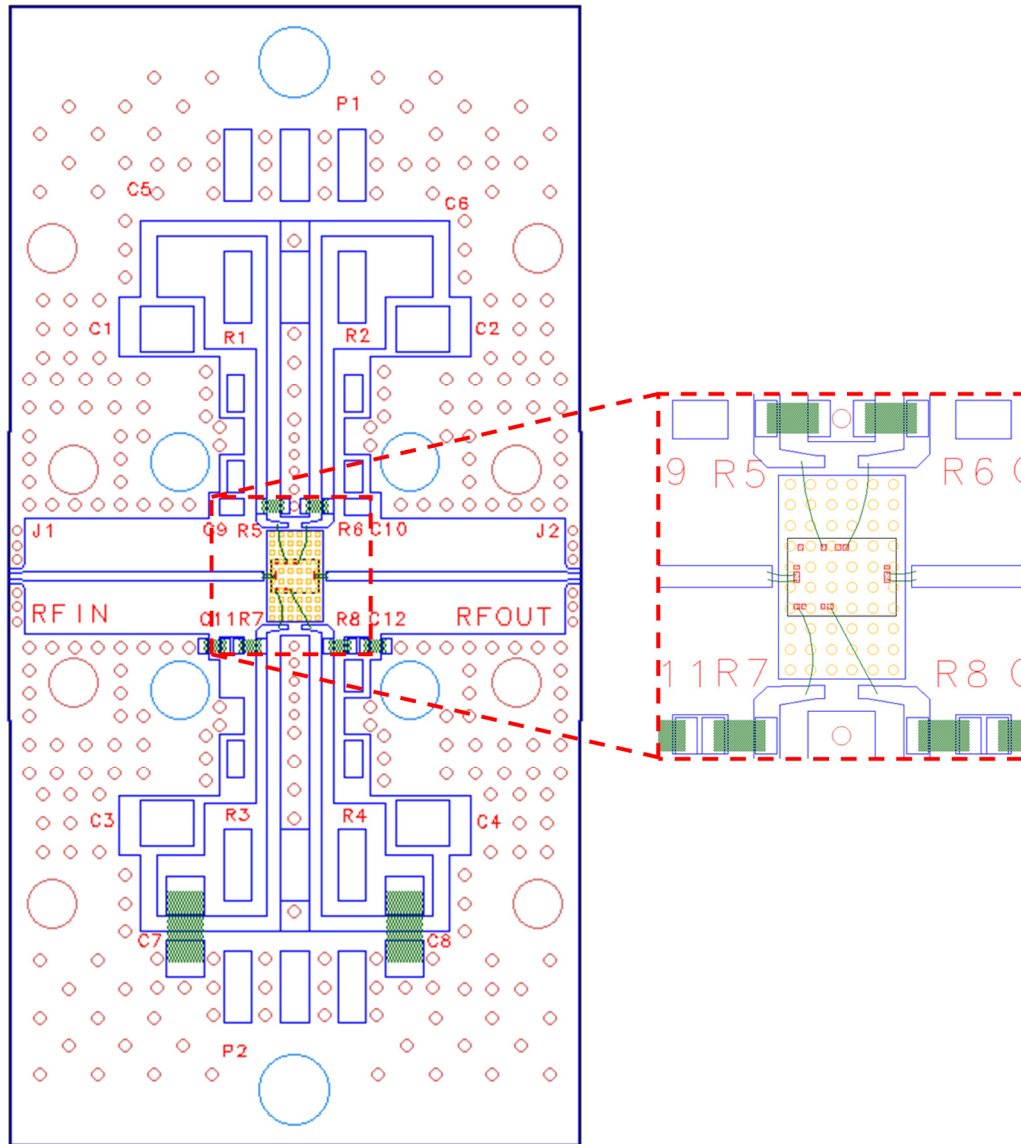

Bill of Materials

Ref. Designation	Value	Description	Manufacturer	Part Number
R7 – R8	5.1 Ohm	Res, 0402, 5% ROHS	Various	
C7 – C8	1.0 uF	Cap, 1206, 16V, 20%, X5R	Various	
C9 – C12	0.01 uF	Cap, 0402, 50V, 10%, X7R	Various	

RF Layer is 0.008" thick Rogers Corp. RO4003C, $\epsilon_r = 3.38$. Metal layers are 0.5 oz. copper. The microstrip line at the connector interface is optimized for the Southwest Microwave end launch connector 1092-01A-5. Die attach is accomplished with conductive epoxy. The PCB land pattern has been developed to accommodate bond wire and die tolerances.

Mechanical Drawing & Bond Pad Description

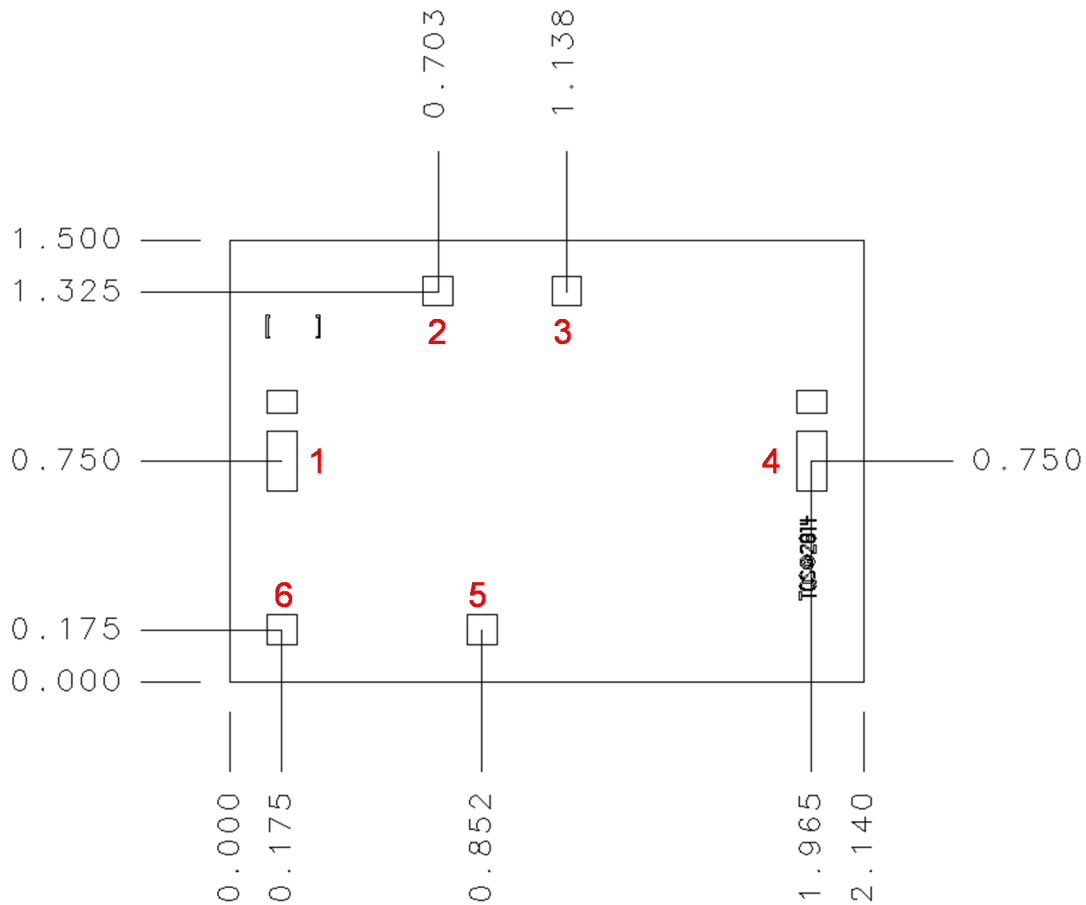

Unit: millimeters
 Thickness: 0.10
 Die x, y size tolerance: +/- 0.050
 Chip edge to bond pad dimensions are shown to center of pad
 Ground is backside of die

Bond Pad	Symbol	Description	Pad Size (um x um)
1	RF In	RF Input; matched to 50 ohms; AC coupled.	100 x 200
2	V _{D1}	Drain voltage, first stage.	100 x 100
3	V _{D2}	Drain voltage, second stage.	100 x 100
4	RF Out	RF Output; matched to 50 ohms; AC coupled.	100 x 200
5	V _{G2}	Gate voltage, second stage.	100 x 100
6	V _{G1}	Gate voltage, first stage.	100 x 100

Assembly Notes

Component placement and adhesive attachment assembly notes:

- Vacuum pencils and/or vacuum collets are the preferred method of pick up.
- Air bridges must be avoided during placement.
- The force impact is critical during auto placement.
- Organic attachment (i.e. epoxy) can be used in low-power applications.
- Curing should be done in a convection oven; proper exhaust is a safety concern.

Reflow process assembly notes:

- Use AuSn (80/20) solder and limit exposure to temperatures above 300°C to 3-4 minutes, maximum.
- An alloy station or conveyor furnace with reducing atmosphere should be used.
- Do not use any kind of flux.
- Coefficient of thermal expansion matching is critical for long-term reliability.
- Devices must be stored in a dry nitrogen atmosphere.

Interconnect process assembly notes:

- Thermosonic ball bonding is the preferred interconnect technique.
- Force, time, and ultrasonics are critical parameters.
- Aluminum wire should not be used.
- Devices with small pad sizes should be bonded with 0.0007-inch wire.

Product Compliance Information

ESD Sensitivity Ratings



Caution! ESD-Sensitive Device

ESD Rating: TBD
Value: TBD
Test: Human Body Model (HBM)
Standard: JEDEC Standard JESD22-A114

ECCN

US Department of Commerce: EAR99

Solderability

Use only AuSn (80/20) solder and limit exposure to temperatures above 300 °C to 3-4 minutes, maximum.

RoHS-Compliance

This part is compliant with EU 2002/95/EC RoHS directive (Restrictions on the Use of Certain Hazardous Substances in Electrical and Electronic Equipment).

This product also has the following attributes:

- Lead Free
- Halogen Free (Chlorine, Bromine)
- Antimony Free
- TBBP-A (C₁₅H₁₂Br₄O₂) Free
- PFOS Free
- SVHC Free

Contact Information

For the latest specifications, additional product information, worldwide sales and distribution locations, and information about TriQuint:

Web: www.triquint.com

Email: info-sales@triquint.com

Tel: +1.972.994.8465

Fax: +1.972.994.8504

For technical questions and application information:

Email: info-products@triquint.com

Important Notice

The information contained herein is believed to be reliable. TriQuint makes no warranties regarding the information contained herein. TriQuint assumes no responsibility or liability whatsoever for any of the information contained herein. TriQuint assumes no responsibility or liability whatsoever for the use of the information contained herein. The information contained herein is provided "AS IS, WHERE IS" and with all faults, and the entire risk associated with such information is entirely with the user. All information contained herein is subject to change without notice. Customers should obtain and verify the latest relevant information before placing orders for TriQuint products. The information contained herein or any use of such information does not grant, explicitly or implicitly, to any party any patent rights, licenses, or any other intellectual property rights, whether with regard to such information itself or anything described by such information.

TriQuint products are not warranted or authorized for use as critical components in medical, life-saving, or life-sustaining applications, or other applications where a failure would reasonably be expected to cause severe personal injury or death.