

# TGA2704-SM

## 8W 9-11 GHz Power Amplifier



### Applications

- Marine and Air Radar, Traffic Control
- Weather Monitoring
- Port Security
- Point-to-Point Radio
- Communications

### Product Features

- Frequency Range: 9 - 11 GHz
- Saturated Output Power: 39 dBm
- Small Signal Gain: 21 dB
- Bias:  $V_d = 9\text{ V}$ ,  $I_{dq} = 1.05\text{ A}$ ,  $V_g = -0.74\text{ V}$  typical

### General Description

The TriQuint TGA2704-SM provides 21 dB of small signal gain and 8W of output power across 9-11 GHz. TGA2704-SM is designed using TriQuint's proven standard 0.25 $\mu\text{m}$  gate pHEMT 3MI production process.

The TGA2704-SM features a ceramic QFN designed for surface mount to a printed circuit board.

Fully matched to 50 ohms and with integrated DC blocking capacitors on both I/O ports, the TGA2704-SM is ideally suited to support both commercial and defense related applications

Lead-free and RoHS compliant.

Evaluation Boards are available upon request.

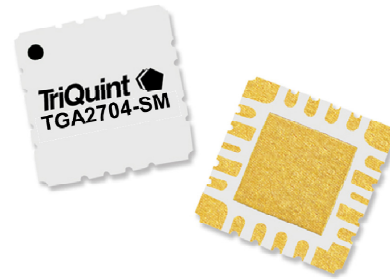

QFN 7x7mm 22L

### Functional Block Diagram

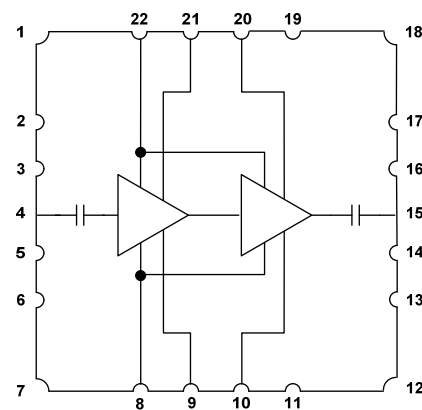

### Pin Configuration

Pin #	Symbol
1,2,3,5,6,7,11,12,13,14,16,17,18,19	Gnd
4	RF In
8	Vg
9	Vd1
10	Vd2
15	RF Out
20	Vd2
21	Vd1
22	Vg

### Ordering Information

Part No.	ECCN	Description
TGA2704-SM	3A001.b.2.b	X-band Power Amplifier

# TGA2704-SM

## 8W 9-11 GHz Power Amplifier



### Specifications

#### Absolute Maximum Ratings

Parameter	Rating
Drain Voltage, Vd	10 V
Gate Voltage, Vg	-1.2 to 0.5 V
Drain Current, Id	3.85 A
Gate Current range, Ig	-14 to 126 mA
RF Input Power, CW, 50Ω, T = 25°C	23 dBm
Channel Temperature, Tch	200 °C
Mounting Temperature (30 Seconds)	260 °C
Storage Temperature	-40 to 150 °C

Operation of this device outside the parameter ranges given above may cause permanent damage. These are stress ratings only, and functional operation of the device at these conditions is not implied.

#### Recommended Operating Conditions

Parameter	Min	Typ	Max	Units
Vd		9		V
Idq (no RF drive)		1.05		A
Id_drive (under RF drive)		2.06		A
Vg		-0.74		V

Electrical specifications are measured at specified test conditions. Specifications are not guaranteed over all recommended operating conditions

### Electrical Specifications

Test conditions unless otherwise noted: 25°C, Vd = 9 V, Idq = 1.05 A, Vg = -0.74 V typical, CW

Parameter	Min	Typ	Max	Units
Operational Frequency Range	9		11	GHz
Small Signal Gain		21		dB
Small Signal Gain Temperature Coefficient		-0.046		dB/°C
Output Power @ Saturation		39		dBm
Power-Added Efficiency @ Saturation		42		%
Output Power @ 1 dB compression		38.5		dBm
Output Power Temperature Coefficient		-0.011		dB/°C

### Specifications (cont'd)

#### Thermal and Reliability Information

Parameter	Condition	Rating
Channel Temperature (Tch), Median Lifetime (Tm), Thermal Resistance*	Tbase = 85 °C, Vd = 7V, Idq = 1.40 A, Pdiss 9.8 W, no RF input power, CW	Tch 161°C Tm = 4.1E+5 Hours θJC = 7.8 °C/W
Channel Temperature (Tch), Median Lifetime (Tm), Thermal Resistance*	Tbase = 85 °C, Vd = 7V, Id = 1.93 A, Pdiss = 8.1 W, Pout = 37.3 dBm, CW	Tch = 137°C Tm = 3.1E+6 Hours θJC = 6.4°C/W
Channel Temperature (Tch), Median Lifetime (Tm), Thermal Resistance*	Tbase = 85 °C, Vd = 9V, Idq = 1.05 A, Pdiss = 9.5 W, no RF input power, CW	Tch = 156 °C Tm = 6.1E+5 Hours θJC = 7.5°C/W
Channel Temperature (Tch), Median Lifetime (Tm), Thermal Resistance*	Tbase = 85 °C, Vd = 9V, Id = 2.11 A, Pdiss = 11.2 W, Pout = 38.9 dBm, CW	Tch = 156°C Tm = 6.1E+5 Hours θJC = 6.3°C/W

\* Thermal Resistance, θJC, measured to center bottom of package

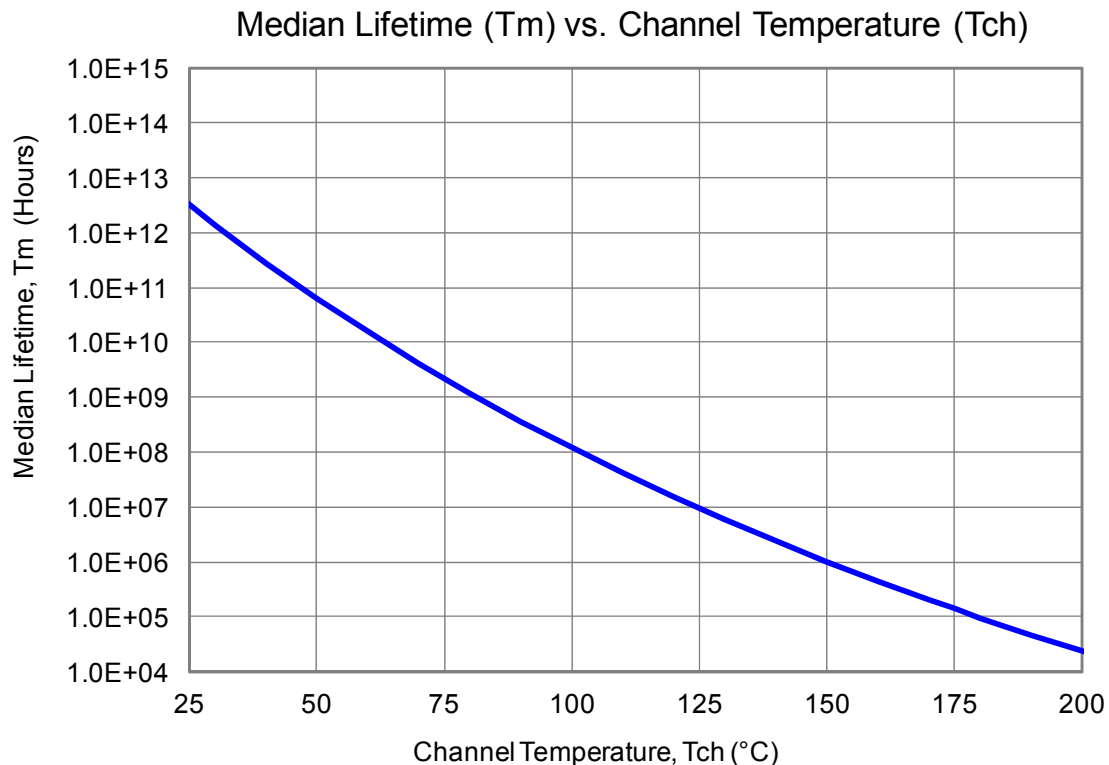

# TGA2704-SM

## 8W 9-11 GHz Power Amplifier



### Typical Performance

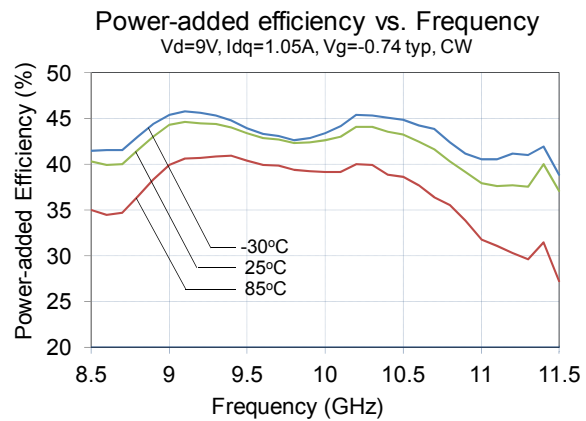
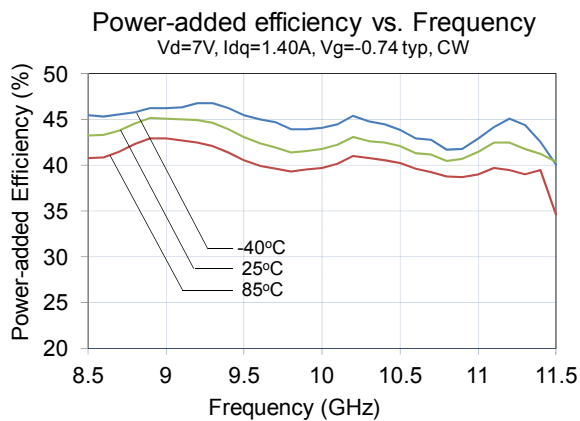
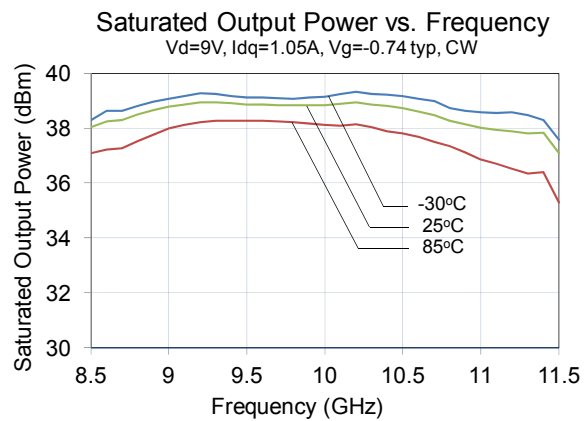
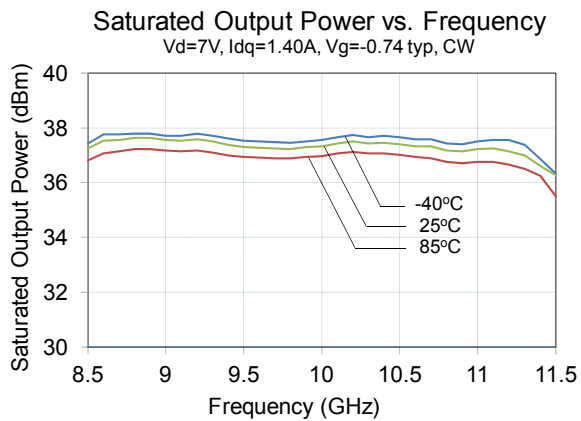
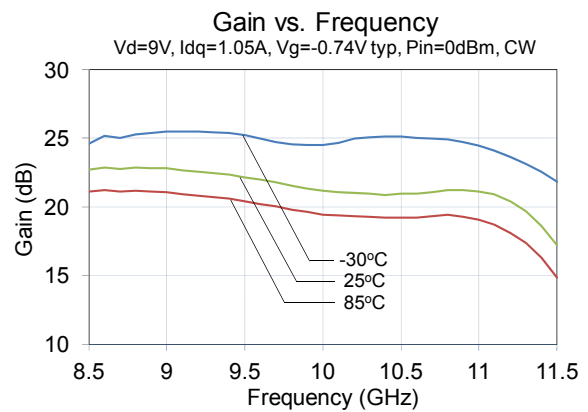
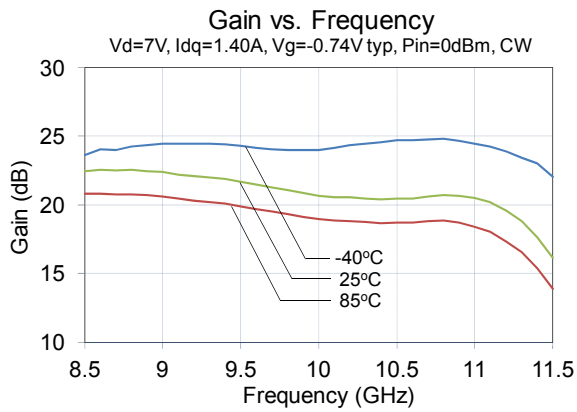

# TGA2704-SM

## 8W 9-11 GHz Power Amplifier



### Typical Performance

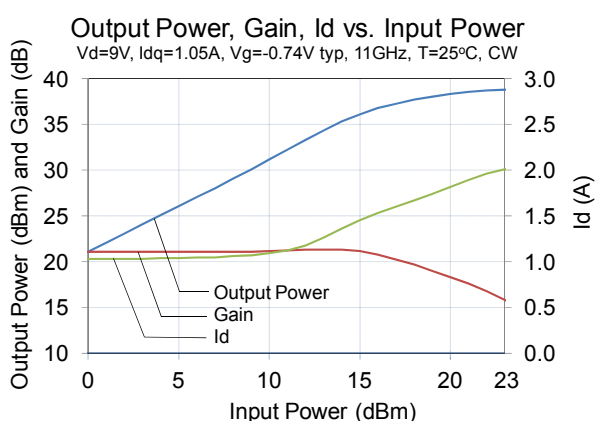
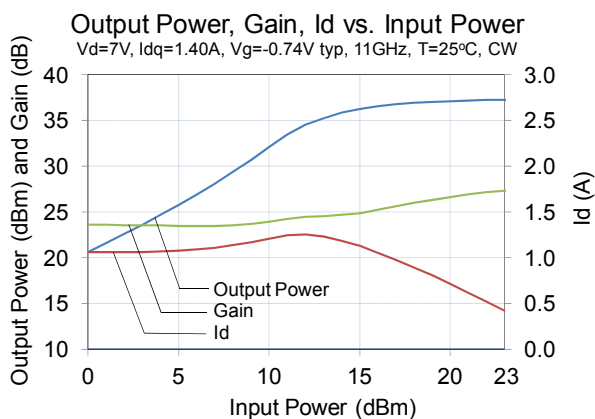
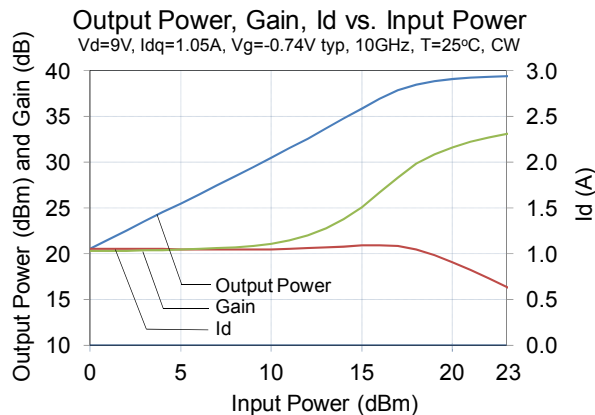
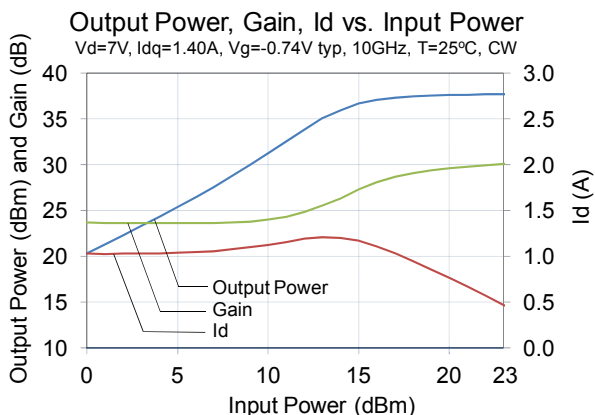
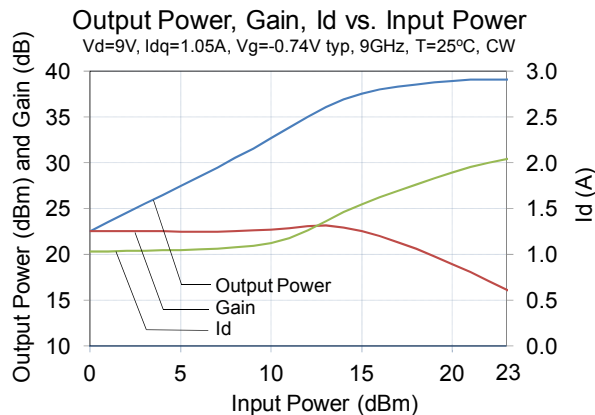
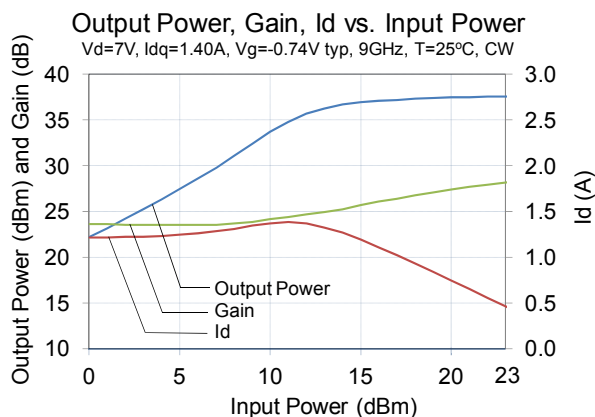

# TGA2704-SM

## 8W 9-11 GHz Power Amplifier

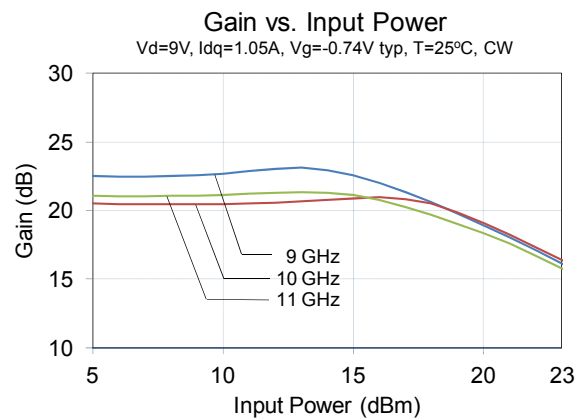
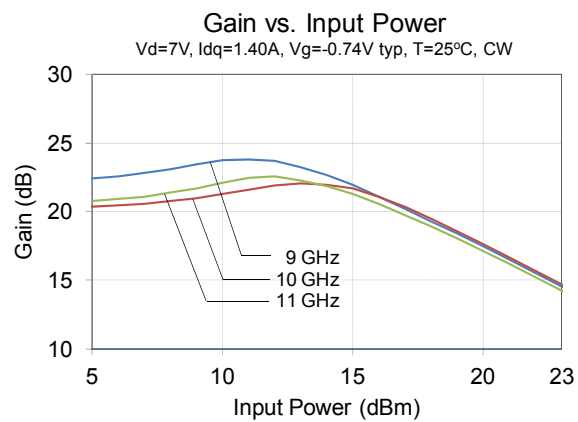
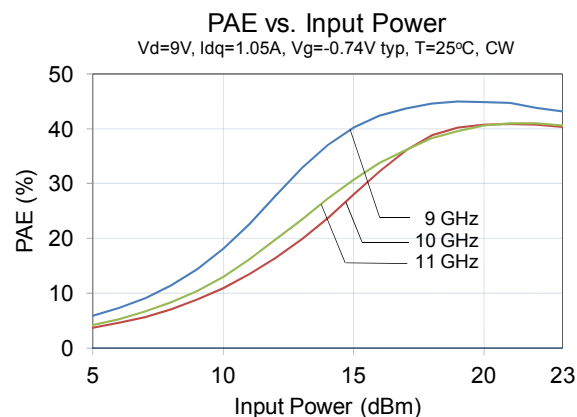
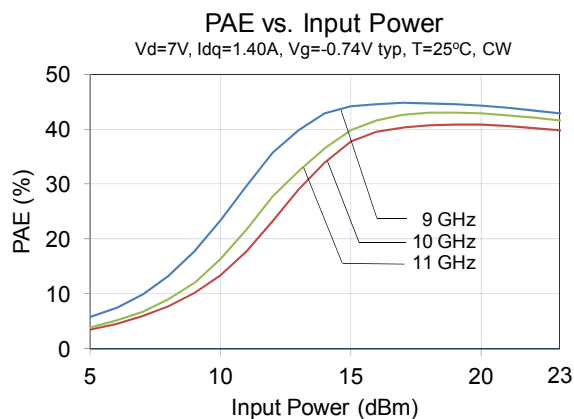
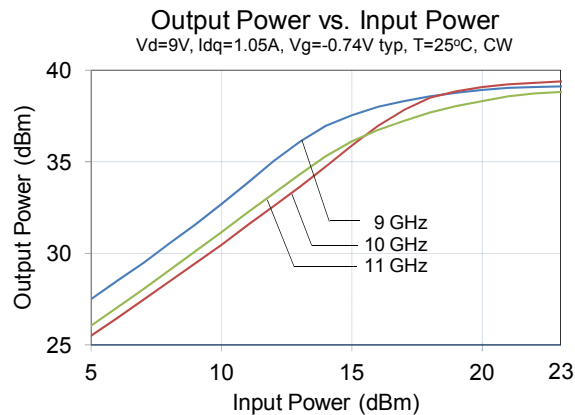
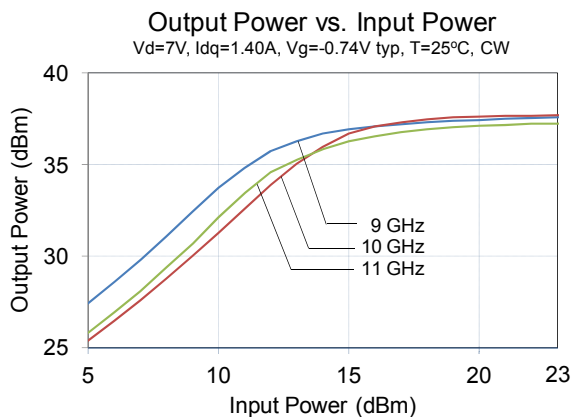

# TGA2704-SM

## 8W 9-11 GHz Power Amplifier



### Typical Performance

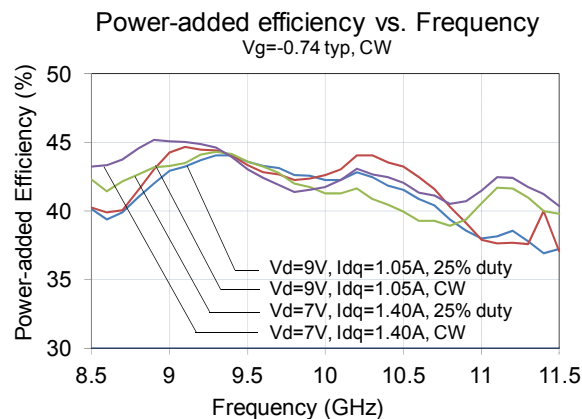
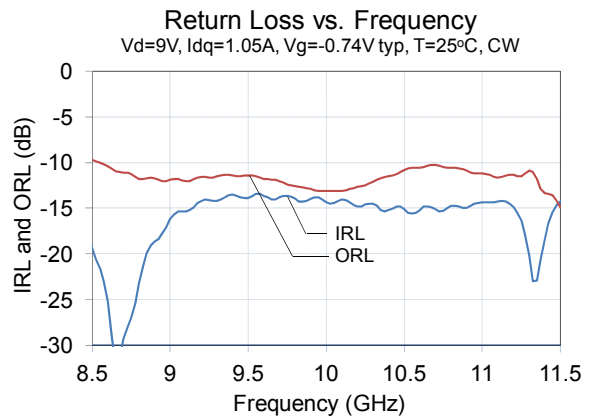
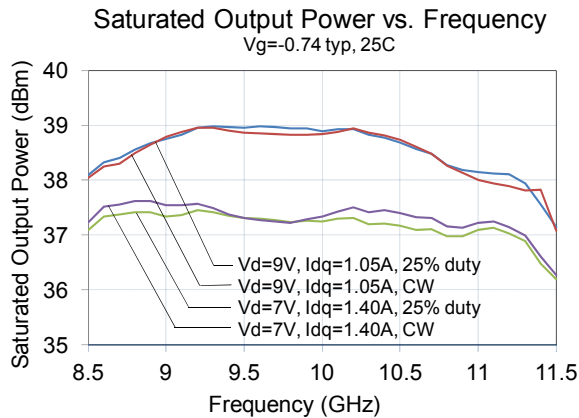
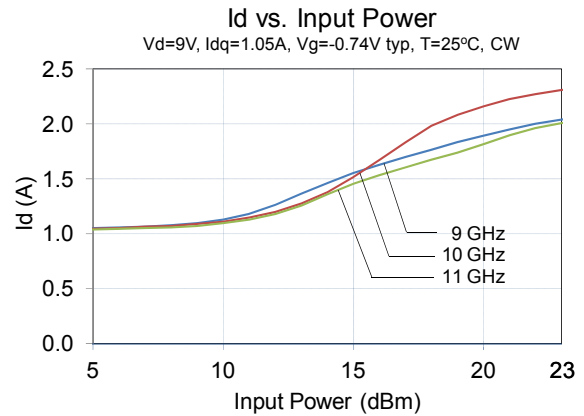
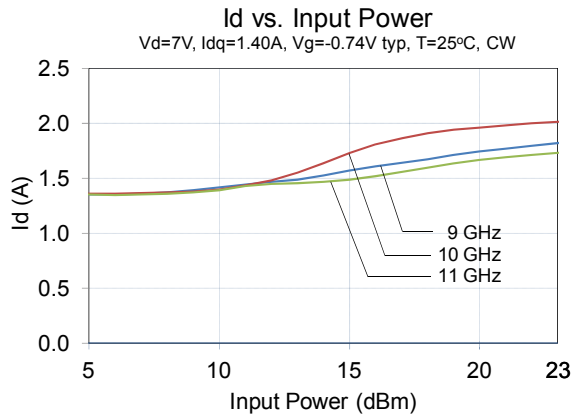

# TGA2704-SM

## 8W 9-11 GHz Power Amplifier

### Application Circuit

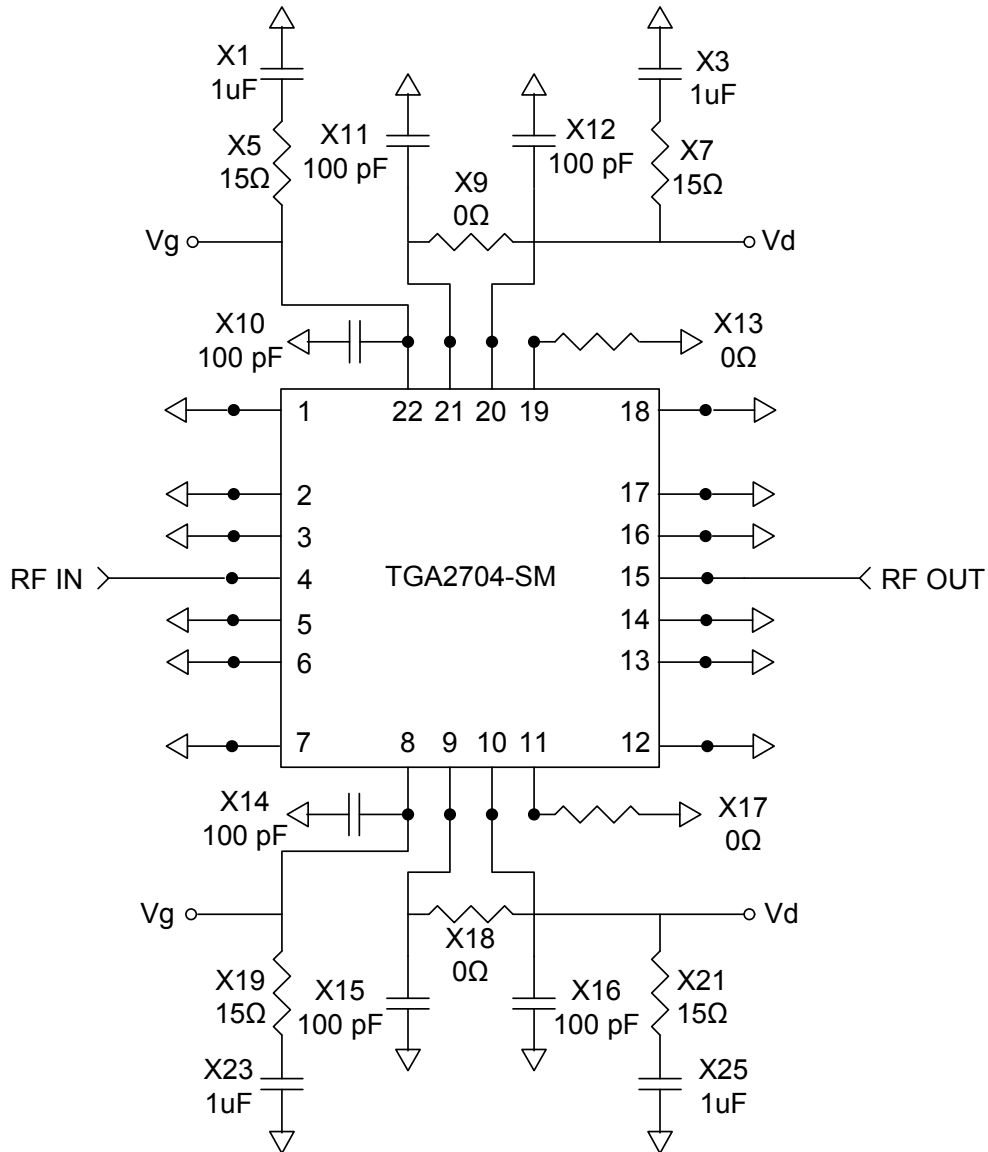

#### Bias-up Procedure

- Turn Vg to -1.2 V
- Turn Vd to 9 V
- Adjust Vg more positive until Idq is 1.05 A. This will be Vg ~ -0.74 V typical
- Apply RF signal

#### Bias-down Procedure

- Turn off RF signal
- Reduce Vg to -1.2 V. Ensure Id ~ 0 mA
- Turn Vd to 0 V
- Turn Vg to 0 V



# TGA2704-SM

## 8W 9-11 GHz Power Amplifier

### Pin Description



Pin #	Symbol	Description
1,2,3,5,6,7,11,12,13,14,16,17,18,19	Gnd	Connect to Ground
4	RF In	Input, matched to 50Ω
8	Vg	Gate voltage. Bias network is required
9	Vd1	Drain 1 voltage. Bias network is required
10	Vd2	Drain 2 voltage. Bias network is required
15	RF Out	Output, matched to 50Ω
20	Vd2	Drain 2 voltage. Bias network is required
21	Vd1	Drain 1 voltage. Bias network is required
22	Vg	Gate voltage. Bias network is required

Note: See Application Circuit on page 8 as an example

# TGA2704-SM

## 8W 9-11 GHz Power Amplifier

### Evaluation Board Layout

#### PC Board Layout

Board material is RO4003 0.008" thickness with ½ oz copper cladding.

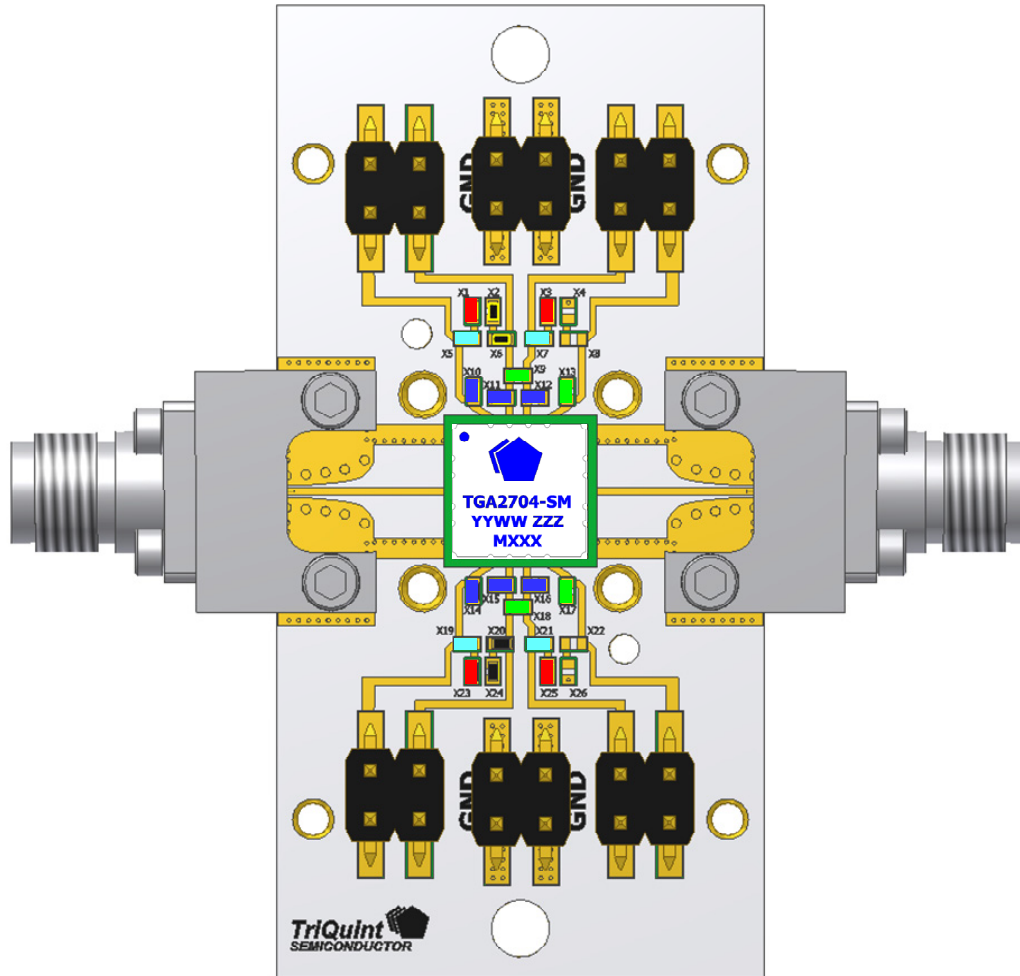

#### Bill of Material

Ref Des	Value	Description	Manufacturer	Part Number
X1,X3,X23, X25	1 uF	Cap, 0402	TDK	C1005XR1C105M
X10,X11, X12,X14, X15,X16	100 pF	Cap, 0402	AVX	04025C101KAT2A
X5,X7,X19, X21	15Ω	Resistor, 0402	Panasonic	ERJ-2GEJ150X
X9,X13,X17, X18	0Ω	Resistor, 0402	Panasonic	ERJ-2GE0R00X

# TGA2704-SM

## 8W 9-11 GHz Power Amplifier

### Mechanical Information

#### Package Information and Dimensions

All dimensions in inches and are +/- 0.006in unless otherwise noted.

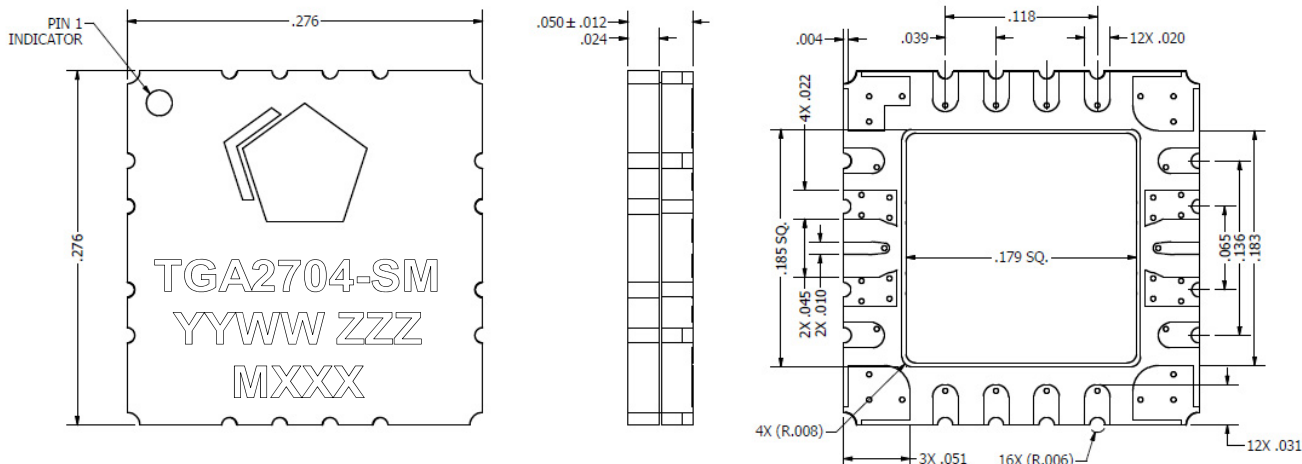

Part marking:

<b>YY</b>	assembly lot start year
<b>WW</b>	assembly lot start week
<b>ZZZ</b>	part serial number
<b>MXXX</b>	batch ID

#### PCB Mounting Pattern

All dimensions in inches

Notes:

- The pad pattern shown has been developed and tested for optimized assembly at TriQuint Semiconductor. The PCB land pattern has been developed to accommodate lead and package tolerances. Since surface mount processes vary from company to company, careful process development is recommended.
- Ground / thermal vias are critical for the proper performance of this device. Vias should use a 0.008in diameter drill, and they are solid filled, copper plated shut or silver filled paste with over plating.

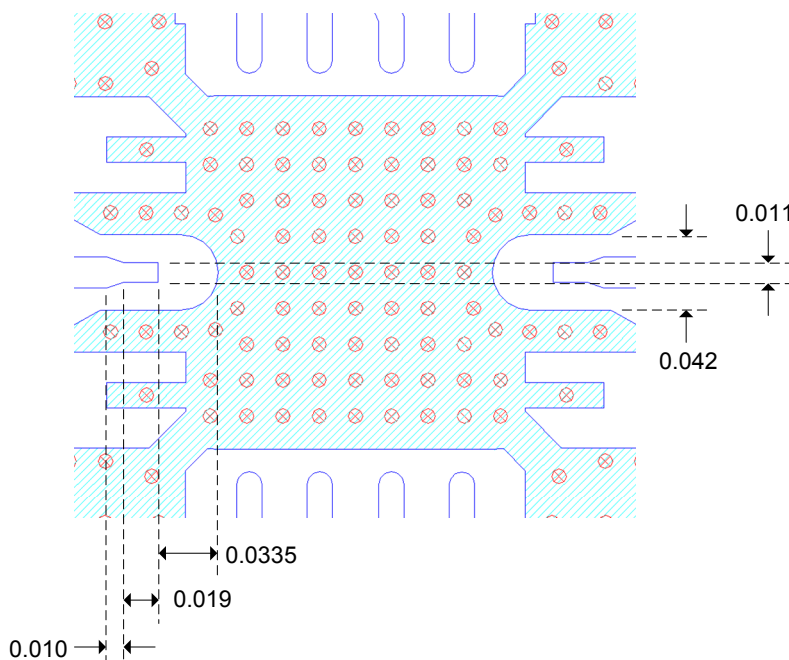

### Product Compliance Information

#### ESD Information



#### Caution! ESD-Sensitive Device

ESD rating: TBD  
 Value: Passes < TBD V min.  
 Test: Human Body Model (HBM)  
 Standard: JEDEC Standard JESD22-A114

#### Solderability

This part is compliant with EU 2002/95/EC RoHS directive (Restrictions on the Use of Certain Hazardous Substances in Electrical and Electronic Equipment).

This product also has the following attributes:

- Lead Free
- Halogen Free (Chlorine, Bromine)
- Antimony Free
- TBBP-A (C<sub>15</sub>H<sub>12</sub>Br<sub>4</sub>O<sub>2</sub>) Free
- PFOS Free

#### ECCN

US Department of Commerce: 3A001.b.2.b

### Recommended Soldering Temperature Profile

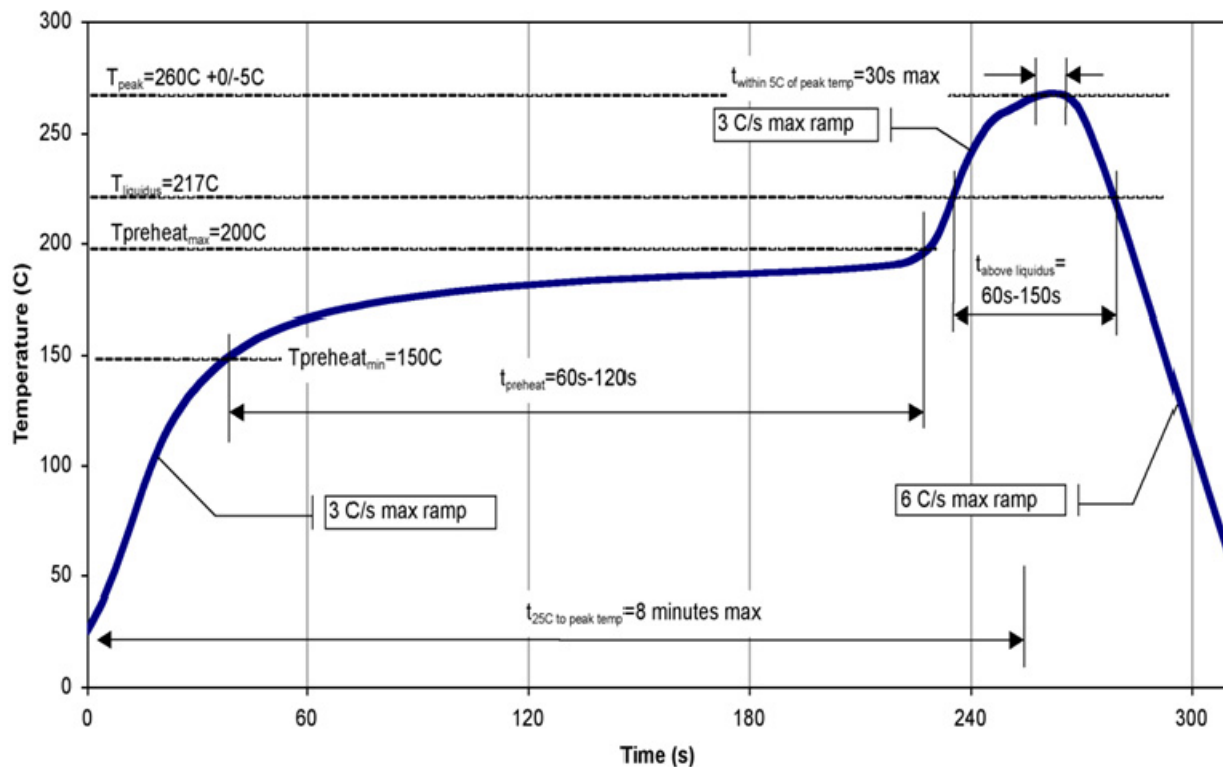

# TGA2704-SM

## 8W 9-11 GHz Power Amplifier

---



### Contact Information

For the latest specifications, additional product information, worldwide sales and distribution locations, and information about TriQuint:

Web: [www.triquint.com](http://www.triquint.com)  
Email: [info-products@tqs.com](mailto:info-products@tqs.com)

Tel: +1.972.994.8465  
Fax: +1.972.994.8504

### Important Notice

The information contained herein is believed to be reliable. TriQuint makes no warranties regarding the information contained herein. TriQuint assumes no responsibility or liability whatsoever for any of the information contained herein. TriQuint assumes no responsibility or liability whatsoever for the use of the information contained herein. The information contained herein is provided "AS IS, WHERE IS" and with all faults, and the entire risk associated with such information is entirely with the user. All information contained herein is subject to change without notice. Customers should obtain and verify the latest relevant information before placing orders for TriQuint products. The information contained herein or any use of such information does not grant, explicitly or implicitly, to any party any patent rights, licenses, or any other intellectual property rights, whether with regard to such information itself or anything described by such information.

TriQuint products are not warranted or authorized for use as critical components in medical, life-saving, or life-sustaining applications, or other applications where a failure would reasonably be expected to cause severe personal injury or death.