

CATV Linear Amplifier

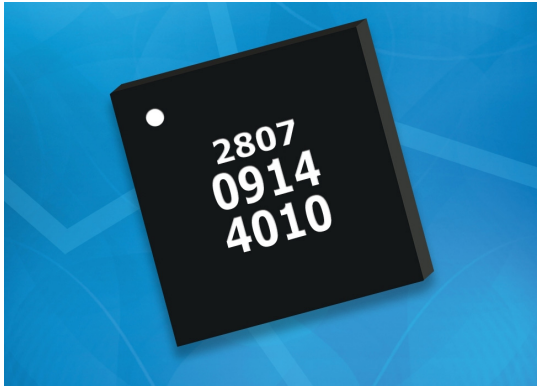

Measured Performance

Small Signal Gain (75 Ω) including Balun Loss,
Vdd = 6 V, Idd = 318 mA

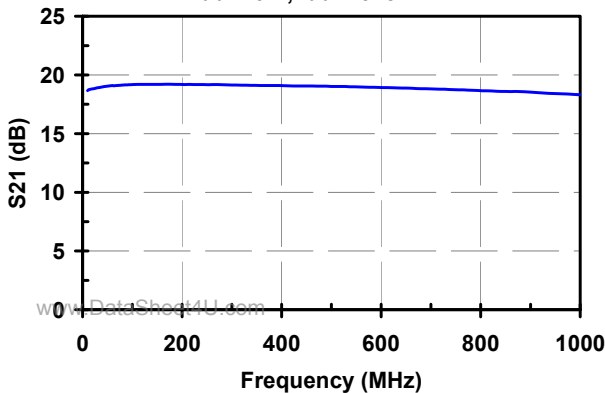

ACPR (75 Ω), single 256-QAM channel,
Vdd = 6 V, Pout = 62 dBmV

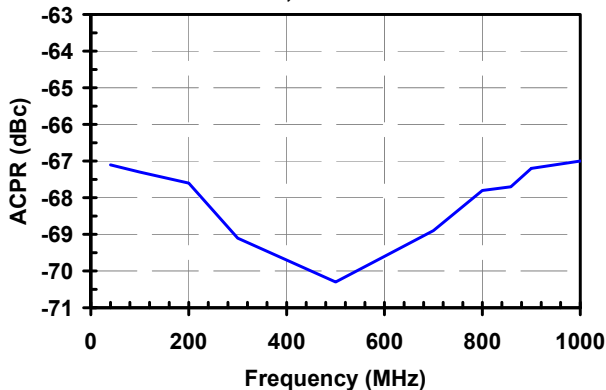

Key Features

- Frequency Range: 40MHz - 1.00 GHz
- DOCSIS 3.0 Compliant
- ACPR: -69 dBc at 61 dBmV Pout
- P_{diss}: 1.9W
- Gain: 18.5 dB Typical
- P_{sat}: 28 dBm
- NF: 2.5 dB
- Output Return Loss: 20 dB
- Bias: V_{dd} = +6 V, I_{dd} = 318 mA, Single Supply
- Package Dimensions: 5 x 5 x 0.85 mm

Primary Applications

- CATV EDGE QAM Cards
- CMTS Equipment

Product Description

The TriQuint TGA2807-SM is an ultra-linear packaged Gain Block which operates from 40MHz to 1GHz.

The TGA2807-SM provides flat gain along with ultra-low distortion. It also provides high output power with low DC power consumption.

This amplifier is ideally suited for use in CATV headend systems or other applications requiring low noise and low distortion.

Demonstration Boards are available.

Lead-free and RoHS compliant.

Datasheet subject to change without notice.

Table I
Absolute Maximum Ratings 1/

Symbol	Parameter	Value	Notes
Vdd-Vg	Drain to Gate Voltage	11 V	
Vdd	Drain Voltage	10 V	<u>2/</u>
Vg1	Gate #1 Voltage Range	-1 to 3 V	
Vg2	Gate #2 Voltage Range	0 to 5 V	
Id	Drain Current	410 mA	<u>2/</u>
Pin	Input Continuous Wave Power	73.75 dBmV	<u>2/</u>

1/ These ratings represent the maximum operable values for this device. Stresses beyond those listed under “Absolute Maximum Ratings” may cause permanent damage to the device and / or affect device lifetime. These are stress ratings only, and functional operation of the device at these conditions is not implied.

2/ Combinations of supply voltage, supply current, input power, and output power shall not exceed the maximum power dissipation listed in Table IV.

Table II
Recommended Operating Conditions

Symbol	Parameter <u>1/</u>	Value
Vdd	Drain Voltage	6 V
Idd	Drain Current	318 mA
Vg1	Gate #1 Voltage	0.95 V <u>2/</u>
Vg2	Gate #2 Voltage	2.65 V <u>2/</u>

1/ See assembly diagram for bias instructions.

2/ The amplifier is self-biased. Typical values are listed. External gate bias is optional.

Table III RF Characterization Table

$V_{dd} = 6\text{ V}$, $T_A = 25^\circ\text{C}$ 1/

Symbol	Parameter	Min	Typ	Max	Units	Note
BW	Bandwidth	40		1000	MHz	
S21	Power Gain		18.5		dB	
GF	Gain Flatness		± 0.5		dB	<u>2/</u>
NF	Noise Figure		2.5		dB	<u>3/</u>
IP3	Two-Tone Third-Order Intercept (150MHz)		43		dBm	<u>4/</u>
IP3	Two-Tone Third-Order Intercept (750MHz)		40		dBm	<u>5/</u>
ACPR	ACPR		-69		dBc	<u>6/</u>
	Harmonics (2 nd , 3 rd , 4 th) (40 to 500MHz)		-69		dBc	<u>7/</u>
IRL	Input Return Loss		15		dB	
ORL	Output Return Loss		20		dB	
I _{dd}	Drain current		318	410	mA	
P _{sat}	Saturated Output Power (750MHz)		28		dBm	

1/ Using application circuit on pg. 14

2/ Across the operating frequency band

3/ At 500MHz carrier frequency

4/ Measured at 15 dBm output power per tone, $V_{dd} = 6\text{ V}$

5/ Measured at 14 dBm output power per tone, $V_{dd} = 6\text{ V}$

6/ Using single channel 256-QAM signal at 858MHz and 61 dBmV output power, measured in the band 750kHz from channel block edge to 6MHz from channel block edge.

7/ Using quad 256-QAM channels at 54dBmV output power per channel

Table IV
Power Dissipation and Thermal Properties

Parameter	Test Conditions	Value	Notes
Maximum Power Dissipation	Tbaseplate = 85°C	Pd = 4.1 W Tchannel = 153 °C Tm = 7.9E+5 Hrs	<u>1/ 2/</u>
Thermal Resistance, θ_{jc}	Vdd = 6 V Idd = 318 mA Pd = 1.92 W	θ_{jc} = 16.7 °C/W Tchannel = 117 °C Tm = 2.1E+7 Hrs	
Mounting Temperature		Refer to Solder Reflow Profiles (pg18)	
Storage Temperature		-65 to 150 °C	

1/ For a median life of 1E+6 hours, Power Dissipation is limited to

$$Pd(max) = (150\text{ °C} - Tbase\text{ °C})/\theta_{jc}.$$

2/ Channel operating temperature will directly affect the device lifetime. For maximum life, it is recommended that channel temperatures be maintained at the lowest possible levels.

Median Lifetime (Tm) vs. Channel Temperature

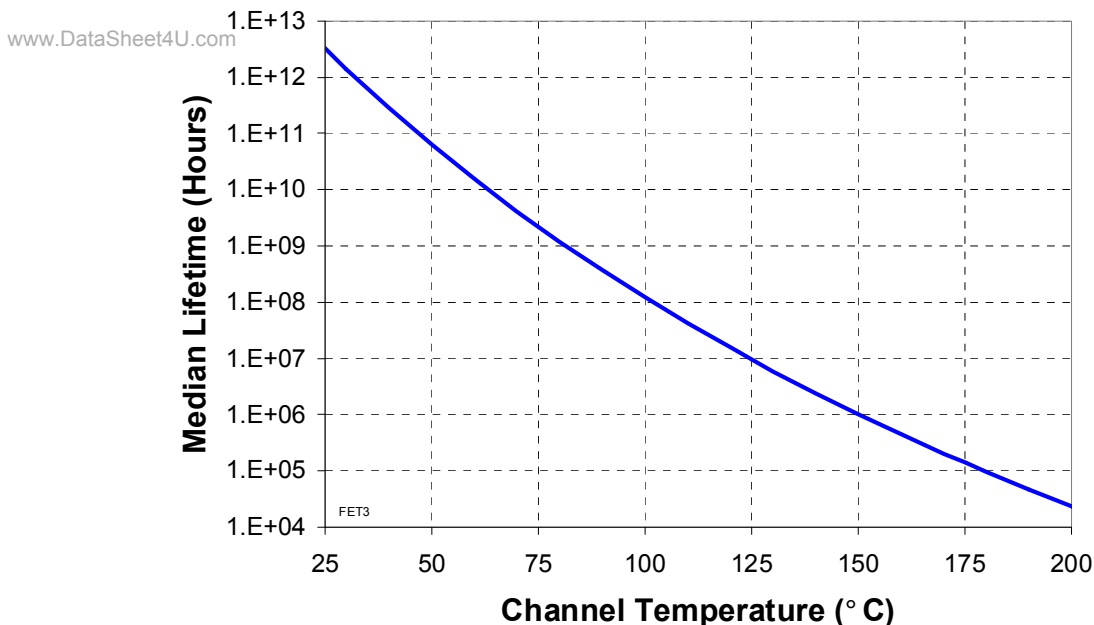

**Measured S-Parameters (75 Ω) from Application Circuit,
Vdd = 6V**

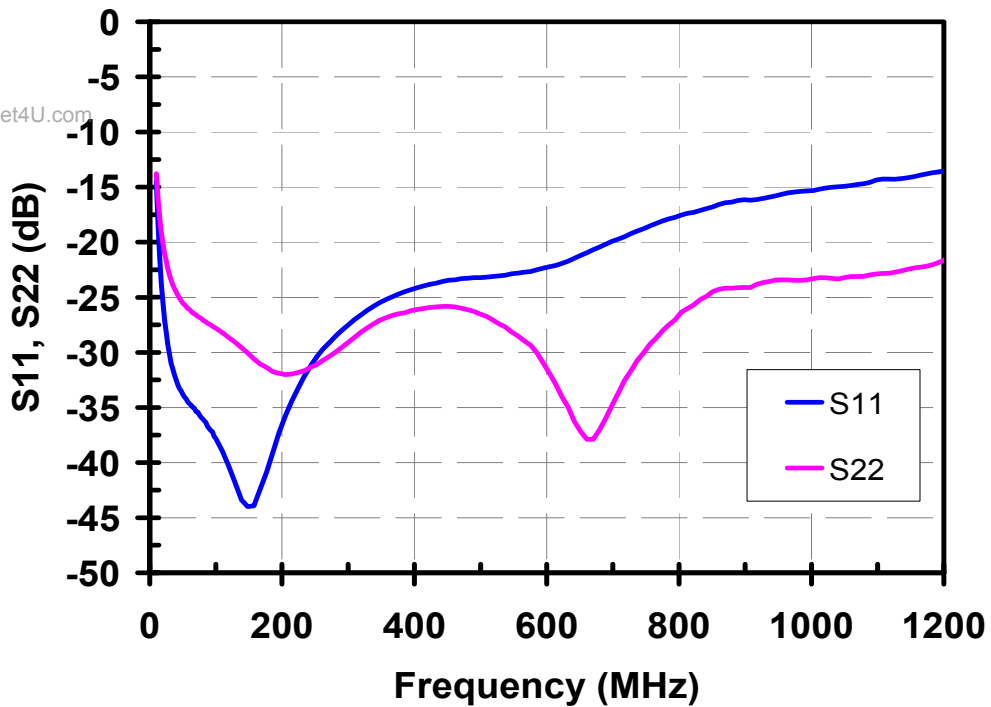
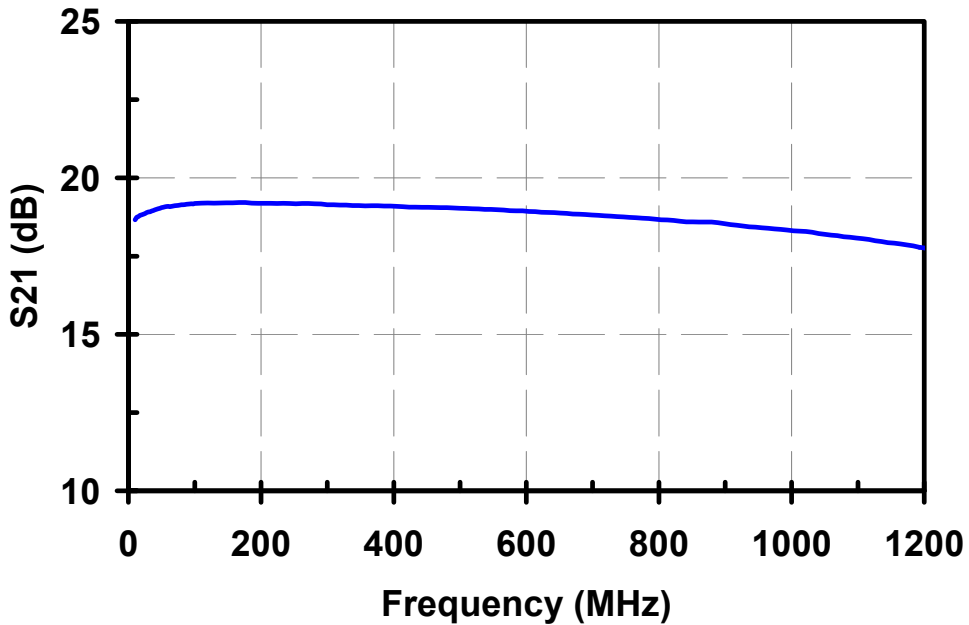

www.DataSheet4U.com

**Measured Noise Figure from Application Circuit,
Vdd = 6V**

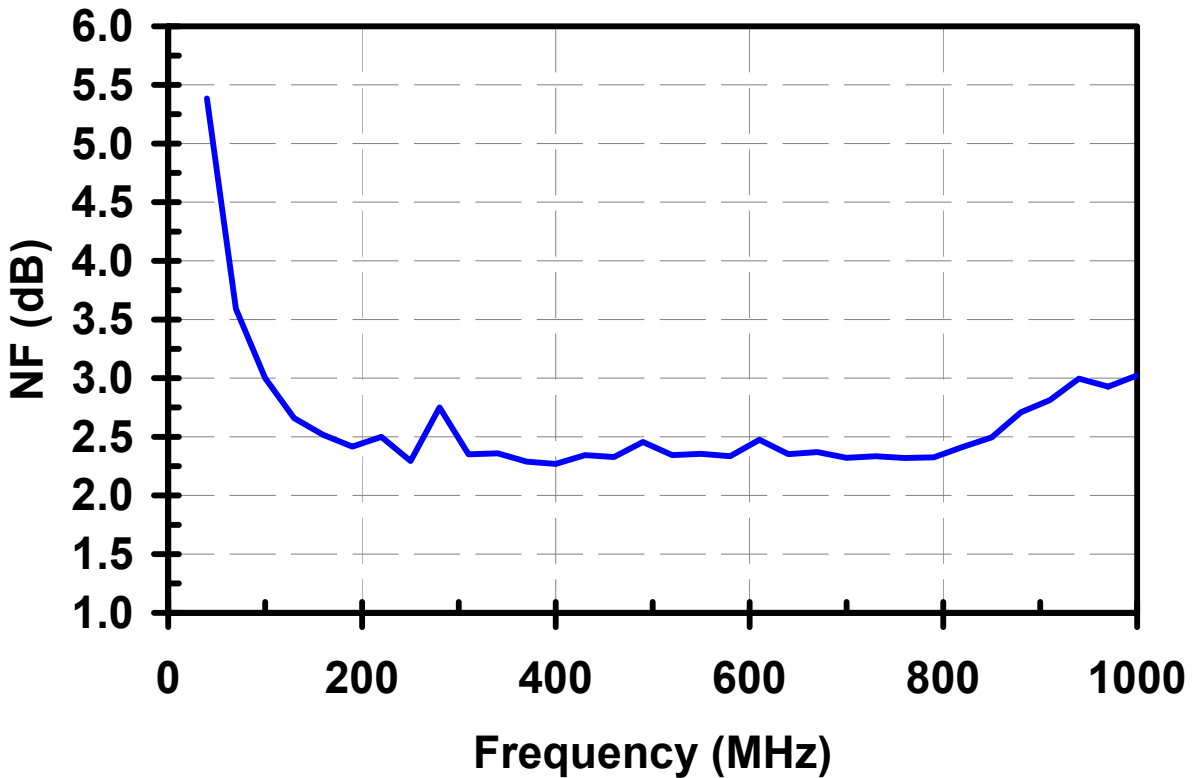

www.DataSheet4U.com

**Measured ACPR vs. Pout and Vdd (75 Ω), single 858MHz,
256-QAM channel 1/**

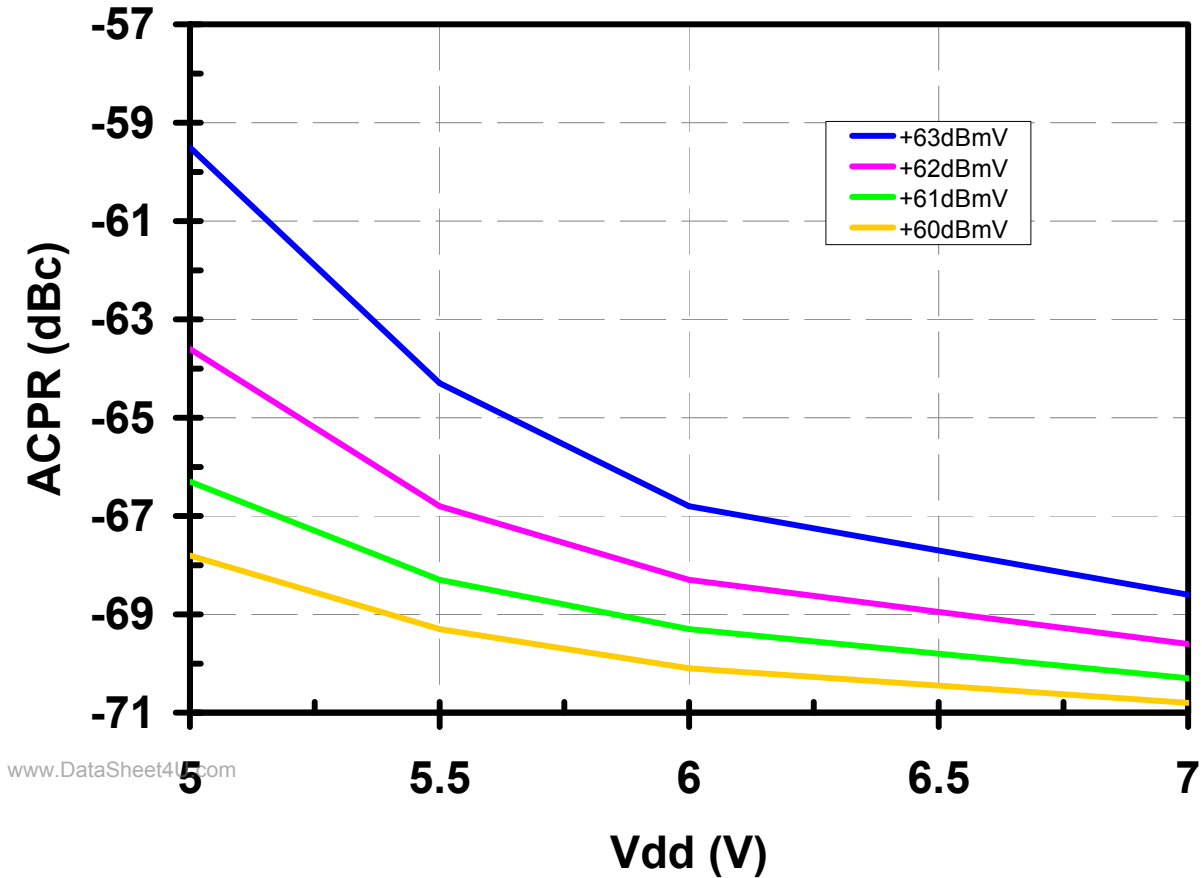

www.DataSheet4U.com

1/ Measured in the band 750kHz from the channel block edge to 6MHz from the channel block edge

Measured ACPR and Gain vs. Pout, Vdd and Frequency (75 Ω) with a single 256-QAM channel

Vdd = 5.5 V, Pout = +61 dBmV

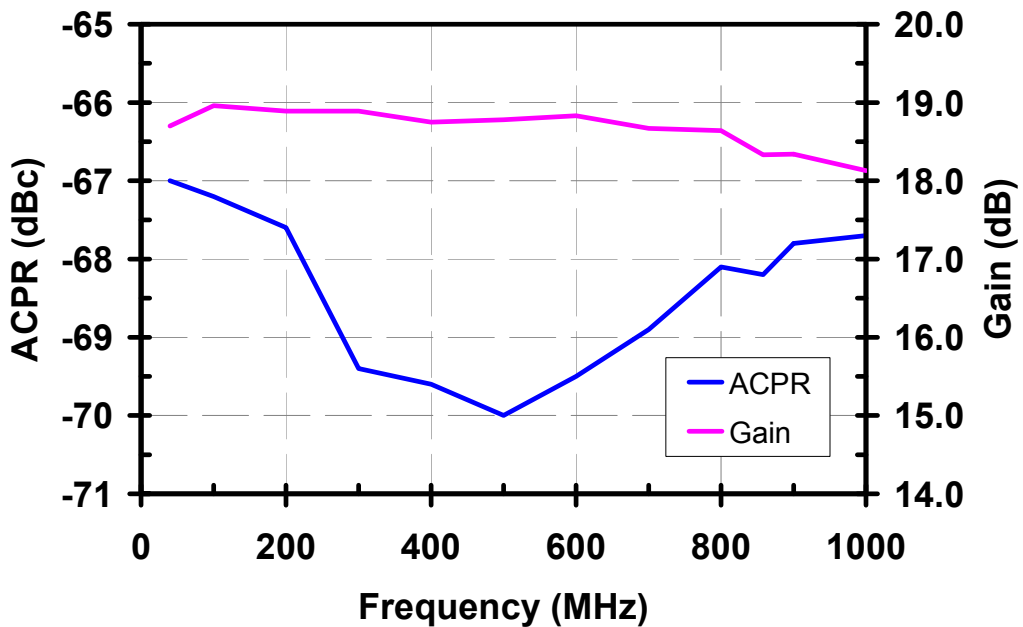

Vdd = 6 V, Pout = +62 dBmV

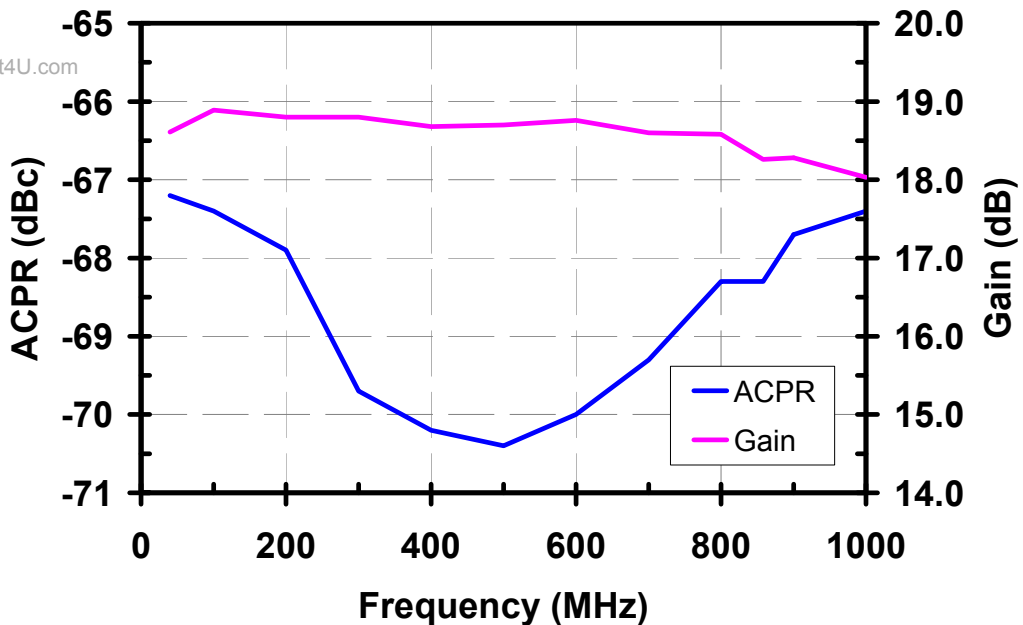

www.DataSheet4U.com

Measured ACPR vs. Vdd and Temperature (75 Ω) with a single 858MHz, 256-QAM channel at Pout = +61dBmV

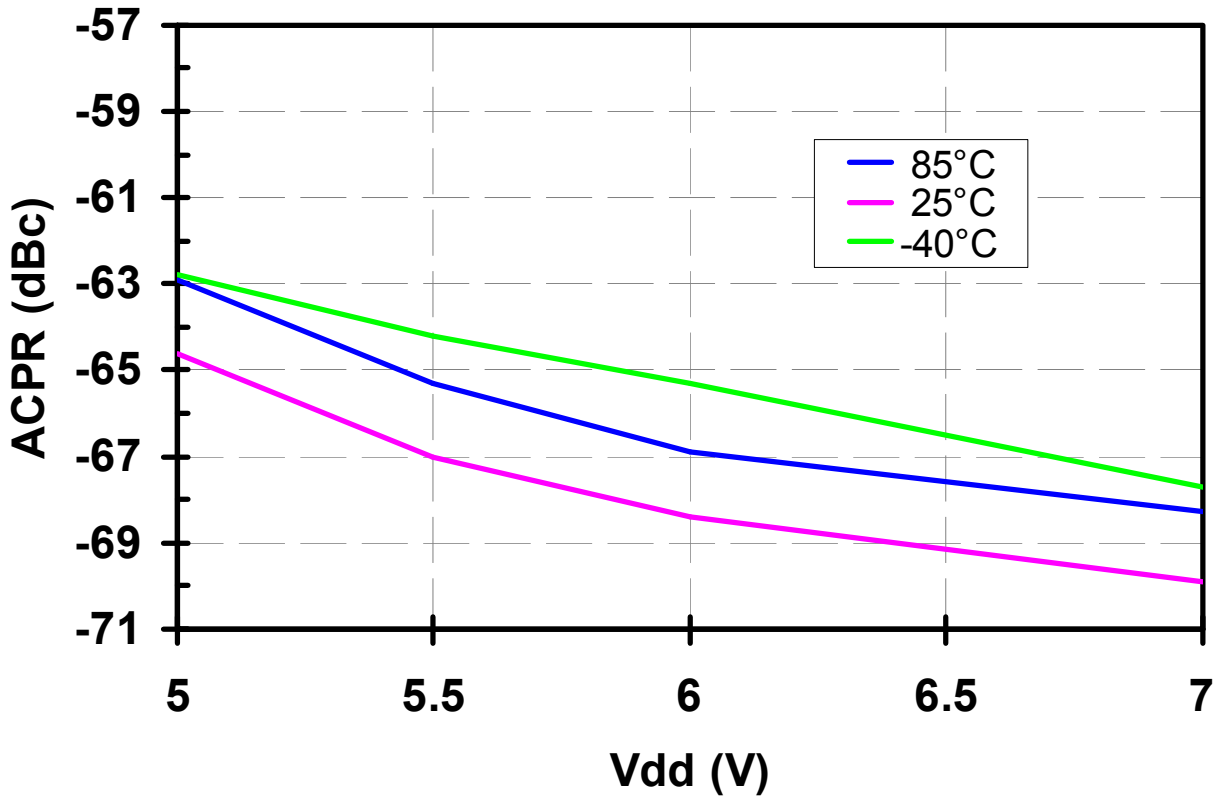

www.DataSheet4U.com

Measured Modulated Harmonics (75 Ω) from Application Circuit, Vdd = 6V 1/

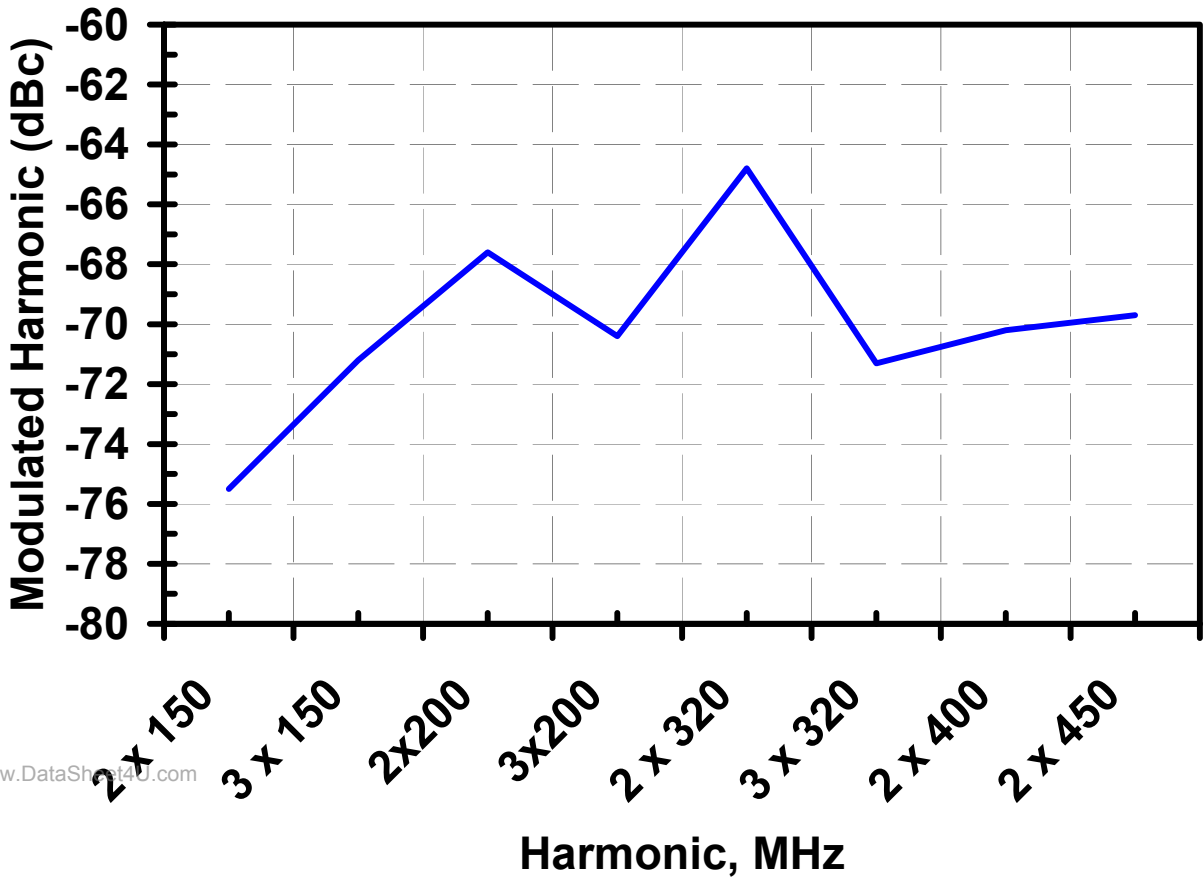

1/ Using quad 256-QAM channels at 54dBmV output power per channel at the fundamental frequencies shown

Measured Pout and Vd (75 Ω) to maintain -66dBc ACPR, single 858MHz, 256-QAM channel

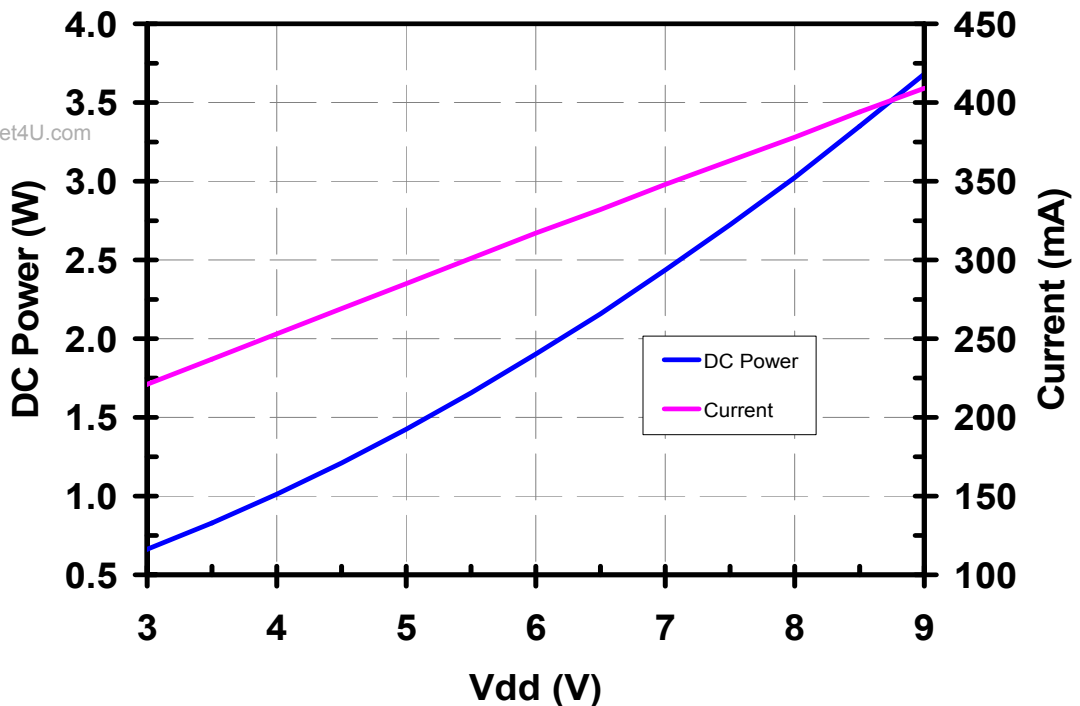
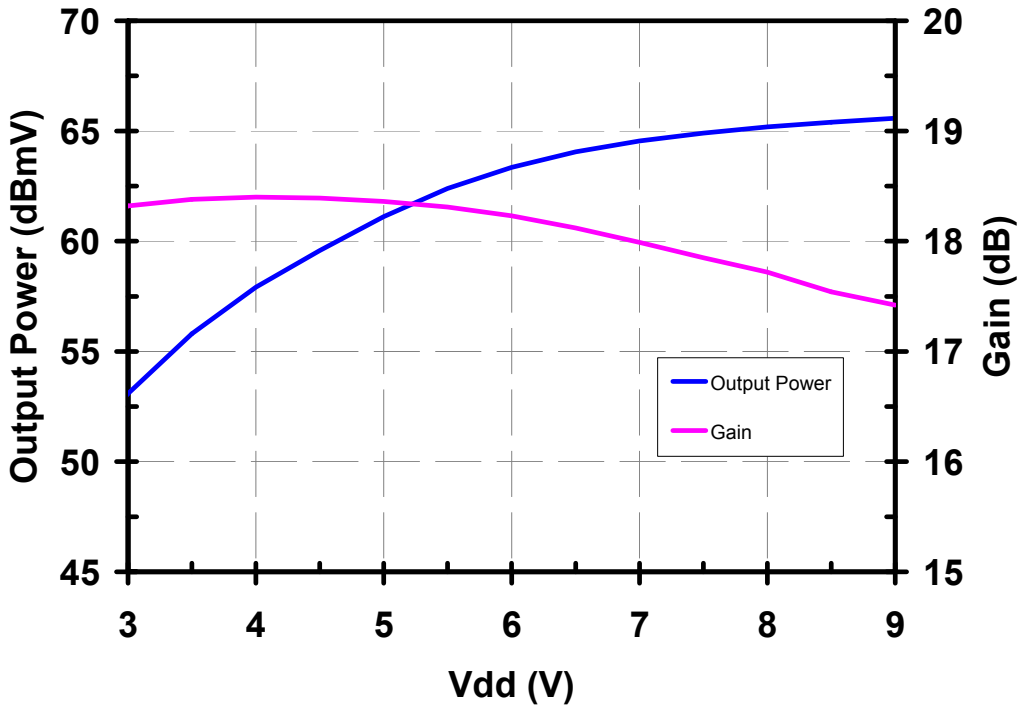

www.DataSheet4U.com

Measured CATV Parameters (75 Ω), 83 channels at different Pout, Vdd = 6V

XMD

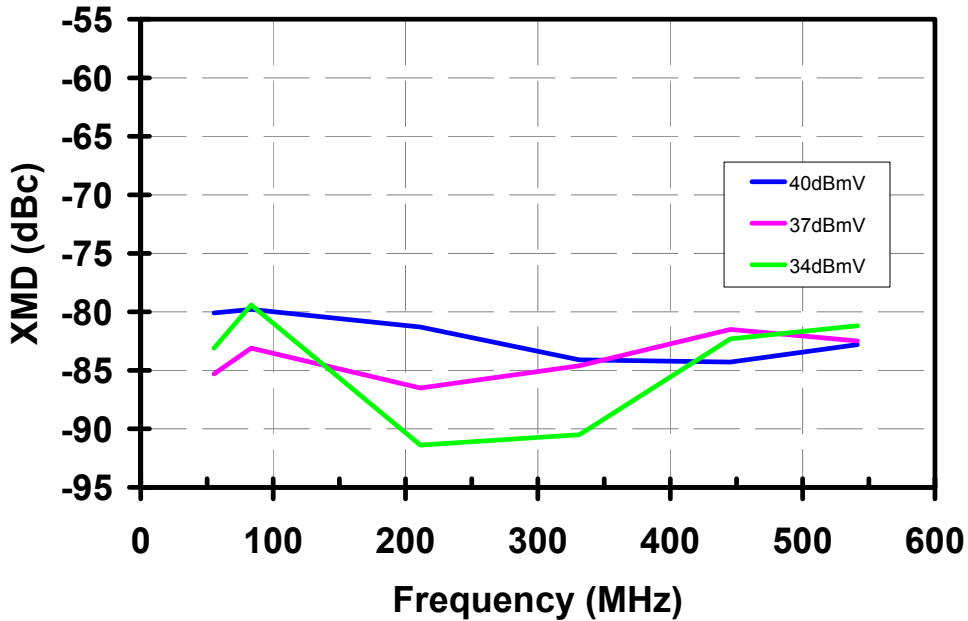

CTB

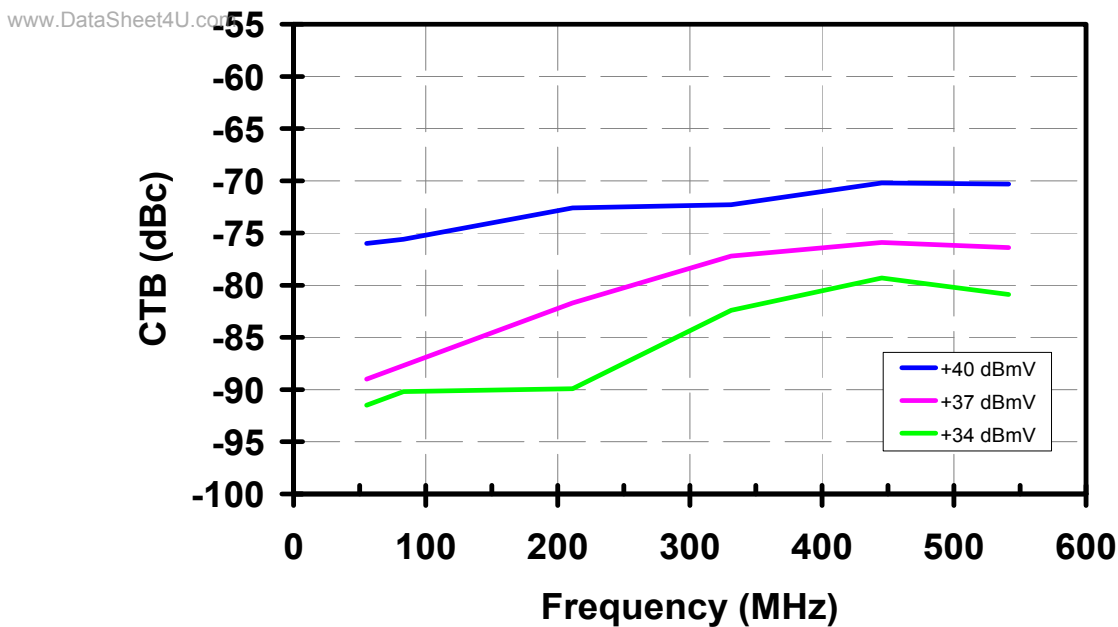

**Measured CATV Parameters (75 Ω), 83 channels at different
Pout, Vdd = 6V**

CSO

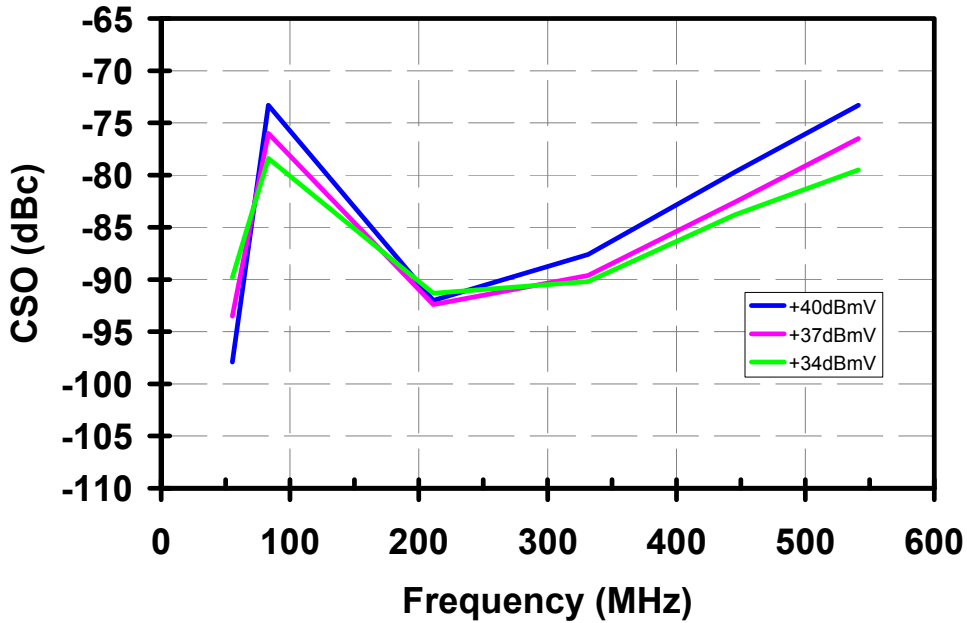

www.DataSheet4U.com

Application Circuit

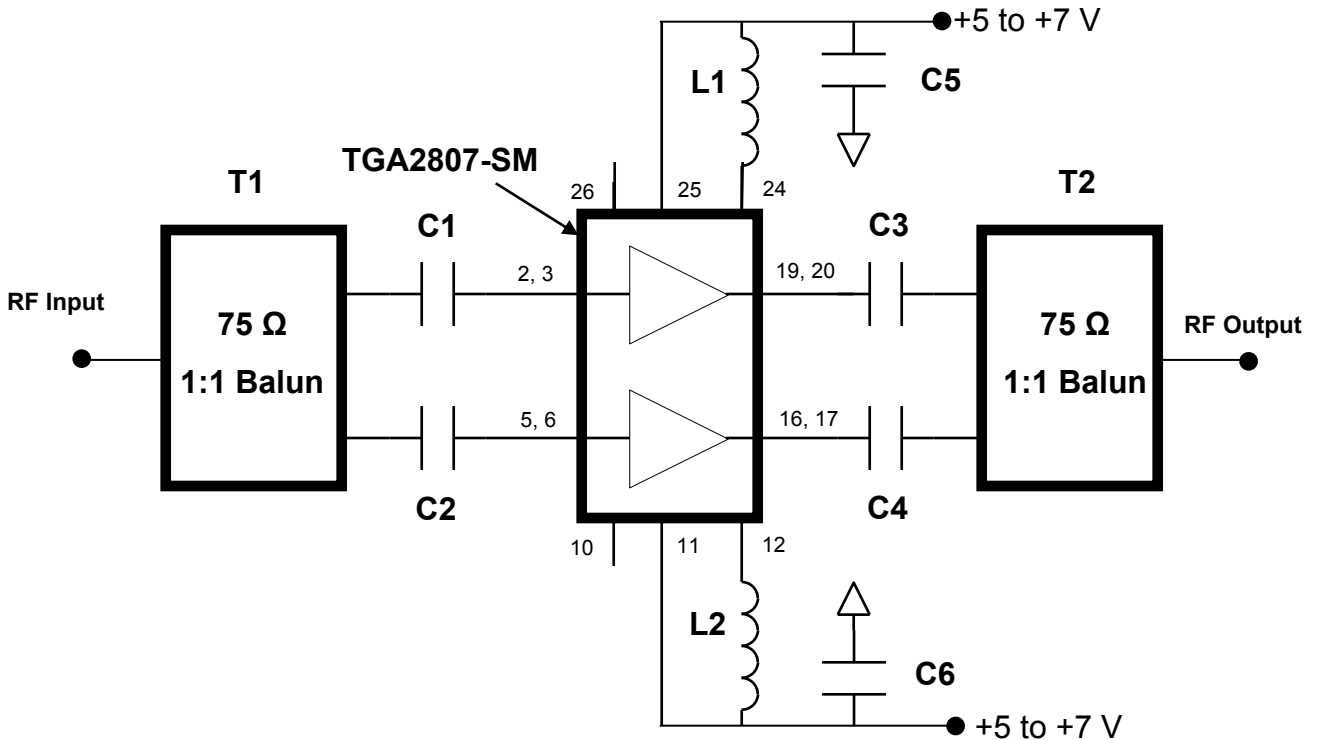

Reference	Description	Part Number
C1, C2	0.01 μ F	
C3, C4	470pF	
C5, C6	1 μ F	
L1, L2	560nH	Coilcraft 0603LS-561XGLB
T1, T2	75 Ω 1:1 Balun <u>1/</u>	Mini-Circuits ADTL1-15-75+

1/ Other manufacturers' baluns can be used, but small-signal performance, specifically S22, will be affected.

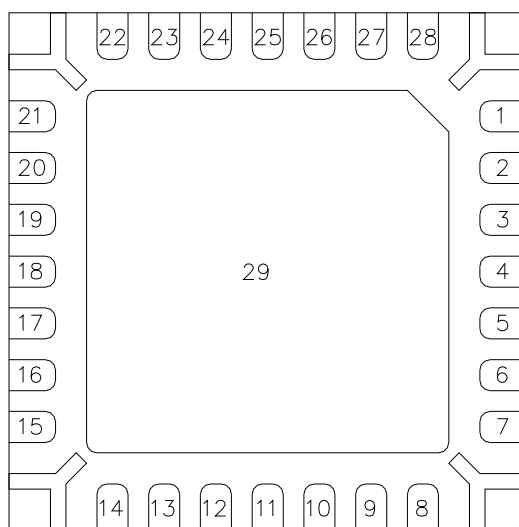

Pin	Description	Pin	Description
2	RF Input 1	16	RF Output 2
3	RF Input 1	17	RF Output 2
4, 18	NC	29	GND
5	RF Input 2	19	RF Output 1
6	RF Input 2	20	RF Output 1
1, 7, 8, 14	NC	15, 21, 22, 23	NC
9	GND	24	VDD (choked)
10	VG2 (Optional)	25	VDD
11	VDD	26	VG1 (Optional)
12	VDD (choked)	27	GND
13	Isense	28	NC

Notes: Pin 13 (Isense) is used to monitor the drain current across a 4 ohm resistor, if desired.

The voltage at pin 13 is $V_{sense} = I_{dd} * 4$ Volts.

Pins 9 and 27 are internally connected to GND but may be left open.

NC pins (1,7,8,14,15,21,22,23,28) are not connected internally; they may be grounded externally, if desired.

Pins 10 and 26 are internally connected and may be left open.

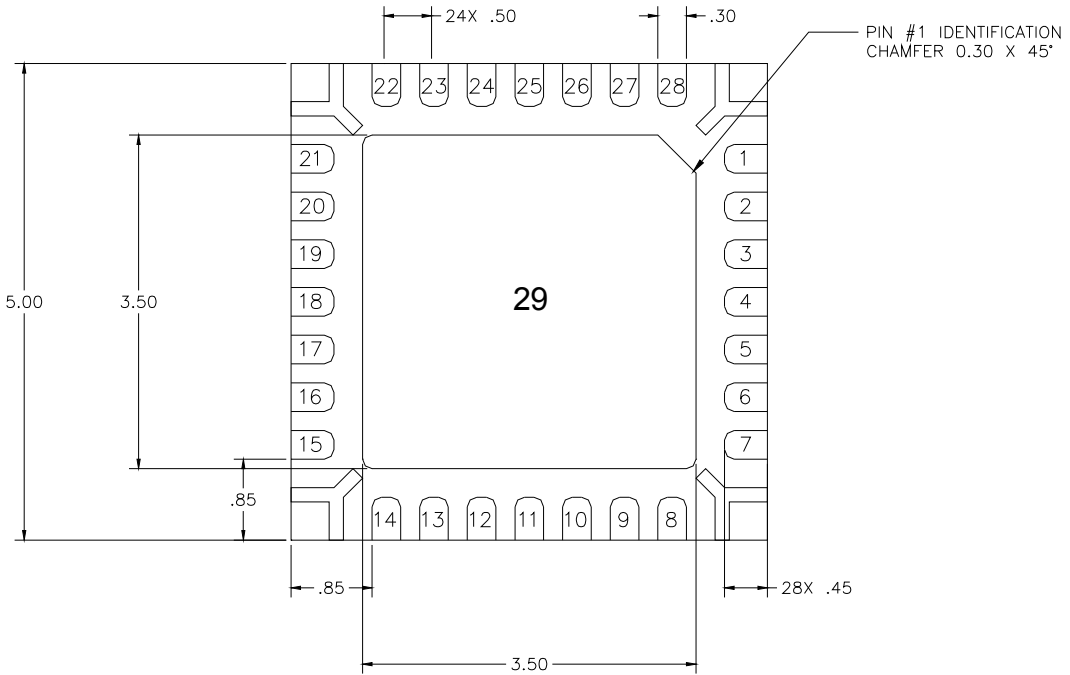

BOTTOM VIEW

www.DataSheet4U.com

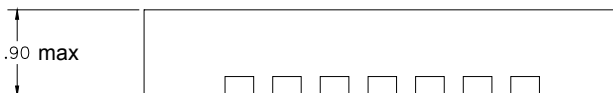

SIDE VIEW

Dimensions are in mm.

Recommended Assembly Diagram

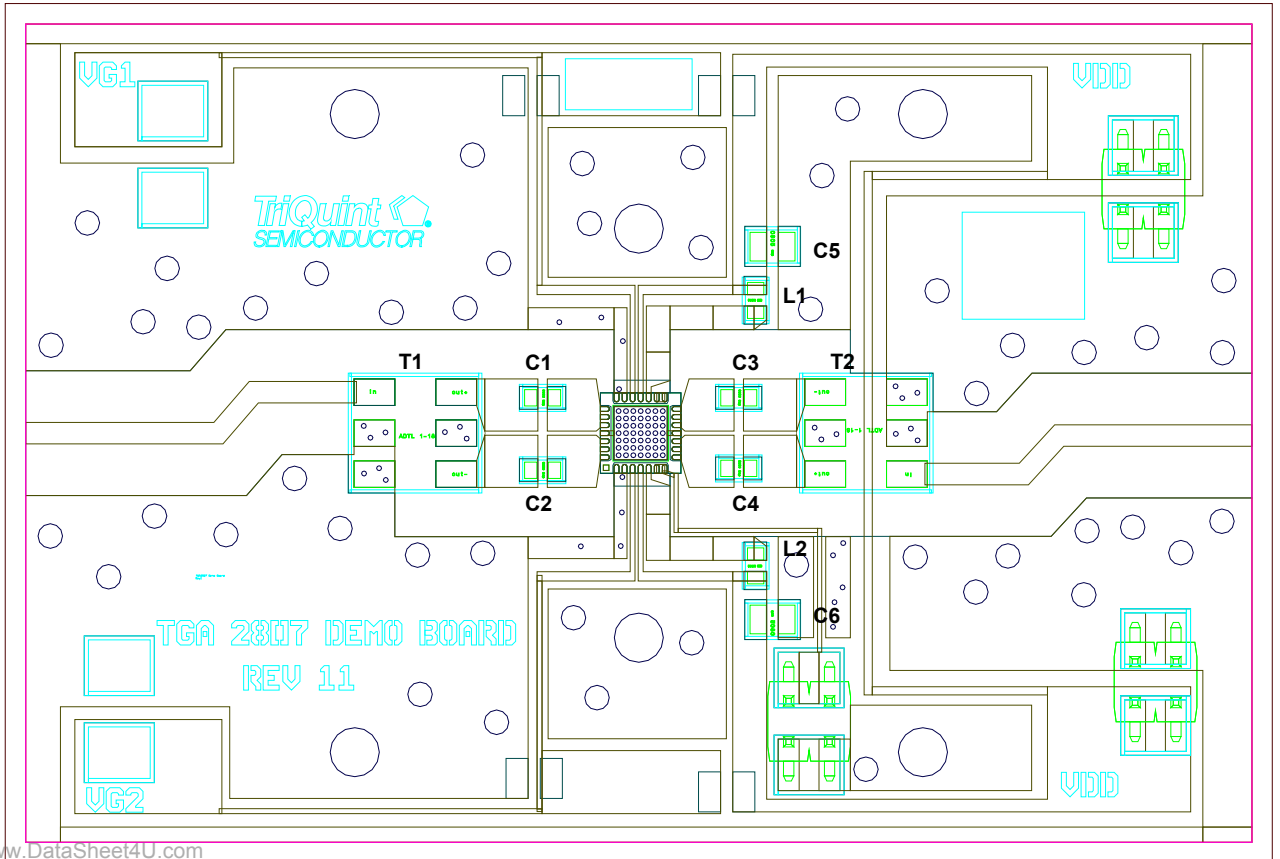

www.DataSheet4U.com

Board material: 1.57mm thick FR4
 Forty nine (49) open plated vias in center of land pattern
 Vias are 12 mil diameter with 18 mil center-to-center spacing.

Assembly Notes

Recommended Surface Mount Package Assembly

- Proper ESD precautions must be followed while handling packages.
- Clean the board with acetone. Rinse with alcohol. Allow the circuit to fully dry.
- TriQuint recommends using a conductive solder paste for attachment. Follow solder paste and reflow oven vendors' recommendations when developing a solder reflow profile. Typical solder reflow profiles are listed in the table below.
- Hand soldering is not recommended. Solder paste can be applied using a stencil printer or dot placement. The volume of solder paste depends on PCB and component layout and should be well controlled to ensure consistent mechanical and electrical performance.
- Clean the assembly with alcohol.

Typical Solder Reflow Profiles

Reflow Profile	SnPb	Pb Free
Ramp-up Rate	3 °C/sec	3 °C/sec
Activation Time and Temperature	60 – 120 sec @ 140 – 160 °C	60 – 180 sec @ 150 – 200 °C
Time above Melting Point	60 – 150 sec	60 – 150 sec
Max Peak Temperature	240 °C	260 °C
Time within 5 °C of Peak Temperature	10 – 20 sec	10 – 20 sec
Ramp-down Rate	4 – 6 °C/sec	4 – 6 °C/sec

Ordering Information

Part	Package Style
TGA2807-SM, TAPE AND REEL	5mm x 5mm QFN Surface Mount, TAPE AND REEL

GaAs MMIC devices are susceptible to damage from Electrostatic Discharge. Proper precautions should be observed during handling, assembly and test.