

2 Watt Packaged Amplifier

TGA2902-SCC-SG



Preliminary Measured Performance

Bias Conditions: $V_D = 7.5V$, $I_D = 650mA$

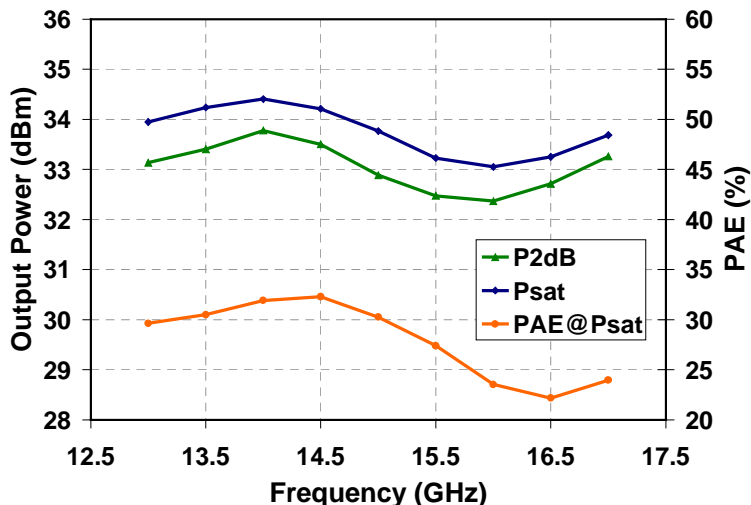
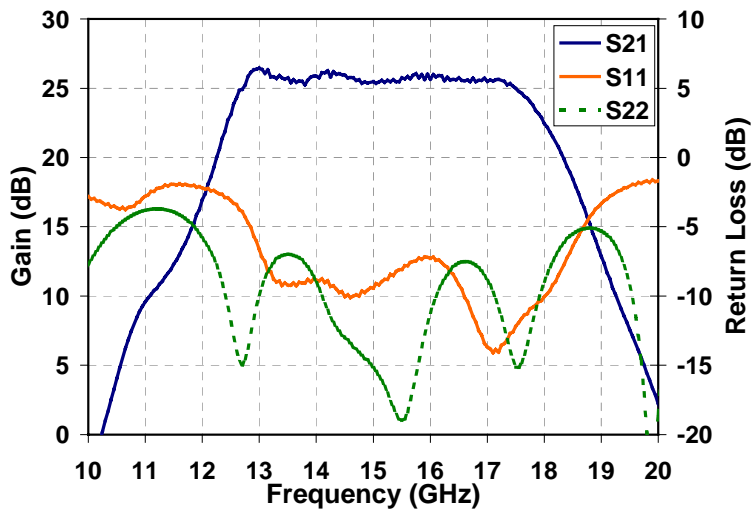

Key Features and Performance

- 34 dBm Midband Psat
- 26 dB Nominal Gain
- 8 dB Typical Return Loss
- 13 - 17 GHz Frequency Range
- Directional Power Detector with Reference
- 0.25 μ m pHEMT Technology
- Bias Conditions: 7.5V, 650mA
- Package Dimensions: 9.4 x 6.4 x 1.8 mm (370 x 250 x 71 mils)
- Lead free and RoHS Compliant

Primary Applications

- VSAT
- Point to Point

**TABLE I
MAXIMUM RATINGS**

| Symbol | Parameter | Value | Notes |
|------------------|--------------------------------------|---------------|-------------------------------|
| V _D | Drain Voltage | 8 V | <u>1/</u> <u>2/</u> |
| V _G | Gate Voltage Range | -5V to 0V | <u>1/</u> |
| I _D | Drain Supply Current (Quiescent) | 1300 mA | <u>1/</u> <u>2/</u> |
| I _G | Gate Supply Current | 18 mA | <u>1/</u> |
| P _{IN} | Input Continuous Wave Power | 24 dBm | <u>1/</u> <u>2/</u> |
| P _D | Power Dissipation | 6.15 W | <u>1/</u> <u>2/</u> <u>3/</u> |
| T _{CH} | Operating Channel Temperature | 150 °C | <u>4/</u> |
| T _M | Mounting Temperature (30 Seconds) | 220 °C | |
| T _{STG} | Storage Temperature | -65 to 150 °C | |

- 1/ These ratings represent the maximum operable values for this device
- 2/ Combinations of supply voltage, supply current, input power, and output power shall not exceed P_D at a package base temperature of 70°C
- 3/ When operated at this bias condition with a baseplate temperature of 70°C, the MTTF is reduced from 4.8E+6 to 1.0E+6 hours
- 4/ Junction operating temperature will directly affect the device median time to failure (MTTF). For maximum life, it is recommended that junction temperatures be maintained at the lowest possible levels.

**TABLE II
THERMAL INFORMATION**

| Parameter | Test Conditions | T _{CH} (°C) | R _{θJC} (°C/W) | MTTF (hrs) |
|--|--|-------------------------|----------------------------|---------------|
| R _{θJC} Thermal Resistance (Channel to Backside of Package) | V _D = 7.5V I _D = 650mA P _{DISS} = 4.88W T _{BASE} = 70°C | 132.3 | 12.8 | 4.8E+6 |

TABLE III
TGA2902-1-SCC-SG RF CHARACTERIZATION TABLE
 (T_A = 25°C, Nominal)
 (V_d = 7.5V, I_d = 650mA ±5%)

| Symbol | Parameter | Test Conditions | Limits | | | Units | Notes |
|----------------|---|-----------------|--------|------|------|-------|---------------------|
| | | | Min | Typ | Max | | |
| Gain | Small Signal Gain | F = 13-17 | 22 | 26 | 29 | dB | <u>1/</u> <u>2/</u> |
| IRL | Input Return Loss | F = 13-17 | | 8 | | dB | |
| ORL | Output Return Loss | F = 13-17 | | 8 | | dB | |
| PSAT | Output Power @ Pin = +14dBm | F = 13-17 | 32.5 | 33.5 | | dBm | <u>1/</u> |
| P2dB | Output Power @ 2dB Gain Compression | F = 13-17 | | 32.5 | | dBm | |
| I _D | Drain Current @ Pin = +14dBm | F = 13-17 | | 1100 | 1300 | mA | |
| I _G | Gate Current @ Pin = +14dBm | F = 13-17 | | 6 | 18 | mA | |
| IP3 | Third Order Intercept Point | F = 13-17 | | 38 | | dBm | |
| PAE | Power Added Efficiency @ Pin = +14dBm | F = 13-17 | | 30 | | % | |

Note: Table IV Lists the RF Characteristics of typical devices as determined by fixtured measurements.

1/ Data taken at 500MHz steps

2/ Maximum Pin = -10dBm

TABLE IV
TGA2902-2-SCC-SG RF CHARACTERIZATION TABLE
(T_A = 25°C, Nominal)
(V_d = 7.5V, I_d = 650mA ±5%)

| Symbol | Parameter | Test Conditions | Limits | | | Units | Notes |
|----------------|---|-----------------|--------|------|------|-------|---------------------|
| | | | Min | Typ | Max | | |
| Gain | Small Signal Gain | F = 13.75-14.5 | 23 | 26 | 29 | dB | <u>1/</u> <u>2/</u> |
| IRL | Input Return Loss | F = 13.75-14.5 | | 8 | | dB | |
| ORL | Output Return Loss | F = 13.75-14.5 | | 8 | | dB | |
| PSAT | Output Power @ Pin = +14dBm | F = 13.75-14.5 | 33.5 | 34.0 | | dBm | <u>1/</u> |
| P2dB | Output Power @ 2dB Gain Compression | F = 13.75-14.5 | | 33.5 | | dBm | |
| I _D | Drain Current @ Pin = +14dBm | F = 13.75-14.5 | | 1100 | 1300 | mA | |
| I _G | Gate Current @ Pin = +14dBm | F = 13.75-14.5 | | 6 | 18 | mA | |
| IP3 | Third Order Intercept Point | F = 13.75-14.5 | | 38.5 | | dBm | |
| PAE | Power Added Efficiency @ Pin = +14dBm | F = 13.75-14.5 | | 30 | | % | |

Note: Table III Lists the RF Characteristics of typical devices as determined by fixtured measurements.

1/ Data taken at 250MHz steps

2/ Maximum Pin = -10dBm

Typical Fixtured Performance

Vd=7.5V, Idq=650mA

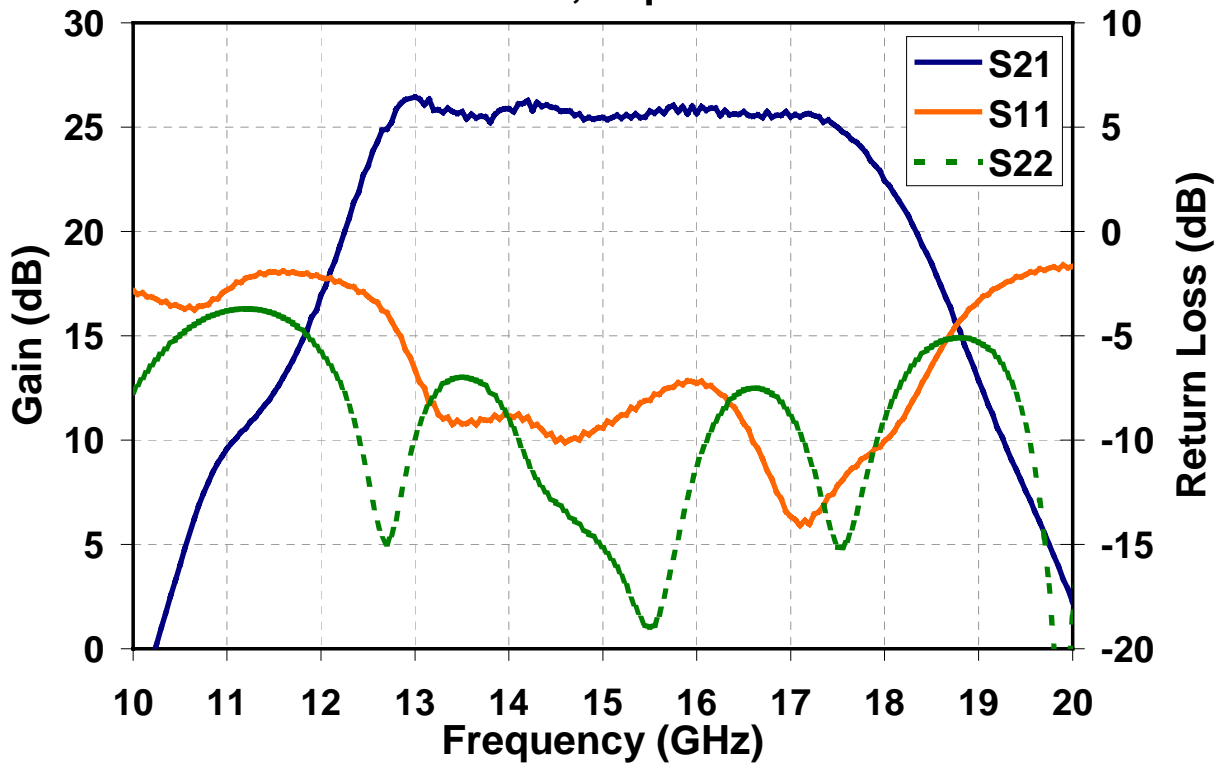

Vd=7.5V, Idq=650mA

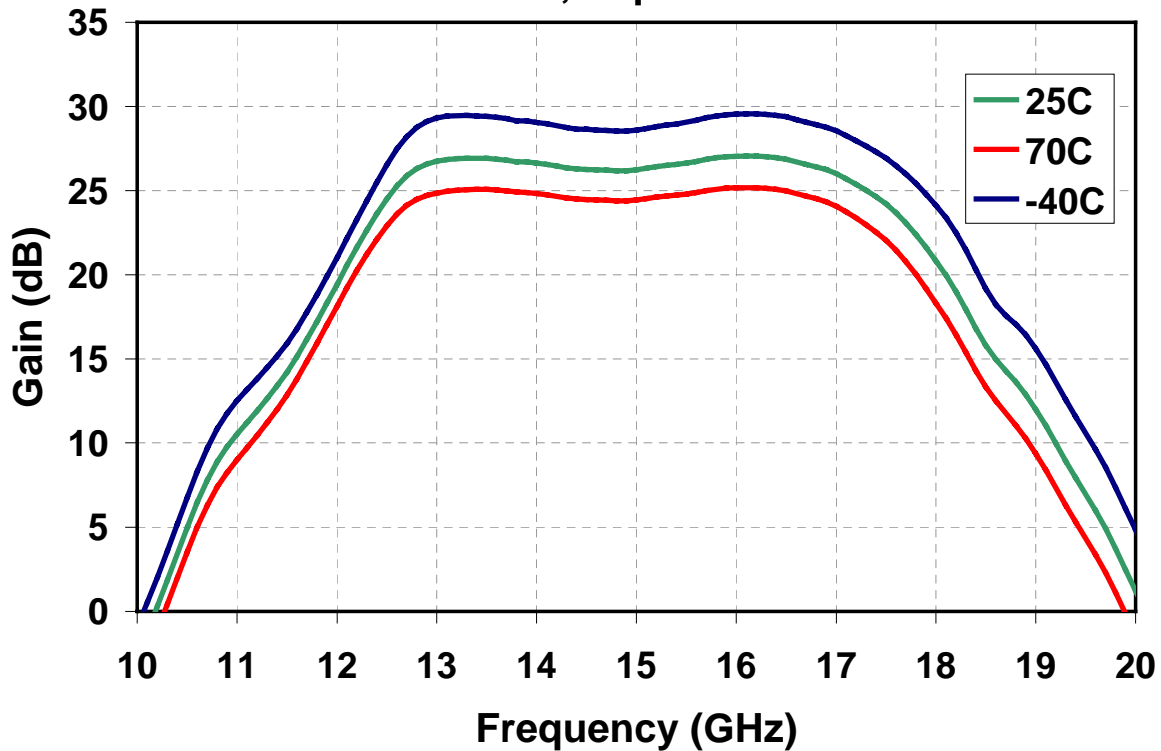

Typical Fixtured Performance

Vd=5V, Idq=650mA

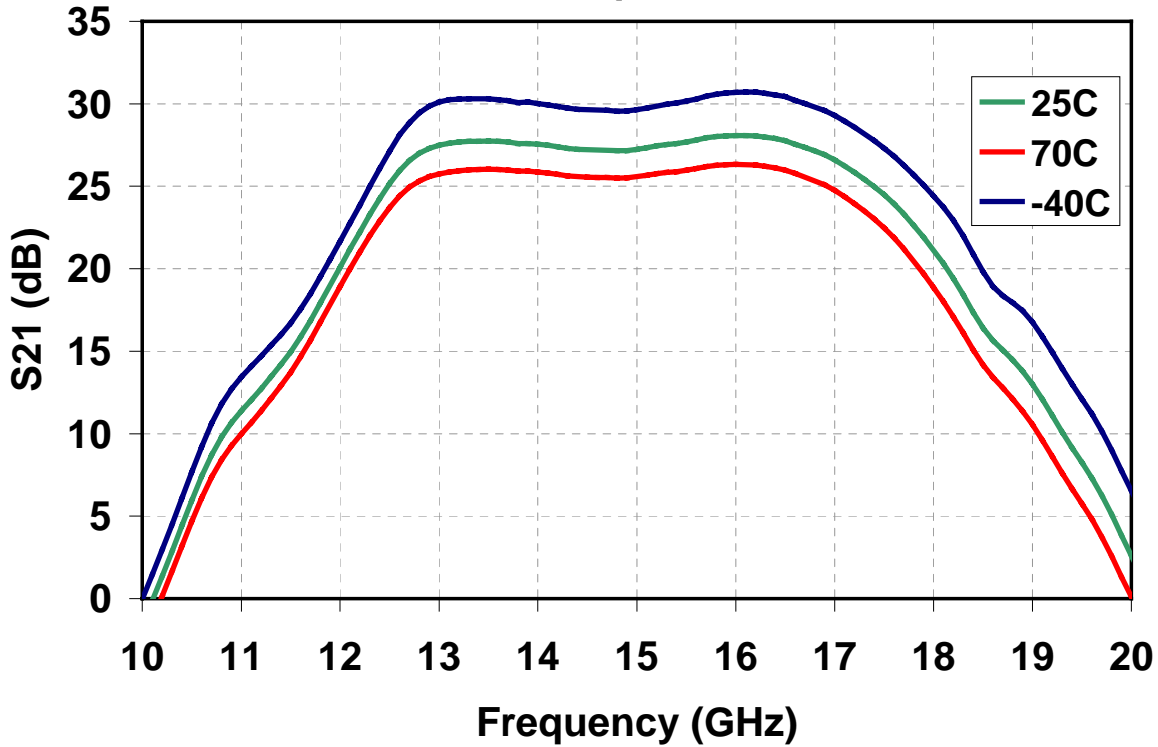

Vd=7.5V, Idq=650mA

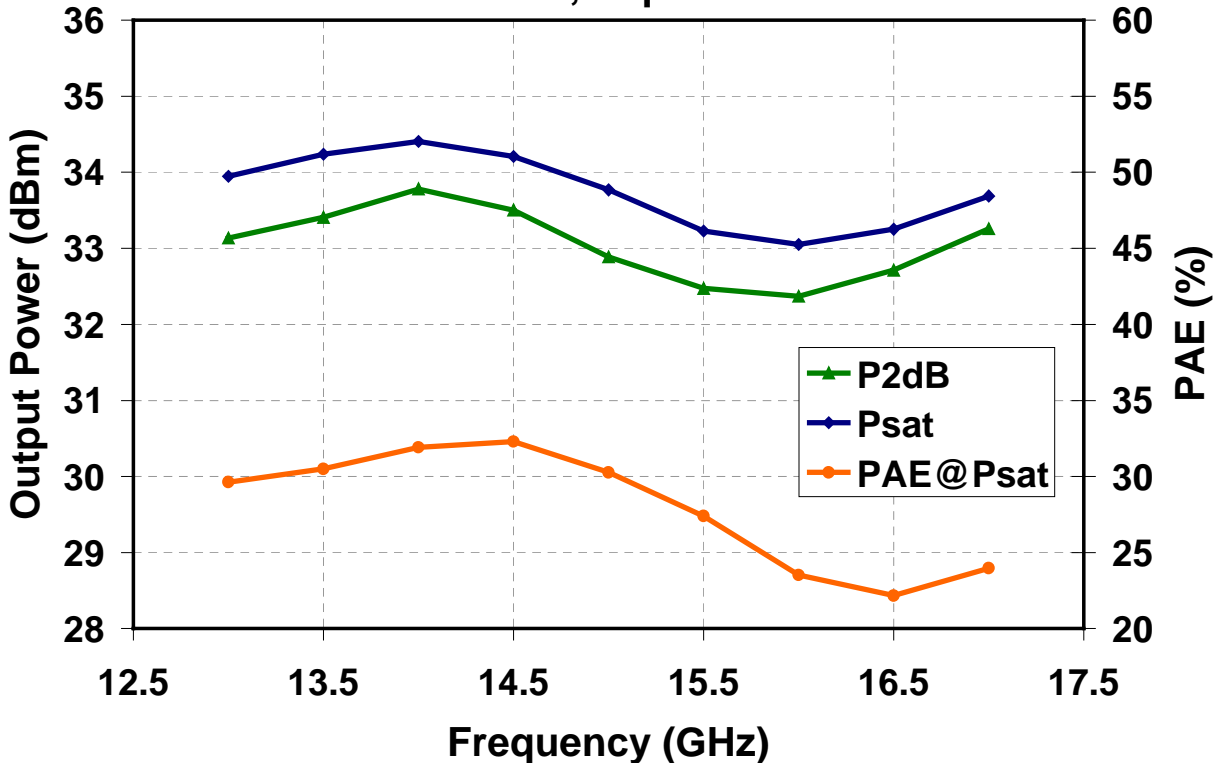

Typical Fixtured Performance

Vd=7.5V, Idq=650mA, f=14GHz

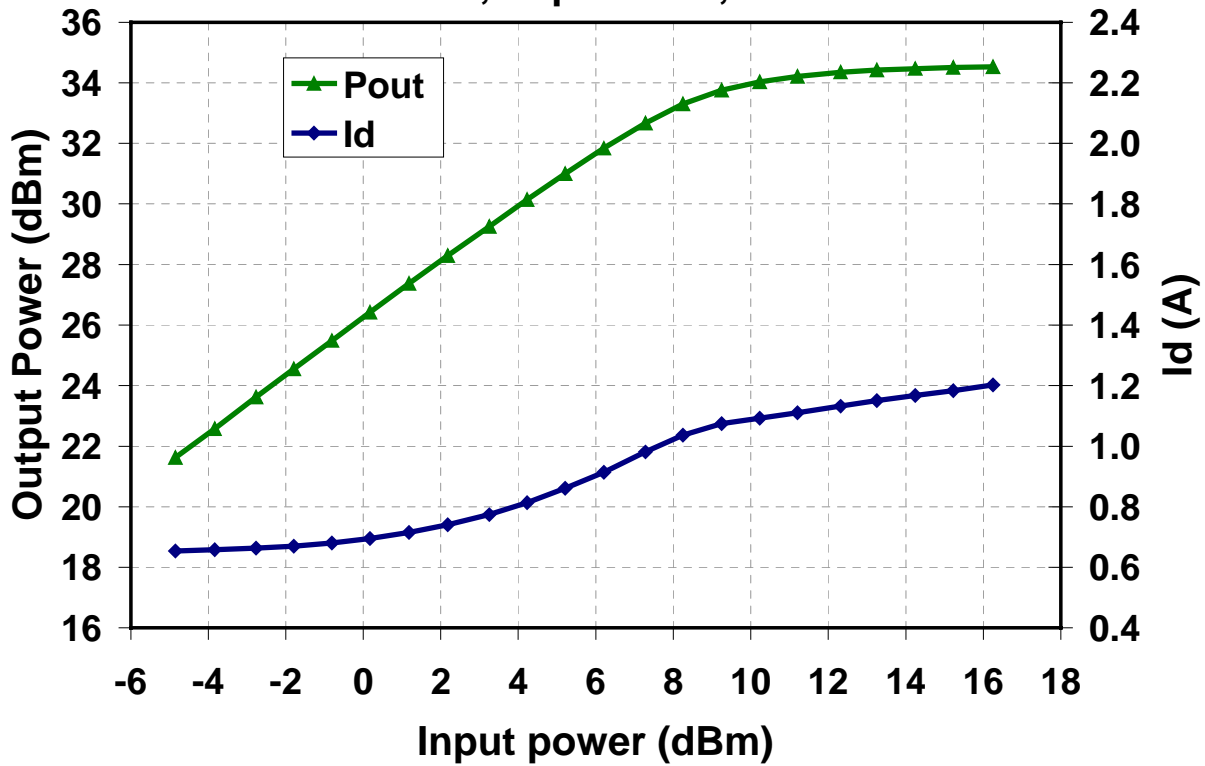

Vd=5V, Idq=650mA

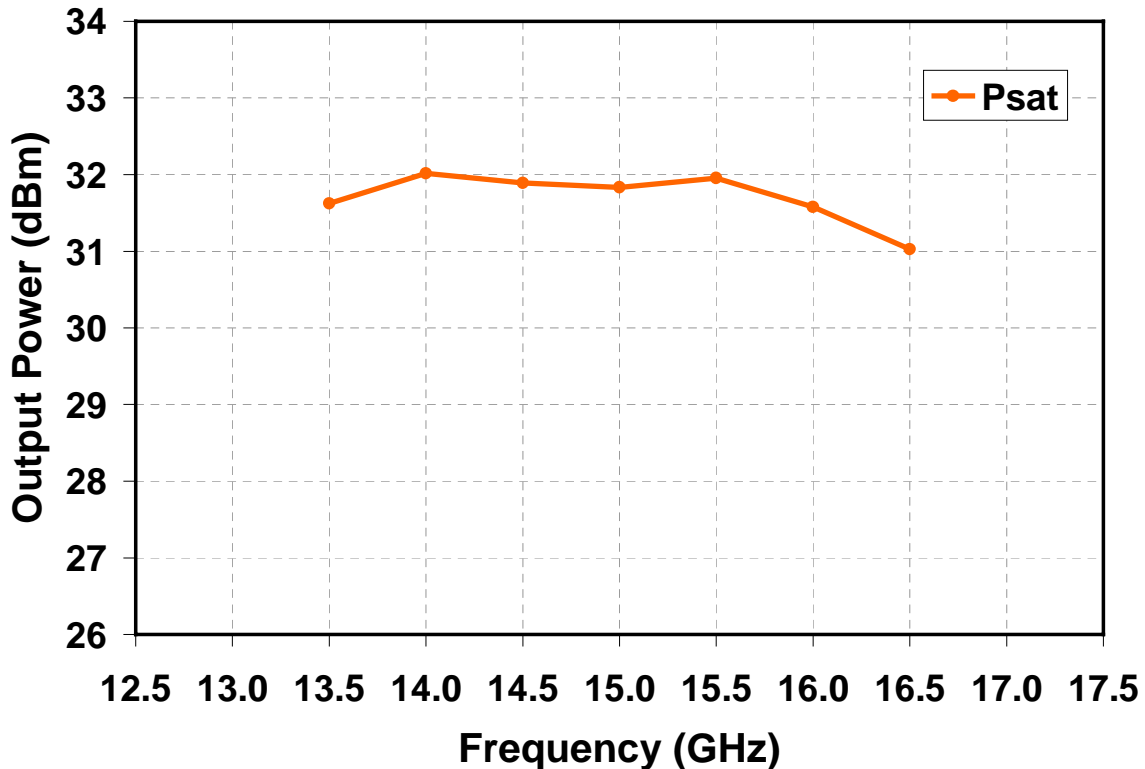

Typical Fixtured Performance

Vd=5V, Idq=650mA, f=14GHz

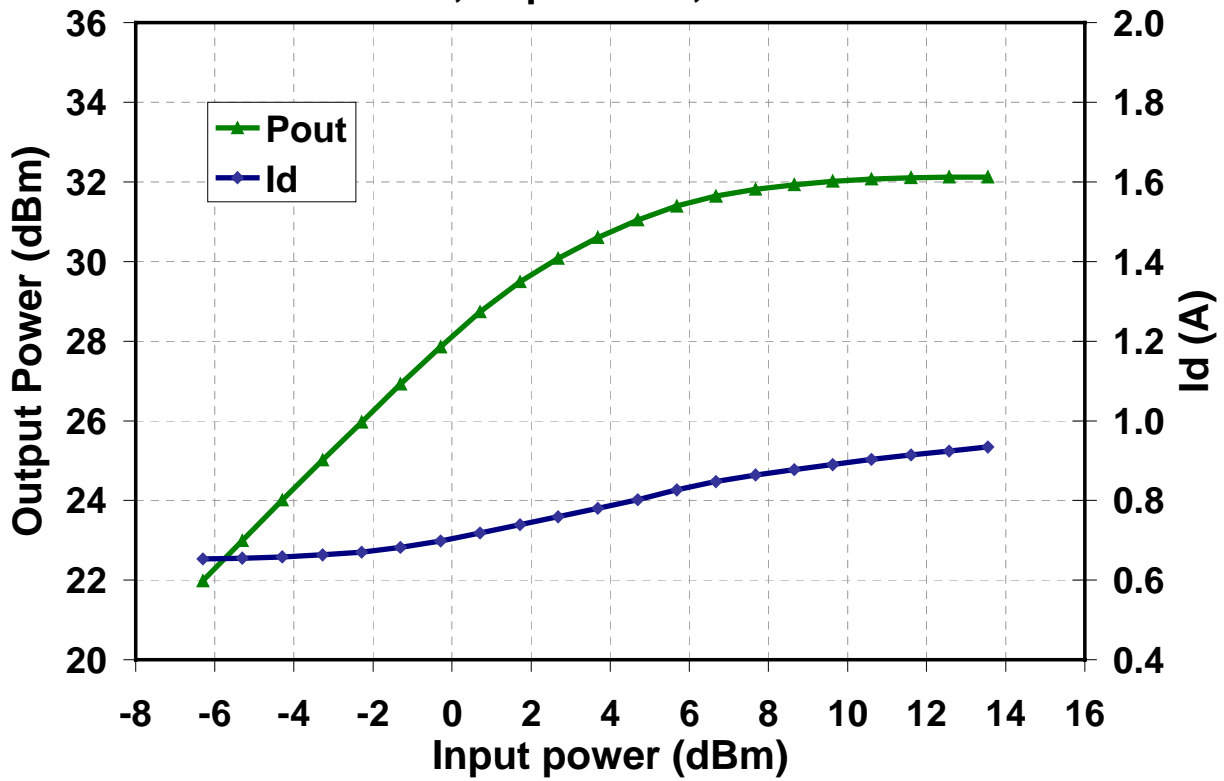

Vd=7.5V, Idq=650mA

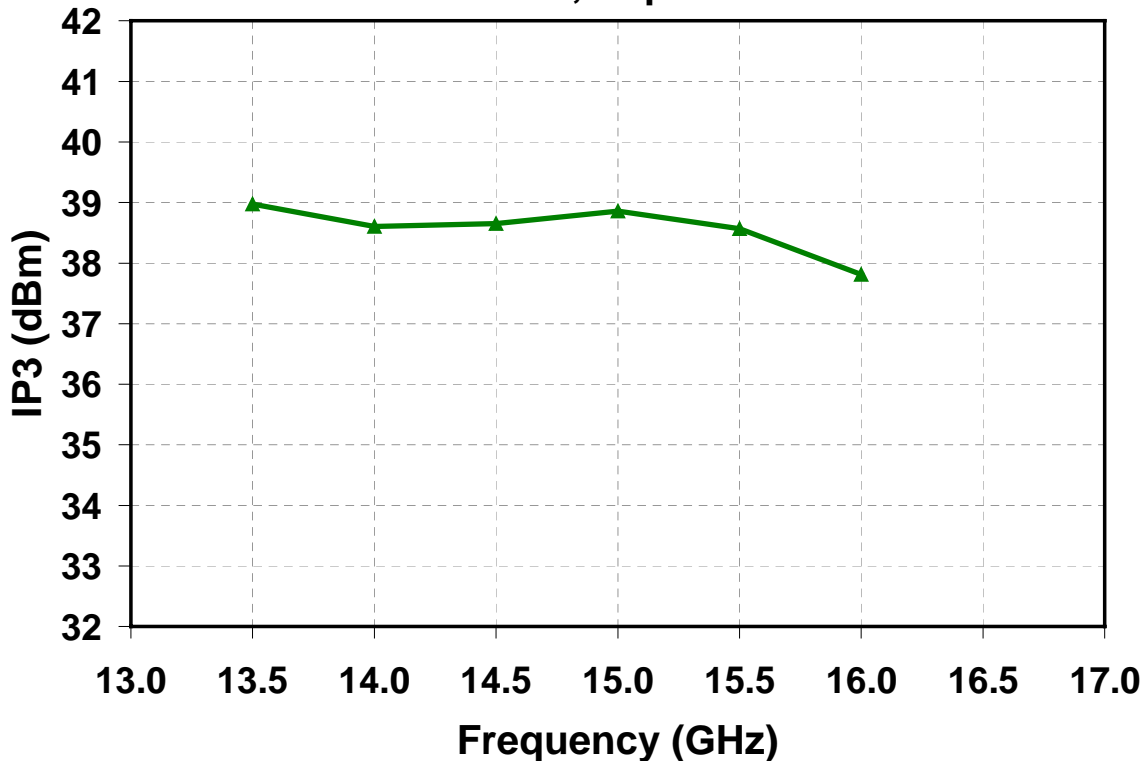

Typical Fixtured Performance

Vd=7.5V, Id=650mA

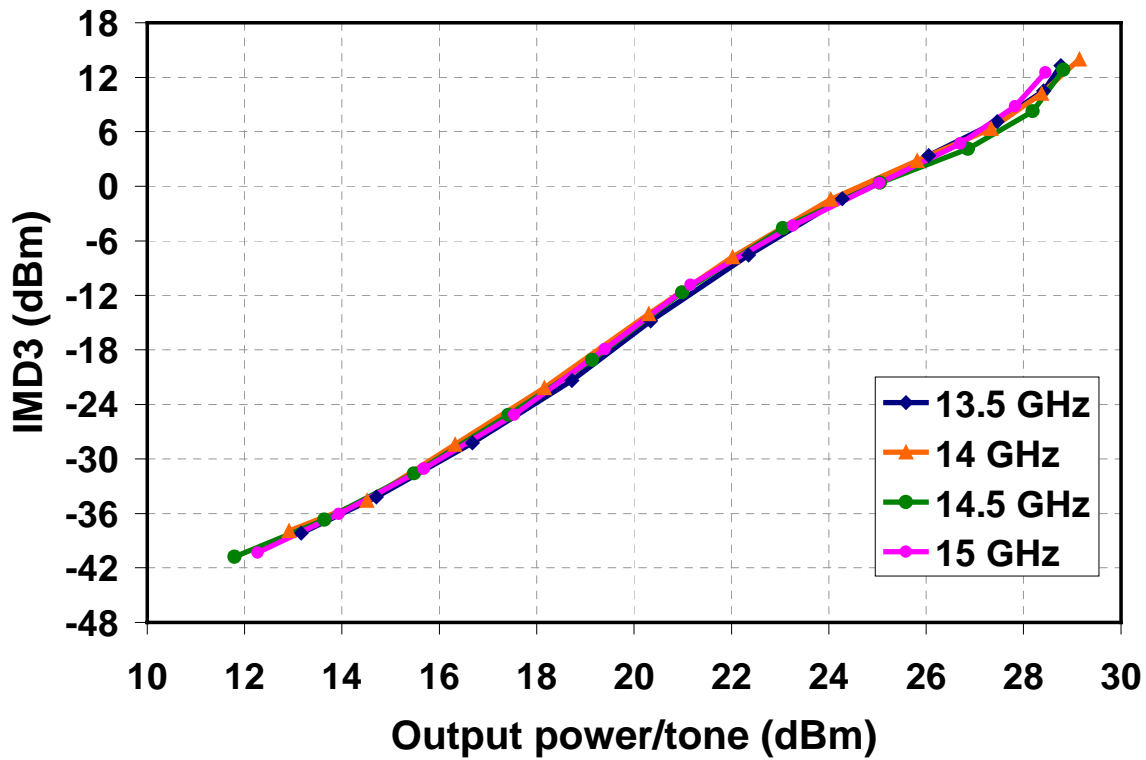

Power Detector

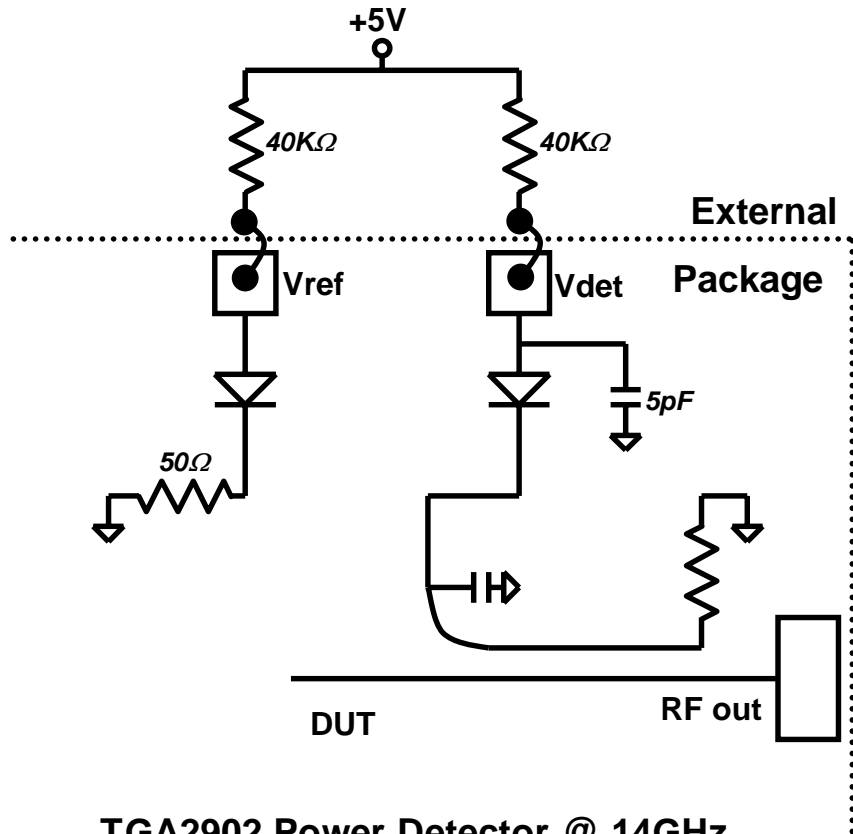

TGA2902 Power Detector @ 14GHz

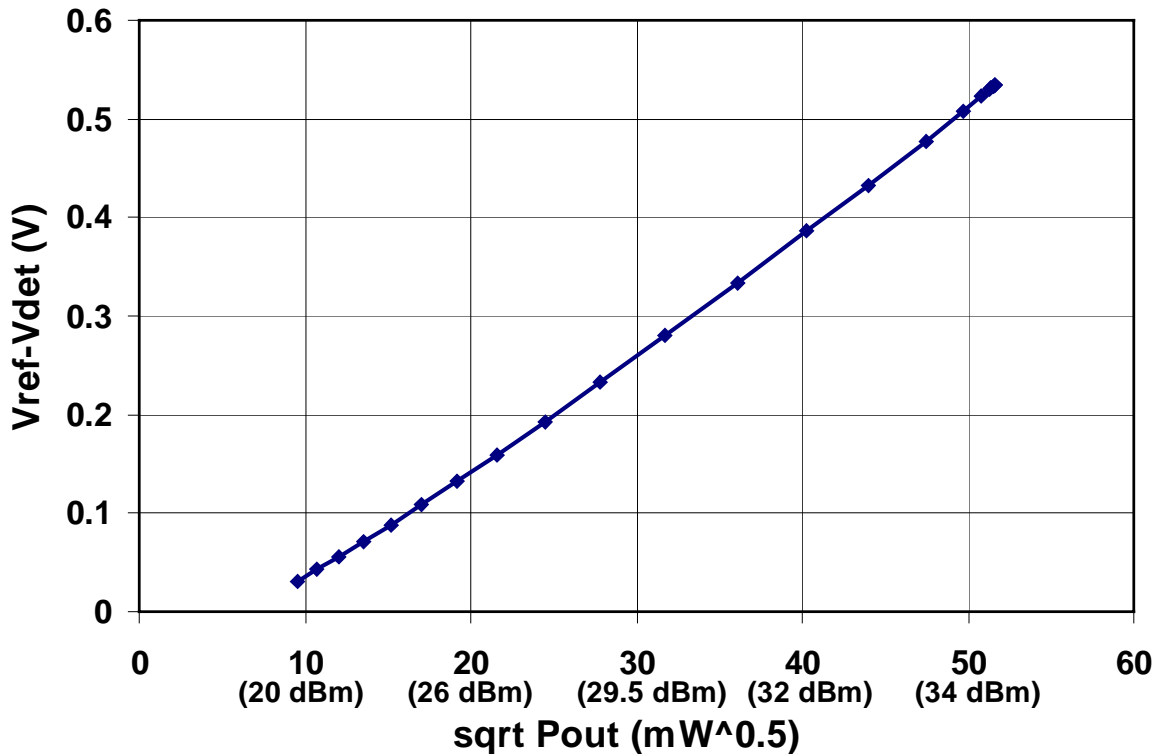

Package Pinout Diagram

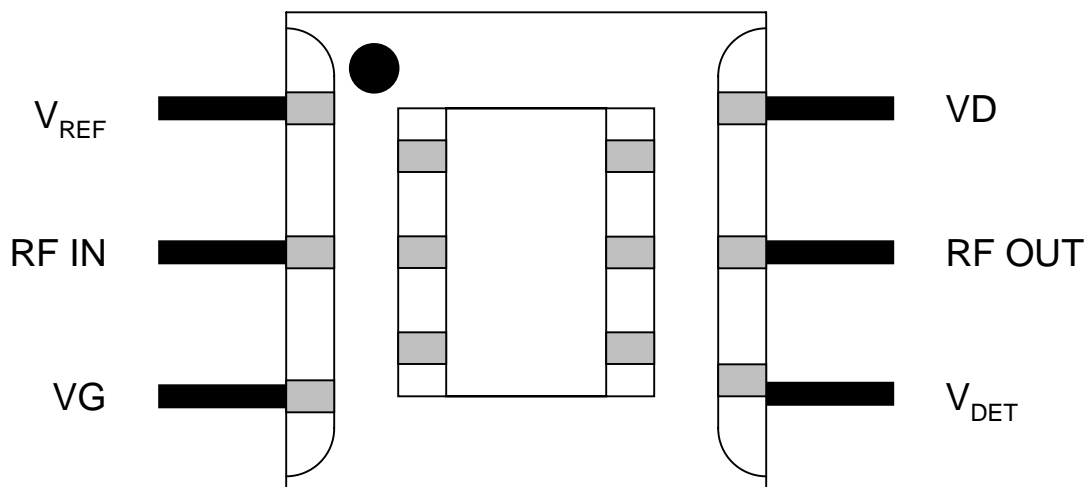

GaAs MMIC devices are susceptible to damage from Electrostatic Discharge. Proper precautions should be observed during handling, assembly and test.

Mechanical Drawing

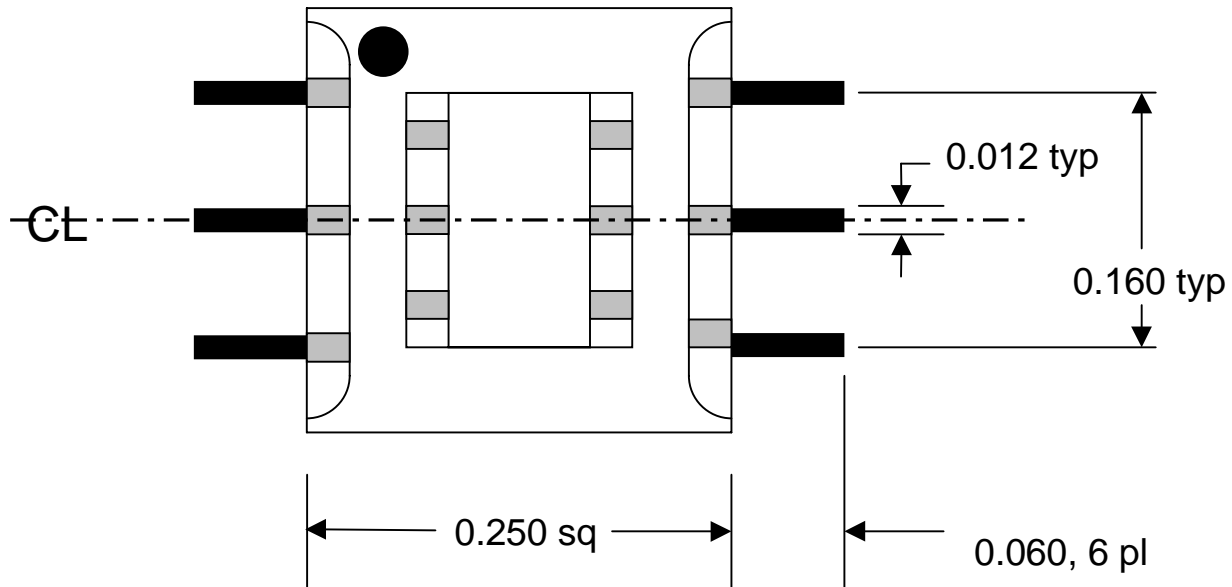

Top View

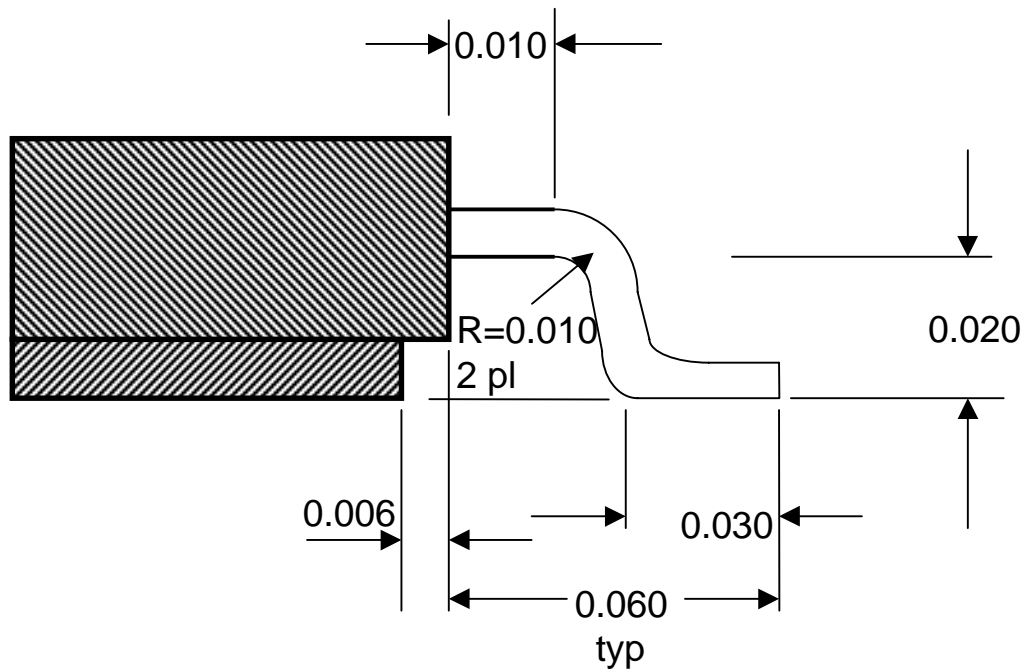

Side View

Dimensions in inches
Lead planarity is +0.006/-0.002

Recommended PWB Land Pattern

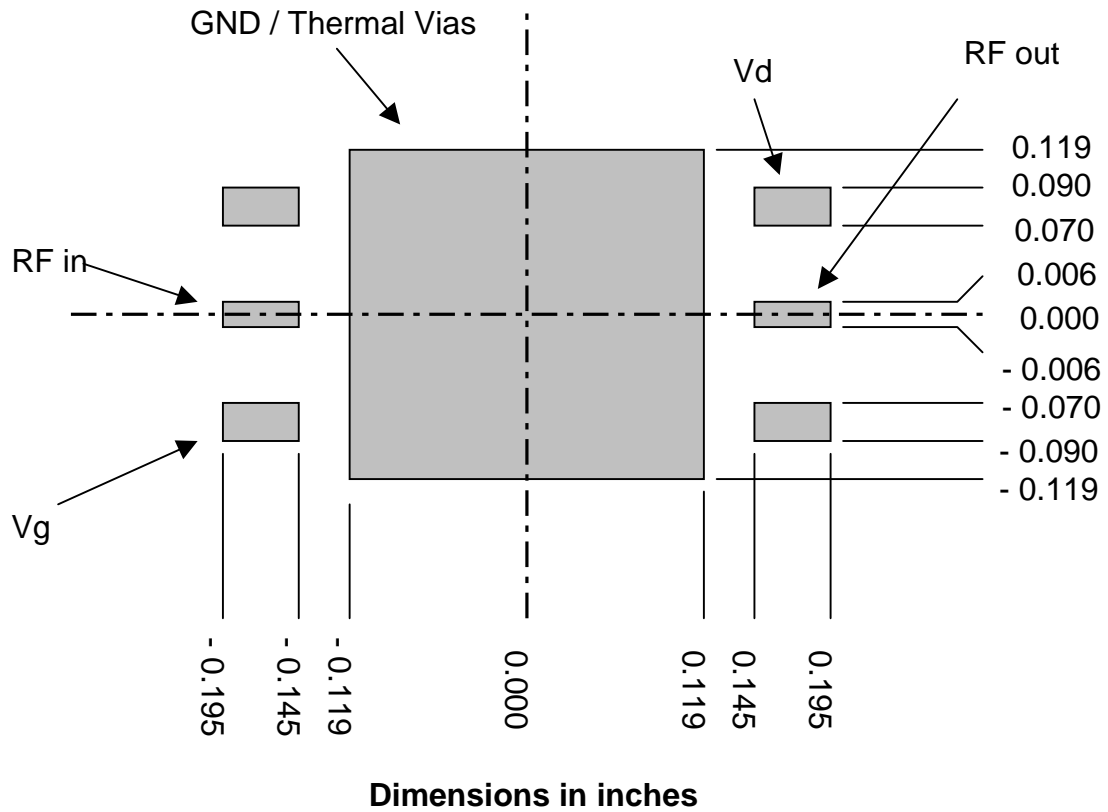

Recommended Surface Mount Package Assembly

Proper ESD precautions must be followed while handling packages.

Clean the board with acetone. Rinse with alcohol. Allow the circuit to fully dry.

TriQuint recommends using a conductive solder paste for attachment. Follow solder paste and reflow oven vendors' recommendations when developing a solder reflow profile. Typical solder reflow profiles are listed in the table below.

Hand soldering is not recommended. Solder paste can be applied using a stencil printer or dot placement. The volume of solder paste depends on PCB and component layout and should be well controlled to ensure consistent mechanical and electrical performance.

Clean the assembly with alcohol.

Typical Solder Reflow Profiles

| Reflow Profile | SnPb | Pb Free |
|--------------------------------------|-----------------------------|-----------------------------|
| Ramp-up Rate | 3 °C/sec | 3 °C/sec |
| Activation Time and Temperature | 60 – 120 sec @ 140 – 160 °C | 60 – 180 sec @ 150 – 200 °C |
| Time above Melting Point | 60 – 150 sec | 60 – 150 sec |
| Max Peak Temperature | 240 °C | 260 °C |
| Time within 5 °C of Peak Temperature | 10 – 20 sec | 10 – 20 sec |
| Ramp-down Rate | 4 – 6 °C/sec | 4 – 6 °C/sec |

Ordering Information

| PART NUMBER | AMPLIFIER APPLICATION |
|------------------|-----------------------|
| TGA2902-1-SCC-SG | Wideband |
| TGA2902-2-SCC-SG | VSAT Band |

Tape & Reel in increments of 500 pcs, specify "T&R" after the part number: TGA2902-1-SCC-SG T&R.

GaAs MMIC devices are susceptible to damage from Electrostatic Discharge. Proper precautions should be observed during handling, assembly and test.