

TGA4512-SM

Ka-Band Driver Amplifier



Applications

- Ka-band VSAT Ground Terminal
- Point-to-Point Radio

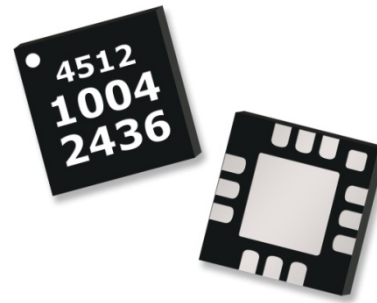

QFN 3x3mm 12L

Product Features

- Frequency Range: 28 – 32 GHz
- Power: 17 dBm Psat, 16 dBm P1dB
- Gain: 14.5 dB
- TOI: 24dBm
- NF: 7.5 dB
- Bias: Vd = 6 V, Id = 80 mA, Vg = -0.45 V Typical
- Package Dimensions: 3.0 x 3.0 x 0.85 mm

Functional Block Diagram

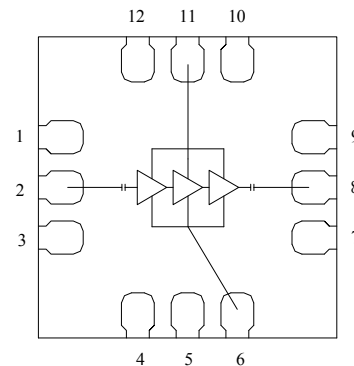

General Description

The TriQuint TGA4512-SM is a Ka-Band Packaged Driver Amplifier. The TGA4512-SM operates from 28-32 GHz and is designed using TriQuint's power pHEMT production process.

The TGA4512-SM typically provides 17 dBm of saturated output power with small signal gain of 14.5 dB.

The TGA4512-SM is available in a low-cost, surface mount 12 lead 3x3 QFN package and is ideally suited for Ka-band VSAT Ground Terminal, and Point-to-Point Radio.

Lead-free and RoHS compliant

Evaluation Boards are available upon request.

Pin Configuration

Pin #	Symbol
1, 3, 4, 5, 7, 9, 10, 12	N/C
2	RF IN
6	Vg
8	RF OUT
11	Vd

Ordering Information

Part No.	ECCN	Description
TGA4512-SM	3A001.b.2.d	Ka-band Driver Amplifier

Standard T/R size = 1000 pieces on a 7" reel.

Specifications

Absolute Maximum Ratings

Parameter	Rating
Drain Voltage, Vd	+8 V
Gate Voltage, Vg	-5 to 0 V
Drain Current, Id	100 mA
Gate Current, Ig	-0.6 to 3.5
Power Dissipation, Pdiss	0.65 W
RF Input Power, CW, 50Ω, T = 25°C	18 dBm
Channel Temperature, Tch	200 °C
Mounting Temperature (30 Seconds)	260 °C
Storage Temperature	-40 to 150

Operation of this device outside the parameter ranges given above may cause permanent damage. These are stress ratings only, and functional operation of the device at these conditions is not implied.

Recommended Operating Conditions

Parameter	Min	Typical	Max	Units
Vd		6		V
Id		80		mA
Id_drive (Under RF Drive)		100		mA
Vg		-0.45		V

Electrical specifications are measured at specified test conditions. Specifications are not guaranteed over all recommended operating conditions.

Electrical Specifications

Test conditions unless otherwise noted: 25°C, Vd = 6 V, Id = 80 mA, Vg = -0.45 V Typical.

Parameter	Min	Typical	Max	Units
Operational Frequency Range	28		32	GHz
Gain	11	14.5		dB
Input Return Loss		-12		dB
Output Return Loss		-10		dB
Output Power @ Saturation	14	17		dBm
Output Power @ 1dB Gain Compression		16		dBm
Output TOI		24		dBm
Noise Figure		7.5		dB
Gain Temperature Coefficient		-0.38		dB/°C
Power Temperature Coefficient		-0.01		dBm/°C

Specifications (cont.)

Thermal and Reliability Information

Parameter	Condition	Rating
Thermal Resistance, θ_{JC} , measured to back of package	Tbase = 85 °C	$\theta_{JC} = 117.5$ °C/W
Channel Temperature (Tch), and Median Lifetime (Tm)	Tbase = 85 °C, Vd = 6 V, Id = 80 mA, P _{diss} = 0.48 W	Tch = 141 °C Tm = 2.2 E+6 Hours
Channel Temperature (Tch), and Median Lifetime (Tm) Under RF Drive	Tbase = 85 °C, Vd = 6 V, Id = 100 mA, P _{out} = 16.9 dBm, P _{diss} = 0.55 W	Tch = 150 °C Tm = 1 E+6 Hours

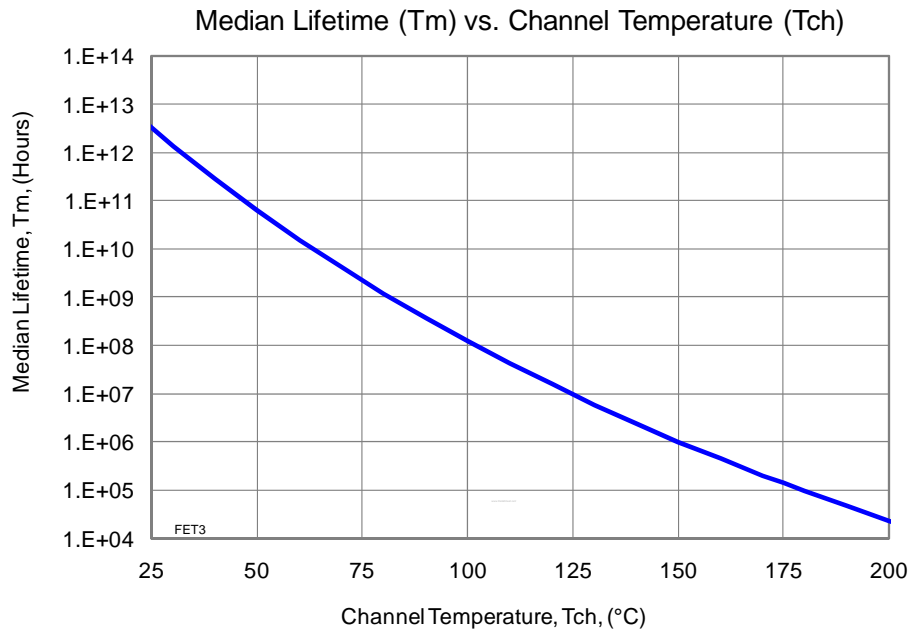

Typical Performance

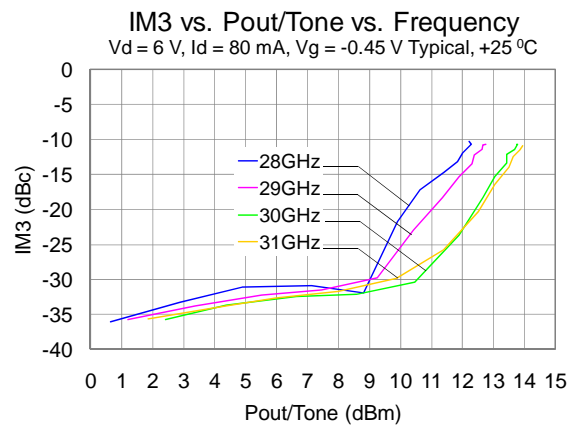
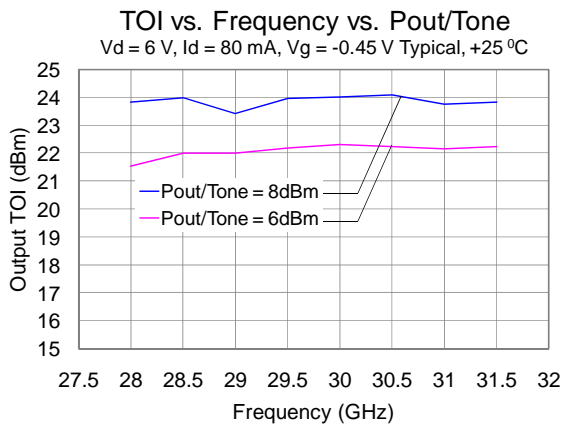
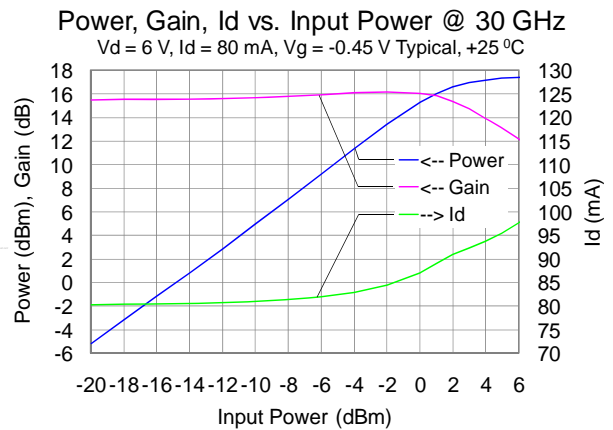
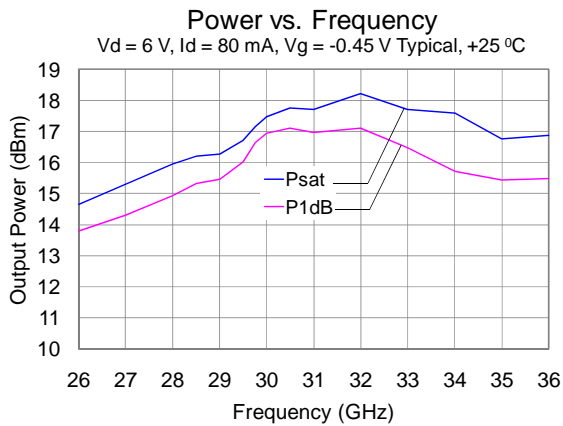
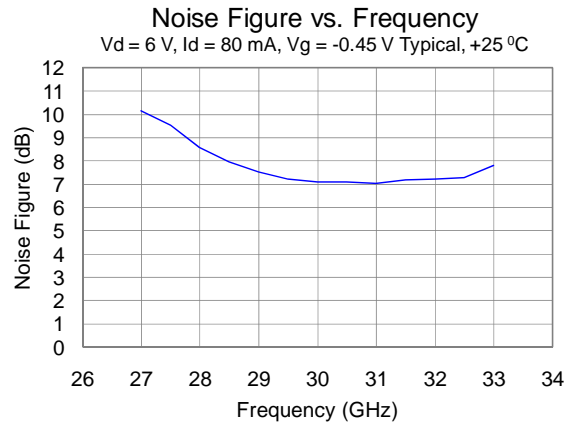
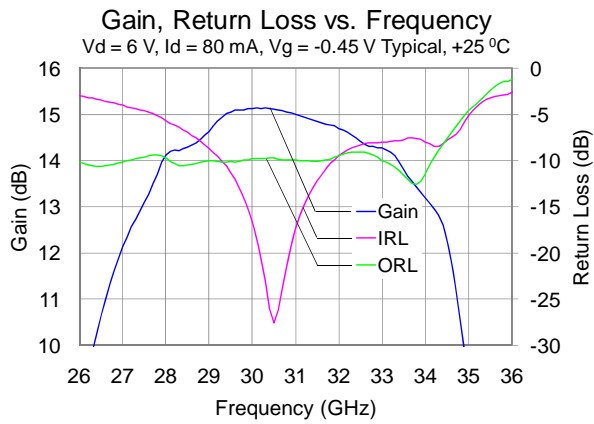

Typical Performance (cont.)

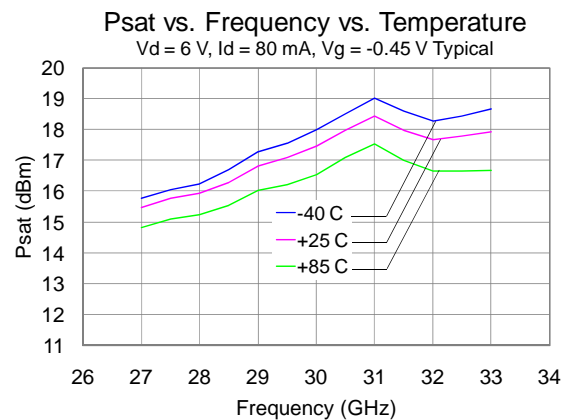
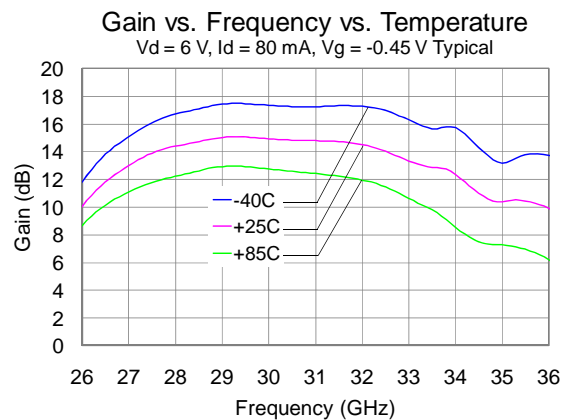
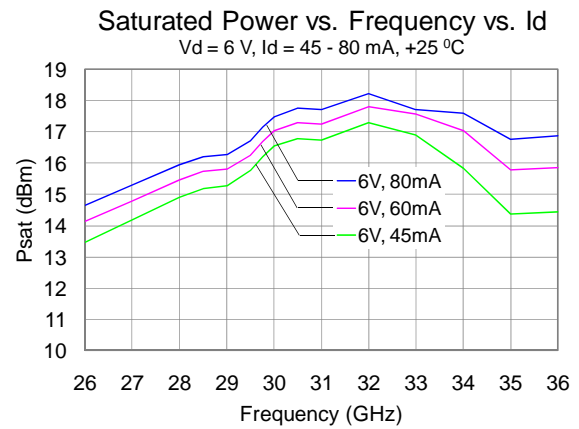
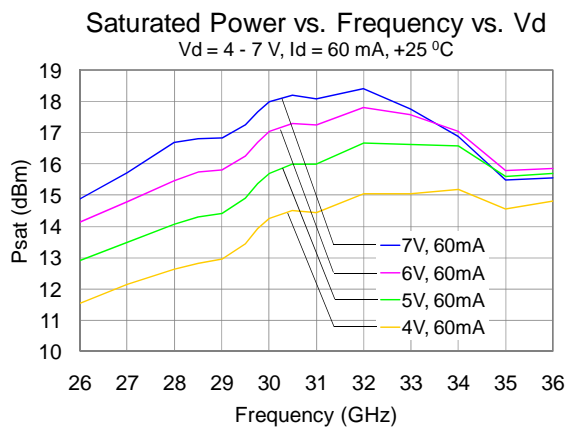
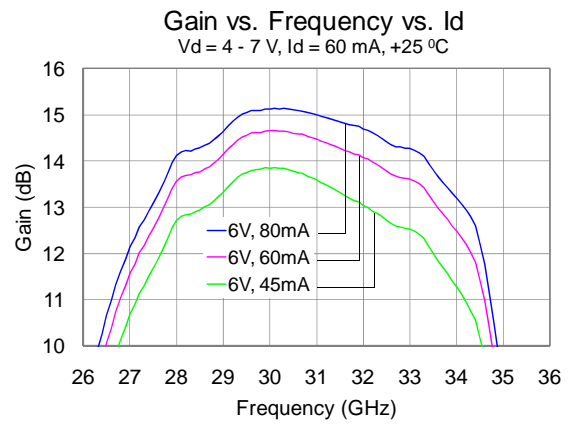
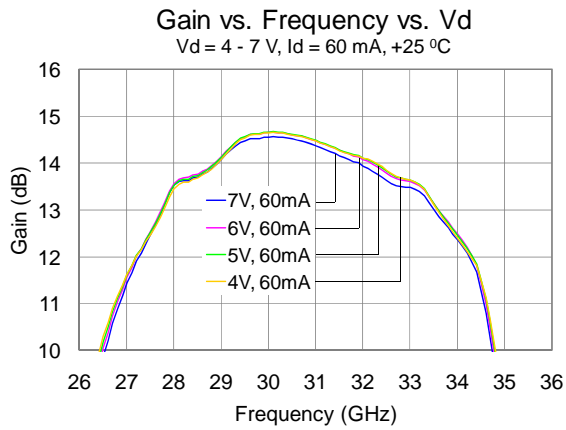

Application Circuit

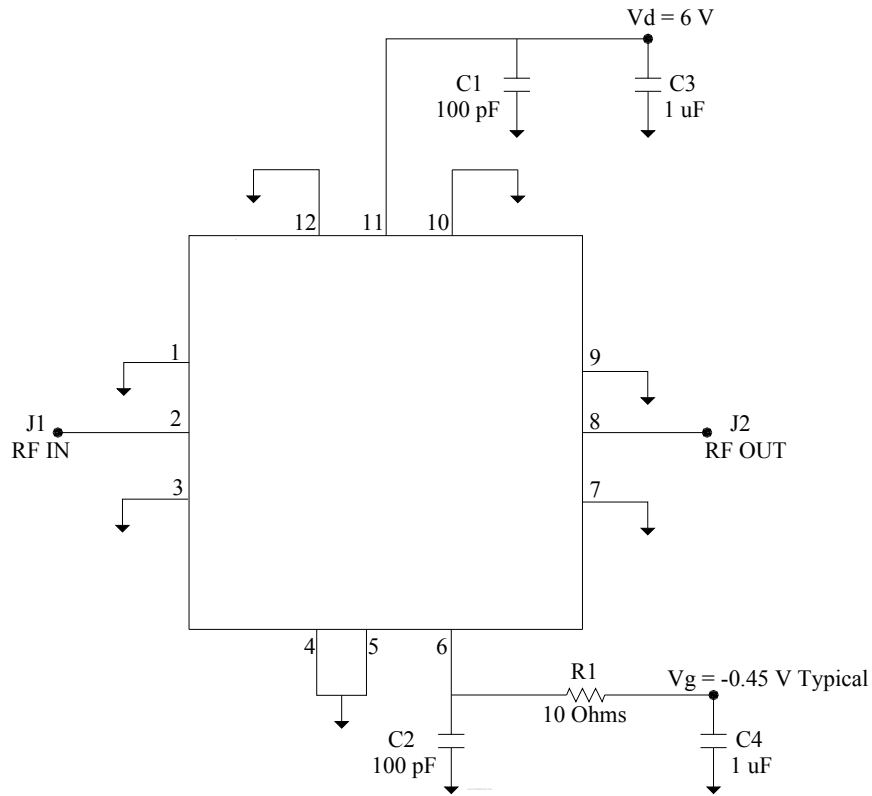

Bias-up Procedure	Bias-down Procedure
Vg set to -1.5 V	Turn off RF supply
Vd set to +6 V	Reduce Vg to -1.5V. Ensure Id ~ 0 mA
Adjust Vg more positive until quiescent Id is 80 mA. This will be ~ Vg = -0.45 V	Turn Vd to 0 V
Apply RF signal to RF Input	Turn Vg to 0 V

Pin Description

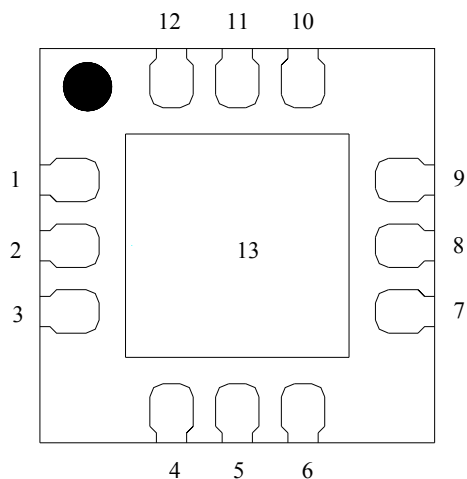

Pin	Symbol	Description
1, 3, 7, 9	N/C	No internal connection; must be grounded on PCB
2	RF IN	Input, matched to 50 ohms
4, 5, 10, 12	N/C	No internal connection. Can be grounded or left open
6	V _g	Gate voltage. Bias network is required; see Application Circuit on page 11 as an example.
8	RF OUT	Output, matched to 50 ohms
11	V _d	Drain voltage. Bias network is required; see Application Circuit on page 11 as an example.
13	GND	Backside Paddle. Multiple vias should be employed to minimize inductance and thermal resistance; see Mounting Configuration on page 15 for suggested footprint.

Applications Information

PC Board Layout

Top RF layer is 0.008” thick Rogers RO4003, $\epsilon_r = 3.38$. Metal layers are 1-oz copper. Microstrip 50 Ω line detail: width = 0.0175”.

The pad pattern shown has been developed and tested for optimized assembly at TriQuint Semiconductor. The PCB land pattern has been developed to accommodate lead and package tolerances. Since surface mount processes vary from company to company, careful process development is recommended.

For further technical information, refer to the [TGA4512-SM](#) Product Information page.

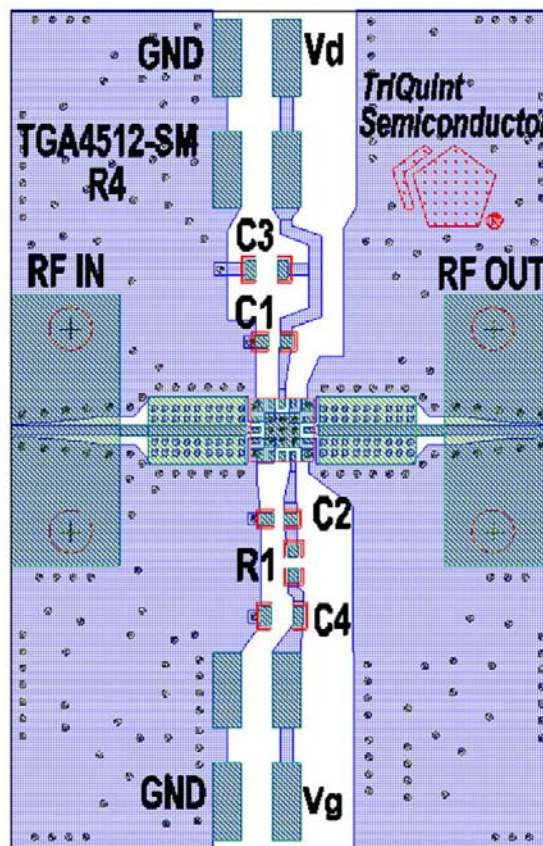
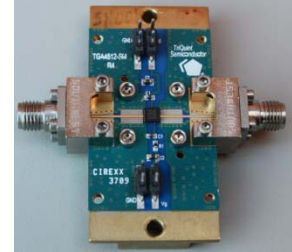

Bill of Material

Ref Des	Value	Description	Manufacturer	Part Number
C1, C2	100 pF	Cap, 0402, 50V, 5%, NPO	various	
C3, C4	1 uF	Cap, 0603, 50V, 5%, NPO	various	
R1	10 Ohms	Res, 0402, 1/16W, 5%, NPO	various	

Mechanical Information

Package Information and Dimensions

All dimensions are in millimeters.

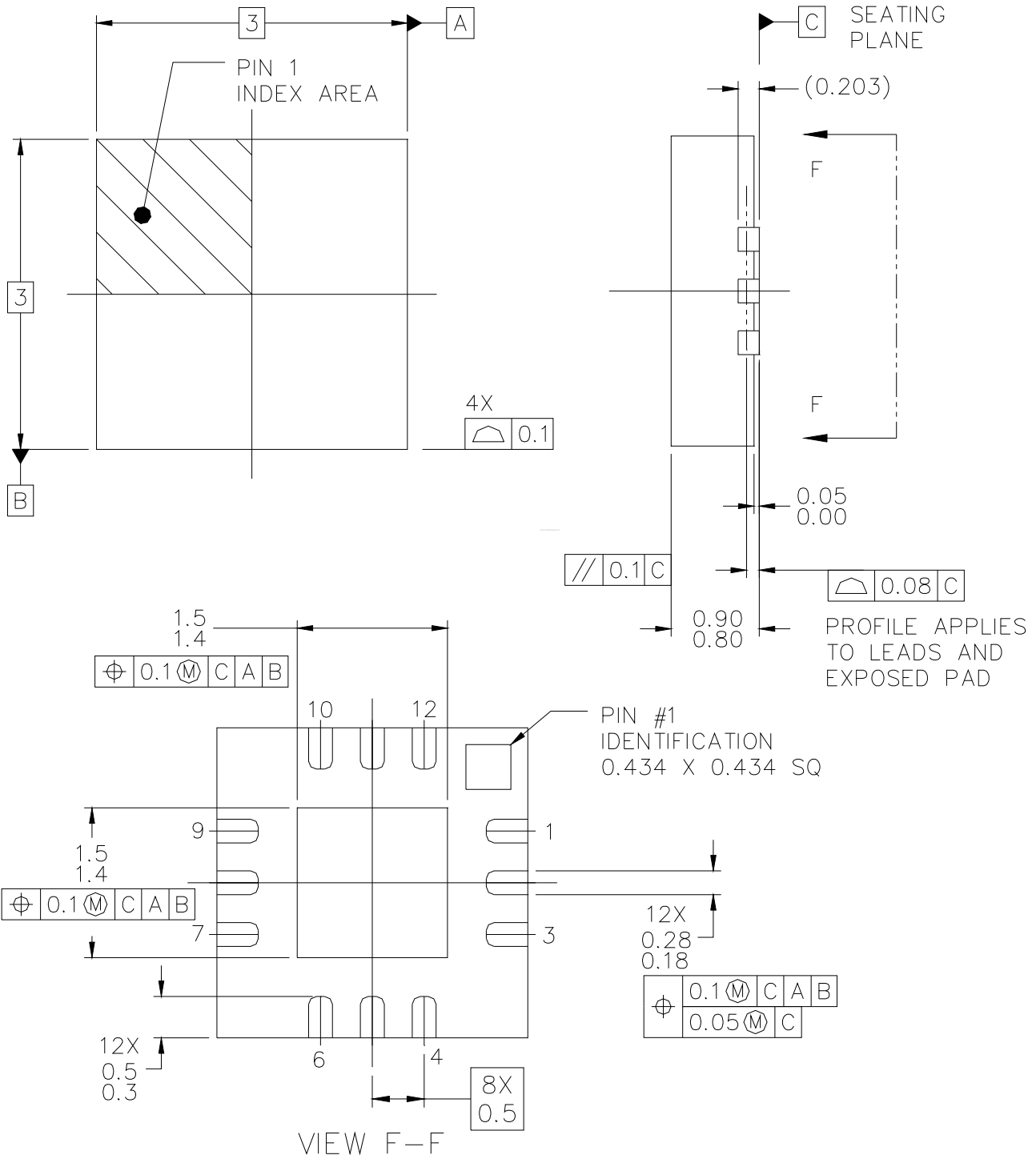

TGA4512-SM

Ka-Band Driver Amplifier

This package is lead-free/RoHS-compliant. The package base is copper alloy and the plating material on the leads is matte tin. It is compatible with both lead-free (maximum 260 °C reflow temperature) and tin-lead (maximum 245 °C reflow temperature) soldering processes.

The TGA4512-SM will be marked with the “4512” designator and a lot code marked below the part designator. The “YY” represents the last two digits of the year the part was manufactured, the “WW” is the work week, and the “XXXX” is an auto-generated number.

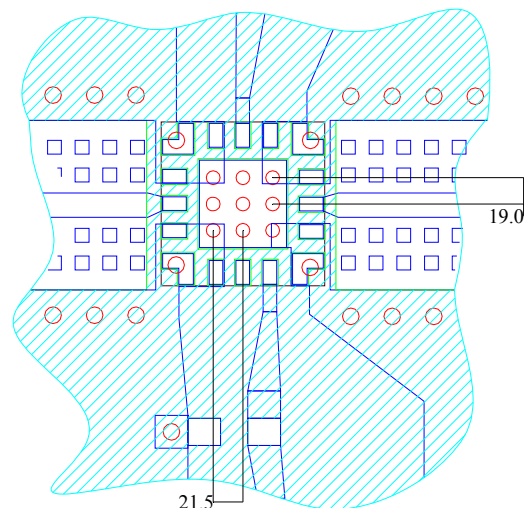

Mechanical Information (cont.)

Mounting Configuration

All dimensions are in millimeters (inches).

Notes:

1. A heatsink underneath the area of the PCB for the mounted device is recommended for proper thermal operation.
2. Ground / thermal vias are critical for the proper performance of this device. Vias have a final plated thru diameter of .25 mm (.010”).

Tape and Reel Information

Tape and reel specifications for this part are also available on the TriQuint website in the “Application Notes” section.
Standard T/R size = 1000 pieces on a 7 x 0.5” reel.

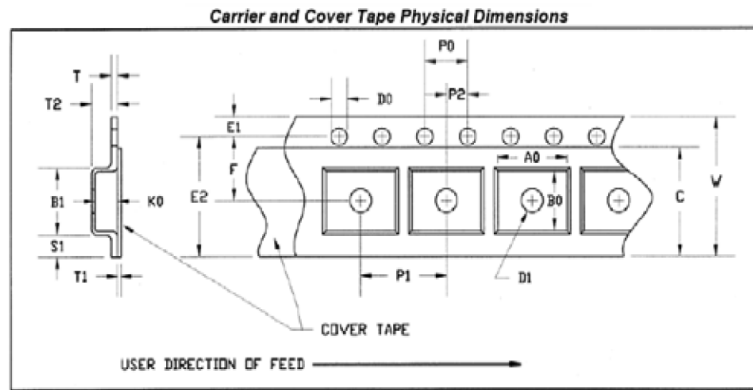

CARRIER AND COVER TAPE DIMENSIONS

Part	Feature	Symbol	Size (in)	Size (mm)
Cavity	Length	A0	0.130	3.3
	Width	B0	0.130	3.3
	Depth	K0	0.043	1.1
	Pitch	P1	0.315	8.0
Distance Between Centerline	Cavity to Perforation Length Direction	P2	0.079	2.0
	Cavity to Perforation Width Direction	F	0.217	5.5
Cover Tape	Width	C	0.362	9.2
Carrier Tape	Width	W	0.472	12.0

Product Compliance Information

ESD Information



Caution! ESD-Sensitive Device

ESD Rating: TBD

Value: Passes \geq TBD min.

Test: Human Body Model (HBM)

Standard: JEDEC Standard JESD22-A114

MSL Rating

Level TBD at +260 °C convection reflow

The part is rated Moisture Sensitivity Level TBD at 260°C per JEDEC standard IPC/JEDEC J-STD-020.

ECCN

US Department of Commerce 3A001.b.2.d

Solderability

Compatible with the latest version of J-STD-020, Lead free solder, 260°

This part is compliant with EU 2002/95/EC RoHS directive (Restrictions on the Use of Certain Hazardous Substances in Electrical and Electronic Equipment).

This product also has the following attributes:

- Lead Free
- Halogen Free (Chlorine, Bromine)
- Antimony Free
- TBBP-A (C₁₅H₁₂Br₄O₂) Free
- PFOS Free
- SVHC Free

Recommended Soldering Temperature Profile

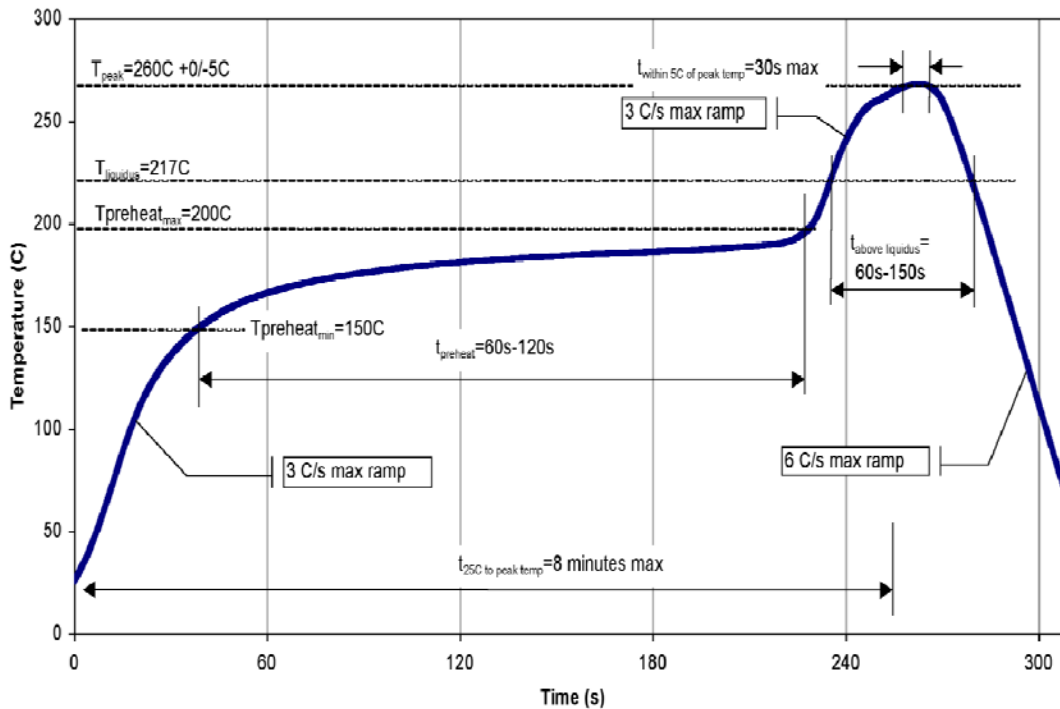

Contact Information

For the latest specifications, additional product information, worldwide sales and distribution locations, and information about TriQuint:

Web: www.triquint.com
Email: info-sales@tqs.com

Tel: +1.972.994.8465
Fax: +1.972.994.8504

For technical questions and application information:

Email: info-networks@tqs.com

Important Notice

The information contained herein is believed to be reliable. TriQuint makes no warranties regarding the information contained herein. TriQuint assumes no responsibility or liability whatsoever for any of the information contained herein. TriQuint assumes no responsibility or liability whatsoever for the use of the information contained herein. The information contained herein is provided "AS IS, WHERE IS" and with all faults, and the entire risk associated with such information is entirely with the user. All information contained herein is subject to change without notice. Customers should obtain and verify the latest relevant information before placing orders for TriQuint products. The information contained herein or any use of such information does not grant, explicitly or implicitly, to any party any patent rights, licenses, or any other intellectual property rights, whether with regard to such information itself or anything described by such information.

TGA4512-SM

Ka-Band Driver Amplifier



TriQuint products are not warranted or authorized for use as critical components in medical, life-saving, or life-sustaining applications, or other applications where a failure would reasonably be expected to cause severe personal injury or death.

Copyright © 2012 TriQuint Semiconductor, Inc. All rights reserved.