

### Product Description

The Qorvo TGA4536-SM is a K-Band Power Amplifier with integrated power detector. The TGA4536-SM operates from 24.2 – 26.5 GHz and is designed using Qorvo’s power pHEMT production process.

The TGA4536-SM typically provides 34 dBm of saturated output power with small signal gain of 18 dB. Third Order Intercept is 43 dBm at 23 dBm SCL.

The TGA4536-SM is available in a low-cost, surface mount 28 lead 5x5 mm QFN package and is ideally suited for Point-to-Point Radio.

Lead-free and RoHS compliant



28 lead 5x5mm QFN package

### Product Features

- Frequency Range: 24.2 – 26.5 GHz
- Power: 34 dBm Psat, 33 dBm P1dB
- Gain: 18 dB
- TOI: 43 dBm at 23 dBm/tone
- Integrated Power Detector
- Bias:  $V_d = 6\text{ V}$ ,  $I_{dq} = 1430\text{ mA}$ ,  $V_g = -0.7\text{ V}$  Typical
- Package Dimensions: 5.0 x 5.0 x 1.3 mm

*Performance is typical across frequency. Please reference electrical specification table and data plots for more details.*

### Applications

- Point- to - Point Radio
- K-band Sat-Com

### Functional Block Diagram

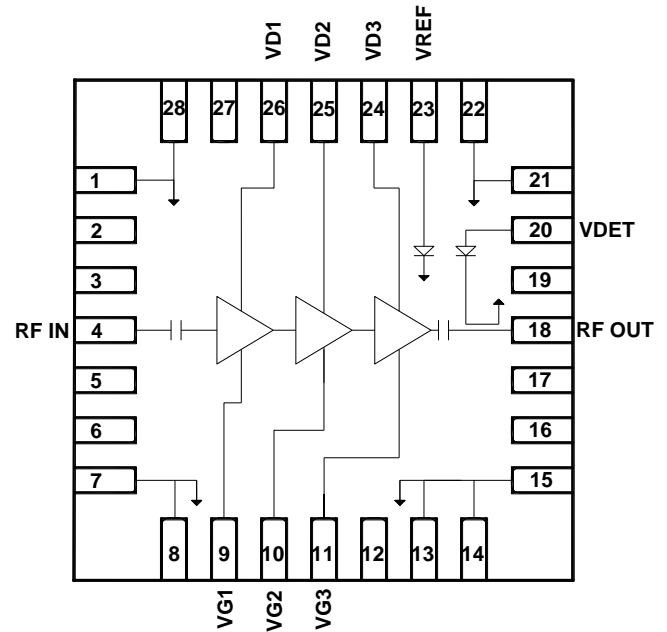

### Ordering Information

Part	Description
TGA4536-SM	Waffle Tray
TGA4536-SM-T/R	500 pieces on a 7" reel (standard)
TGA4536-SM EVB	Evaluation Board

### Absolute Maximum Ratings

Parameter	Value
Drain to Gate Voltage, $V_D - V_G$	10 V
Drain Voltage ( $V_D$ )	6.5 V
Drain Current ( $I_D$ )	3.0 A
Gate Voltage Range ( $V_G$ )	-3 to 0 V
Gate Current ( $I_G$ )	-14 to 110 mA
Power Dissipation, $P_{DISS}$	20 W
RF Input Power, CW, $T = 25\text{ }^\circ\text{C}$	25 dBm
Channel Temperature, $T_{CH}$	200 $^\circ\text{C}$
Mounting Temperature (30 seconds)	260 $^\circ\text{C}$
Storage Temperature	-40 to 150 $^\circ\text{C}$

Operation of this device outside the parameter ranges given above may cause permanent damage. These are stress ratings only, and functional operation of the device at these conditions is not implied.

### Recommended Operating Conditions

Parameter	Value
Drain Voltage	6 V
Drain Current (quiescent, $I_{DQ}$ )	1430 mA
Drain Current ( $I_{DD}$ @ P1dB)	2000 mA
Gate Voltage (typical)	-0.7 V
Gate Current ( $I_{GD}$ Under RF Drive)	25 mA
Operating Temperature Range	-40 to 85 $^\circ\text{C}$

Electrical specifications are measured at specified test conditions. Specifications are not guaranteed over all recommended operating conditions.

### Electrical Specifications

Test conditions, unless otherwise noted: 25  $^\circ\text{C}$ ,  $V_D = 6\text{ V}$ ,  $I_{DQ} = 1430\text{ mA}$ ,  $V_G = -0.7\text{ V}$  typical,  $Z_0 = 50\text{ }\Omega$

Parameter	Min	Typical	Max	Units
Frequency	24.2		26.5	GHz
Small Signal Gain		18		dB
Input Return Loss		9		dB
Output Return Loss		10		dB
Output Power @ Saturation		34		dBm
Output Power @ 1 dB Gain Compression		33		dBm
Output TOI @ 23 dBm/Tone Pout/tone		43		dBm
Gain Temperature Coefficient		-0.02		dBm/ $^\circ\text{C}$
Power Temperature Coefficient		-0.005		dBm/ $^\circ\text{C}$

### Performance Plots

Test conditions unless otherwise noted: Temp. = 25 °C,  $V_D = 6$  V,  $I_{DQ} = 1430$  mA,  $V_G = -0.7$  V typical

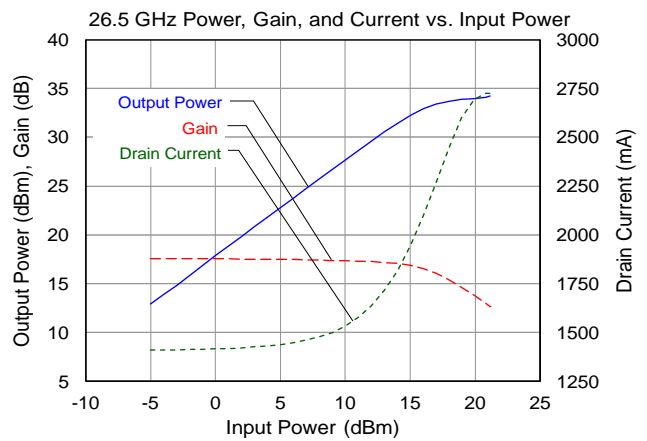
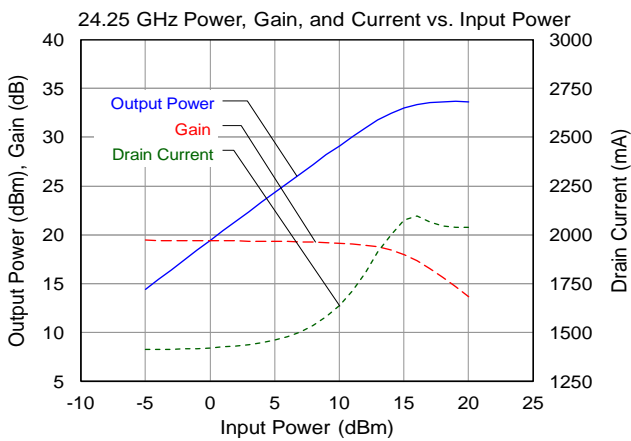
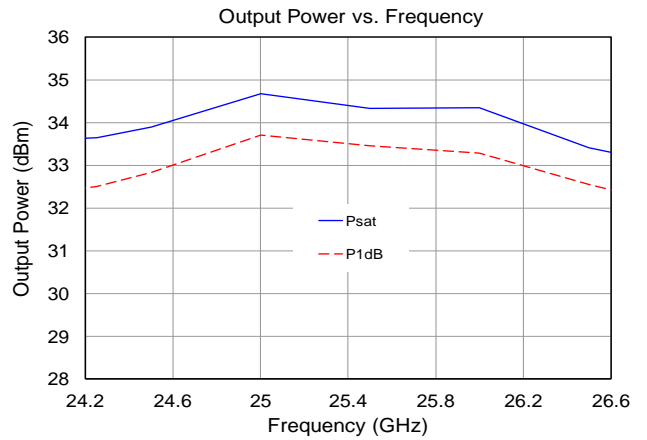
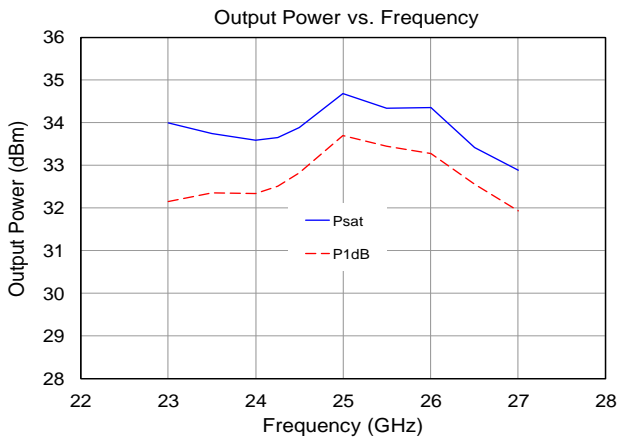
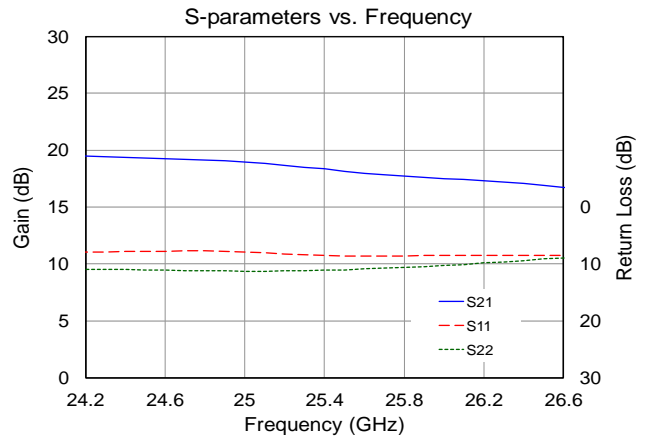
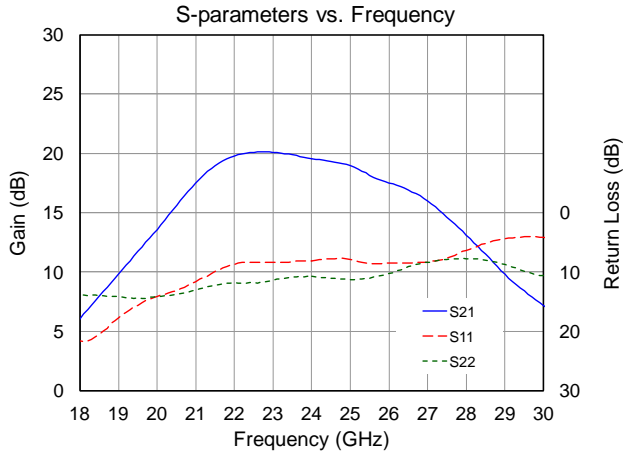

### Performance Plots

Test conditions unless otherwise noted: Temp. = 25 °C,  $V_D = 6$  V,  $I_{DQ} = 1430$  mA,  $V_G = -0.7$  V typical

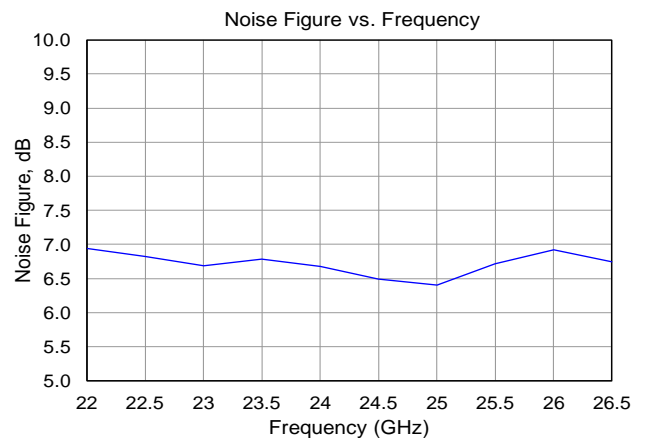
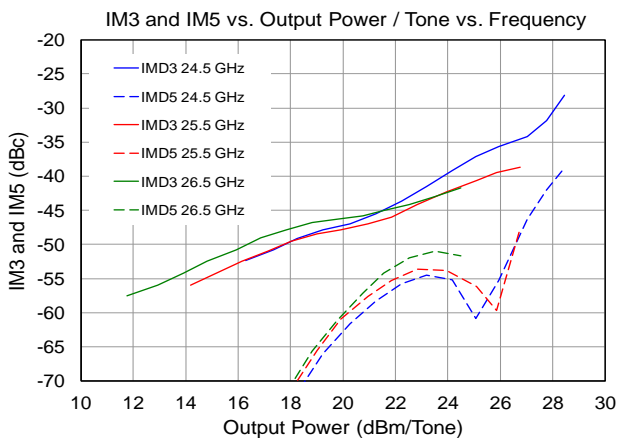
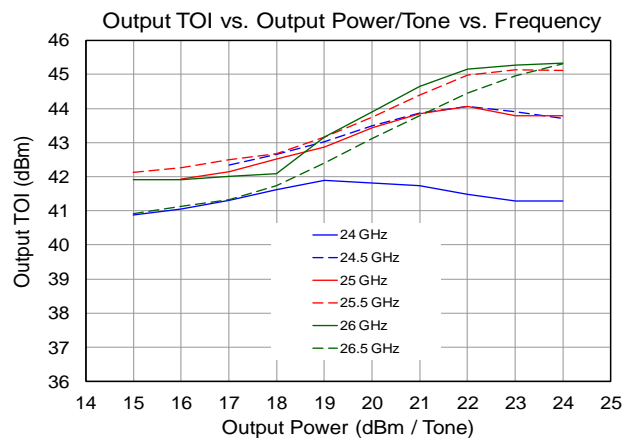
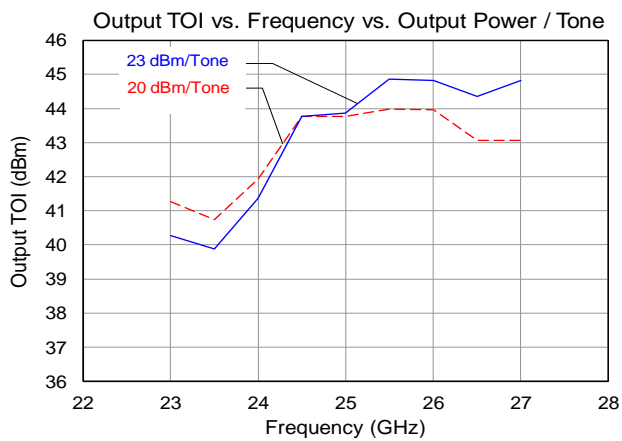
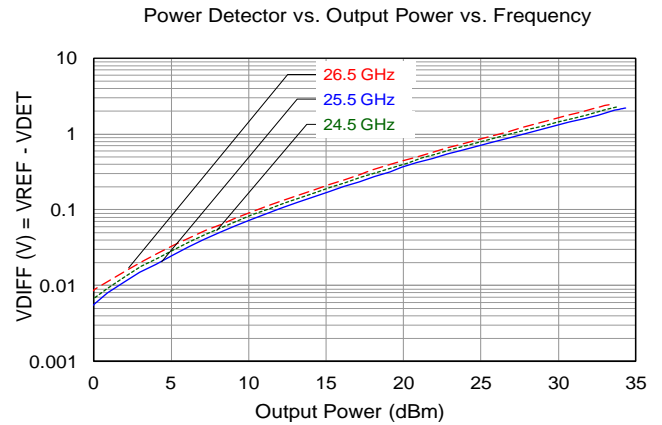
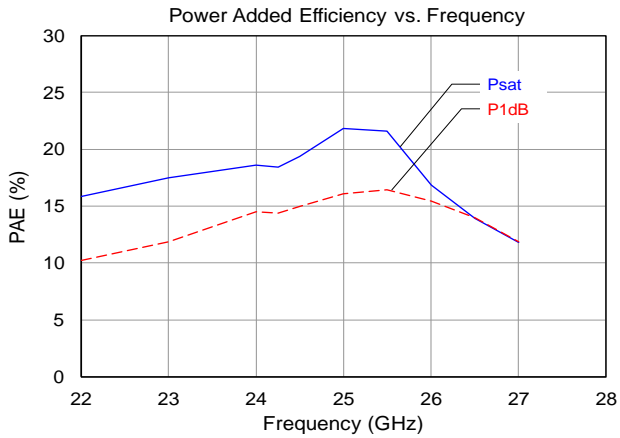

### Performance Plots

Test conditions unless otherwise noted: Temp. = 25 °C,  $V_D = 6\text{ V}$ ,  $I_{DQ} = 1430\text{ mA}$ ,  $V_G = -0.7\text{ V}$  typical

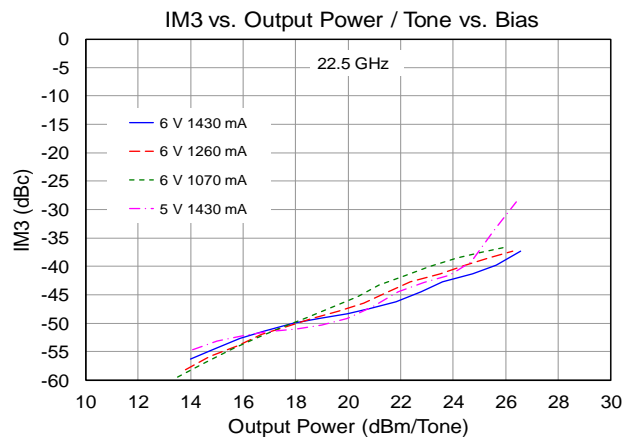
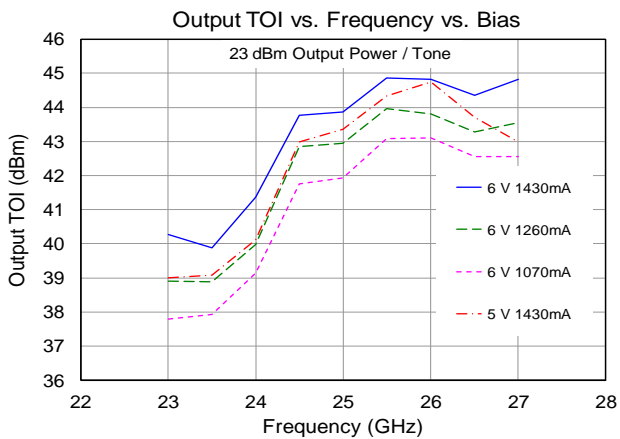
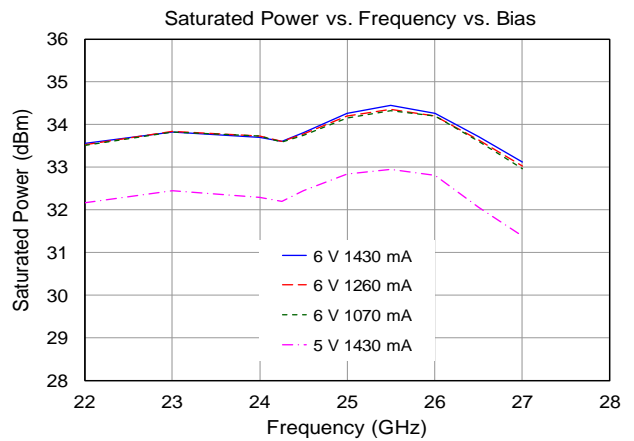
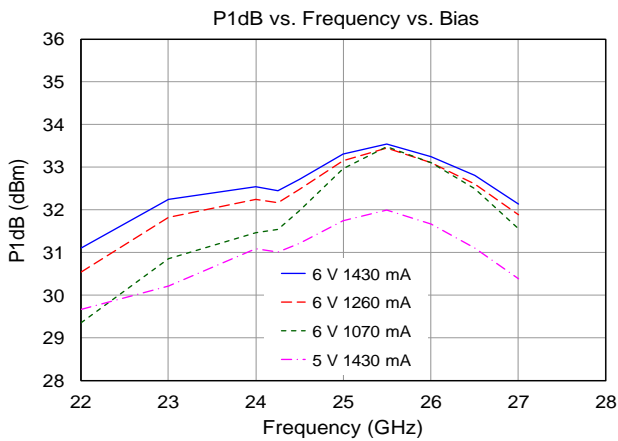
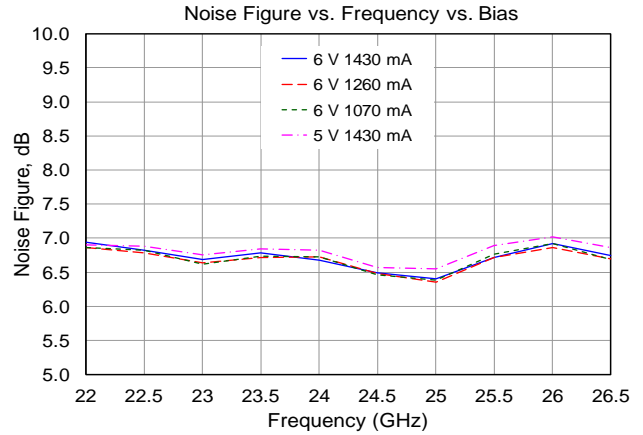
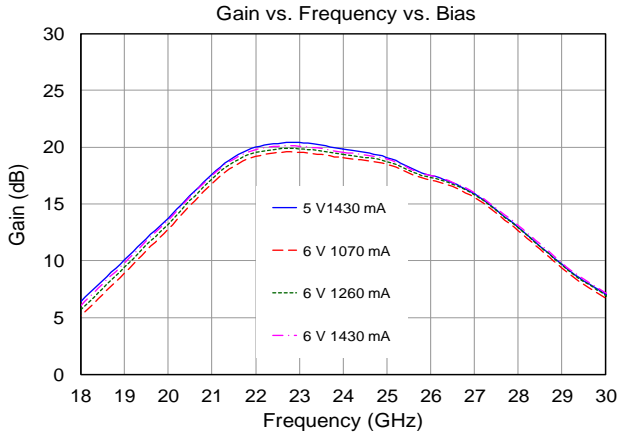

### Performance Plots

Test conditions unless otherwise noted: Temp. = 25 °C,  $V_D = 6\text{ V}$ ,  $I_{DQ} = 1430\text{ mA}$ ,  $V_G = -0.7\text{ V}$  typical

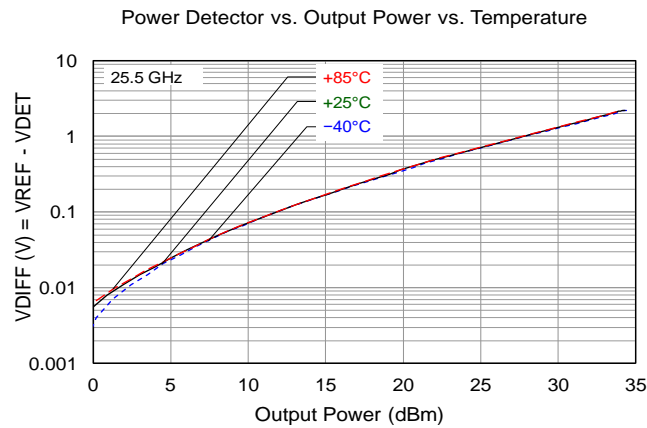
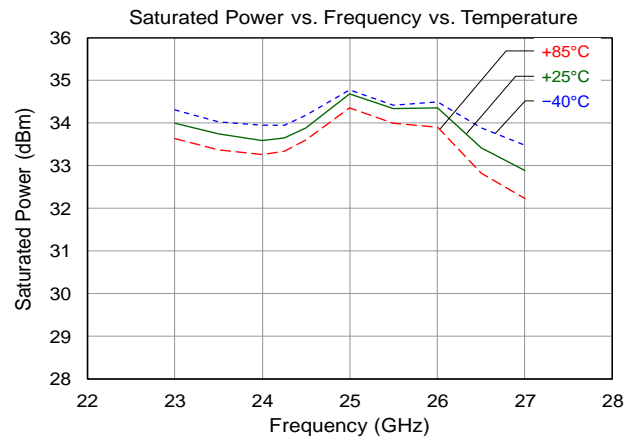
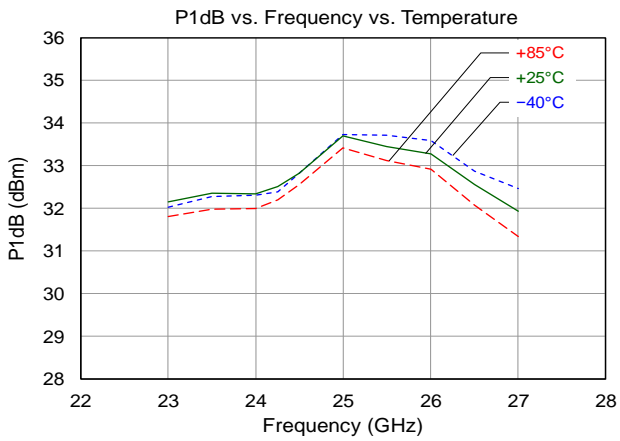
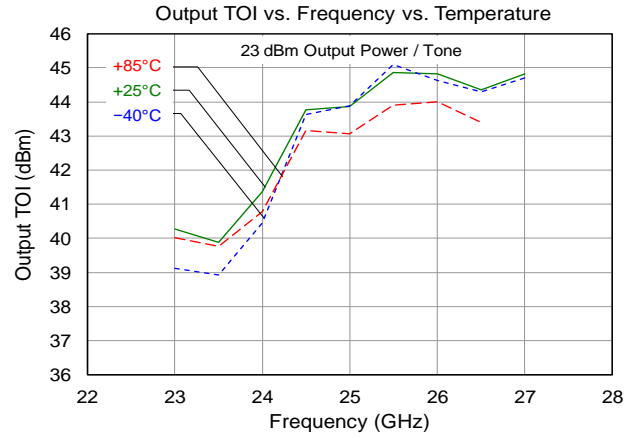
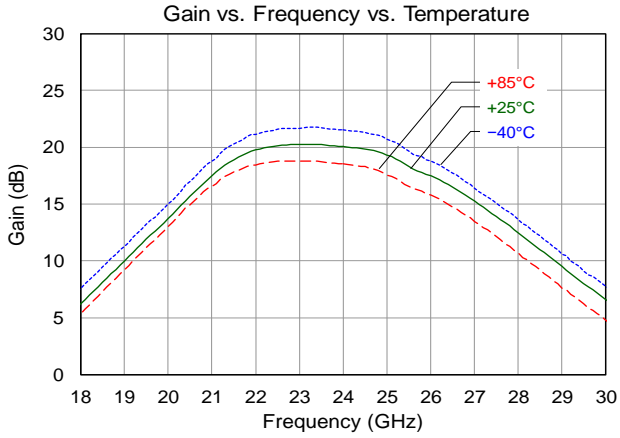

## Pin Configuration and Description

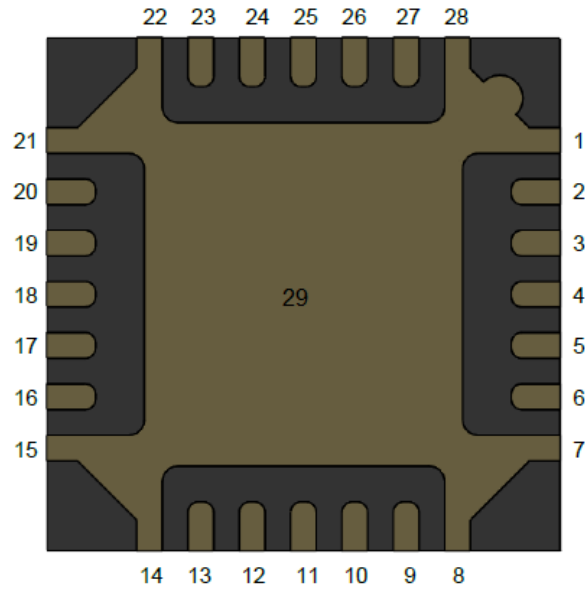

Pin No.	Label	Description
1,7,8,14,15,21,22,28,29	GND	Backside paddle. Multiple vias should be employed to minimize inductance and thermal resistance; see 'PCB Mounting Pattern' on page 10 for suggested footprint
2,3,5,6,16,17,19	N/C	No internal connection; Recommend grounding these pins for best RF performance. See 'PCB Mounting Pattern' on page 10 for suggested footprint
4	RF IN	RF input, matched to 50 ohms
9	VG1	Stage 1 gate voltage <sup>(1)</sup>
10	VG2	Stage 2 gate voltage <sup>(1)</sup>
11	VG3	Stage 3 gate voltage <sup>(1)</sup>
12, 27	N/C	No internal connection; May be grounded on PCB or left open
13	GND	Internally connected to GND. May be grounded on the PCB or left open
18	RF OUT	RF output, matched to 50 ohms
20	VDET	Detector diode output voltage. Varies with RF output power
23	VREF	Reference diode output voltage
24	VD3	Stage 3 drain voltage <sup>(1)</sup>
25	VD2	Stage 2 drain voltage <sup>(1)</sup>
26	VD1	Stage 1 drain voltage <sup>(1)</sup>

(1) Bias bypass network is required; see 'Application Circuit' on page 8 as an example

### Applications Circuit

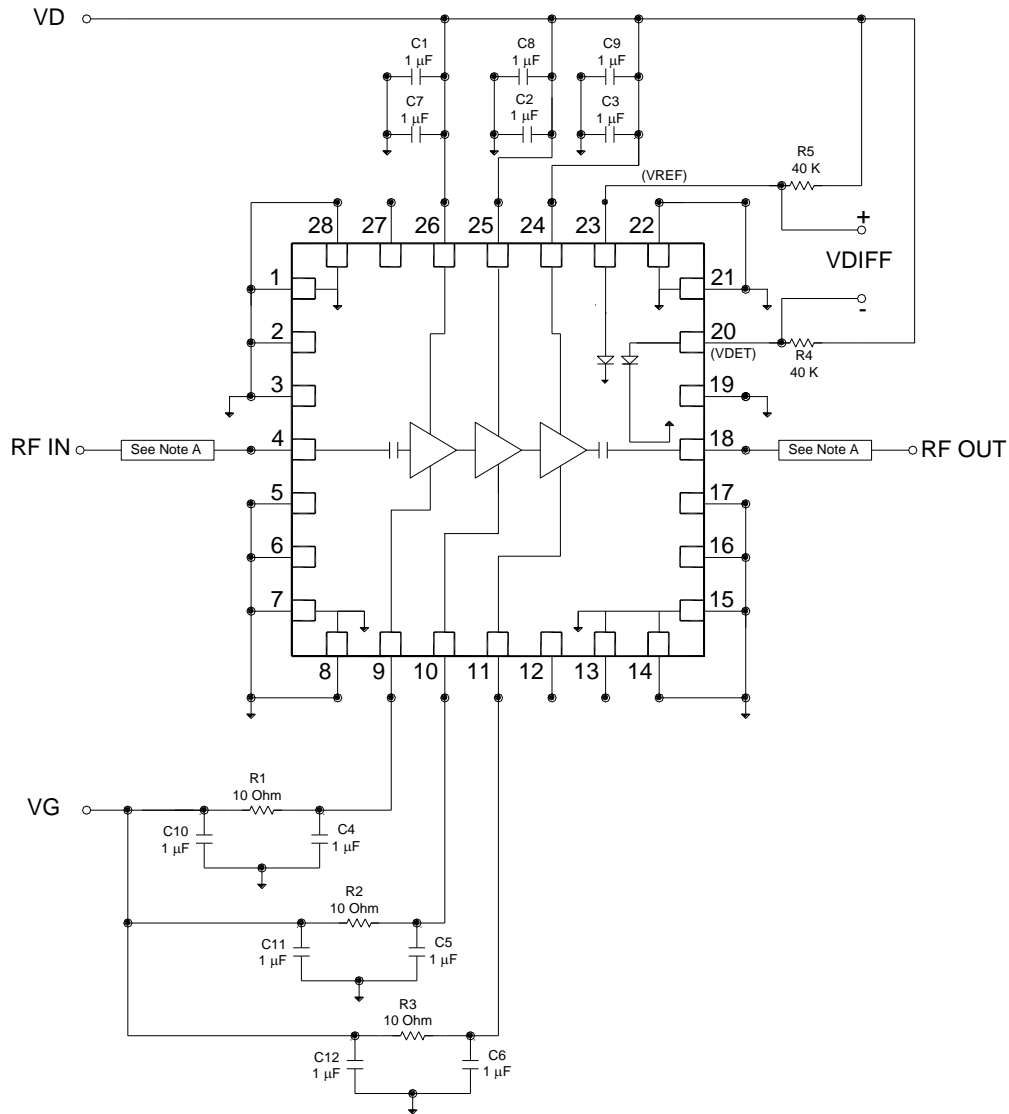

Note A: 50  $\Omega$  Microstrip Transmission Line.

### Bias Up Procedure

1. Set  $I_D$  limit to 2800 mA,  $I_G$  limit to 60 mA
2. Set  $V_G$  to  $-1.5$  V
3. Set  $V_D$  +6 V
4. Adjust  $V_G$  more positive until  $I_{DQ} = 1430$ mA  
( $V_G \sim -0.7$  V Typical)
5. Apply RF signal

### Bias Down Procedure

1. Turn off RF signal
2. Reduce  $V_G$  to  $-1.5$  V. Ensure  $I_{DQ} \sim 0$ mA
3. Set  $V_D$  to 0V
4. Turn off  $V_D$  supply
5. Turn off  $V_G$  supply



Evaluation Board Layout

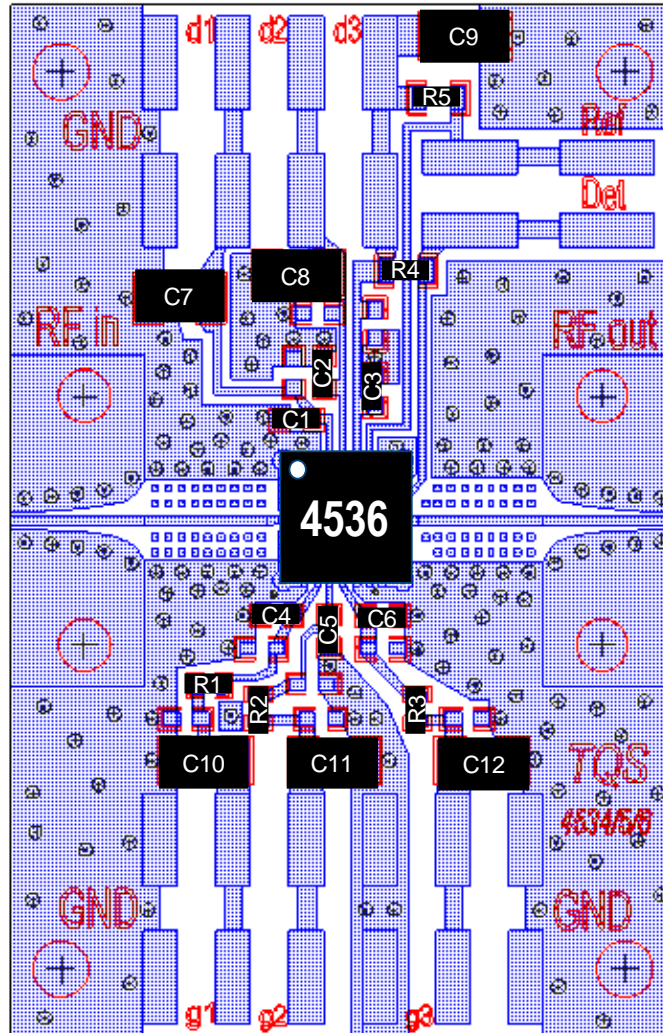

Board material is Rogers Corp. 4003 0.008" thickness with ½ oz copper cladding.  
For further technical information, refer to the [TGA4536-SM](#) Product Information page.

**Bill of Material**

Ref. Des.	Value	Description	Manuf.	Part Number
U1		K Band Power Amplifier	Qorvo	TGA4536-SM
C1 thru C6	1.0 µF	Cap, 0402, 25 V, 10%, X5R SMD	Various	
C7 thru C12	1.0 µF	Cap, 0805, 25 V, 10%, X5R SMD	Various	
R1, R2, R3	10 Ω	Res, 0402, 0.06 W, 5%, SMD	Various	
R4, R5	40 kΩ	Res, 0402, 0.06 W, 5%, SMD	Various	

### Package Marking & Dimensions

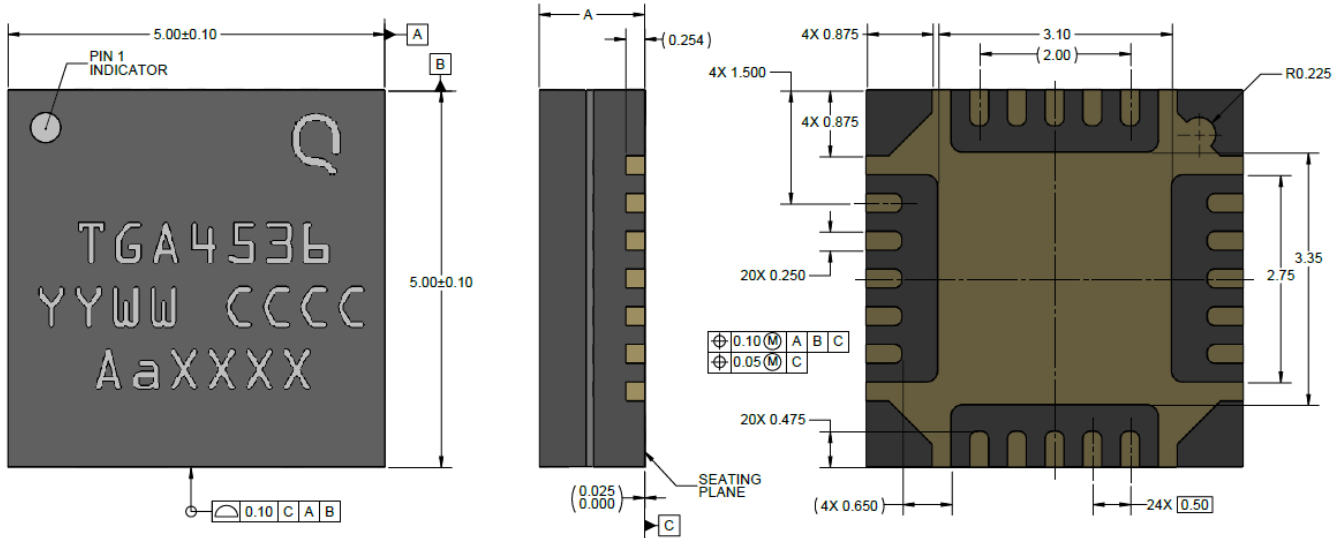

#### LASER MARK NOTES:

- YY IS THE LAST TWO DIGITS OF THE CALENDAR YEAR AND WW IS THE WEEK NUMBER OF THE ASSEMBLY LOT START.
- CCCC IS COUNTRY CODE.
- Aa IS VENDOR (AC).
- XXXX IS THE BATCH ID.

NOTES: UNLESS OTHERWISE SPECIFIED;  
1. PACKAGE LEADS ARE GOLD PLATED.

### PCB Mounting Pattern

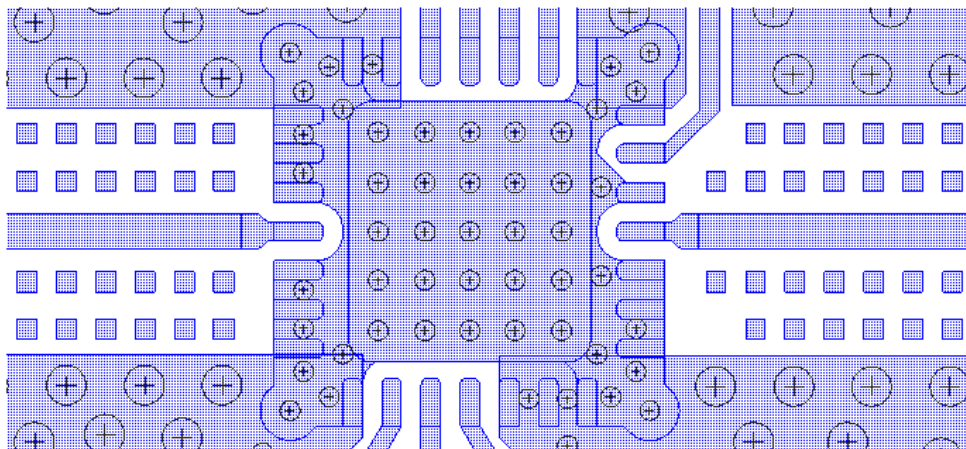

#### Notes:

1. The pad pattern shown has been developed and tested for optimized assembly at Qorvo. The PCB land pattern has been developed to accommodate lead and package tolerances. Since surface mount processes vary from company to company, careful process development is recommended.
2. Ground vias are critical for the proper performance of this device. Vias have a final plated thru diameter of .25 mm (.010").

## Thermal and Reliability Information

Parameter	Test Conditions	Value	Units
Thermal Resistance ( $\theta_{JC}$ ) <sup>(1)</sup>	$T_{base} = 85^{\circ}C$ , $V_D = 6 V$ , $I_{DQ} = 1430 mA$ $P_{DISS} = 8.6 W$	5.75	$^{\circ}C/W$
Channel Temperature ( $T_{CH}$ ) (No RF Drive)		134	$^{\circ}C$
Median Lifetime ( $T_M$ )		6.6E+6	Hrs
Thermal Resistance ( $\theta_{JC}$ ) <sup>(1)</sup>	$T_{base} = 85^{\circ}C$ $V_D = 6 V$ , $I_{DD} = 2100 mA$ $P_{OUT} = 34.2 dBm$ , $P_{DISS} = 10 W$	5.75	$^{\circ}C/W$
Channel Temperature ( $T_{CH}$ ) (Under RF Drive)		143	$^{\circ}C$
Median Lifetime ( $T_M$ )		2.4E+6	Hrs

Notes:

- Thermal resistance is measured to back of the package.

## Median Lifetime

Test Conditions:  $V_D = 6 V$   
 Failure Criteria = 10% reduction in  $I_{D\_MAX}$

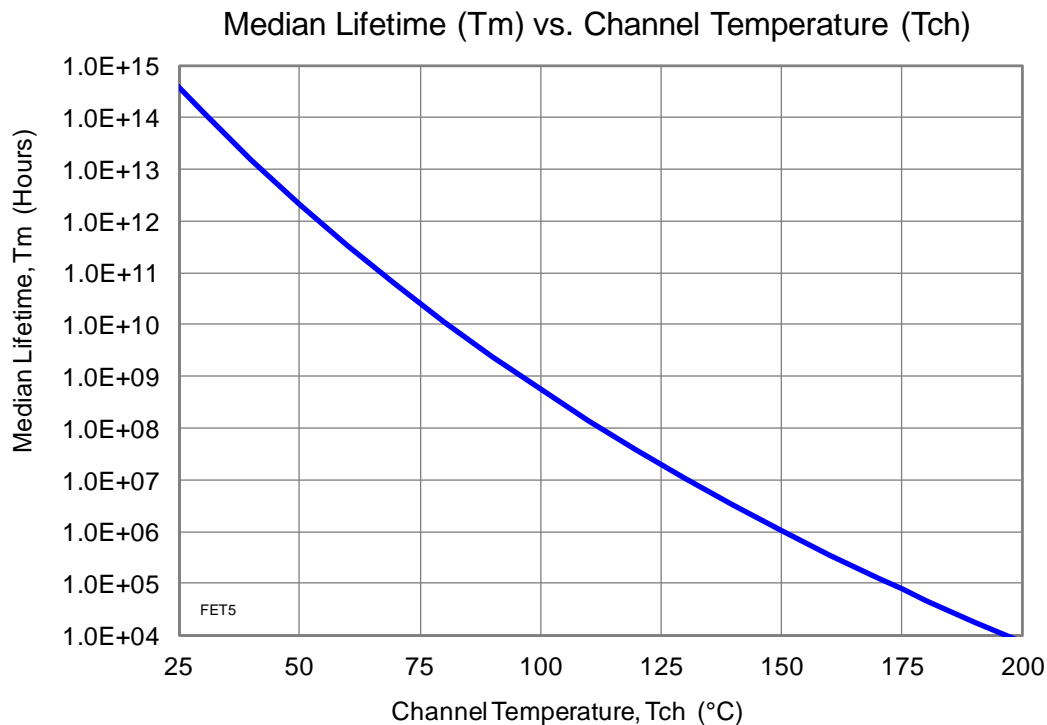

## Tape and reel Information

Standard T/R size = 500 pieces on a 7" reel

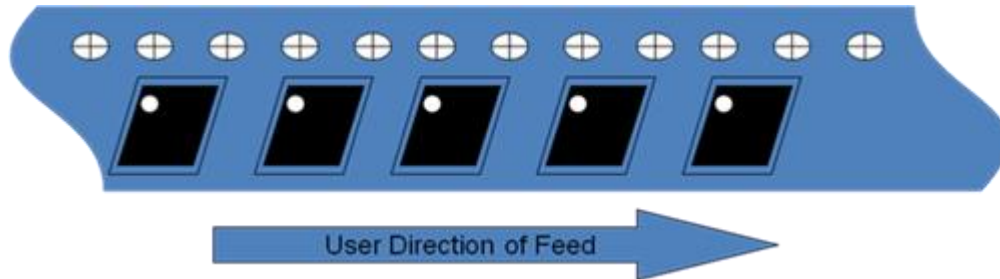

### CARRIER AND COVER TAPE DIMENSIONS

Part	Feature	Symbol	Size (in)	Size (mm)
Cavity	Length	A0	0.209	5.3
	Width	B0	0.209	5.3
	Depth	K0	0.065	1.65
	Pitch	P1	0.314	8
Centerline Distance	Cavity to Perforation – Length Direction	P2	0.079	2
	Cavity to Perforation – Width Direction	F	0.217	5.5
Cover Tape	Width	C	0.362	9.2
Carrier Tape	Width	W	0.472	12

Carrier and Cover Tape Physical Dimensions

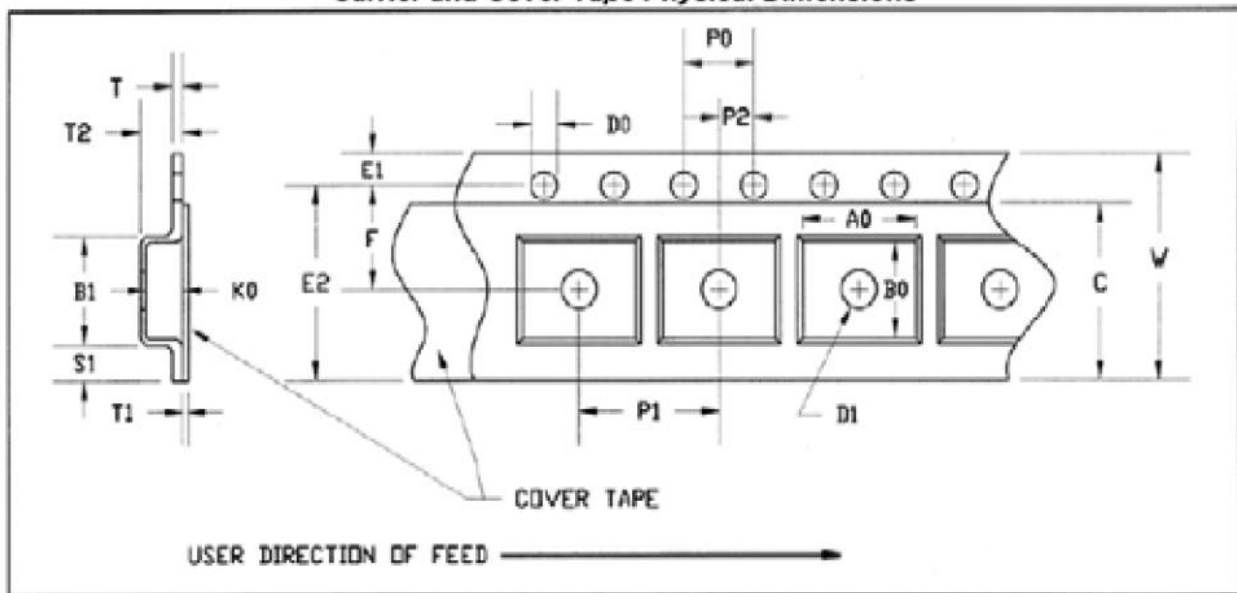

## Solderability

1. Compatible with the latest version of J-STD-020, Lead-free solder, 260 °C
2. The use of no-clean solder to avoid washing after soldering is recommended.
3. Do not expose the package lid to temperatures > 280 °C

## Recommended Soldering Temperature Profile

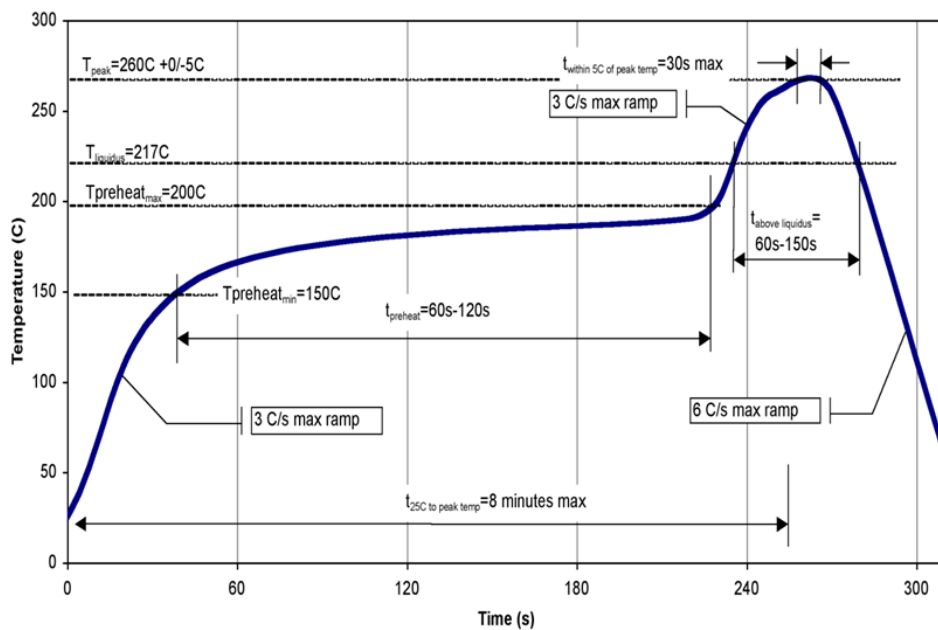

## Handling Precautions

Parameter	Rating	Standard
ESD – Human Body Model (HBM)	Class 0	ANSI/ESD/JEDEC JS-001
ESD – Charged Device Model (HBM)	Class C3	JEDEC JESD22-C101
MSL – Moisture Sensitivity Level	Level 3	IPC/JEDEC J-STD-020



Caution!  
ESD-Sensitive Device

## RoHS Compliance

This product is compliant with the 2011/65/EU RoHS directive (Restrictions on the Use of Certain Hazardous Substances in Electrical and Electronic Equipment), as amended by Directive 2015/863/EU.

This product also has the following attributes:

- Lead Free
- Halogen Free (Chlorine, Bromine)
- Antimony Free
- TBBP-A (C<sub>15</sub>H<sub>12</sub>Br<sub>4</sub>O<sub>2</sub>) Free
- PFOS Free
- SVHC Free

## Contact Information

For the latest specifications, additional product information, worldwide sales and distribution locations:

Web: [www.qorvo.com](http://www.qorvo.com)

Tel: 1-844-890-8163

Email: [customer.support@qorvo.com](mailto:customer.support@qorvo.com)

## Important Notice

The information contained herein is believed to be reliable; however, Qorvo makes no warranties regarding the information contained herein and assumes no responsibility or liability whatsoever for the use of the information contained herein. All information contained herein is subject to change without notice. Customers should obtain and verify the latest relevant information before placing orders for Qorvo products. The information contained herein or any use of such information does not grant, explicitly or implicitly, to any party any patent rights, licenses, or any other intellectual property rights, whether with regard to such information itself or anything described by such information. **THIS INFORMATION DOES NOT CONSTITUTE A WARRANTY WITH RESPECT TO THE PRODUCTS DESCRIBED HEREIN, AND QORVO HEREBY DISCLAIMS ANY AND ALL WARRANTIES WITH RESPECT TO SUCH PRODUCTS WHETHER EXPRESS OR IMPLIED BY LAW, COURSE OF DEALING, COURSE OF PERFORMANCE, USAGE OF TRADE OR OTHERWISE, INCLUDING THE IMPLIED WARRANTIES OF MERCHANTABILITY AND FITNESS FOR A PARTICULAR PURPOSE.**

Without limiting the generality of the foregoing, Qorvo products are not warranted or authorized for use as critical components in medical, life-saving, or life-sustaining applications, or other applications where a failure would reasonably be expected to cause severe personal injury or death.

Copyright 2018 © Qorvo, Inc. | Qorvo is a registered trademark of Qorvo, Inc.