

## DC - 12 GHz Discrete power pHEMT

## TGF2021-12

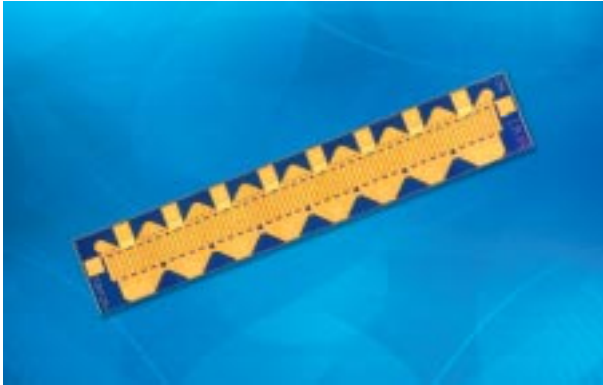

### Key Features and Performance

- Frequency Range: DC - 12 GHz
- > 42 dBm Nominal Psat
- 58% Maximum PAE
- 11 dB Nominal Power Gain
- Suitable for high reliability applications
- 12mm x 0.35 $\mu$ m Power pHEMT
- Nominal Bias Vd = 8-12V, Idq = 900-1500mA (Under RF Drive, Id rises from 900mA to 2560mA)
- Chip Dimensions: 0.57 x 2.93 x 0.10 mm (0.022 x 0.115 x 0.004 in)

### Product Description

The TriQuint TGF2021-12 is a discrete 12 mm pHEMT which operates from DC-12 GHz. The TGF2021-12 is designed using TriQuint's proven standard 0.35 $\mu$ m power pHEMT production process.

The TGF2021-12 typically provides 42 dBm of saturated output power with power gain of 11 dB. The maximum power added efficiency is 59% which makes the TGF2021-12 appropriate for high efficiency applications.

The TGF2021-12 is also ideally suited for Point-to-point Radio, High-reliability space, and Military applications.

The TGF2021-12 has a protective surface passivation layer providing environmental robustness.

Lead-free and RoHS compliant

### Primary Applications

- Point-to-point Radio
- High-reliability space
- Military
- Base Stations
- Broadband Wireless Applications

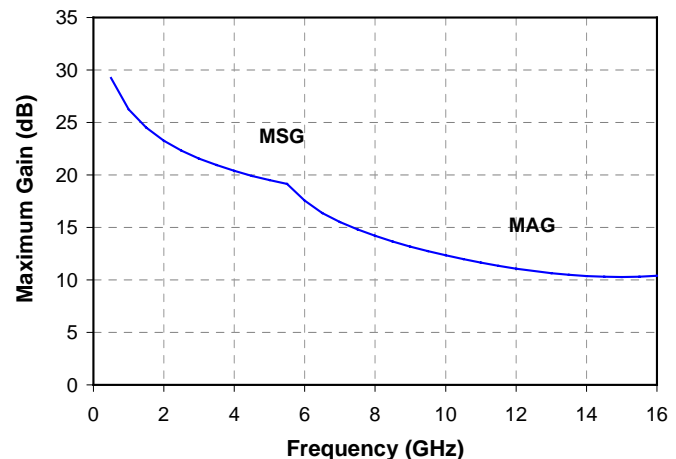

*Note: This device is early in the characterization process prior to finalizing all electrical specifications. Specifications are subject to change without notice.*

**TABLE I**  
**MAXIMUM RATINGS**

Symbol	Parameter <u>1/</u>	Value	Notes
V <sup>+</sup>	Positive Supply Voltage	12.5 V	<u>2/</u>
V <sup>-</sup>	Negative Supply Voltage Range	-5V to 0V	
I <sup>+</sup>	Positive Supply Current	5.6 A	<u>2/</u>
I <sub>G</sub>	Gate Supply Current	70 mA	
P <sub>IN</sub>	Input Continuous Wave Power	36 dBm	<u>2/</u>
P <sub>D</sub>	Power Dissipation	See note 3	<u>2/ 3/</u>
T <sub>CH</sub>	Operating Channel Temperature	150 °C	<u>4/</u>
T <sub>M</sub>	Mounting Temperature (30 Seconds)	320 °C	
T <sub>STG</sub>	Storage Temperature	-65 to 150 °C	

- 1/ These ratings represent the maximum operable values for this device.
- 2/ Combinations of supply voltage, supply current, input power, and output power shall not exceed P<sub>D</sub>.
- 3/ For a median life time of 1E+6 hrs, Power dissipation is limited to:  

$$P_{D(max)} = (150\text{ °C} - T_{BASE}\text{ °C}) / 8.3\text{ (°C/W)}$$
- 4/ Junction operating temperature will directly affect the device median time to failure (T<sub>M</sub>). For maximum life, it is recommended that junction temperatures be maintained at the lowest possible levels.

www.DataSheet4U.com

**TABLE II**  
**DC PROBE CHARACTERISTICS**  
**(T<sub>A</sub> = 25 °C, Nominal)**

Symbol	Parameter	Minimum	Typical	Maximum	Unit
I <sub>DSS</sub>	Saturated Drain Current	-	3600	-	mA
G <sub>m</sub>	Transconductance	-	4500	-	mS
V <sub>P</sub>	Pinch-off Voltage	-1.5	-1	-0.5	V
V <sub>BGS</sub>	Breakdown Voltage Gate-Source	-30	-	-14	V
V <sub>BGD</sub>	Breakdown Voltage Gate-Drain	-30	-	-14	V

Note: For TriQuint's 0.35um power pHEMT devices, RF breakdown >> DC breakdown

**TABLE III**  
**RF CHARACTERIZATION TABLE 1/**  
 (T<sub>A</sub> = 25 °C, Nominal)

SYMBOL	PARAMETER	Vd = 10V Idq = 900mA	Vd = 12V Idq = 900mA	UNITS
<b>Power Tuned:</b>				
Psat	Saturated Output Power	41.5	42	dBm
PAE	Power Added Efficiency	49	47	%
Gain	Power Gain	11	11	dB
Rp <u>2/</u>	Parallel Resistance	2.09	2.86	Ω
Cp <u>2/</u>	Parallel Capacitance	5.861	5.787	pF
Γ <sub>L</sub> <u>3/</u> , <u>4/</u>	Load Reflection coefficient	0.949 ∠ 177.7	0.947 ∠ 176.7	-
<b>Efficiency Tuned:</b>				
Psat	Saturated Output Power	41	41.8	dBm
PAE	Power Added Efficiency	58	52	%
Gain	Power Gain	11.5	11	dB
Rp <u>2/</u>	Parallel Resistance	3.65	4.06	Ω
Cp <u>2/</u>	Parallel Capacitance	6.484	6.223	pF
Γ <sub>L</sub> <u>3/</u> , <u>4/</u>	Load Reflection coefficient	0.956 ∠ 176.1	0.852 ∠ 165.7	-

1/ Values in this table are scaled from measurements taken from a 1.5mm unit pHEMT cell at 10 GHz

2/ Large signal equivalent pHEMT output network

3/ Optimum load impedance for maximum power or maximum PAE at 10 GHz

4/ The reflection coefficients for this device have been calculated from the scaled large signal Rp & Cp. The series resistance and inductance (Rd and Ld) shown in the Figure on page 4 is excluded

**TABLE IV**  
**THERMAL INFORMATION**

Parameter	Test Conditions	T <sub>CH</sub> (°C)	θ <sub>JC</sub> (°C/W)	T <sub>M</sub> (HRS)
θ <sub>JC</sub> Thermal Resistance (channel to backside of carrier)	Vd = 10 V Idq = 900 mA Pdiss = 8.96 W	142	8.3	2E+6

Note: Assumes eutectic attach using 1.5 mil 80/20 AuSn mounted to a 20 mil CuMo Carrier at 70°C baseplate temperature.

**Linear Model for 1.5mm Unit pHEMT Cell**

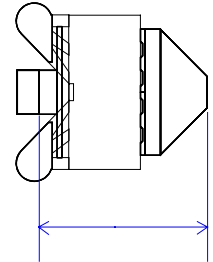
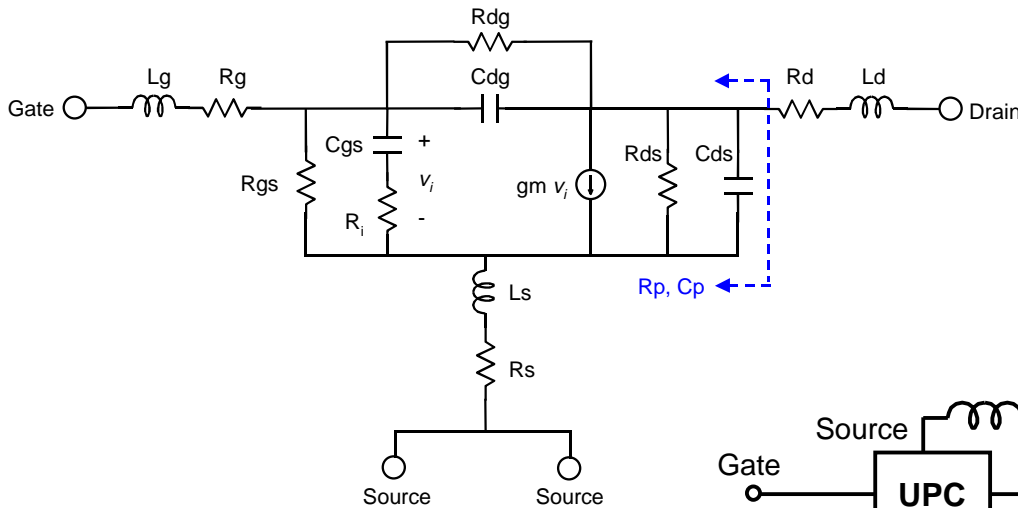

**Unit pHEMT cell Reference Plane**

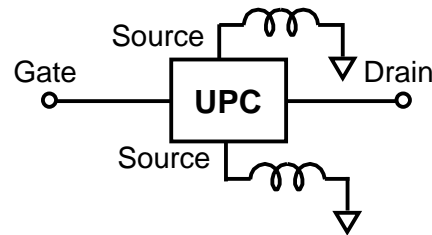

UPC = 1.5 mm Unit pHEMT Cell

MODEL PARAMETER	Vd = 8 V Idq = 112.5 mA	Vd = 8 V Idq = 150 mA	Vd = 8 V Idq = 187.5 mA	Vd = 10 V Idq = 112.5 mA	Vd = 10 V Idq = 150 mA	Vd = 12 V Idq = 112.5 mA	UNITS
Rg	0.430	0.430	0.430	0.430	0.430	0.430	Ω
Rs	0.090	0.080	0.008	0.100	0.090	0.110	Ω
Rd	0.320	0.320	0.330	0.300	0.320	0.280	Ω
gm	0.450	0.457	0.445	0.426	0.429	0.407	S
Cgs	3.504	3.770	3.938	3.800	3.974	3.945	pF
Ri	0.950	0.940	0.960	0.960	0.980	0.990	Ω
Cds	0.300	0.303	0.306	0.301	0.304	0.301	pF
Rds	100.040	102.720	107.550	116.310	118.32	127.590	Ω
Cgd	0.170	0.158	0.150	0.151	0.147	0.143	pF
Tau	6.640	7.050	7.470	7.600	7.920	8.260	pS
Ls	0.070	0.070	0.070	0.070	0.070	0.070	nH
Lg	0.098	0.098	0.098	0.098	0.098	0.098	nH
Ld	0.042	0.040	0.040	0.040	0.039	0.039	nH
Rgs	28700	26700	24000	25500	29500	18100	Ω
Rgd	282000	304000	217000	30400	312000	241000	Ω



# Advance Product Information

September 19, 2005

## TGF2021-12

### Linear Model for 12mm pHEMT

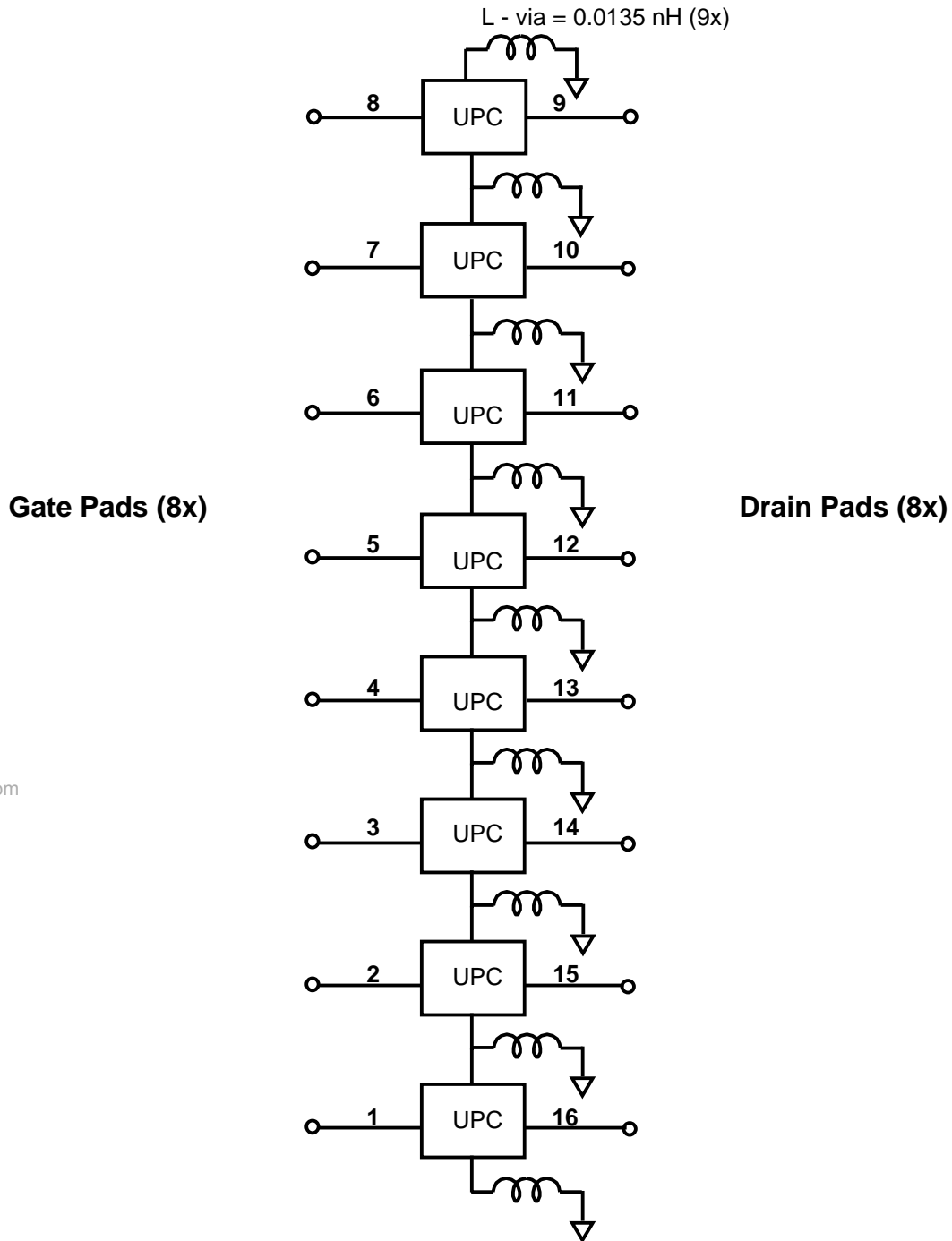

www.DataSheet4U.com



## Advance Product Information

September 19, 2005

### TGF2021-12

## Unmatched S-parameter for 12mm pHEMT

Bias Conditions: Vd=12V Idq=900mA

Frequency (GHz)	s11 dB	s11 ang deg	s21 dB	s21 ang deg	s12 dB	s12 ang deg	s22 dB	s22 ang deg
0.5	-0.174	-170.57	16.046	91.04	-42.423	4.64	-1.989	-177.60
1	-0.173	-175.33	10.021	84.91	-42.446	2.14	-1.958	-177.91
1.5	-0.171	-176.93	6.460	80.41	-42.518	1.29	-1.927	-177.64
2	-0.170	-177.76	3.903	76.35	-42.621	0.92	-1.889	-177.26
2.5	-0.168	-178.26	1.889	72.50	-42.751	0.83	-1.842	-176.86
3	-0.165	-178.61	0.216	68.79	-42.905	0.96	-1.788	-176.48
3.5	-0.163	-178.88	-1.226	65.20	-43.081	1.29	-1.728	-176.14
4	-0.160	-179.09	-2.501	61.73	-43.276	1.84	-1.665	-175.84
4.5	-0.157	-179.26	-3.650	58.35	-43.484	2.62	-1.598	-175.59
5	-0.154	-179.41	-4.700	55.08	-43.702	3.63	-1.530	-175.39
5.5	-0.151	-179.54	-5.670	51.92	-43.925	4.88	-1.461	-175.24
6	-0.148	-179.66	-6.575	48.85	-44.148	6.39	-1.393	-175.13
6.5	-0.145	-179.78	-7.425	45.90	-44.364	8.15	-1.326	-175.07
7	-0.141	-179.88	-8.227	43.04	-44.569	10.16	-1.261	-175.04
7.5	-0.138	-179.98	-8.987	40.28	-44.756	12.41	-1.198	-175.04
8	-0.135	179.92	-9.712	37.62	-44.918	14.88	-1.137	-175.08
8.5	-0.133	179.83	-10.403	35.05	-45.052	17.55	-1.079	-175.14
9	-0.130	179.74	-11.065	32.57	-45.151	20.38	-1.024	-175.22
9.5	-0.128	179.65	-11.701	30.18	-45.212	23.34	-0.972	-175.32
10	-0.125	179.56	-12.312	27.88	-45.233	26.38	-0.922	-175.44
10.5	-0.123	179.47	-12.901	25.65	-45.213	29.46	-0.876	-175.57
11	-0.121	179.39	-13.469	23.51	-45.152	32.53	-0.832	-175.72
11.5	-0.120	179.31	-14.019	21.45	-45.052	35.56	-0.790	-175.87
12	-0.118	179.23	-14.550	19.46	-44.917	38.50	-0.751	-176.03
12.5	-0.116	179.15	-15.064	17.54	-44.749	41.33	-0.715	-176.20
13	-0.115	179.08	-15.562	15.69	-44.553	44.02	-0.681	-176.37
13.5	-0.113	179.00	-16.045	13.91	-44.333	46.57	-0.648	-176.55
14	-0.111	178.93	-16.513	12.19	-44.094	48.96	-0.618	-176.73
14.5	-0.110	178.85	-16.968	10.52	-43.840	51.18	-0.590	-176.91
15	-0.108	178.78	-17.410	8.91	-43.575	53.25	-0.563	-177.09
15.5	-0.107	178.70	-17.841	7.35	-43.302	55.15	-0.538	-177.27
16	-0.105	178.63	-18.260	5.84	-43.023	56.92	-0.514	-177.45
16.5	-0.104	178.55	-18.670	4.38	-42.742	58.54	-0.492	-177.64
17	-0.103	178.48	-19.070	2.97	-42.459	60.03	-0.471	-177.82
17.5	-0.101	178.41	-19.460	1.59	-42.177	61.40	-0.451	-178.00
18	-0.100	178.34	-19.843	0.26	-41.897	62.66	-0.433	-178.18
18.5	-0.099	178.26	-20.217	-1.03	-41.620	63.81	-0.415	-178.36
19	-0.098	178.19	-20.584	-2.29	-41.346	64.88	-0.399	-178.54
19.5	-0.097	178.12	-20.944	-3.50	-41.076	65.85	-0.383	-178.72
20	-0.096	178.05	-21.298	-4.69	-40.810	66.75	-0.368	-178.90
20.5	-0.096	177.98	-21.646	-5.83	-40.549	67.58	-0.354	-179.07
21	-0.095	177.91	-21.989	-6.95	-40.293	68.34	-0.341	-179.24
21.5	-0.094	177.83	-22.326	-8.03	-40.042	69.04	-0.328	-179.42
22	-0.093	177.76	-22.658	-9.08	-39.795	69.68	-0.316	-179.59
22.5	-0.093	177.69	-22.986	-10.10	-39.554	70.28	-0.304	-179.76
23	-0.092	177.62	-23.310	-11.10	-39.318	70.83	-0.294	-179.92
23.5	-0.091	177.55	-23.629	-12.07	-39.086	71.34	-0.283	179.91
24	-0.091	177.48	-23.946	-13.01	-38.859	71.81	-0.273	179.74
24.5	-0.090	177.41	-24.259	-13.94	-38.637	72.24	-0.264	179.58
25	-0.090	177.35	-24.569	-14.85	-38.419	72.64	-0.255	179.42
25.5	-0.089	177.28	-24.877	-15.75	-38.206	73.01	-0.246	179.26
26	-0.089	177.21	-25.184	-16.63	-37.997	73.35	-0.238	179.10

Note: The s-parameters are calculated by connecting nodes 1-8 together, and nodes 9-16 together to form a 2-port network.



# Advance Product Information

September 19, 2005

## TGF2021-12

### Mechanical Drawing

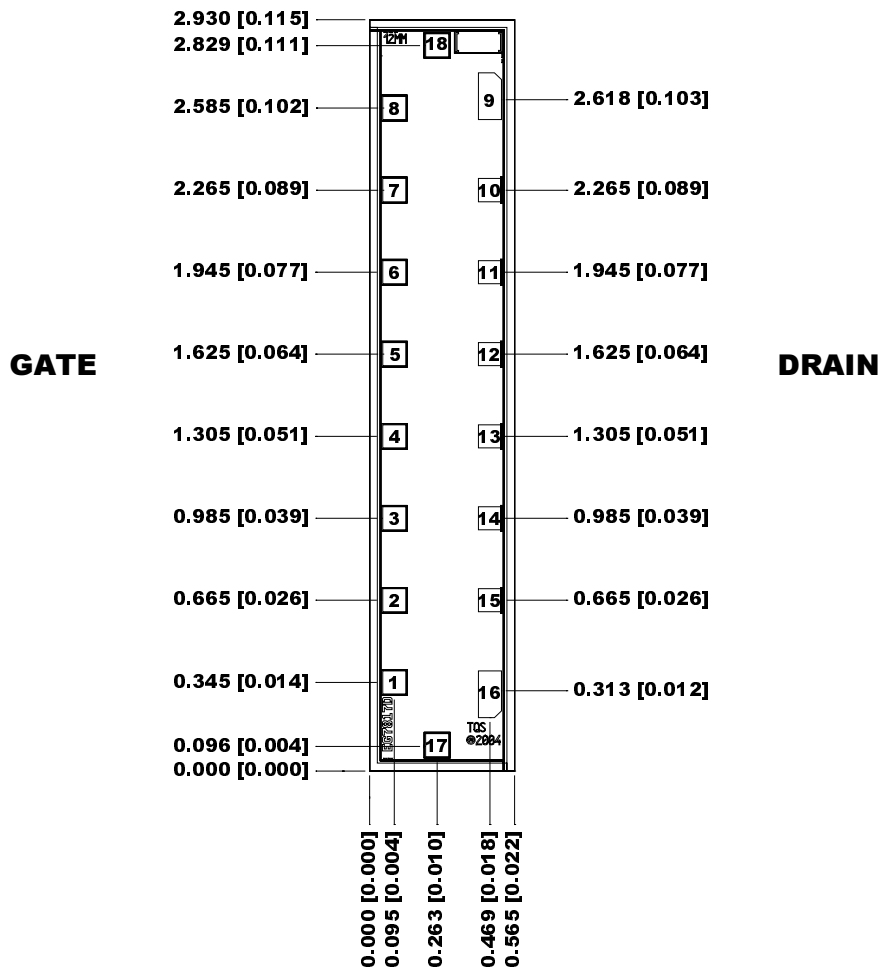

www.DataSheet4U.com

**Units: millimeters (inches)**  
**Thickness: 0.100 (0.004)**  
**Chip edge to bond pad dimensions are shown to center of bond pad**  
**Chip size tolerance: +/- 0.051 (0.002)**

**GND IS BACKSIDE OF MMIC**

**Bond pads # 1-8: (Gate) 0.090 x 0.090 (0.004 x 0.004)**  
**Bond pads # 9-16: (Drain) 0.090 x 0.090 (0.004 x 0.004)**  
**Bond Pad #17: (Vg\*) 0.090 x 0.090 (0.004 x 0.004)**  
**Bond Pad #18: (Vg\*) 0.090 x 0.090 (0.004 x 0.004)**

**\*Note: Bond pads #17 & 18 are alternate gate pads that can be used for paralleling FETs.**

*GaAs MMIC devices are susceptible to damage from Electrostatic Discharge. Proper precautions should be observed during handling, assembly and test.*



## Advance Product Information

September 19, 2005

**TGF2021-12**

### Assembly Process Notes

Reflow process assembly notes:

- Use AuSn (80/20) solder with limited exposure to temperatures at or above 300 °C for 30 sec
- An alloy station or conveyor furnace with reducing atmosphere should be used.
- Do not use flux
- Coefficient of thermal expansion matching is critical for long-term reliability.
- Devices must be stored in a dry nitrogen atmosphere.

Component placement and adhesive attachment assembly notes:

- Vacuum pencils and/or vacuum collets are the preferred method of pick up.
- Air bridges must be avoided during placement.
- The force impact is critical during auto placement.
- Organic attachment can be used in low-power applications.
- Curing should be done in a convection oven; proper exhaust is a safety concern.
- Microwave or radiant curing should not be used because of differential heating.
- Coefficient of thermal expansion matching is critical.

Interconnect process assembly notes:

- Thermosonic ball bonding is the preferred interconnect technique.
- Force, time, and ultrasonics are critical parameters.
- Aluminum wire should not be used.
- Devices with small pad sizes should be bonded with 0.0007-inch wire.
- Maximum stage temperature is 200 °C.