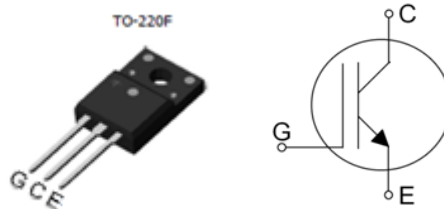

**Features:**

- 400V Trench Technology
- High Speed Switching
- Low Conduction Loss
- Positive Temperature Coefficient
- Easy parallel Operation
- RoHS compliant
- JEDEC Qualification

**Applications :**

Plasma Display Panel, Soft switching application,

Ordering Part Number	Package	Packaging type	Marking	Remark
TGPF30N40P	TO-220F	Tube	TGPF30N40P	RoHS
TGPF30N40P-R	TO-220F(R-Forming)	Tube	TGPF30N40P	RoHS
TGPF30N40P-L	TO-220F(L-Forming)	Tube	TGPF30N40P	RoHS

**Absolute Maximum Ratings**

Parameter	Symbol	Value	Unit	
Collector-Emitter Voltage	$V_{CES}$	400	V	
Gate-Emitter Voltage	$V_{GES}$	±30	V	
Continuous Current	$I_c$	$T_C = 25\text{ }^\circ\text{C}$	60	A
		$T_C = 100\text{ }^\circ\text{C}$	30	A
Pulsed Collector Current (Note 1)	$I_{CM}$	300	A	
Power Dissipation	$P_D$	$T_C = 25\text{ }^\circ\text{C}$	20.8	W
		$T_C = 100\text{ }^\circ\text{C}$	8.3	W
Operating Junction Temperature	$T_J$	-55 ~ 150	$^\circ\text{C}$	
Storage Temperature Range	$T_{STG}$	-55 ~ 150	$^\circ\text{C}$	
Maximum lead temperature for soldering purposes, 1/8" from case for 5 seconds	$T_L$	300	$^\circ\text{C}$	

Notes :

 (1) Repetitive rating : Pulse width limited by max junction temperature,  $PW \leq 10\mu\text{s}$ , duty cycle  $\leq 1\%$ .

**Thermal Characteristics**

Parameter	Symbol	Value	Unit
Maximum Thermal resistance, Junction-to-Case	$R_{\theta JC}$	6.0	$^\circ\text{C/W}$
Maximum Thermal resistance, Junction-to-Ambient	$R_{\theta JA}$	62.5	$^\circ\text{C/W}$

**Electrical Characteristics of the IGBT**  $T_C=25^\circ\text{C}$ , unless otherwise noted

Parameter	Symbol	Test condition	Min	Typ	Max	Units
<b>OFF</b>						
Collector – Emitter Breakdown Voltage	$BV_{CES}$	$V_{GE} = 0V, I_C = 1mA$	400	--	--	V
Zero Gate Voltage Collector Current	$I_{CES}$	$V_{CE} = 400V, V_{GE} = 0V$	--	--	100	$\mu A$
Gate – Emitter Leakage Current	$I_{GES}$	$V_{CE} = 0V, V_{GE} = \pm 30V$	--	--	$\pm 250$	nA

<b>ON</b>						
Gate – Emitter Threshold Voltage	$V_{GE(TH)}$	$V_{GE} = V_{CE}, I_C = 1mA$	2	3.1	4.5	V
Collector – Emitter Saturation Voltage	$V_{CE(SAT)}$	$V_{GE} = 15V, I_C = 30A, T_J = 25^\circ\text{C}$	--	1.4	2.0	V
		$V_{GE} = 15V, I_C = 30A, T_J = 125^\circ\text{C}$	--	1.52	--	V

<b>DYNAMIC</b>						
Input Capacitance	$C_{IES}$	$V_{CE} = 25V,$ $V_{GE} = 0V,$ $f = 1MHz$	--	845	--	pF
Output Capacitance	$C_{OES}$		--	50	--	pF
Reverse Transfer Capacitance	$C_{RES}$		--	23	--	pF

<b>SWITCHING</b>						
Turn-On Delay Time	$t_{d(on)}$	$V_{CC} = 150V, I_C = 30A,$ $R_G = 5\Omega, V_{GE} = 15V,$ Resistive Load, $T_J = 25^\circ\text{C}$	--	13	--	ns
Rise Time	$t_r$		--	105	--	ns
Turn-Off Delay Time	$t_{d(off)}$		--	35	--	ns
Fall Time	$t_f$		--	160	--	ns
Turn-On Delay Time	$t_{d(on)}$	$V_{CC} = 150V, I_C = 30A,$ $R_G = 5\Omega, V_{GE} = 15V,$ Resistive Load, $T_J = 125^\circ\text{C}$	--	14	--	ns
Rise Time	$t_r$		--	145	--	ns
Turn-Off Delay Time	$t_{d(off)}$		--	40	--	ns
Fall Time	$t_f$		--	240	--	ns
Total Gate Charge	$Q_g$	$V_{CC} = 150V, I_C = 30A,$ $V_{GE} = 15V$	--	26	--	nC
Gate-Emitter Charge	$Q_{ge}$		--	3.1	--	nC
Gate-Collector Charge	$Q_{gc}$		--	9	--	nC

Fig. 1 Output characteristics

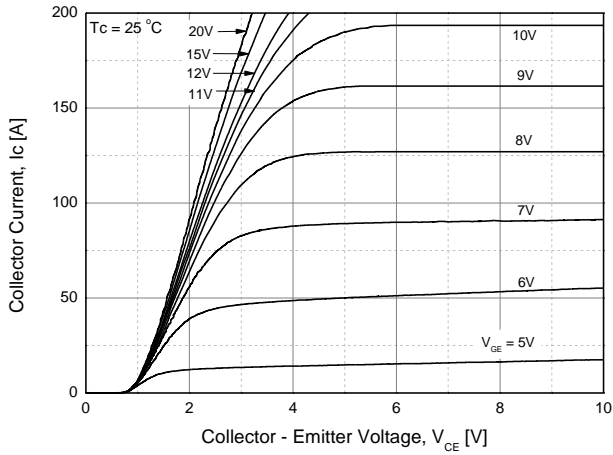

Fig. 2 Saturation voltage characteristics

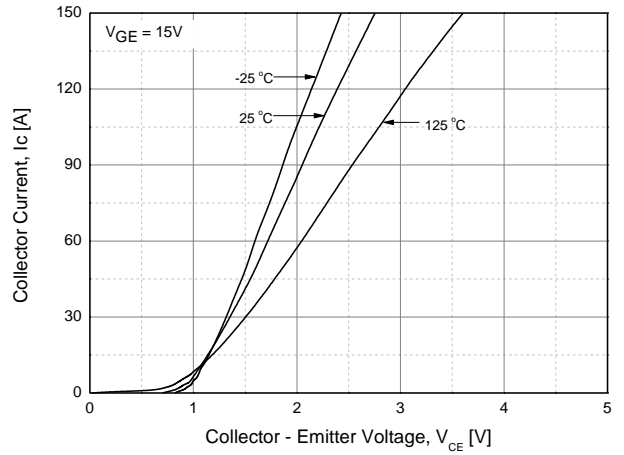

Fig. 3 Saturation voltage vs. collector current

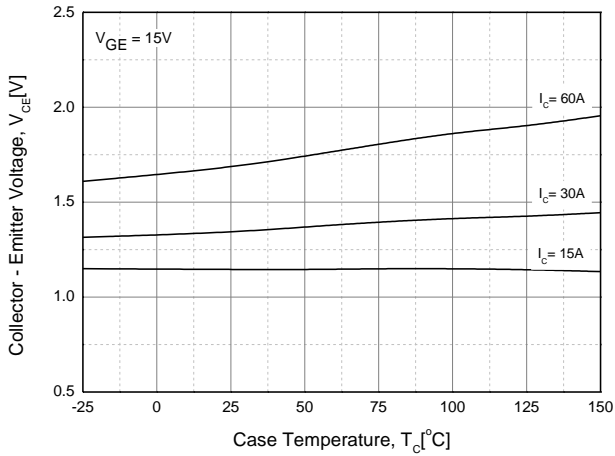

Fig. 4 Saturation voltage vs. gate bias

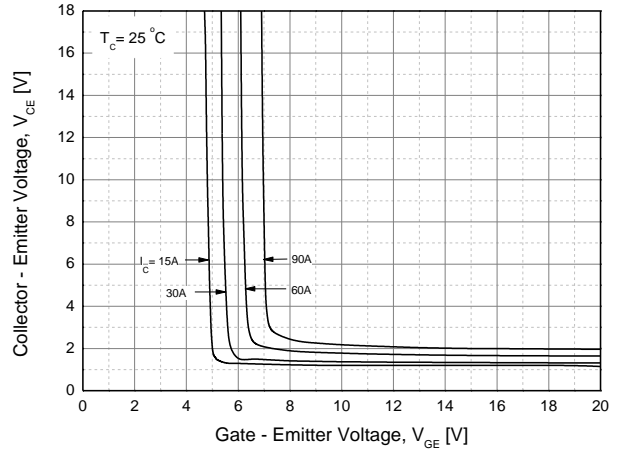

Fig. 5 Saturation voltage vs. gate bias

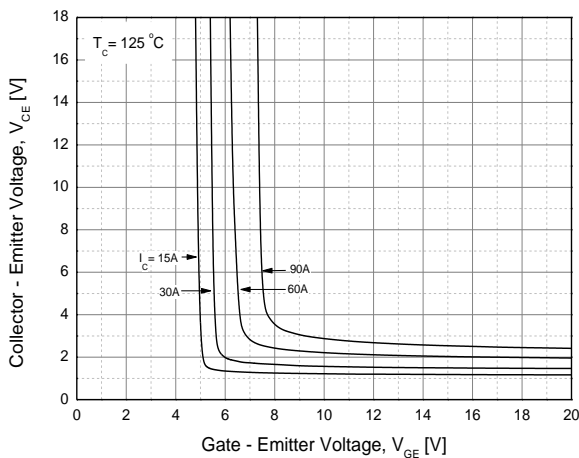

Fig. 6 Capacitance characteristics

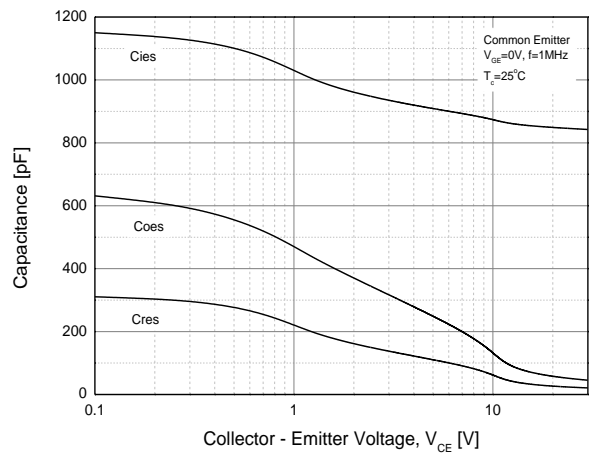

Fig. 7 Turn on time vs. gate resistance

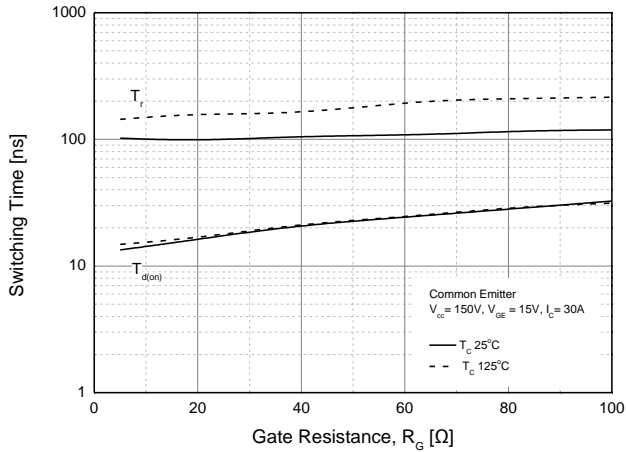

Fig. 8 Turn on time vs. collector current

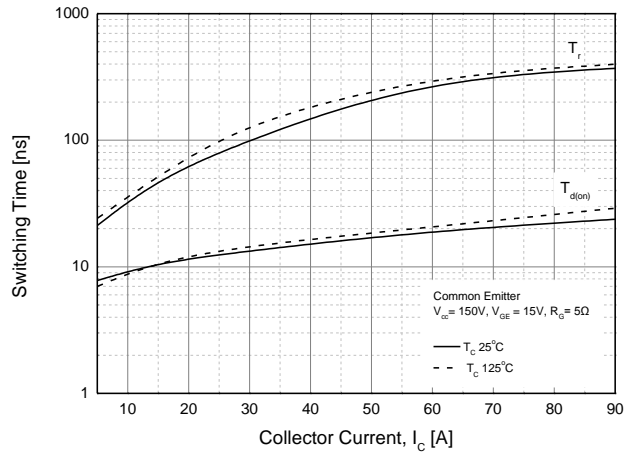

Fig. 9 Turn on time vs. Case temperature

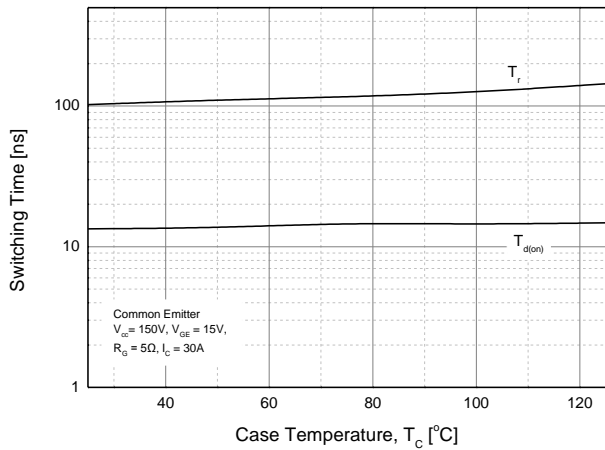

Fig. 10 Turn off time vs. gate resistance

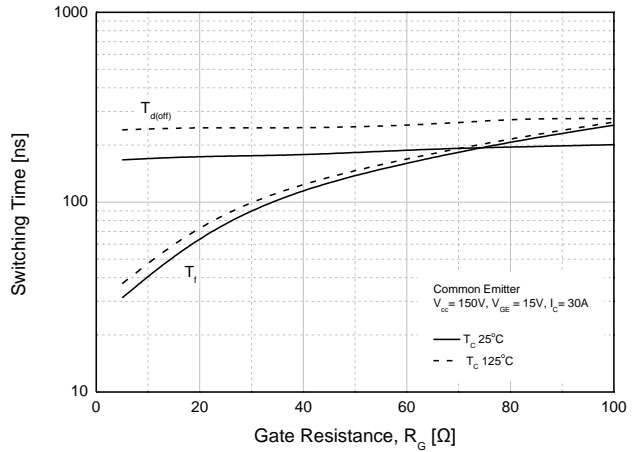

Fig. 11 Turn off time vs. collector current

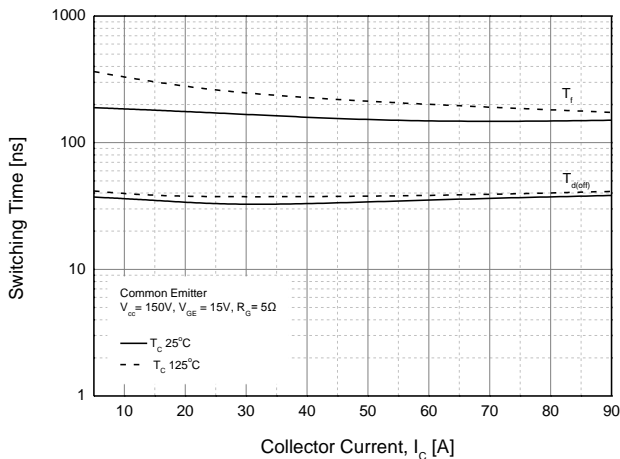

Fig. 12 Turn off time vs. Case temperature

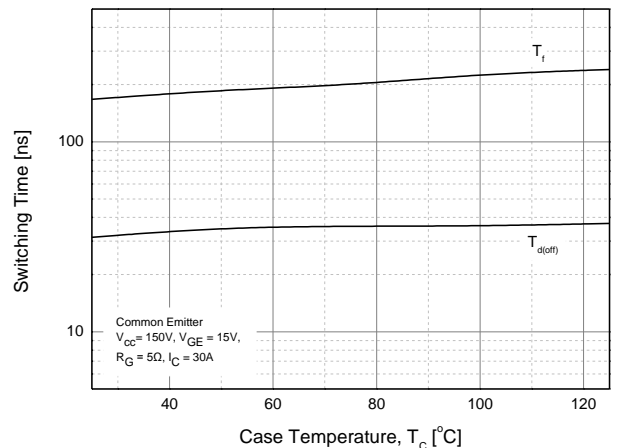

Fig. 13 Gate charge characteristics

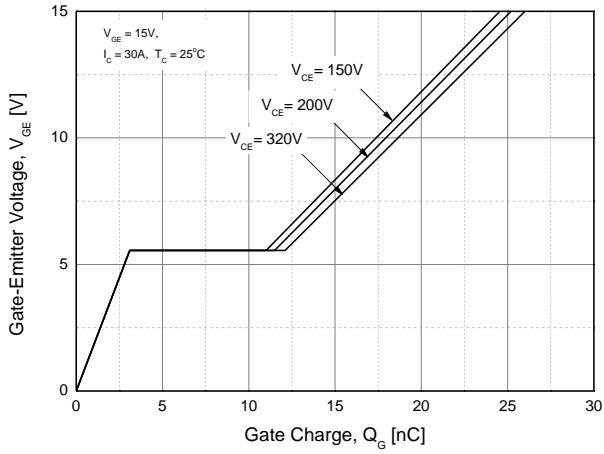

Fig. 14 SOA

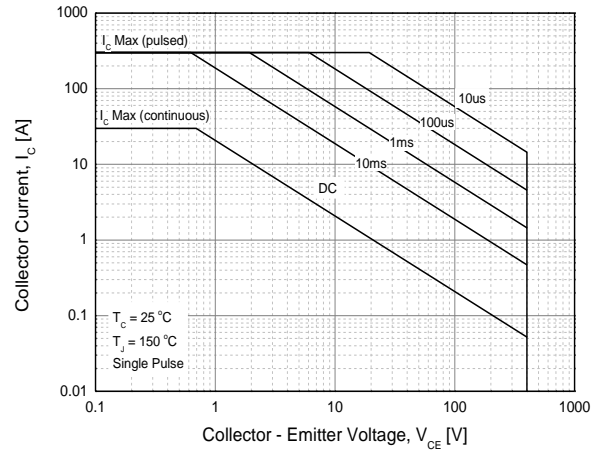

Fig. 15 RBSOA

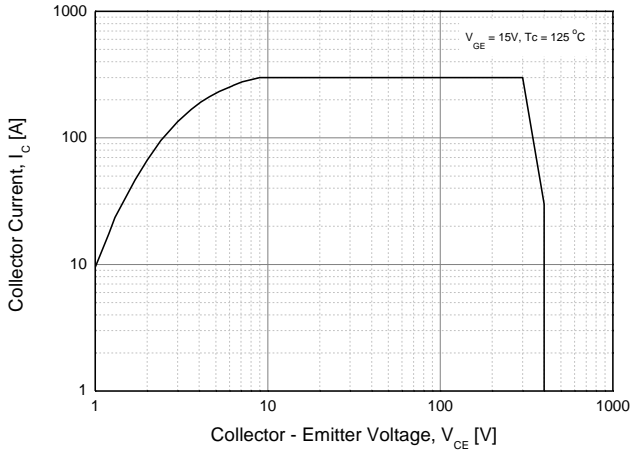
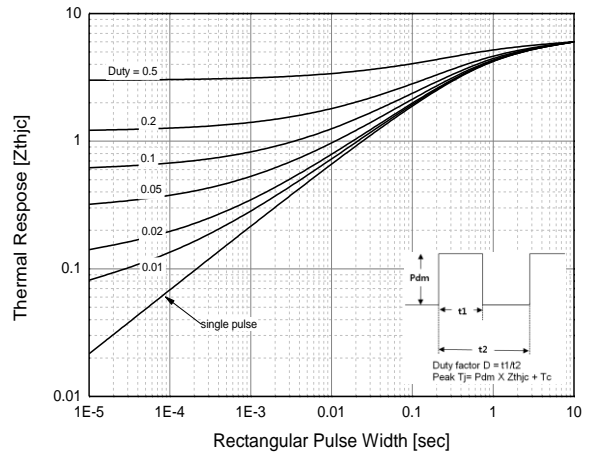
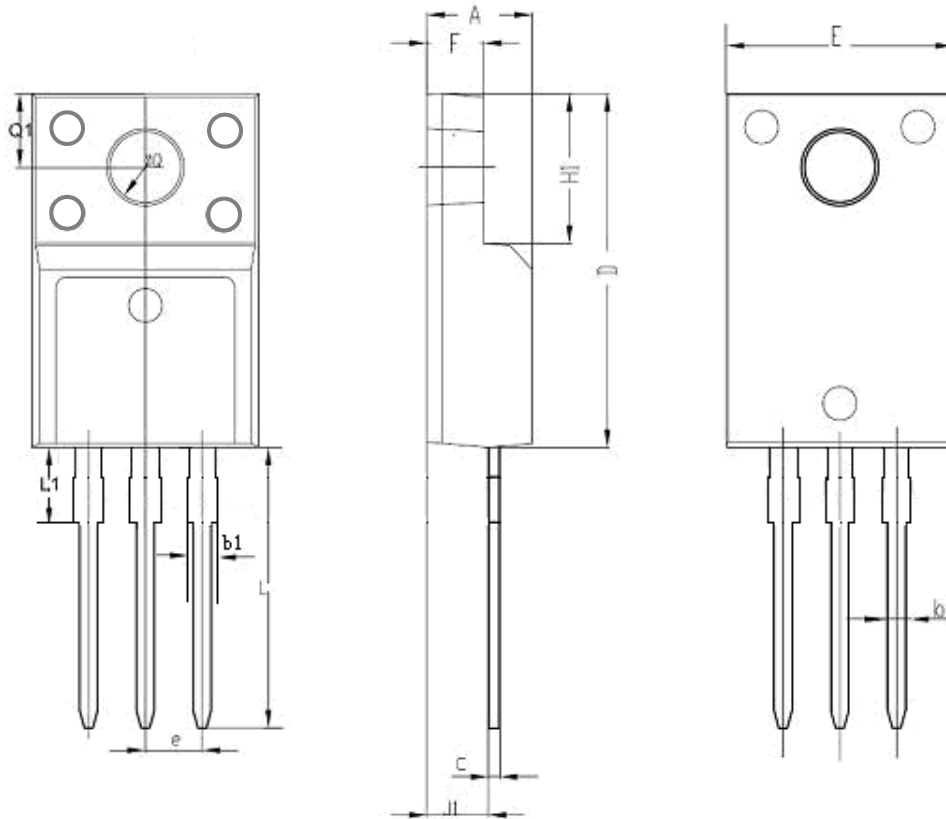

Fig. 16 Transient thermal impedance



TO-220F-3L MECHANICAL DATA



SYMBOL	INCHES		MILLIMETERS		NOTES
	MIN	MAX	MIN	MAX	
A	0.178	0.194	4.53	4.93	
b	0.028	0.036	0.71	0.91	
C	0.018	0.024	0.45	0.60	
D	0.617	0.633	15.67	16.07	
E	0.392	0.408	9.96	10.36	
e	0.100 TYP.		2.54TYP.		
H1	0.256	0.272	6.50	6.90	
J1	0.101	0.117	2.56	2.96	
L	0.503	0.519	12.78	13.18	
φQ	0.117	0.133	2.98	3.38	
b1	0.045	0.055	1.15	1.39	
L1	0.114	0.130	2.9	3.3	
Q1	0.122	0.138	3.10	3.50	
F	0.092	0.108	2.34	2.74	