

Applications

- High Power Switching

Product Features

- Frequency Range: 0.5 - 6 GHz
- Insertion Loss: < 1.3 dB
- Power Handling: 100 W
- Isolation: 40 dB typical
- Control Voltages: 0 V/-40 V from either side of the MMIC
- Reflective Switch
- Chip Dimensions: 2.14 x 2.50 x 0.1 mm

General Description

The TGS2355 is a single-pole, double-throw (SPDT) reflective switch fabricated on TriQuint's 0.25um GaN on SiC production process. Operating from 0.5 to 6 GHz, the TGS2355 provides up to 100 W input power handling with < 1 dB insertion over most of the operating band and greater than 40 dB isolation.

The TGS2355 is available in a small 2.14 x 2.50 mm die size and requires very little control current allowing for easy system integration without impacting system power budgets.

The TGS2355 is ideally suited for high power switching applications across both defense and commercial applications.

Lead-free and RoHS compliant.

Evaluation boards available on request.

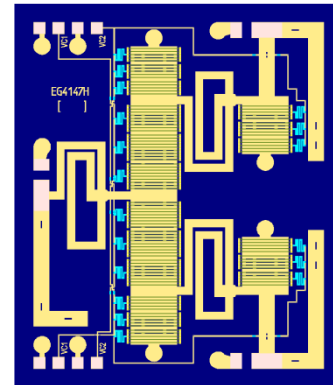

Functional Block Diagram

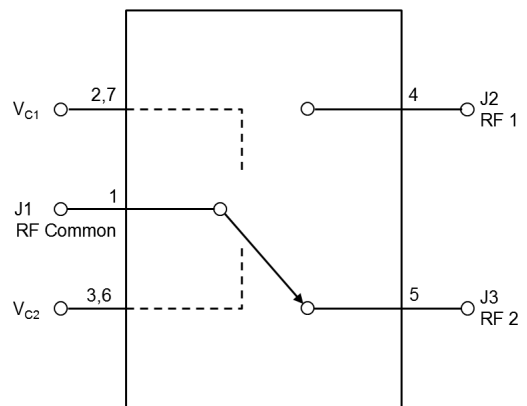

Pin Configuration

Pin No.	Label
1	RF C
2, 7	V _{C1}
3, 6	V _{C2}
4	RF1
5	RF2

Ordering Information

Part No.	ECCN	Description
TGS2355	EAR99	0.5-6 GHz High Power GaN Switch

Absolute Maximum Ratings

Parameter	Rating
Control Voltage (V _c)	-50 V
Control Current (I _c)	-3.5 / +3.5 mA
Power Dissipation	36.8 W
RF Input Power (pulsed, 10% Duty Cycle, 20us pulse width)	51 dBm
Channel Temperature, T _{CH}	275 °C
Mounting Temperature (30 sec)	320 °C
Storage Temperature	-55 to 150 °C

Operation of this device outside the parameter ranges given above may cause permanent damage.

Recommended Operating Conditions

Parameter	Min	Typ	Max	Units
Frequency	0.5		6	GHz
Input Power Handling (pulsed)		≤ 50		dBm
Control Voltage		-40		V
Channel Temp., T _{ch}		225		°C

Electrical specifications are measured at specified test conditions. Specifications are not guaranteed over all recommended operating conditions.

Electrical Specifications

Test conditions unless otherwise noted: Temp= +25°C. Z₀ = 50 Ω, V_c=-40 V

Parameter	Min	Typ	Max	Units
Operational Frequency Range	0.5		6	GHz
P-0.1dB (pulsed)		50		dBm
Control Current (I _c)		1.0		mA
Insertion Loss (On-State)		1.0		dB
Input Return Loss – On-State (Common Port RL)		15		dB
Output Return Loss – On-State (Switched Port RL)		15		dB
Isolation (Off-State)		40		dB
Output Return Loss – Off-State (Isolated Port RL)		2.5		dB
Control Voltage		-40	-48	V
Insertion Loss Temperature Coefficient		0.003		dB/ °C

Specifications

Thermal and Reliability Information

Parameter	Conditions	Value	Units
Thermal Resistance (θ_{JC}) ⁽¹⁾	$T_{BASE} = 85\text{ }^\circ\text{C}$, $V_{C1} = 0\text{ V}$, $V_{C2} = -40\text{ V}$, $P_{IN} = 100\text{ W (CW)}$, $P_{DISS} = 29.3\text{ W}$	4.78	$^\circ\text{C/W}$
Channel Temperature (T_{CH})		225	$^\circ\text{C}$
Median Lifetime (T_M)		1.56E06	Hrs

Notes:

1. MMIC soldered to 20 mil thick Cu-Mo carrier plate using 1.5 mil thick AuSn solder. Thermal resistance is determined from the channel to the back of the carrier plate (fixed 85 $^\circ\text{C}$ temperature).

Median Lifetime

Test Conditions: 40 V; Failure Criteria = 10% reduction in $I_{D\text{ MAX}}$

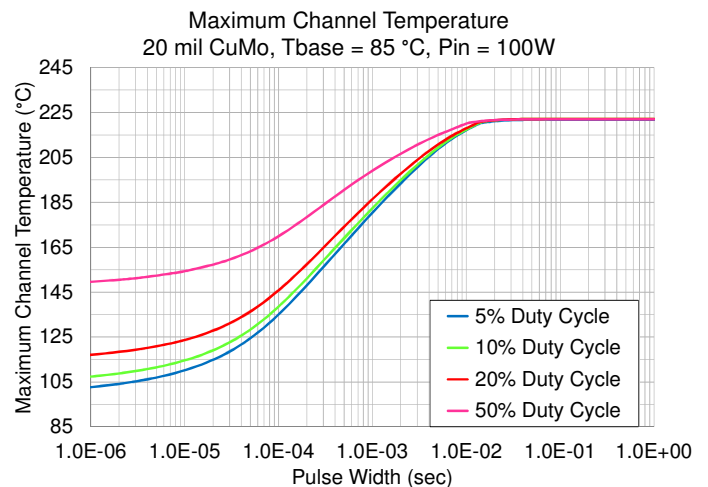
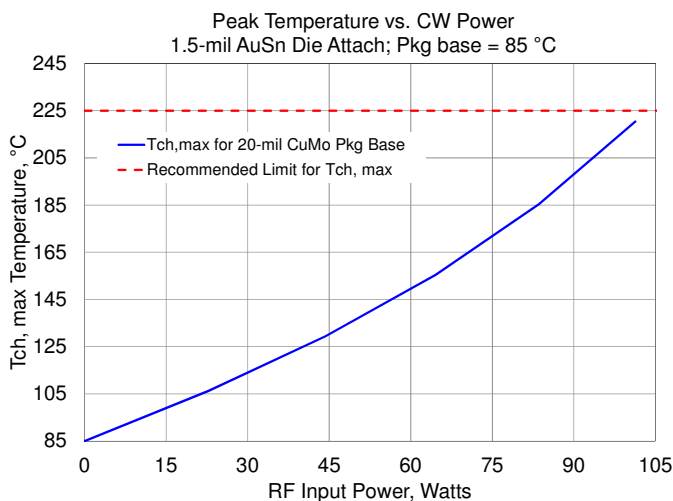
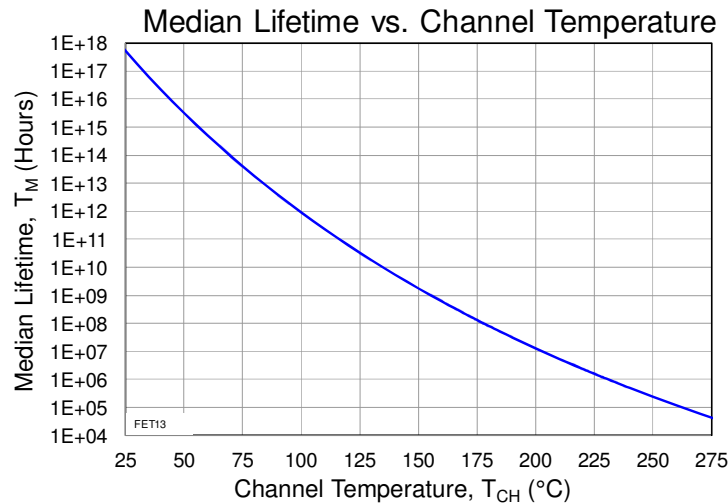

Typical Performance (Tuned EVB)

Test conditions unless otherwise noted: $V_{C1} = 0$ V, $V_{C2} = -40$ V, CW Input, Temp = +25 °C

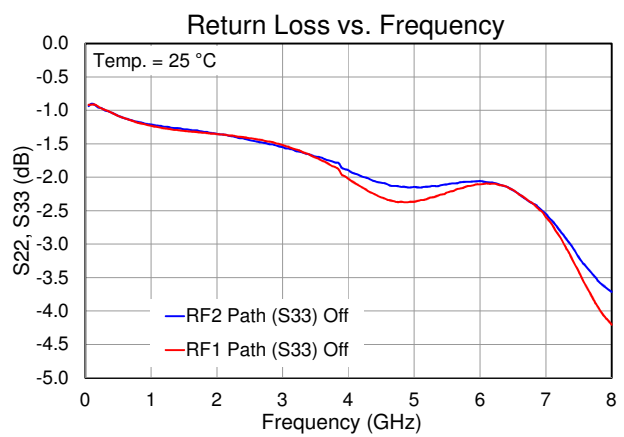
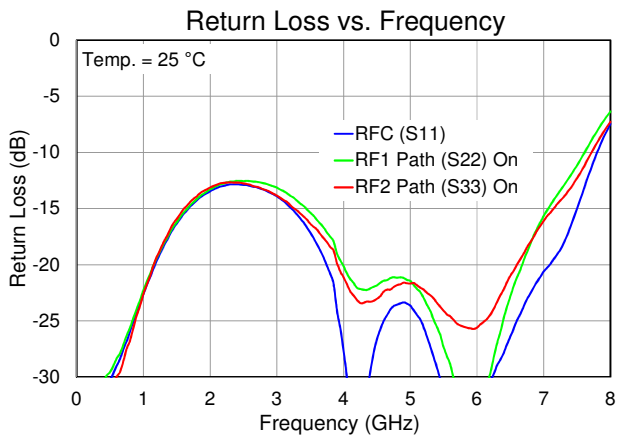
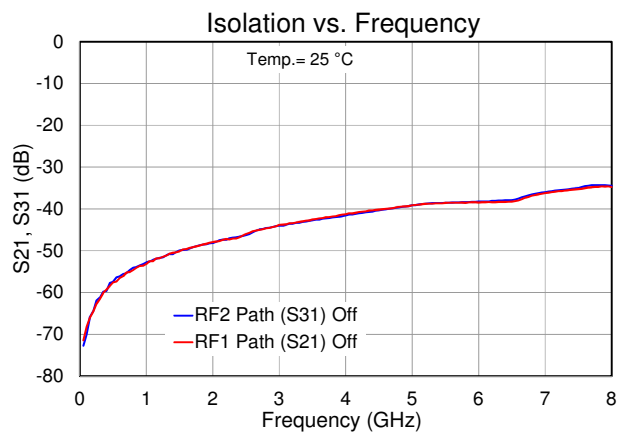
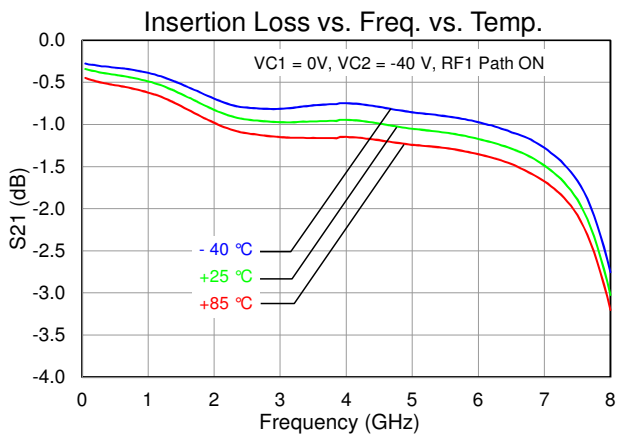
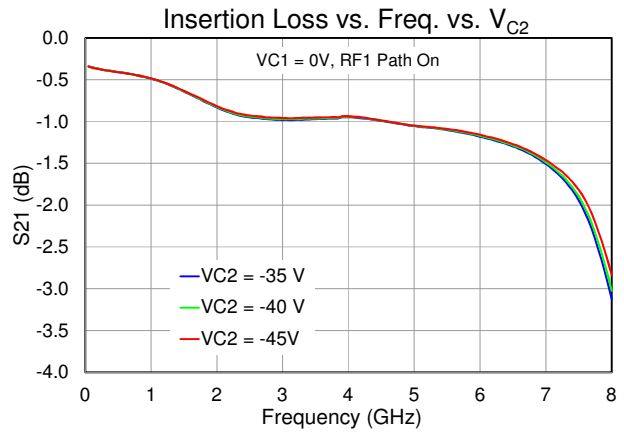
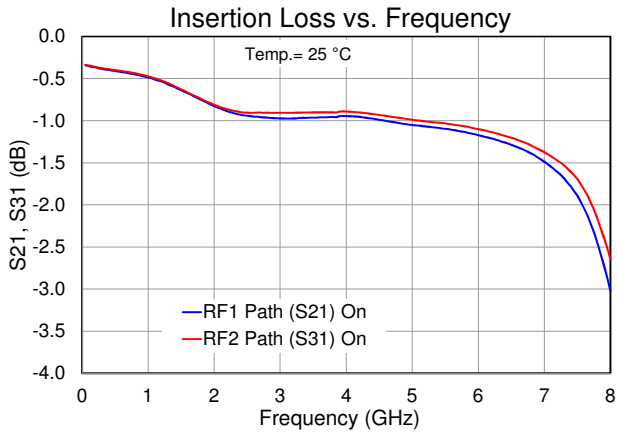

Typical Performance (Tuned EVB)

Test conditions unless otherwise noted: $V_{C1} = 0$ V, $V_{C2} = -40$ V, Pulsed RF Input PW=20 usec, Duty Cycle=10%, Temp= +25 °C

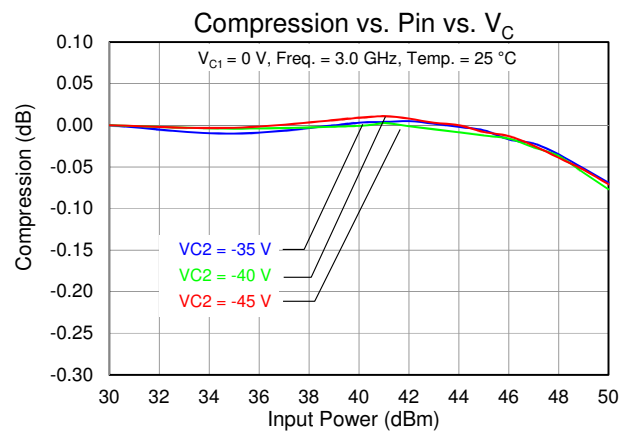
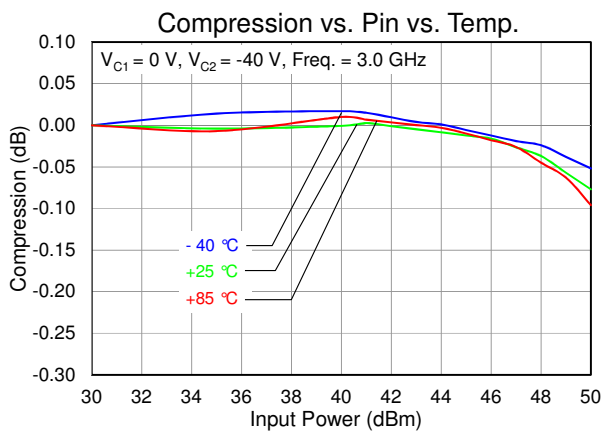
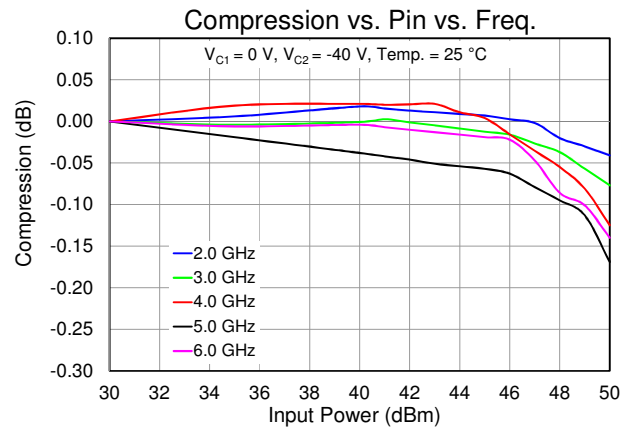
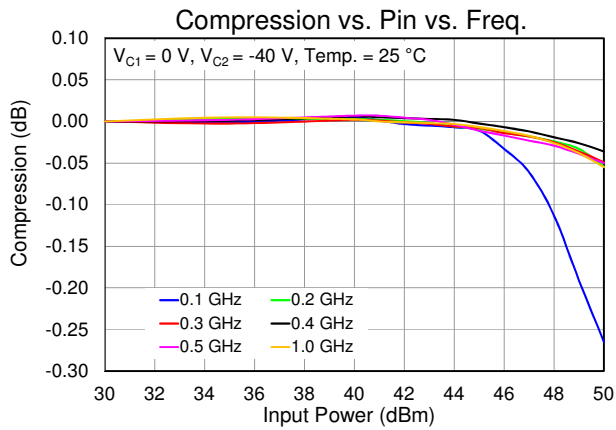

Application Circuit

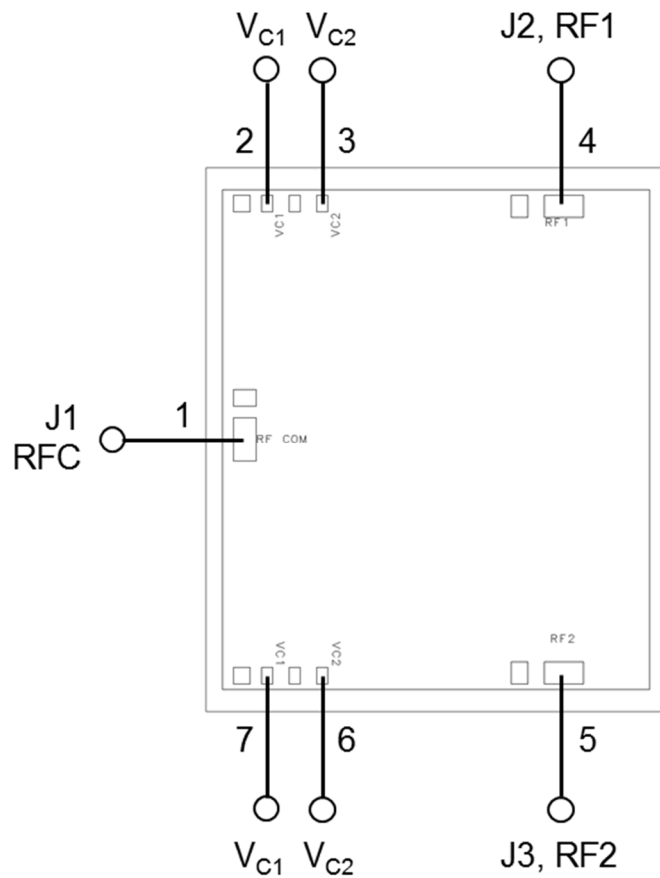

Notes:

DC blocking capacitors are required on all RF ports.

V_{C1} can be biased from either bond pad 3 or 6, and the non-biased bond pad can be left open.
 V_{C2} can be biased from either bond pad 2 or 7, and the non-biased bond pad can be left open.

This switch can be configured as a Single Pole, Single Throw (SPST) by terminating one unused RF switched port with a 50 Ohm load.

Function Table

RF Path	State	V_{C1}	V_{C2}
RFC to RF1	On-State (Insertion Loss)	0 V	-40 V
	Off-State (Isolation)	-40 V	0 V
RFC to RF2	On-State (Insertion Loss)	-40 V	0 V
	Off-State (Isolation)	0 V	-40 V

Applications Information

Evaluation Board Layout

RF Layer is 0.010" thick Rogers Corp. RO4350B, $\epsilon_r = 3.66$. Metal layers are 0.5 oz. copper. The microstrip line at the connector interface is optimized for the Southwest Microwave end launch connector 1092-02A-5.

The pad pattern shown has been developed and tested for optimized assembly at TriQuint Semiconductor. The PCB land pattern has been developed to accommodate lead and package tolerances. Since surface mount processes vary from company to company, careful process development is recommended.

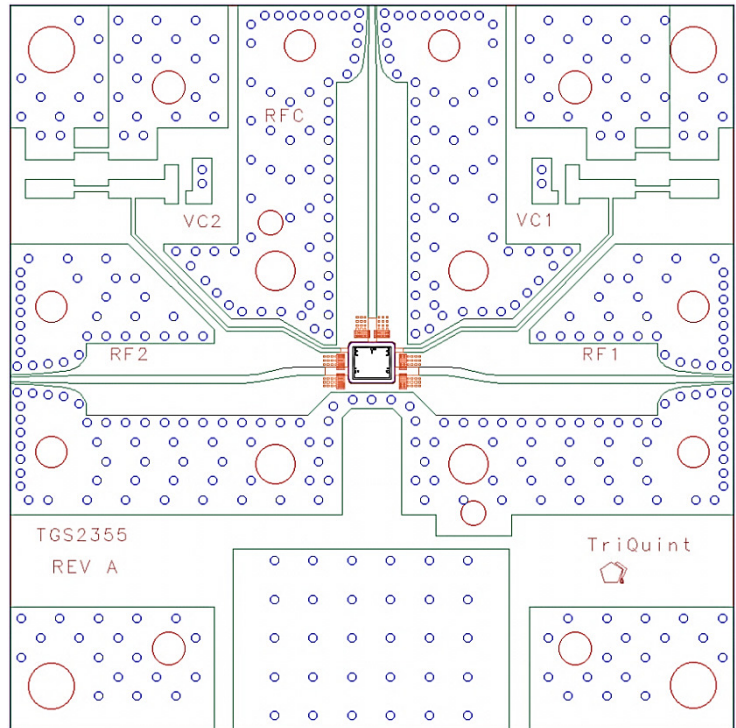

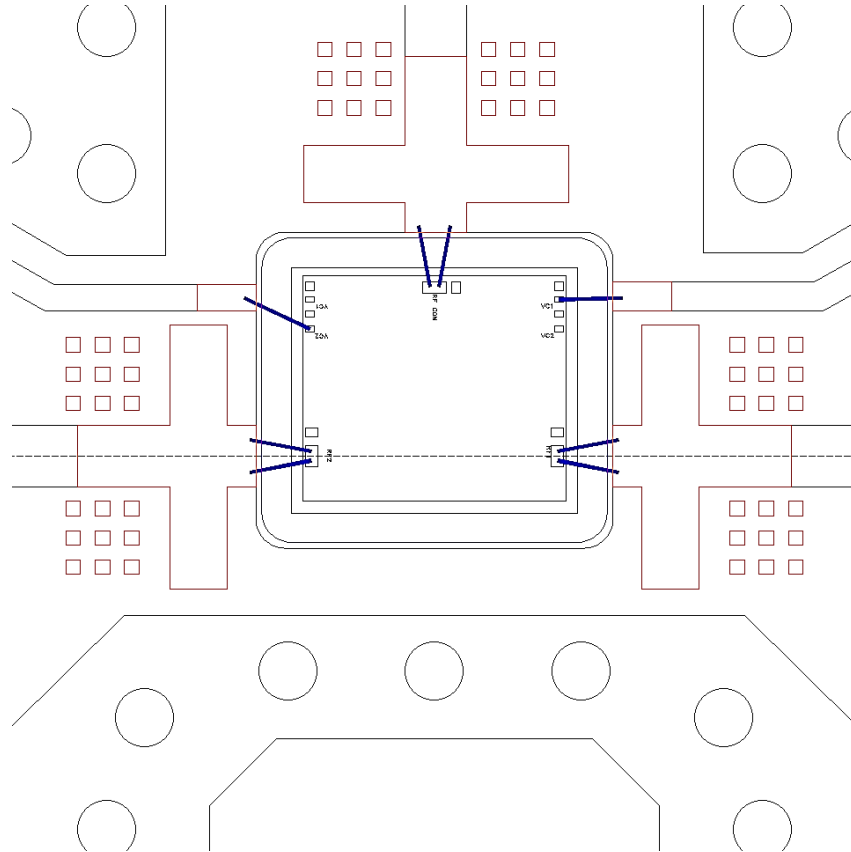
Mounting Detail**MMIC EVB Mounting Detail****Notes:**

1. MMIC is mounted directly to the carrier plate in a cut-out area of the EVB.
2. Flares (as shown) on RF transmission lines are required to achieve best electrical performance.

Mechanical Drawing and Bond Pad Description

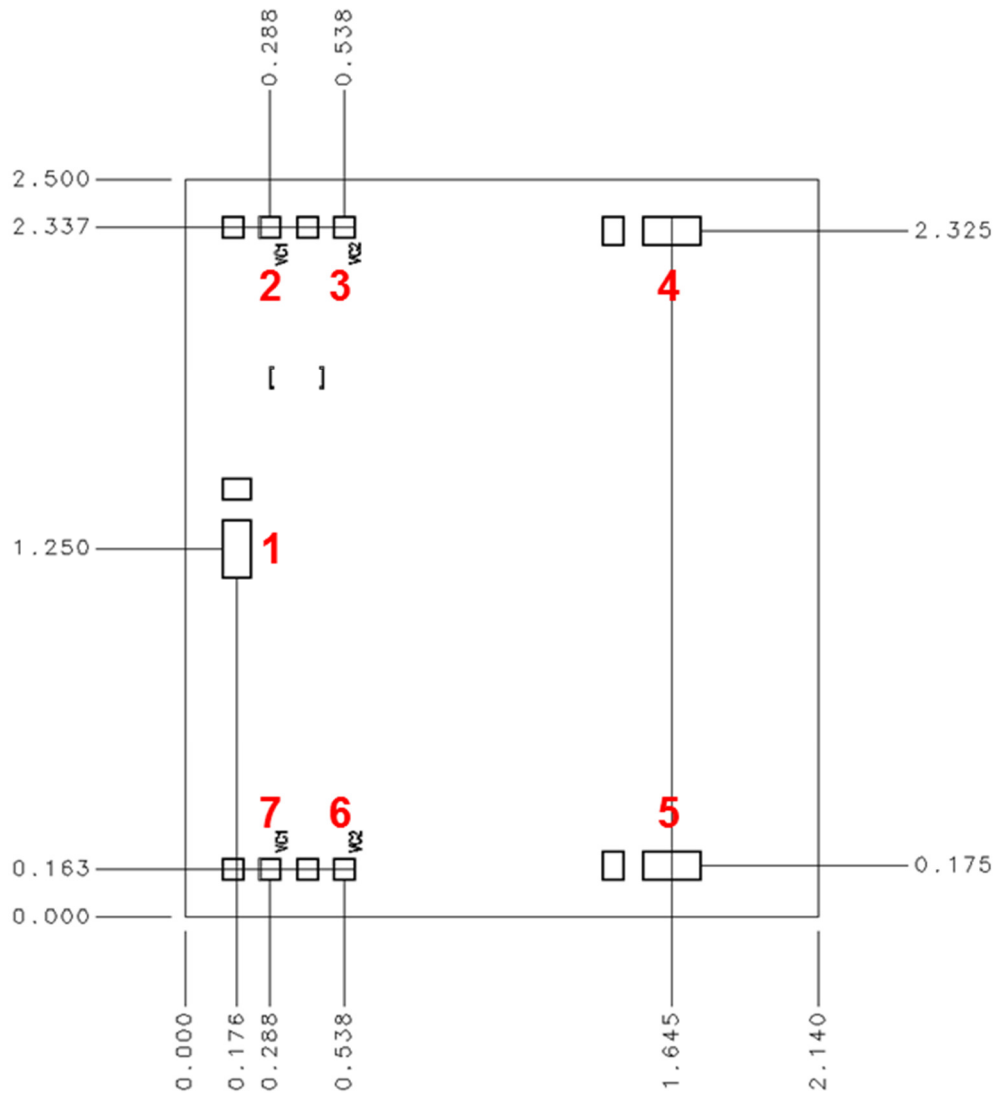

Pin No.	Label	Description	Pad Size (um)
1	RFC	Common RF Port, DC coupled	100 x 200
2, 7	V _{C1}	Control 1	75 x 75
3, 6	V _{C2}	Control 2	75 x 75
4	RF1	RF switched port 1, DC coupled	100 x 200
5	RF2	RF switched port 2, DC coupled	100 x 200

Assembly Notes

Component placement and adhesive attachment assembly notes:

- Vacuum pencils and/or vacuum collets are the preferred method of pick up.
- Air bridges must be avoided during placement.
- The force impact is critical during auto placement.
- Organic attachment (i.e. epoxy) can be used in low-power applications.
- Curing should be done in a convection oven; proper exhaust is a safety concern.

Reflow process assembly notes:

- Use AuSn (80/20) solder and limit exposure to temperatures above 300°C to 3-4 minutes, maximum.
- An alloy station or conveyor furnace with reducing atmosphere should be used.
- Do not use any kind of flux.
- Coefficient of thermal expansion matching is critical for long-term reliability.
- Devices must be stored in a dry nitrogen atmosphere.

Organic adhesive attachment assembly notes:

- Organic adhesives such as epoxy or polyimide can be used.
- Epoxies cure at temperatures of 100 °C to 200 °C.

Interconnect process assembly notes:

- Thermosonic ball bonding is the preferred interconnect technique.
- Force, time, and ultrasonic conditions are critical parameters.
- Aluminum wire should not be used.
- Devices with small pad sizes should be bonded with 0.0007-inch wire.

Product Compliance Information**ESD Sensitivity Ratings**

Caution! ESD-Sensitive Device

ESD Rating: TBD
Value: TBD
Test: Human Body Model (HBM)
Standard: JEDEC Standard JESD22-A114

ECCN

US Department of Commerce: EAR99

Solderability

Use only AuSn (80/20) solder and limit exposure to temperatures above 300 °C to 3-4 minutes, maximum.

RoHS-Compliance

This part is compliant with EU 2002/95/EC RoHS directive (Restrictions on the Use of Certain Hazardous Substances in Electrical and Electronic Equipment).

This product also has the following attributes:

Lead Free
Halogen Free (Chlorine, Bromine)
Antimony Free
TBBP-A (C15H12Br4O2) Free
PFOS Free
SVHC Free

Contact Information

For the latest specifications, additional product information, worldwide sales and distribution locations, and information about TriQuint:

Web: www.triquint.com
Email: info-sales@tqs.com

Tel: +1.972.994.8465
Fax: +1.972.994.8504

For technical questions and application information: **Email:** info-networks@tqs.com

Important Notice

The information contained herein is believed to be reliable. TriQuint makes no warranties regarding the information contained herein. TriQuint assumes no responsibility or liability whatsoever for any of the information contained herein. TriQuint assumes no responsibility or liability whatsoever for the use of the information contained herein. The information contained herein is provided "AS IS, WHERE IS" and with all faults, and the entire risk associated with such information is entirely with the user. All information contained herein is subject to change without notice. Customers should obtain and verify the latest relevant information before placing orders for TriQuint products. The information contained herein or any use of such information does not grant, explicitly or implicitly, to any party any patent rights, licenses, or any other intellectual property rights, whether with regard to such information itself or anything described by such information.

TriQuint products are not warranted or authorized for use as critical components in medical, life-saving, or life-sustaining applications, or other applications where a failure would reasonably be expected to cause severe personal injury or death.