

Section 3: Molded Case Circuit Breakers

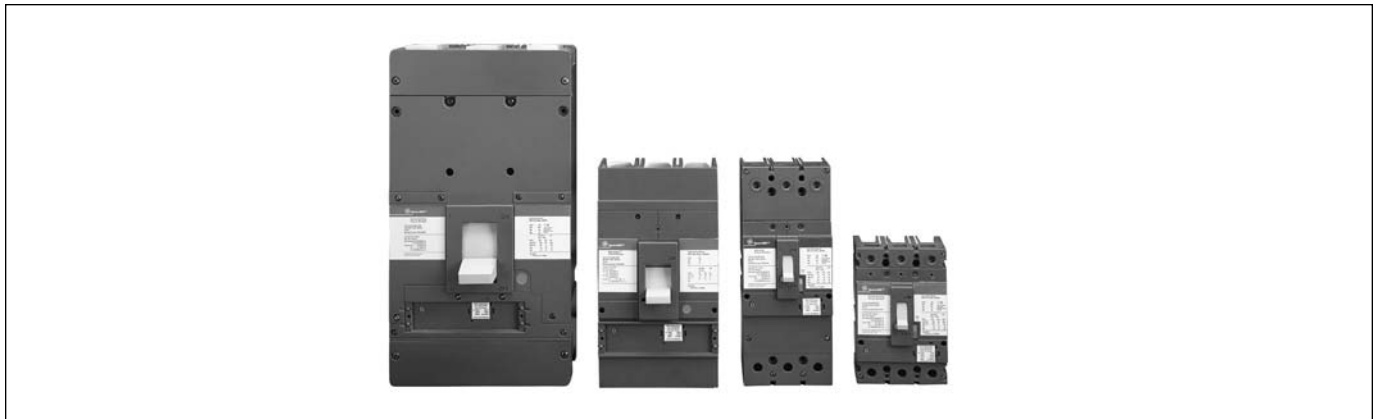

Molded Case Circuit Breakers – Features	3-2	60-600A Circuit Breakers, Electronic Trip, Spectra RMS	3-59
Spectra RMS Circuit Breakers with MicroVersaTrip Plus Trip Units – Features	3-3	60-600A Circuit Breakers, Electronic Trip, Spectra RMS with MicroVersaTrip PM Trip Units	3-59
Molded Case Circuit Breakers – Quick Reference Guide	3-4	125-600A Circuit Breakers, Thermal-Magnetic Trip, J600 Line	3-62
Miniature Circuit Breakers and Supplementary Protectors:		300-1200A Circuit Breakers, Electronic Trip, Spectra RMS	3-64
Plug-in Circuit Breakers – 240V Class	3-5	300-1200A Circuit Breakers, Electronic Trip, Spectra RMS with MicroVersaTrip Plus and PM	3-66
Bolt-on Circuit Breakers – 240V Class	3-12	300-1200A Circuit Breakers, Thermal-Magnetic Trip, K1200 Line	3-69
Bolt-on Circuit Breakers – 480/277V Class	3-17	400-2000A Circuit Breakers, Electronic Trip – R Frame	3-71
Cable-in Cable-out (lug-lug) – 240V Class	3-18	150-1200A Molded Case Switches, Spectra RMS	3-72
DIN-Rail Mount – 240V Class	3-21	3-1200A, Motor Circuit Protectors, Spectra RMS	3-73
Molded Case Switches	3-23	50-1200A, Mine Duty Circuit Breakers, Standard Duty	3-76
E2000 Miniature Circuit Breakers		Replacement Breakers, TriBreak, Internally Fused	3-77
EP60 Series	3-24	Replacement Breakers, THLC Current Limiting, Unfused	3-79
EP100 Series	3-26	Replacement Breakers, J and K Frame Circuit Breakers with MicroVersa Trip Trip Units	3-80
EP100 UC Series	3-28	Replacement Breakers, J and K Frame Circuit Breakers with Power+ 4 Trip Units	3-82
Series CA Auxiliary Switch and Bell Alarm	3-30	Internal Accessories	
Shunt Trip and Undervoltage Release	3-32	Spectra RMS Circuit Breakers	3-83
Technical Data	3-33	Molded Case Circuit Breakers	3-85
Accessories	3-34	Internally Mounted Signaling and Controlling Functions	3-86
Industrial Circuit Breakers—Spectra RMS, Spectra RMS with MicroVersaTrip Plus Trip Units, Spectra RMS with MicroVersaTrip PM Trip Units, Thermal Magnetic and J/K with MicroVersaTrip RMS-9 and Power+ 4 Trip Units:		External Accessories	
How to Order	3-37	Cable Operators	3-92
MicroVersaTrip PM Trip Units – Features	3-40	Handle Operators	3-93
MicroVersaTrip PM Trip Unit Characteristics	3-41	Flange-Mounted Operators	3-94
MicroVersaTrip PM Trip Units – How to Order	3-42	Door-Mounted Operators	3-96
R-Frame Molded Case Circuit Breakers – How to Order	3-43	Motor Operators and Plug-in Hardware	3-98
Electric Trip Spectra RMS Breakers – Quick Reference Guide	3-44	Mechanical Interlocks and Locking Devices	3-99
Electric Trip Spectra RMS Breakers – IEC/JIS Ratings	3-45	Breaker Mounting Hardware and Kits	3-100
Thermal Magnetic Trip – Quick Reference Guide	3-46	Lugs and Associated Hardware	3-101
Molded Case Circuit Breakers – Quick Reference Guide	3-47	Neutral Grounds and Sensors	3-103
15-150A Circuit Breakers, Electronic Trip, Spectra RMS	3-48	Plug-in Hardware	3-104
15-150A Circuit Breakers, Thermal-Magnetic Trip, E150 Line	3-50	R Frame Accessories	3-105
70-250A Circuit Breakers, Electronic Trip, Spectra RMS	3-52	Power Management System Accessories	3-106
70-250A Circuit Breakers, Thermal-Magnetic Trip, F225 Line	3-54	Spectra RMS Accessories – Other	3-109
125-400A Circuit Breakers, Thermal-Magnetic Trip, Q Line	3-55		
125-600A Circuit Breakers, Electronic Trip, Spectra RMS	3-56		

Publications and Reference: See Section 21 for a list of additional product-related publications



Molded Case Circuit Breakers

Features

Spectra RMS Molded Case Circuit Breakers

SE150, SF250, SG600, and SK1200 circuit breaker frames have a digital, solid-state, rms sensing trip system with field installable, front-mounted rating plugs to establish or change the breaker ampere rating. Adjustable instantaneous with tracking short-time is standard on all frames including SE150. The trip system uses digital sampling to determine the rms value of sinusoidal and nonsinusoidal currents.

MicroVersaTrip Plus Trip Units or MicroVersaTrip PM Trip Units

SG600 and SK1200 are optionally available with either MicroVersaTrip Plus or MicroVersaTrip PM trip units which offer expanded functionality in the same space-saving size of standard Spectra RMS breakers. The trip system uses digital sampling to determine the rms value of sinusoidal and nonsinusoidal currents.

MicroVersaTrip Plus Trip Units

MicroVersaTrip Plus trip units utilize a digital, LCD display with a four-button keypad to provide local set-up and readout of trip settings. A 3-phase ammeter and trip indicators are standard, as is a clear plastic cover with provisions for sealing to allow tamper-resistant installation. The trip unit digitally measures the current waveform in each phase to determine the true rms value of the current, regardless of the waveshape.

MicroVersaTrip Plus trip units provide accurate, predictable overload and short-circuit protection for distribution systems that include ac and dc variable speed drives, rectifiers, induction heating, and other loads that cause high harmonic distortion as well as standard circuit. They provide maximum breaker-to-breaker selectivity and custom load protection. Short-time and ground fault functions include the flexibility of coordination with or without an I²t ramp.

MicroVersaTrip PM Trip Unit

The MicroVersaTrip PM trip unit adds power management system capability, advanced metering, and protective relays to the basic functions of the MicroVersaTrip Plus trip unit. The MicroVersaTrip PM trip unit communicates directly on the GE POWER LEADER communication bus.

A complete circuit breaker consists of a UL listed circuit breaker frame and a rating plug (UL listed interchangeable trip unit). Terminal lugs for cable connection are available if required.

- All frames use the same UL listed, field-installable internal accessories (auxiliary switch, shunt trip, undervoltage release and bell alarm).
- All frame sizes have maximum UL listed interrupting ratings of 200 kA @ 240 Vac and 100 kA @ 480 Vac with 600 Vac ratings to 65 kA depending on frame size. UL listed current limiting versions are provided through the SG600 frame for the 65 kA @ 480 Vac and the 100 kA @ 480 Vac models, with no increase in physical frame size.
- Spectra RMS Mag-Break instantaneous-only motor circuit protectors also use the same digital, solid-state trip unit and rating plugs as the circuit breakers. The interchangeable rating plug establish-

es the instantaneous pickup range (with tracking short-time) but does not change the frame ampere rating.

- Spectra RMS molded case switches have a fixed, high-set instantaneous trip (without tracking short-time function) and have short-circuit withstand ratings equal to their equivalent breaker frame size interrupting rating in most cases.
- Spectra RMS breakers are ambient insensitive. Trip times will not vary over the range 10-50°C breaker ambient. Refer to GET-7002 for further application information.
- Spectra RMS breakers contain no parts that would support fungus growth and are, therefore, inherently fungusproof.

Other MCCB Features

- UL489 Listed
- Broad product line to meet virtually any application need.
- Reduced downtime. A tripped breaker is easily spotted and can be immediately reset after the fault has been corrected.
- Eliminates single phasing. A common trip bar disconnects all poles simultaneously on both overloads and short circuits.
- Offers application flexibility through the use of a wide variety of accessory devices and special attachments.
- Repetitive operation—no fuses to replace.
- Breakers can be repetitively tested. Fuses must be destroyed to confirm calibration accuracy.

For more information on these products, order publications listed in Sections 21 and 22.

Reference Publications

Spectra RMS Molded Case Circuit Breakers

GEH-5591	SE150 & SF250
GEH-5663	SG600
	SG600 with MicroVersaTrip Plus and MicroVersaTrip PM Trip Units
GEH-5592	SK1200
	SK1200 with MicroVersaTrip Plus and MicroVersaTrip PM Trip Units
GEH-5934	MicroVersaTrip Plus and MicroVersaTrip PM Trip Units in Spectra RMS Molded Case Circuit Breakers
GEH-5887	Micro-VersaTrip Plus and MicroVersaTrip PM Rating Plugs
GEH-5549	Standard Rating Plugs
GEH-5551	Shunt Trip/UV Release
GEH-5593	Auxiliary Switch/Bell Alarm
GEH-5885	R-Frame Molded Case Circuit Breakers
DEJ-001	TVPBP Portable Battery Pack
GEH-6250	Voltage Module
GEH-6251	Power Supply Plate
GEH-6252	Voltage Conditioner Plate
GEH-6253	Power Supply Assembly
GEH-6254	Voltage Conditioner Assembly
GEH-6255	Distribution Cable Harness
GEH-6256	Distribution Cable Extension
GEH-6257	Distribution Cable Terminal Block
GEH-6258	Distribution Cable Junction Box

NOTE: NEMA ABI (1975) has been superseded by UL489



Spectra RMS Circuit Breakers with MicroVersaTrip Plus Trip Units

Features

MicroVersaTrip Plus Trip Units Standard

- 3-phase Ammeter with $\pm 4\%$ accuracy.
- Adjustable Long Time (L) pickup, 0.5-1.0X, and delay (3-4 bands).
- Adjustable Instantaneous (I) pickup, 1.5-10X.
- Local Overload and Short Circuit Trip Indicators (T) with overload pickup warning.
- Interchangeable trip ratings plugs with test set jack for TVRMS test set.
- Digital LCD display with four-button keypad for function selection and set point adjustment and sealable, clear Lexan cover for tamper-resistant settings.
- True rms sensing for accurate response to high harmonic content waveforms.
- EMI immunity per ANSI C37.90.

Optional

- Adjustable Short-Time (S) pickup, 1.0-9.0C, and delay (4 bands) with I^2t IN/OUT selection.
- Adjustable Ground fault (G) pickup, 0.2-1.0S, and delay (4 bands) with I^2t IN/OUT selection and trip indicator. The 4 short-time and ground fault delay bands provide broader system selectivity.

World Standards—Frames rated to UL, CSA, IEC 947-2, and JIS.

Universal Internal Accessories—Uses the same front-mounted, field installable shunt trips, undervoltage releases, bell alarms, and auxiliary switches as standard Spectra RMS breakers.

Accessory Lead Routing Left or Right—Side channels mean no extra space required for accessory leads.

Current Limiting—SE150, SF250 and SG600 frames rated 65kA and 100kA @ 480 Vac are UL listed as current limiting.

Reverse Feed—Front-mounted interchangeable rating plugs mean all frames are UL listed for reverse feed.



SG Frame with MicroVersaTrip Plus Trip Unit

Wide Current Setting Range—Interchangeable rating plugs combined with 5 current sensors and 0.5-1.0X long time pickup yield ampere ratings from 30 to 1200A.

100% Continuous Current Rated—Optionally available for 100% UL continuous current rating applications.

Control Power 24 Vdc—Optionally available, provides connection capability for +24 Vdc into the breaker via the distribution cable system.

MicroVersaTrip Plus Trip Unit Characteristics¹

Current Setting (C) (Pick-Up) (Multiple of Rating Plug Amperes) (X)	Long-Time ²		Short-Time		Adjustable Instantaneous Pick-Up (Multiple of Rating Plug Amperes) (X)	Ground Fault	
	Delay (Seconds)	Pick-Up (Multiple of Current Setting) (C)	Delay (Seconds)	Pick-Up (Multiple of Sensor Ampere Rating) (X)		Delay (Seconds)	
0.5 to 1.0 in increments of 0.05	2.4, 4.9, 9.8, 20 ^{3,4}	1.5 to 9.0 in increments of 0.5	I^2t in, ⁴ .44	1.5 to 10.0 in increments of 0.5	.20 to 1.00 in increments of .05	I^2t in, ⁵ .41	
			I^2t out, ⁶ .10, .20, .30, .40			I^2t out, ⁶ .10, .20, .30, .40	

X = Rating Plug Amperes

S = Sensor Ampere Rating

C = Long-Time Current Settings (Pick-Up)

¹Contact local GE Sales Office for use on 400 Hz applications. Not UL listed for 400 Hz.

²Pick-up fixed at 1.1C.

³20 second delay (band) not available on SG frames.

⁴Time delay at 600% of current setting at lower limit of each band.

⁵Time delay at 200% of pick-up setting at lower limit of band.

⁶Time delay shown at lower limit of each band. Pick-up tolerances $\pm 10\%$. Ground fault pick-up not to exceed 1200 amperes.

Publications and Reference: See Section 21 for a list of additional product-related publications

Molded Case Circuit Breakers

Quick Reference Guide

Ratings do not apply to molded case switches.

The interruption ratings and voltages shown in the table are maximum ratings. A circuit breaker of the type given in the left-hand column may be applied at the given circuit voltage in any electrical distribution system where the available fault current at the load terminals of the breaker does not exceed the value in the table. That circuit breaker type may also be applied at intermediate values of circuit voltage provided the available fault current at the load terminals of the breaker does not exceed the value in the table for the higher value of voltage.

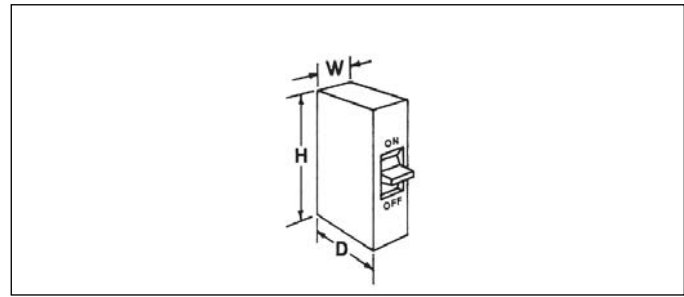

Q Line (UL file E-11592; Fixed Thermal Magnetic Trip Unit)

Circuit Breaker Type	Ampere Rating	No. Poles	Maximum Voltage Rating		UL Listed Interrupting Ratings—rms Symmetrical kA								Dimensions (in.)							Std. Pack					
					Vac				Vdc				H	W	D	A	B	C	E						
					ac	dc	120	120/240	240	277	480	600									125	250			
TQ	15-50	1	120/240	—	—	10	—	—	—	—	—	—	—	3	3/4	2 3/8	—	—	—	—	10				
	15-60	2	120/240	—	—	10	—	—	—	—	—	—	—	3	1 1/2	2 3/8	—	—	—	—	5				
THQP ¹	15-50	1	120/240	—	—	10	—	—	—	—	—	—	—	3 9/32	1/2	2 3/8	—	—	—	—	—	100			
		2													1								50		
TQL/TQB/TQC	10	1	120/240	—	—	5 ²	—	—	—	—	—	—	—	3 9/32	1	2 3/8	—	—	—	—	—	50			
		2													2								25		
		3													3								15		
THQL ¹ THQB ¹ THQC ¹	15-70	1	120/240	—	—	10	—	—	—	—	—	—	—	3 9/32	1	2 3/8	—	—	—	—	—	50			
	15-125	2													10								25		
	15-100	3													10								15		
THHQB ¹ THHQC ¹	15-70	1	120/240	—	—	22	—	—	—	—	—	—	—	3 9/32	1	2 3/8	—	—	—	—	—	50			
	15-100	2													22								25		
		3													22								15		
THHQL ¹	15-70	1	120/240	—	—	22	—	—	—	—	—	—	—	3 9/32	1	2 3/8	—	—	—	—	—	50			
	15-125	2													22								25		
		15-100													3								22	15	
TXQL ¹ TXQB ¹ TXQC ¹	15-30	1	120/240	—	—	65	—	—	—	—	—	—	—	3 9/32	1	2 3/8	—	—	—	—	—	50			
		2													65								25		
		3													—								15		
TQDL	125-200	2	120/240	—	—	10	—	—	—	—	—	—	—	6 1/16	2	2 3/8	—	—	—	—	—	12			
THQDL	125-200	2	120/240	—	—	22	—	—	—	—	—	—	—	6 1/16	2	2 3/8	—	—	—	—	—	12			
TQD ¹	100-225	2	240	—	—	10	10	—	—	—	—	—	—	6 9/16	2 3/4	2 5/8	2 7/16	2 7/16	—	27/32	—	1			
	100-225	3													4 1/8								11/16	1	
THQD ¹	100-225	2	240	—	—	22	22	—	—	—	—	—	—	6 9/16	2 3/4	2 5/8	2 7/16	2 7/16	—	27/32	—	1			
	100-225	3													4 1/8								11/16	1	
TJD	250-400	2	240	—	—	22	22	—	—	—	—	10	10 1/8	8 1/4	3 13/16	3 15/16	3 13/16	1 3/8	1 3/16	—	—	1			
		3																					22	1	
TEY ¹	15-100	1	277	125	65	—	14	14	—	—	10	—	—	5 1/4	1	3 1/16	—	—	—	—	—	—			
		2													250								10	10	2
		3													480/277								—	65	14

CB3 Ground Fault, Equipment Ground Fault and Arc Fault (UL File E-51075; Fixed Thermal Magnetic Trip Unit)

THQB THQC THQL ...GF, GFEP, ...AF	15-30	1	120	—	10	—	—	—	—	—	—	—	—	3 9/32	1	2 3/8	—	—	—	—	—	10
		2													1							
THHQL ...GF THHQB ...GF, GFEP, ...AF	15-30	1	120	—	22	—	—	—	—	—	—	—	—	3 9/32	1	2 3/8	—	—	—	—	—	10

¹ UL listed as HACR (heating, air conditioning and refrigeration).

² Not UL listed.

³ 480Y/277 Vac



MOLDED CASE CIRCUIT BREAKERS

3

Miniature Circuit Breakers and Supplementary Protectors
Plug-in Circuit Breakers
240V Class

TQL and THQL 120/240 Vac **GO-138A**

# of Poles	Ampere Rating	120/240 Vac Interrupting Rating	Wire Range ¹	Product Number	List Price
1	10	5kA		TQL1110	\$20.00
1	15 ²	10kA	(1) 14-8 Cu/12-8 Al	THQL1115	\$20.25
1	20 ²	10kA	(1) 14-8 Cu/12-8 Al	THQL1120	\$20.25
1	25	10kA	(1) 14-8 Cu/12-8 Al	THQL1125	\$20.25
1	30	10kA	(1) 14-8 Cu/12-8 Al	THQL1130	\$20.25
1	35	10kA	(1) 8-3 Cu/8-3 Al	THQL1135	\$21.25
1	40	10kA	(1) 8-3 Cu/8-3 Al	THQL1140	\$21.25
1	45	10kA	(1) 8-3 Cu/8-3 Al	THQL1145	\$21.25
1	50	10kA	(1) 8-3 Cu/8-3 Al	THQL1150	\$21.25
1	60	10kA	(1) 8-3 Cu/8-3 Al	THQL1160	\$21.25
1	70	10kA	(1) 6-1/0 Cu/4-1/0 Al	THQL1170	\$42.50

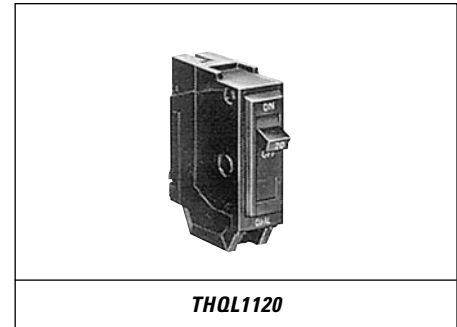

TQL and THQL 120/240 Vac, Internal Common Trip **GO-138A**

# of Poles	Ampere Rating	120/240 Vac Interrupting Rating	Wire Range ¹	Product Number	List Price
2	10 ²	5kA		TQL2110	\$46.00
2	15	10kA	(1) 14-8 Cu/12-8 Al	THQL2115	\$46.00
2	20	10kA	(1) 14-8 Cu/12-8 Al	THQL2120	\$46.00
2	25	10kA	(1) 14-8 Cu/12-8 Al	THQL2125	\$46.00
2	30	10kA	(1) 14-8 Cu/12-8 Al	THQL2130	\$46.00
2	35	10kA	(1) 8-3 Cu/8-3 Al	THQL2135	\$47.75
2	40	10kA	(1) 8-3 Cu/8-3 Al	THQL2140	\$47.75
2	45	10kA	(1) 8-3 Cu/8-3 Al	THQL2145	\$47.75
2	50	10kA	(1) 8-3 Cu/8-3 Al	THQL2150	\$47.75
2	60	10kA	(1) 8-3 Cu/8-3 Al	THQL2160	\$47.75
2	70	10kA	(1) 6-1/0 Cu/4-1/0 Al	THQL2170	\$95.00
2	80	10kA	(1) 6-1/0 Cu/4-1/0 Al	THQL2180	\$131.00
2	90	10kA	(1) 6-1/0 Cu/4-1/0 Al	THQL2190	\$131.00
2	100	10kA	(1) 6-1/0 Cu/4-1/0 Al	THQL21100	\$131.00
2	110	10kA	(1) 2-2/0 Cu/2-2/0 Al	THQL21110	\$284.00
2	125	10kA	(1) 2-2/0 Cu/2-2/0 Al	THQL21125 ³	\$284.00

THQP 120/240 Vac **GO-138A**

# of Poles	Ampere Rating	120/240 Vac Interrupting Rating	Wire Range ¹	Product Number	List Price
1	15	10kA	14-8 Cu/12-8 Al	THQP115	\$20.25
1	20	10kA	14-8 Cu/12-8 Al	THQP120	\$20.25
1	25	10kA	14-8 Cu/12-8 Al	THQP125	\$20.25
1	30	10kA	8-4 Cu/8-4 Al	THQP130	\$20.25
1	35	10kA	8-4 Cu/8-4 Al	THQP135	\$21.25
1	40	10kA	8-4 Cu/8-4 Al	THQP140	\$21.25
1	45	10kA	8-4 Cu/8-4 Al	THQP145	\$21.25
1	50	10kA	8-4 Cu/8-4 Al	THQP150	\$21.25

¹Solid or stranded for 14-10 AWG.

²UL listed as SWD (Switching Duty) rated. Suitable for switching 120 Vac fluorescent lighting loads.

³Recommended for use as main or submain breaker only.

UL listed as HACR (heating, air conditioning and refrigeration).

www.DataSheet4U.com

Publications and Reference: See Section 21 for a list of additional product-related publications



www.DataSheet4U.com

MOLDED CASE CIRCUIT BREAKERS

3

Miniature Circuit Breakers and Supplementary Protectors

Plug-in Circuit Breakers
240V Class

THQP 120/240 Vac, Internal Common Trip **GO-138A**

# of Poles	Ampere Rating	120/240 Vac Interrupting Rating	Wire Range ¹	Product Number	List Price
2	15	10kA	14-8 Cu/12-8 Al	THQP215	\$46.00
2	20	10kA	14-8 Cu/12-8 Al	THQP220	\$46.00
2	25	10kA	14-8 Cu/12-8 Al	THQP225	\$46.00
2	30	10kA	8-4 Cu/8-4 Al	THQP230	\$46.00
2	35	10kA	8-4 Cu/8-4 Al	THQP235	\$47.75
2	40	10kA	8-4 Cu/8-4 Al	THQP240	\$47.75
2	45	10kA	8-4 Cu/8-4 Al	THQP245	\$47.75
2	50	10kA	8-4 Cu/8-4 Al	THQP250	\$47.75

15-100 ampere UL Listed as HACR (heating, air conditioning and refrigeration).



THQP230

TQL and THQL 120/240 Vac, Internal Common Trip **GO-138**

# of Poles	Ampere Rating	120/240 Vac Interrupting Rating	Wire Range ¹	Product Number	List Price
2	10	5kA		TQL22010	\$133.00
2	15	10kA	14-8 Cu/12-8 Al	THQL22015	\$133.00
2	20	10kA	14-8 Cu/12-8 Al	THQL22020	\$133.00
2	25	10kA	14-8 Cu/12-8 Al	THQL22025	\$133.00
2	30	10kA	14-8 Cu/12-8 Al	THQL22030	\$133.00
2	35	10kA	8-3 Cu/8-3 Al	THQL22035	\$133.00
2	40	10kA	8-3 Cu/8-3 Al	THQL22040	\$133.00
2	45	10kA	8-3 Cu/8-3 Al	THQL22045	\$133.00
2	50	10kA	8-3 Cu/8-3 Al	THQL22050	\$133.00
2	60	10kA	8-3 Cu/8-3 Al	THQL22060	\$133.00
2	70	10kA	6-1/0 Cu/4-1/0 Al	THQL22070	\$156.00
2	80	10kA	6-1/0 Cu/4-1/0 Al	THQL22080	\$221.00
2	90	10kA	6-1/0 Cu/4-1/0 Al	THQL22090	\$221.00
2	100	10kA	6-1/0 Cu/4-1/0 Al	THQL22100	\$221.00

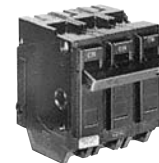

THQL32015

TQL and THQL 240 Vac, Internal Common Trip **GO-138**

# of Poles	Ampere Rating	240 Vac Interrupting Rating	Wire Range ¹	Product Number	List Price
3	10	5kA		TQL32010	\$165.00
3	15	10kA	14-8 Cu/12-8 Al	THQL32015	\$165.00
3	20	10kA	14-8 Cu/12-8 Al	THQL32020	\$165.00
3	25	10kA	14-8 Cu/12-8 Al	THQL32025	\$165.00
3	30	10kA	14-8 Cu/12-8 Al	THQL32030	\$165.00
3	35	10kA	8-3 Cu/8-3 Al	THQL32035	\$165.00
3	40	10kA	8-3 Cu/8-3 Al	THQL32040	\$165.00
3	45	10kA	8-3 Cu/8-3 Al	THQL32045	\$165.00
3	50	10kA	8-3 Cu/8-3 Al	THQL32050	\$165.00
3	60	10kA	8-3 Cu/8-3 Al	THQL32060	\$165.00
3	70	10kA	6-1/0 Cu/4-1/0 Al	THQL32070	\$216.00
3	80	10kA	6-1/0 Cu/4-1/0 Al	THQL32080	\$245.00
3	90	10kA	6-1/0 Cu/4-1/0 Al	THQL32090	\$245.00
3	100	10kA	6-1/0 Cu/4-1/0 Al	THQL32100	\$245.00



THQL1115AF

THQL and THHQL 120/240 Vac Arc Fault **GO-146A**

# of Poles	Ampere Rating	120/240 Vac Interrupting Rating	Wire Range ¹	Product Number	List Price
1	15	10kA	14-10 Cu/14-10 Al	THQL1115AF	\$170.00
1	20	10kA	14-10 Cu/14-10 Al	THQL1120AF	\$170.00
1	15	22kA	14-10 Cu/14-10 Al	THHQL1115AF	\$326.00
1	20	22kA	14-10 Cu/14-10 Al	THHQL1120AF	\$326.00

THQL and THHQL 120/240 Vac Arc Fault **GO-146A**

# of Poles	Ampere Rating	120/240 Vac Interrupting Rating	Wire Range ¹	Product Number	List Price
2	15	10kA	14-10 Cu/14-10 Al	THQL2115AF	\$385.00
2	20	10kA	14-10 Cu/14-10 Al	THQL2120AF	\$385.00
2	15	22kA	14-10 Cu/14-10 Al	THHQL2115AF	\$701.00
2	20	22kA	14-10 Cu/14-10 Al	THHQL2120AF	\$701.00

¹Solid or stranded for 14-10 AWG.



THQL2115AF

MOLDED CASE
CIRCUIT BREAKERS

3



Miniature Circuit Breakers and Supplementary Protectors
Plug-in Circuit Breakers
240V Class

THQL and THHQL 120 Vac, Ground Fault Circuit Interrupters **GO-146**

# of Poles	Ampere Rating	120 Vac Interrupting Rating	Wire Range ¹	Product Number	List Price
1	15	10kA	14-8 Cu/12-8 Al	THQL1115GF	\$159.00
1	20	10kA	14-8 Cu/12-8 Al	THQL1120GF	\$159.00
1	30	10kA	14-8 Cu/12-8 Al	THQL1130GF	\$159.00
1	15	22kA	14-8 Cu/12-8 Al	THHQL1115GF	\$311.00
1	20	22kA	14-8 Cu/12-8 Al	THHQL1120GF	\$311.00
1	30	22kA	14-8 Cu/12-8 Al	THHQL1130GF	\$311.00

THQL and THHQL 120/240 Vac or 208Y/120 Vac, Ground Fault Circuit Interrupters Internal Common Trip **GO-146**

# of Poles	Ampere Rating	120/240 Vac Interrupting Rating	Wire Range ¹	Product Number	List Price
2	15	10kA	14-8 Cu/12-8 Al	THQL2115GF1	\$282.00
2	20	10kA	14-8 Cu/12-8 Al	THQL2120GF1	\$282.00
2	30	10kA	14-8 Cu/12-8 Al	THQL2130GF1	\$282.00
2	40	10kA	8-3 Cu/8-3 Al	THQL2140GF1	\$282.00
2	50	10kA	8-3 Cu/8-3 Al	THQL2150GF1	\$702.00

THQL and THHQL 120 Vac, Equipment Protection Ground Fault Circuit Breakers Internal Common Trip **GO-146**

# of Poles	Ampere Rating	120 Vac Interrupting Rating	Wire Range ¹	Product Number	List Price
1	15	10kA	14-8 Cu/12-8 Al	THQL1115GFEP	\$271.00
1	20	10kA	14-8 Cu/12-8 Al	THQL1120GFEP	\$271.00
1	30	10kA	14-8 Cu/12-8 Al	THQL1130GFEP	\$271.00

THQL and THHQL 120/240 Vac or 208Y/120 Vac, Equipment Protection Ground Fault Circuit Breakers **GO-146**

# of Poles	Ampere Rating	120/240 Vac or 208Y/120 Interrupting Rating	Wire Range ¹	Product Number	List Price
2	15	10kA	14-8 Cu/12-8 Al	THQL2115GFEP	\$481.00
2	20	10kA	14-8 Cu/12-8 Al	THQL2120GFEP	\$481.00
2	30	10kA	14-8 Cu/12-8 Al	THQL2130GFEP	\$481.00

THQL Interlocking—for use in PowerMark Gold Generator Panels **GO-138A**

# of Poles	Ampere Rating	120/240 Vac or 208Y/120 Interrupting Rating	Wire Range ¹	Product Number	List Price
2	30	10kA	14-8 Cu/12-8 Al	THQL2130GEN	\$238.75
2	60	10kA	8-3 Cu/8-3 Al	THQL2160GEN	\$238.75

Two breakers required for interlocking.

TQ Circuit Breakers 120/240 Vac **GO-138Q**

3/4" UL Classified Circuit Breakers for use in Square D QO Load Centers.
 10 kAIC RMS symmetrical.

# of Poles	Ampere Rating	120/240 Vac Interrupting Rating	Wire Range ¹	Product Number	List Price
1	15	10kA	14-8 Cu/12-8 Al	TQ1115	\$20.25
1	20	10kA	14-8 Cu/12-8 Al	TQ1120	\$20.25
1	30	10kA	14-8 Cu/12-8 Al	TQ1130	\$20.25
1	40	10kA	8-2 Cu/8-2 Al	TQ1140	\$20.25
1	50	10kA	8-2 Cu/8-2 Al	TQ1150	\$20.25
2	15	10kA	14-8 Cu/12-8 Al	TQ2115	\$46.00
2	20	10kA	14-8 Cu/12-8 Al	TQ2120	\$46.00
2	30	10kA	14-8 Cu/12-8 Al	TQ2130	\$46.00
2	40	10kA	8-2 Cu/8-2 Al	TQ2140	\$46.00
2	50	10kA	8-2 Cu/8-2 Al	TQ2150	\$46.00
2	60	10kA	8-2 Cu/8-2 Al	TQ2160	\$46.00

¹Solid or stranded for 14-10 AWG.



MOLDED CASE CIRCUIT BREAKERS

3

Publications and Reference: See Section 21 for a list of additional product-related publications



Miniature Circuit Breakers and Supplementary Protectors

Plug-in Circuit Breakers
240V Class

THQL and THHQL 120/240 Vac, High Intensity Discharge Lighting Loads **GO-138A**

# of Poles	Ampere Rating	120/240 Vac Interrupting Rating	Wire Range ¹	Product Number	List Price
1	15	10kA	14-8 Cu/12-8 Al	THQL1115HID ²	\$26.00
1	20	10kA	14-8 Cu/12-8 Al	THQL1120HID ²	\$26.00
1	25	10kA	14-8 Cu/12-8 Al	THQL1125HID	\$26.00
1	30	10kA	14-8 Cu/12-8 Al	THQL1130HID	\$26.00
1	15	22kA	14-8 Cu/12-8 Al	THHQL1115HID ²	\$49.50
1	20	22kA	14-8 Cu/12-8 Al	THHQL1120HID ²	\$49.50
1	25	22kA	14-8 Cu/12-8 Al	THHQL1125HID	\$49.50
1	30	22kA	14-8 Cu/12-8 Al	THHQL1130HID	\$49.50

UL listed as HID.



THQL2120HID

THQL and THHQL 120/240 Vac, Internal Common Trip For High Intensity Discharge Lighting Loads **GO-138A**

# of Poles	Ampere Rating	120/240 Vac Interrupting Rating	Wire Range ¹	Product Number	List Price
2	15	10kA	14-8 Cu/12-8 Al	THQL2115HID	\$57.00
2	20	10kA	14-8 Cu/12-8 Al	THQL2120HID	\$57.00
2	25	10kA	14-8 Cu/12-8 Al	THQL2125HID	\$57.00
2	30	10kA	14-8 Cu/12-8 Al	THQL2130HID	\$57.00
2	15	22kA	14-8 Cu/12-8 Al	THHQL2115HID	\$119.00
2	20	22kA	14-8 Cu/12-8 Al	THHQL2120HID	\$119.00
2	25	22kA	14-8 Cu/12-8 Al	THHQL2125HID	\$119.00
2	30	22kA	14-8 Cu/12-8 Al	THHQL2130HID	\$119.00

UL listed as HID.

THQL 120/240 Vac, High In-Rush Loads **GO-138A**

# of Poles	Ampere Rating	120/240 Vac Interrupting Rating	Wire Range ¹	Product Number	List Price
1	15	10kA	14-8 Cu/12-8 Al	THQL1115HM	\$26.00
1	20	10kA	14-8 Cu/12-8 Al	THQL1120HM	\$26.00
1	25	10kA	14-8 Cu/12-8 Al	THQL1125HM	\$26.00
1	30	10kA	14-8 Cu/12-8 Al	THQL1130HM	\$26.00
1	40	10kA	8-3 Cu/8-3 Al	THQL1140HM	\$26.75
1	50	10kA	8-3 Cu/8-3 Al	THQL1150HM	\$26.75



THQL1120HM

THQL 120 Vac, For Factory Installed Shunt Trip^{3,4} Internal Common Trip **GO-138**

# of Poles	Ampere Rating	120 Vac Interrupting Rating	Wire Range ¹	Product Number	List Price
3	20	10kA	14-8 Cu/12-8 Al	THQL32020ST1	\$273.00

THQL 120/240 Vac, Thermal Magnetic Pole plus Nonautomatic Pole For Switching Neutral **GO-138A**

# of Poles	Ampere Rating	120/240 Vac Interrupting Rating	Wire Range ¹	Product Number	List Price
2	15	10kA	14-8 Cu/12-8 Al	THQL21WY15	\$74.25
2	20	10kA	14-8 Cu/12-8 Al	THQL21WY20	\$74.25
2	25	10kA	14-8 Cu/12-8 Al	THQL21WY25	\$74.25
2	30	10kA	14-8 Cu/12-8 Al	THQL21WY30	\$74.25
3	15	10kA	14-8 Cu/12-8 Al	THQL31WY15	\$111.00
3	20	10kA	14-8 Cu/12-8 Al	THQL31WY20	\$111.00
3	25	10kA	14-8 Cu/12-8 Al	THQL31WY25	\$111.00
3	30	10kA	14-8 Cu/12-8 Al	THQL31WY30	\$111.00

¹Solid or stranded for 14-10 AWG.

²UL listed as SWD (switching duty). Suitable for 120 Vac fluorescent lighting loads.

³For additional shunt trip offerings see page 3-88.

⁴20-60 ampere are UL listed as HACR (heating, air conditioning and refrigeration).

MOLDED CASE CIRCUIT BREAKERS

3



Miniature Circuit Breakers and Supplementary Protectors
Plug-in Circuit Breakers
240V Class

THQMV Top-Feed Main Circuit Breaker Kits for use with 150A-225A PowerMark Gold Load Centers **GO-138M**

# of Poles	Ampere Rating	Interrupting Rating @ System Voltage	Wire Range ¹	Product Number	List Price
2	100	22kA	6-350 Cu/Al	THQMV100	\$259.00
2	125	22kA	6-350 Cu/Al	THQMV125	\$259.00
2	150	22kA	6-350 Cu/Al	THQMV150	\$259.00
2	175	22kA	6-350 Cu/Al	THQMV175	\$259.00
2	200	22kA	6-350 Cu/Al	THQMV200	\$259.00
2	225	22kA	6-350 Cu/Al	THQMV225	\$259.00

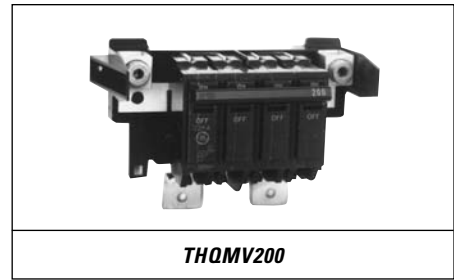

THQMV Bottom-Feed Main Circuit Breaker Kits for use with 150A-225A PowerMark Gold Load Centers Internal Common Trip **GO-138M**

# of Poles	Ampere Rating	Interrupting Rating @ System Voltage	Wire Range ¹	Product Number	List Price
2	100	22kA	6-350 Cu/Al	THQMV100B	\$259.00
2	125	22kA	6-350 Cu/Al	THQMV125B	\$259.00
2	150	22kA	6-350 Cu/Al	THQMV150B	\$259.00
2	175	22kA	6-350 Cu/Al	THQMV175B	\$259.00
2	200	22kA	6-350 Cu/Al	THQMV200B	\$259.00
2	225	22kA	6-350 Cu/Al	THQMV225B	\$259.00

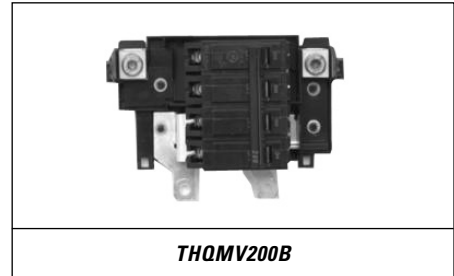

THLK Sub-free and Feed-through Lugs Internal Common Trip **GO-137A**

# of Poles	Ampere Rating	Wire Range ¹	Product Number	List Price
2	125	2-3/0 Cu/Al	THLK2125	\$77.00
3	125	2-3/0 Cu/Al	THLK3125	\$107.00
2	150	2-3/0 Cu/Al	THLK2150 ²	\$137.00
2	200	6-250 Cu/Al	THLK2200 ²	\$158.00
3	225	6-300 Cu/Al	THLK3225 ³	\$250.00



TQDL 120/240 Vac, Internal Common Trip **GO-138A**

# of Poles	Ampere Rating	120/240 Vac Interrupting Rating	Wire Range ¹	Product Number	List Price
2	125	10kA	1/0-250 Cu/Al	TQDL21125	\$296.00
2	150	10kA	1/0-250 Cu/Al	TQDL21150	\$296.00
2	175	10kA	1/0-250 Cu/Al	TQDL21175	\$296.00
2	200	10kA	1/0-250 Cu/Al	TQDL21200	\$296.00



¹Solid or stranded for 14-10 AWG.

²For use with PowerMark Gold load centers only.

³For use with three-phase load centers only. Includes mounting base.

UL listed as HACR (heating, air conditioning and refrigeration). Requires four one-inch spaces.

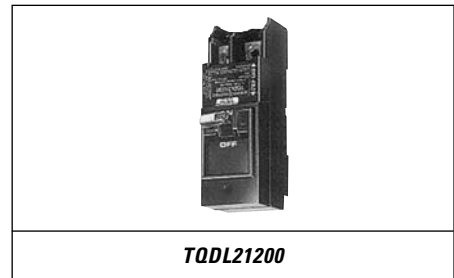

www.DataSheet4U.com

Publications and Reference: See Section 31 for a list of additional product-related publications



MOLDED CASE CIRCUIT BREAKERS 3

Miniature Circuit Breakers and Supplementary Protectors

Plug-in Circuit Breakers
240V Class

THHQL 120 Vac **GO-138A**

# of Poles	Ampere Rating	120 Vac Interrupting Rating	Wire Range ¹	Product Number	List Price
1	15	22kA	14-8 Cu/12-8 Al	THHQL1115 ²	\$40.25
1	20	22kA	14-8 Cu/12-8 Al	THHQL1120 ²	\$40.25
1	25	22kA	14-8 Cu/12-8 Al	THHQL1125	\$40.25
1	30	22kA	8-3 Cu/8-3 Al	THHQL1130	\$40.25
1	35	22kA	8-3 Cu/8-3 Al	THHQL1135	\$41.25
1	40	22kA	8-3 Cu/8-3 Al	THHQL1140	\$41.25
1	45	22kA	8-3 Cu/8-3 Al	THHQL1145	\$41.25
1	50	22kA	8-3 Cu/8-3 Al	THHQL1150	\$41.25
1	60	22kA	8-3 Cu/8-3 Al	THHQL1160	\$41.25
1	70	22kA	6-1/0 Cu/4-1/0 Al	THHQL1170	\$58.50



THHQL 120/240 Vac, Internal Common Trip **GO-138A**

# of Poles	Ampere Rating	120/240 Vac Interrupting Rating	Wire Range ¹	Product Number	List Price
2	15	22kA	14-8 Cu/12-8 Al	THHQL2115	\$93.00
2	20	22kA	14-8 Cu/12-8 Al	THHQL2120	\$93.00
2	25	22kA	14-8 Cu/12-8 Al	THHQL2125	\$93.00
2	30	22kA	8-3 Cu/8-3 Al	THHQL2130	\$93.00
2	35	22kA	8-3 Cu/8-3 Al	THHQL2135	\$97.00
2	40	22kA	8-3 Cu/8-3 Al	THHQL2140	\$97.00
2	45	22kA	8-3 Cu/8-3 Al	THHQL2145	\$97.00
2	50	22kA	8-3 Cu/8-3 Al	THHQL2150	\$97.00
2	60	22kA	8-3 Cu/8-3 Al	THHQL2160	\$97.00
2	70	22kA	6-1/0 Cu/4-1/0 Al	THHQL2170	\$148.00
2	80	22kA	6-1/0 Cu/4-1/0 Al	THHQL2180	\$210.00
2	90	22kA	6-1/0 Cu/4-1/0 Al	THHQL2190	\$210.00
2	100	22kA	6-1/0 Cu/4-1/0 Al	THHQL21100	\$210.00
2	110	22kA	2-2/0 Cu/2-2/0 Al	THHQL21110	\$686.00
2	125	22kA	2-2/0 Cu/2-2/0 Al	THHQL21125	\$686.00

¹Solid or stranded for 14-10 AWG.

²UL listed as SWD (switching duty) rated. Suitable for switching 120 Vac fluorescent lighting loads. UL listed HACR (heating, air conditioning and refrigeration).

MOLDED CASE CIRCUIT BREAKERS

3

www.DataSheet4U.com



Miniature Circuit Breakers and Supplementary Protectors
Plug-in Circuit Breakers
240V Class

THHQL 240 Vac, Internal Common Trip **GO-138**

# of Poles	Ampere Rating	240 Vac Interrupting Rating	Wire Range ¹	Product Number	List Price
2	15	22kA	14-8 Cu/12-8 Al	THHQL22015	\$193.00
2	20	22kA	14-8 Cu/12-8 Al	THHQL22020	\$193.00
2	25	22kA	14-8 Cu/12-8 Al	THHQL22025	\$193.00
2	30	22kA	8-3 Cu/8-3 Al	THHQL22030	\$193.00
2	35	22kA	8-3 Cu/8-3 Al	THHQL22035	\$193.00
2	40	22kA	8-3 Cu/8-3 Al	THHQL22040	\$193.00
2	45	22kA	8-3 Cu/8-3 Al	THHQL22045	\$193.00
2	50	22kA	8-3 Cu/8-3 Al	THHQL22050	\$193.00
2	60	22kA	8-3 Cu/8-3 Al	THHQL22060	\$193.00
2	70	22kA	6-1/0 Cu/4-1/0 Al	THHQL22070	\$251.00
2	80	22kA	6-1/0 Cu/4-1/0 Al	THHQL22080	\$277.00
2	90	22kA	6-1/0 Cu/4-1/0 Al	THHQL22090	\$277.00
2	100	22kA	6-1/0 Cu/4-1/0 Al	THHQL22100	\$277.00
3	15	22kA	14-8 Cu/12-8 Al	THHQL32015	\$251.00
3	20	22kA	14-8 Cu/12-8 Al	THHQL32020	\$251.00
3	25	22kA	14-8 Cu/12-8 Al	THHQL32025	\$251.00
3	30	22kA	8-3 Cu/8-3 Al	THHQL32030	\$251.00
3	35	22kA	8-3 Cu/8-3 Al	THHQL32035	\$251.00
3	40	22kA	8-3 Cu/8-3 Al	THHQL32040	\$251.00
3	45	22kA	8-3 Cu/8-3 Al	THHQL32045	\$251.00
3	50	22kA	8-3 Cu/8-3 Al	THHQL32050	\$251.00
3	60	22kA	8-3 Cu/8-3 Al	THHQL32060	\$251.00
3	70	22kA	6-1/0 Cu/4-1/0 Al	THHQL32070	\$329.00
3	80	22kA	6-1/0 Cu/4-1/0 Al	THHQL32080	\$359.00
3	90	22kA	6-1/0 Cu/4-1/0 Al	THHQL32090	\$359.00
3	100	22kA	6-1/0 Cu/4-1/0 Al	THHQL32100	\$359.00

UL listed HACR (heating, air conditioning and refrigeration).

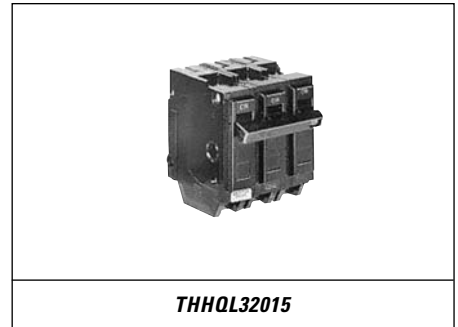

THQDL 120/240 Vac, Internal Common Trip **GO-138**

# of Poles	Ampere Rating	120/240 Vac Interrupting Rating	Wire Range ¹	Product Number	List Price
2	125	22kA	1/0-250 Cu/1/0-250 Al	THQDL21125	\$713.00
2	150	22kA	1/0-250 Cu/1/0-250 Al	THQDL21150	\$713.00
2	175	22kA	1/0-250 Cu/1/0-250 Al	THQDL21175	\$713.00
2	200	22kA	1/0-250 Cu/1/0-250 Al	THQDL21200	\$713.00

TXQL 120/240 Vac **GO-138A**

# of Poles	Ampere Rating	120/240 Vac Interrupting Rating	Wire Range ¹	Product Number	List Price
1	15	65kA	14-8 Cu/12-8 Al	TXQL1115 ²	\$74.75
1	20	65kA	14-8 Cu/12-8 Al	TXQL1120 ²	\$74.75
1	25	65kA	14-8 Cu/12-8 Al	TXQL1125	\$74.75
1	30	65kA	14-8 Cu/12-8 Al	TXQL1130	\$74.75

TXQL 120/240 Vac, Internal Common Trip **GO-138A**

# of Poles	Ampere Rating	120/240 Vac Interrupting Rating	Wire Range ¹	Product Number	List Price
2	15	65kA	14-8 Cu/12-8 Al	TXQL2115	\$186.00
2	20	65kA	14-8 Cu/12-8 Al	TXQL2120	\$186.00
2	25	65kA	14-8 Cu/12-8 Al	TXQL2125	\$186.00
2	30	65kA	14-8 Cu/12-8 Al	TXQL2130	\$186.00
3	15	65kA	14-8 Cu/12-8 Al	TXQL32015	\$348.00
3	20	65kA	14-8 Cu/12-8 Al	TXQL32020	\$348.00
3	25	65kA	14-8 Cu/12-8 Al	TXQL32025	\$348.00
3	30	65kA	14-8 Cu/12-8 Al	TXQL32030	\$348.00

¹ Solid or stranded for 14-10 AWG.

²UL listed as SWD (switching duty) rated. Suitable for switching 120 Vac fluorescent lighting loads.

UL listed HACR (heating, air conditioning and refrigeration).

Publications and Reference: See Section 21 for a list of additional product-related publications



MOLDED CASE CIRCUIT BREAKERS

3

Miniature Circuit Breakers and Supplementary Protectors

Bolt-on Circuit Breakers
240V Class

TQB, THQB 120/240 Vac GO-135B

# of Poles	Ampere Rating	120/240 Vac Interrupting Rating	Wire Range ¹	Product Number	List Price
1	10	5kA	14-8 Cu/12-8 Al	TQB1110	\$19.75
1	15	10kA	14-8 Cu/12-8 Al	THQB1115 ²	\$19.75
1	20	10kA	14-8 Cu/12-8 Al	THQB1120 ²	\$19.75
1	25	10kA	14-8 Cu/12-8 Al	THQB1125	\$19.75
1	30	10kA	14-8 Cu/12-8 Al	THQB1130	\$19.75
1	35	10kA	8-3 Cu/8-3 Al	THQB1135	\$19.75
1	40	10kA	8-3 Cu/8-3 Al	THQB1140	\$19.75
1	45	10kA	8-3 Cu/8-3 Al	THQB1145	\$19.75
1	50	10kA	8-3 Cu/8-3 Al	THQB1150	\$19.75
1	60	10kA	8-3 Cu/8-3 Al	THQB1160	\$19.75
1	70	10kA	6-1/0 Cu/4-1/0 Al	THQB1170	\$38.00

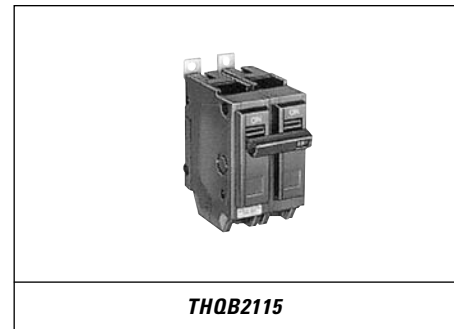

TQB, THQB 120/240 Vac, Internal Common Trip GO-135B

# of Poles	Ampere Rating	120/240 Vac Interrupting Rating	Wire Range ¹	Product Number	List Price
2	10	5kA	14-8 Cu/12-8 Al	TQB2110	\$43.50
2	15	10kA	14-8 Cu/12-8 Al	THQB2115	\$43.50
2	20	10kA	14-8 Cu/12-8 Al	THQB2120	\$43.50
2	25	10kA	14-8 Cu/12-8 Al	THQB2125	\$43.50
2	30	10kA	14-8 Cu/12-8 Al	THQB2130	\$43.50
2	35	10kA	8-3 Cu/8-3 Al	THQB2135	\$43.50
2	40	10kA	8-3 Cu/8-3 Al	THQB2140	\$43.50
2	45	10kA	8-3 Cu/8-3 Al	THQB2145	\$43.50
2	50	10kA	8-3 Cu/8-3 Al	THQB2150	\$43.50
2	60	10kA	8-3 Cu/8-3 Al	THQB2160	\$43.50
2	70	10kA	8-3 Cu/8-3 Al	THQB2170	\$82.50
2	80	10kA	6-1/0 Cu/4-1/0 Al	THQB2180	\$113.00
2	90	10kA	6-1/0 Cu/4-1/0 Al	THQB2190	\$113.00
2	100	10kA	6-1/0 Cu/4-1/0 Al	THQB21100	\$113.00

TQB, THQB 240 Vac, Internal Common Trip GO-135B

# of Poles	Ampere Rating	240 Vac Interrupting Rating	Wire Range ¹	Product Number	List Price
2	10	5kA	14-8 Cu/12-8 Al	TQB22010	\$113.00
2	15	10kA	14-8 Cu/12-8 Al	THQB22015	\$113.00
2	20	10kA	14-8 Cu/12-8 Al	THQB22020	\$113.00
2	25	10kA	14-8 Cu/12-8 Al	THQB22025	\$113.00
2	30	10kA	14-8 Cu/12-8 Al	THQB22030	\$113.00
2	35	10kA	8-3 Cu/8-3 Al	THQB22035	\$113.00
2	40	10kA	8-3 Cu/8-3 Al	THQB22040	\$113.00
2	45	10kA	8-3 Cu/8-3 Al	THQB22045	\$113.00
2	50	10kA	8-3 Cu/8-3 Al	THQB22050	\$113.00
2	60	10kA	8-3 Cu/8-3 Al	THQB22060	\$113.00
2	70	10kA	6-1/0 Cu/4-1/0 Al	THQB22070	\$148.00
2	80	10kA	6-1/0 Cu/4-1/0 Al	THQB22080	\$170.00
2	90	10kA	6-1/0 Cu/4-1/0 Al	THQB22090	\$170.00
2	100	10kA	6-1/0 Cu/4-1/0 Al	THQB22100	\$170.00
3	10	5kA	14-8 Cu/12-8 Al	TQB32010 ³	\$139.00
3	15	10kA	14-8 Cu/12-8 Al	THQB32015	\$139.00
3	20	10kA	14-8 Cu/12-8 Al	THQB32020	\$139.00
3	25	10kA	14-8 Cu/12-8 Al	THQB32025	\$139.00
3	30	10kA	14-8 Cu/12-8 Al	THQB32030	\$139.00
3	35	10kA	8-3 Cu/8-3 Al	THQB32035	\$139.00
3	40	10kA	8-3 Cu/8-3 Al	THQB32040	\$139.00
3	45	10kA	8-3 Cu/8-3 Al	THQB32045	\$139.00
3	50	10kA	8-3 Cu/8-3 Al	THQB32050	\$139.00
3	60	10kA	8-3 Cu/8-3 Al	THQB32060	\$139.00
3	70	10kA	6-1/0 Cu/4-1/0 Al	THQB32070	\$175.00
3	80	10kA	6-1/0 Cu/4-1/0 Al	THQB32080	\$199.00
3	90	10kA	6-1/0 Cu/4-1/0 Al	THQB32090	\$199.00
3	100	10kA	6-1/0 Cu/4-1/0 Al	THQB32100	\$199.00

¹Solid or stranded for 14-10 AWG.

²UL listed as SWD (Switching Duty) rated. Suitable for switching 120 Vac fluorescent lighting loads.

³Not UL listed.

UL listed HACR (heating, air conditioning and refrigeration).

MOLDED CASE
CIRCUIT BREAKERS

3



Miniature Circuit Breakers and Supplementary Protectors
Bolt-on Circuit Breakers
240V Class

THQB, THHQB 120 Vac, Ground Fault Breakers **GO-133**

# of Poles	Ampere Rating	120 Vac Interrupting Rating	Wire Range ¹	Product Number	List Price
1	15	10kA	14-8 Cu/12-8 Al	THQB1115GF	\$120.00
1	20	10kA	14-8 Cu/12-8 Al	THQB1120GF	\$120.00
1	30	10kA	14-8 Cu/12-8 Al	THQB1130GF	\$120.00
1	15	22kA	14-8 Cu/12-8 Al	THHQB1115GF	\$235.00
1	20	22kA	14-8 Cu/12-8 Al	THHQB1120GF	\$235.00
1	30	22kA	14-8 Cu/12-8 Al	THHQB1130GF	\$235.00

THQB 120/240 or 208Y/120 Vac, Ground Fault Breakers, Internal Common Trip **GO-133**

# of Poles	Ampere Rating	120/240 or 208Y/120 Vac Interrupting Rating	Wire Range ¹	Product Number	List Price
2	15	10kA	14-8 Cu/12-8 Al	THQB2115GF	\$212.00
2	20	10kA	14-8 Cu/12-8 Al	THQB2120GF	\$212.00
2	30	10kA	14-8 Cu/12-8 Al	THQB2130GF	\$212.00

THQB 120 Vac, Equipment Protection Ground Fault Circuit Breakers (30 ma) **GO-133**

# of Poles	Ampere Rating	120 Vac Interrupting Rating	Wire Range ¹	Product Number	List Price
1	15	10kA	14-8 Cu/12-8 Al	THQB1115GFEP	\$205.00
1	20	10kA	14-8 Cu/12-8 Al	THQB1120GFEP	\$205.00
1	30	10kA	14-8 Cu/12-8 Al	THQB1130GFEP	\$205.00

THQB 120/240 or 208Y/120 Vac, Ground Fault Breakers Equipment Protection Ground Fault Circuit Breakers, Internal Common Trip **GO-133**

# of Poles	Ampere Rating	120/240 or 208Y/120 Vac Interrupting Rating	Wire Range ¹	Product Number	List Price
2	15	10kA	14-8 Cu/12-8 Al	THQB2115GFEP	\$273.00
2	20	10kA	14-8 Cu/12-8 Al	THQB2120GFEP	\$273.00
2	30	10kA	14-8 Cu/12-8 Al	THQB2130GFEP	\$273.00

THQB 120/240 Vac, High Intensity Discharge Lighting Loads **GO-135B**

# of Poles	Ampere Rating	120/240 Vac Interrupting Rating	Wire Range ¹	Product Number	List Price
1	15	10kA	14-8 Cu/12-8 Al	THQB1115HID ²	\$23.75
1	20	10kA	14-8 Cu/12-8 Al	THQB1120HID ²	\$23.75
1	25	10kA	14-8 Cu/12-8 Al	THQB1125HID	\$23.75
1	30	10kA	14-8 Cu/12-8 Al	THQB1130HID	\$23.75

UL listed as HID (high intensity discharge).

THHQB 120/240 Vac, High Intensity Discharge Lighting Loads **GO-135B**

# of Poles	Ampere Rating	120/240 Vac Interrupting Rating	Wire Range ¹	Product Number	List Price
1	15	22kA	14-8 Cu/12-8 Al	THHQB1115HID ²	\$41.50
1	20	22kA	14-8 Cu/12-8 Al	THHQB1120HID ²	\$41.50
1	25	22kA	14-8 Cu/12-8 Al	THHQB1125HID	\$47.00
1	30	22kA	14-8 Cu/12-8 Al	THHQB1130HID	\$47.00

¹Solid or stranded for 14-10 AWG.

²UL listed as SWD (switching duty). Suitable for switching 120 Vac fluorescent lighting loads.
 UL listed as HID (high intensity discharge).

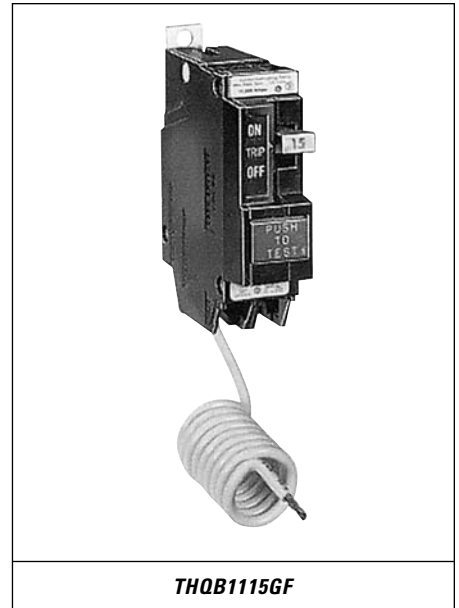

THQB1115GF

MOLDED CASE CIRCUIT BREAKERS

3

Publications and Reference: See Section 21 for a list of additional product-related publications



Miniature Circuit Breakers and Supplementary Protectors

Bolt-on Circuit Breakers

240V Class

THQB 120/240 Vac, Internal Common Trip, High Intensity Discharge

Lighting Loads

GO-135B

# of Poles	Ampere Rating	120/240 Vac Interrupting Rating	Wire Range ¹	Product Number	List Price
2	15	10kA	14-8 Cu/12-8 Al	THQB2115HID	\$52.50
2	20	10kA	14-8 Cu/12-8 Al	THQB2120HID	\$52.50
2	25	10kA	14-8 Cu/12-8 Al	THQB2125HID	\$52.50
2	30	10kA	14-8 Cu/12-8 Al	THQB2130HID	\$52.50

UL listed as HID

THHQB 120/240 Vac, Internal Common Trip, High Intensity Discharge

Lighting Loads

GO-135B

# of Poles	Ampere Rating	120/240 Vac Interrupting Rating	Wire Range ¹	Product Number	List Price
2	15	22kA	14-8 Cu/12-8 Al	THHQB2115HID	\$98.50
2	20	22kA	14-8 Cu/12-8 Al	THHQB2120HID	\$98.50
2	25	22kA	14-8 Cu/12-8 Al	THHQB2125HID	\$98.50
2	30	22kA	14-8 Cu/12-8 Al	THHQB2130HID	\$98.50

UL listed as HID

THQB 120 Vac with Factory Installed 120 Vac Shunt Trip^{2,3}

GO-135B

# of Poles	Ampere Rating	120 Vac Interrupting Rating	Wire Range ¹	Product Number	List Price
1	20	10kA	14-8 Cu/12-8 Al	THQB1120ST1	\$113.00

THQB 120 Vac, Internal Common Trip with Factory Installed 120 Vac Shunt Trip^{2,3}

GO-135B

# of Poles	Ampere Rating	120 Vac Interrupting Rating	Wire Range ¹	Product Number	List Price
2	20	10kA	14-8 Cu/12-8 Al	THQB2120ST1	\$137.00
2	30	10kA	14-8 Cu/12-8 Al	THQB2130ST1	\$137.00
2	100	10kA	6-1/0 Cu/4-1/0 Al	THQB21100ST1	\$205.00
3	20	10kA	14-8 Cu/12-8 Al	THQB32020ST1	\$234.00
3	30	10kA	14-8 Cu/12-8 Al	THQB32030ST1	\$234.00
3	40	10kA	8-3 Cu/8-3 Al	THQB32040ST1	\$234.00
3	50	10kA	8-3 Cu/8-3 Al	THQB32050ST1	\$234.00
3	60	10kA	8-3 Cu/8-3 Al	THQB32060ST1	\$234.00
3	70	10kA	6-1/0 Cu/4-1/0 Al	THQB32070ST1	\$270.00
3	80	10kA	6-1/0 Cu/4-1/0 Al	THQB32080ST1	\$295.00
3	90	10kA	6-1/0 Cu/4-1/0 Al	THQB32090ST1	\$295.00
3	100	10kA	6-1/0 Cu/4-1/0 Al	THQB32100ST1	\$295.00

THQB 120 Vac with Switching Neutral Single Thermal Magnetic Pole;

Single Nonautomatic Pole

GO-138A

# of Poles	Ampere Rating	120 Vac Interrupting Rating	Wire Range ¹	Product Number	List Price
2	15	10kA	14-8 Cu/12-8 Al	THQB21WY15	\$58.50
2	20	10kA	14-8 Cu/12-8 Al	THQB21WY20	\$58.50
2	25	10kA	14-8 Cu/12-8 Al	THQB21WY25	\$58.50
2	30	10kA	14-8 Cu/12-8 Al	THQB21WY30	\$58.50

THQB 120 Vac with Switching Neutral Two Thermal Magnetic Pole;

Single Nonautomatic Pole

GO-135B

# of Poles	Ampere Rating	120 Vac Interrupting Rating	Wire Range ¹	Product Number	List Price
3	15	10kA	14-8 Cu/12-8 Al	THQB31WY15	\$88.00
3	20	10kA	14-8 Cu/12-8 Al	THQB31WY20	\$88.00
3	25	10kA	14-8 Cu/12-8 Al	THQB31WY25	\$88.00
3	30	10kA	14-8 Cu/12-8 Al	THQB31WY30	\$88.00

¹Solid or stranded for 14-10 AWG.

²For additional shunt trip offerings see page 3-88.

³20-60 ampere are UL listed as HACR (heating, air conditioning and refrigeration).

MOLDED CASE
CIRCUIT BREAKERS

3



Miniature Circuit Breakers and Supplementary Protectors
Bolt-on Circuit Breakers
240V Class

THHQB 120/240 Vac **GO-135B**

# of Poles	Ampere Rating	120/240 Vac Interrupting Rating	Wire Range ¹	Product Number	List Price
1	15	22kA	14-8 Cu/12-8 Al	THHQB1115 ²	\$35.00
1	20	22kA	14-8 Cu/12-8 Al	THHQB1120 ²	\$35.00
1	25	22kA	14-8 Cu/12-8 Al	THHQB1125	\$39.00
1	30	22kA	14-8 Cu/12-8 Al	THHQB1130	\$39.00
1	35	22kA	8-3 Cu/8-3 Al	THHQB1135	\$39.00
1	40	22kA	8-3 Cu/8-3 Al	THHQB1140	\$39.00
1	45	22kA	8-3 Cu/8-3 Al	THHQB1145	\$39.00
1	50	22kA	8-3 Cu/8-3 Al	THHQB1150	\$39.00
1	60	22kA	8-3 Cu/8-3 Al	THHQB1160	\$39.00
1	70	22kA	6-1/0 Cu/4-1/0 Al	THHQB1170	\$51.00

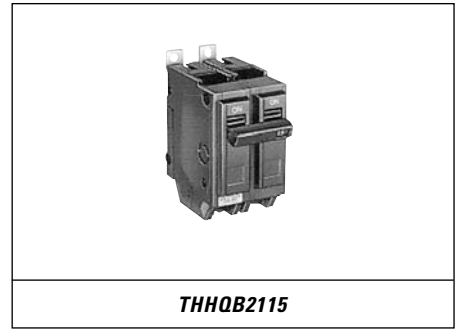

THHQB 120/240 Vac, Internal Common Trip **GO-135B**

# of Poles	Ampere Rating	120/240 Vac Interrupting Rating	Wire Range ¹	Product Number	List Price
2	15	22kA	14-8 Cu/12-8 Al	THHQB2115	\$82.50
2	20	22kA	14-8 Cu/12-8 Al	THHQB2120	\$82.50
2	25	22kA	14-8 Cu/12-8 Al	THHQB2125	\$82.50
2	30	22kA	14-8 Cu/12-8 Al	THHQB2130	\$82.50
2	35	22kA	8-3 Cu/8-3 Al	THHQB2135	\$82.50
2	40	22kA	8-3 Cu/8-3 Al	THHQB2140	\$82.50
2	45	22kA	8-3 Cu/8-3 Al	THHQB2145	\$82.50
2	50	22kA	8-3 Cu/8-3 Al	THHQB2150	\$82.50
2	60	22kA	8-3 Cu/8-3 Al	THHQB2160	\$82.50
2	70	22kA	6-1/0 Cu/4-1/0 Al	THHQB2170	\$126.00
2	80	22kA	6-1/0 Cu/4-1/0 Al	THHQB2180	\$183.00
2	90	22kA	6-1/0 Cu/4-1/0 Al	THHQB2190	\$183.00
2	100	22kA	6-1/0 Cu/4-1/0 Al	THHQB21100	\$183.00

THHQB 240 Vac, Internal Common Trip **GO-135B**

# of Poles	Ampere Rating	240 Vac Interrupting Rating	Wire Range ¹	Product Number	List Price
2	15	22kA	14-8 Cu/12-8 Al	THHQB22015	\$156.00
2	20	22kA	14-8 Cu/12-8 Al	THHQB22020	\$156.00
2	25	22kA	14-8 Cu/12-8 Al	THHQB22025	\$156.00
2	30	22kA	14-8 Cu/12-8 Al	THHQB22030	\$156.00
2	35	22kA	8-3 Cu/8-3 Al	THHQB22035	\$156.00
2	40	22kA	8-3 Cu/8-3 Al	THHQB22040	\$156.00
2	45	22kA	8-3 Cu/8-3 Al	THHQB22045	\$156.00
2	50	22kA	8-3 Cu/8-3 Al	THHQB22050	\$156.00
2	60	22kA	8-3 Cu/8-3 Al	THHQB22060	\$156.00
2	70	22kA	6-1/0 Cu/4-1/0 Al	THHQB22070	\$196.00
2	80	22kA	6-1/0 Cu/4-1/0 Al	THHQB22080	\$235.00
2	90	22kA	6-1/0 Cu/4-1/0 Al	THHQB22090	\$235.00
2	100	22kA	6-1/0 Cu/4-1/0 Al	THHQB22100	\$235.00
3	15	22kA	14-8 Cu/12-8 Al	THHQB32015	\$212.00
3	20	22kA	14-8 Cu/12-8 Al	THHQB32020	\$212.00
3	25	22kA	14-8 Cu/12-8 Al	THHQB32025	\$212.00
3	30	22kA	14-8 Cu/12-8 Al	THHQB32030	\$212.00
3	35	22kA	8-3 Cu/8-3 Al	THHQB32035	\$212.00
3	40	22kA	8-3 Cu/8-3 Al	THHQB32040	\$212.00
3	45	22kA	8-3 Cu/8-3 Al	THHQB32045	\$212.00
3	50	22kA	8-3 Cu/8-3 Al	THHQB32050	\$212.00
3	60	22kA	8-3 Cu/8-3 Al	THHQB32060	\$212.00
3	70	22kA	6-1/0 Cu/4-1/0 Al	THHQB32070	\$263.00
3	80	22kA	6-1/0 Cu/4-1/0 Al	THHQB32080	\$307.00
3	90	22kA	6-1/0 Cu/4-1/0 Al	THHQB32090	\$307.00
3	100	22kA	6-1/0 Cu/4-1/0 Al	THHQB32100	\$307.00

¹Solid or stranded for 14-10 AWG.

²UL listed as SWD (switching duty). Suitable for switching 120 Vac fluorescent lighting loads. UL listed HACR (heating, air conditioning and refrigeration).

www.DataSheet4U.com

Publications and Reference: See Section 31 for a list of additional product-related publications



www.DataSheet4U.com

MOLDED CASE CIRCUIT BREAKERS

3

Miniature Circuit Breakers and Supplementary Protectors

Bolt-on Circuit Breakers

240V Class

TXQB 120/240 Vac GO-135B

# of Poles	Ampere Rating	120/240 Vac Interrupting Rating	Wire Range ¹	Product Number	List Price
1	15	65kA	14-8 Cu/12-8 Al	TXQB1115 ²	\$63.50
1	20	65kA	14-8 Cu/12-8 Al	TXQB1120 ²	\$63.50
1	25	65kA	14-8 Cu/12-8 Al	TXQB1125	\$63.50
1	30	65kA	14-8 Cu/12-8 Al	TXQB1130	\$63.50

TXQB 120/240 Vac, Internal Common Trip GO-135B

# of Poles	Ampere Rating	120/240 Vac Interrupting Rating	Wire Range ¹	Product Number	List Price
2	15	65kA	14-8 Cu/12-8 Al	TXQB2115	\$154.00
2	20	65kA	14-8 Cu/12-8 Al	TXQB2120	\$154.00
2	25	65kA	14-8 Cu/12-8 Al	TXQB2125	\$154.00
2	30	65kA	14-8 Cu/12-8 Al	TXQB2130	\$154.00

TXQB 240 Vac, Internal Common Trip GO-135B

# of Poles	Ampere Rating	240 Vac Interrupting Rating	Wire Range ¹	Product Number	List Price
3	15	65kA	14-8 Cu/12-8 Al	TXQB32015	\$263.00
3	20	65kA	14-8 Cu/12-8 Al	TXQB32020	\$263.00
3	25	65kA	14-8 Cu/12-8 Al	TXQB32025	\$263.00
3	30	65kA	14-8 Cu/12-8 Al	TXQB32030	\$263.00

¹Solid or stranded for 14-10 AWG.

²UL listed as SWD (switching duty) rated. Suitable for switching 120 Vac fluorescent lighting loads.

UL listed HACR (heating, air conditioning and refrigeration).

www.DataSheet4U.com



Miniature Circuit Breakers and Supplementary Protectors

Bolt-on Circuit Breakers
480Y/277V Class

The TEY is a one-inch wide per pole, compact, "bolt-on" circuit breaker for use on grounded 480Y/277 Vac systems. The bolt-on mounting base, shown in the accessory table on page 3-34, makes the TEY suitable for various applications as a lug-lug breaker.

TEY 1 pole 65kA @120 Vac; 14kA @120/240, 240, 277 Vac GO-135B

# of Poles	Ampere Rating	Wire Range ¹	Product Number	List Price
1	15	14-12 Cu/12-10 Al	TEY115 ^{2,3}	\$72.00
1	20	14-12 Cu/12-10 Al	TEY120 ^{2,3}	\$72.00
1	25	14-12 Cu/12-10 Al	TEY125 ³	\$72.00
1	30	14-10 Cu/14-10 Al	TEY130 ³	\$72.00
1	35	14-10 Cu/14-10 Al	TEY135 ³	\$72.00
1	40	14-10 Cu/14-10 Al	TEY140 ³	\$72.00
1	45	14-10 Cu/14-10 Al	TEY145 ³	\$72.00
1	50	14-10 Cu/14-10 Al	TEY150 ³	\$72.00
1	60	14-10 Cu/14-10 Al	TEY160	\$72.00
1	70	4-1 Cu/2-1/0 Al	TEY170	\$142.00
1	80	4-1 Cu/2-1/0 Al	TEY180	\$142.00
1	90	4-1 Cu/2-1/0 Al	TEY190	\$142.00
1	100	4-1 Cu/2-1/0 Al	TEY1100	\$142.00

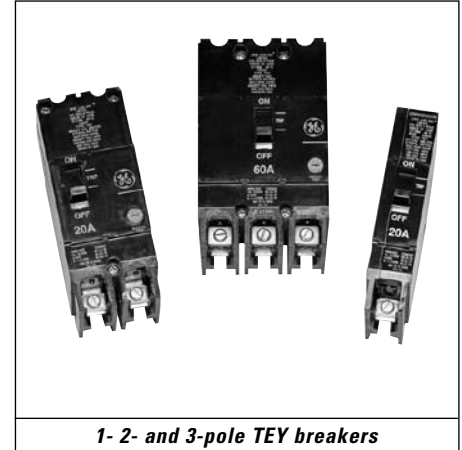

1- 2- and 3-pole TEY breakers

TEY 2 pole 65kA @120, 120/240, 240 Vac; 14kA @277 Vac GO-135B

# of Poles	Ampere Rating	Wire Range ¹	Product Number	List Price
2	15	14-12 Cu/12-10 Al	TEY215 ³	\$216.00
2	20	14-12 Cu/12-10 Al	TEY220 ³	\$216.00
2	25	14-12 Cu/12-10 Al	TEY225 ³	\$216.00
2	30	14-10 Cu/14-10 Al	TEY230 ³	\$216.00
2	35	14-12 Cu/12-10 Al	TEY235 ³	\$216.00
2	40	14-10 Cu/14-10 Al	TEY240 ³	\$216.00
2	45	14-12 Cu/12-10 Al	TEY245 ³	\$216.00
2	50	14-10 Cu/14-10 Al	TEY250 ³	\$216.00
2	60	14-10 Cu/14-10 Al	TEY260	\$216.00
2	70	4-1 Cu/2-1/0 Al	TEY270	\$352.00
2	80	4-1 Cu/2-1/0 Al	TEY280	\$352.00
2	90	4-1 Cu/2-1/0 Al	TEY290	\$352.00
2	100	4-1 Cu/2-1/0 Al	TEY2100	\$352.00

TEY 3 pole 65kA @120, 120/240, 240 Vac; 14kA @277 Vac GO-135B

# of Poles	Ampere Rating	Wire Range ¹	Product Number	List Price
3	15	14-12 Cu/12-10 Al	TEY315 ³	\$316.00
3	20	14-12 Cu/12-10 Al	TEY320 ³	\$316.00
3	25	14-12 Cu/12-10 Al	TEY325 ³	\$316.00
3	30	14-10 Cu/14-10 Al	TEY330 ³	\$316.00
3	35	14-12 Cu/12-10 Al	TEY335 ³	\$316.00
3	40	14-10 Cu/14-10 Al	TEY340 ³	\$316.00
3	45	14-12 Cu/12-10 Al	TEY345 ³	\$316.00
3	50	14-10 Cu/14-10 Al	TEY350 ³	\$316.00
3	60	14-10 Cu/14-10 Al	TEY360	\$316.00
3	70	4-1 Cu/2-1/0 Al	TEY370	\$424.00
3	80	4-1 Cu/2-1/0 Al	TEY380	\$424.00
3	90	4-1 Cu/2-1/0 Al	TEY390	\$424.00
3	100	4-1 Cu/2-1/0 Al	TEY3100	\$424.00

¹Solid or stranded for 14-10 AWG.

²Single-pole, 15 and 20 ampere breakers are also UL listed as switching duty breakers, suitable for switching 120, 240, or 277 Vac.

³UL listed HID (high intensity discharge).

Publications and Reference: See Section 21 for a list of additional product-related publications

MOLDED CASE CIRCUIT BREAKERS

3

Miniature Circuit Breakers and Supplementary Protectors

Cable-in Cable-out (lug-lug)
240V Class

TQC, THQC 120/240 Vac GO-135B

# of Poles	Ampere Rating	120/240 Vac Interrupting Rating	Wire Range ¹	Product Number ²	List Price
1	10	5kA	14-4 Cu/12-2 Al	TQC1110WL	\$20.25
1	15	10kA	14-8 Cu/12-8 Al	THQC1115WL ^{3,4}	\$20.25
1	20	10kA	14-8 Cu/12-8 Al	THQC1120WL ^{3,4}	\$20.25
1	25	10kA	14-8 Cu/12-8 Al	THQC1125WL ³	\$20.25
1	30	10kA	14-8 Cu/12-8 Al	THQC1130WL ³	\$20.25
1	35	10kA	8-3 Cu/8-3 Al	THQC1135WL ³	\$20.25
1	40	10kA	8-3 Cu/8-3 Al	THQC1140WL ³	\$20.25
1	45	10kA	8-3 Cu/8-3 Al	THQC1145WL ³	\$20.25
1	50	10kA	8-3 Cu/8-3 Al	THQC1150WL ³	\$20.25
1	60	10kA	8-3 Cu/8-3 Al	THQC1160WL ³	\$20.25
1	70	10kA	6-1/0 Cu/4-1/0 Al	THQC1170WL	\$39.00

TQC, THQC 120/240 Vac, Internal Common Trip GO-135B

# of Poles	Ampere Rating	120/240 Vac Interrupting Rating	Wire Range ¹	Product Number ²	List Price
2	10	5kA	14-4 Cu/12-2 Al	TQC2110WL	\$46.50
2	15	10kA	14-8 Cu/12-8 Al	THQC2115WL ³	\$43.50
2	20	10kA	14-8 Cu/12-8 Al	THQC2120WL ³	\$43.50
2	25	10kA	14-8 Cu/12-8 Al	THQC2125WL ³	\$43.50
2	30	10kA	14-8 Cu/12-8 Al	THQC2130WL ³	\$43.50
2	35	10kA	8-3 Cu/8-3 Al	THQC2135WL ³	\$43.50
2	40	10kA	8-3 Cu/8-3 Al	THQC2140WL ³	\$43.50
2	45	10kA	8-3 Cu/8-3 Al	THQC2145WL ³	\$43.50
2	50	10kA	8-3 Cu/8-3 Al	THQC2150WL ³	\$43.50
2	60	10kA	8-3 Cu/8-3 Al	THQC2160WL ³	\$43.50
2	70	10kA	6-1/0 Cu/4-1/0 Al	THQC2170WL	\$83.50
2	80	10kA	6-1/0 Cu/4-1/0 Al	THQC2180WL	\$116.00
2	90	10kA	6-1/0 Cu/4-1/0 Al	THQC2190WL	\$116.00
2	100	10kA	6-1/0 Cu/4-1/0 Al	THQC21100WL	\$116.00

TQC, THQC 240 Vac, Internal Common Trip GO-135B

# of Poles	Ampere Rating	240 Vac Interrupting Rating	Wire Range ¹	Product Number ²	List Price
2	10	5kA	14-4 Cu/12-2 Al	TQC22010WL	\$116.00
2	15	10kA	14-8 Cu/12-8 Al	THQC22015WL	\$116.00
2	20	10kA	14-8 Cu/12-8 Al	THQC22020WL	\$116.00
2	25	10kA	14-8 Cu/12-8 Al	THQC22025WL	\$116.00
2	30	10kA	14-8 Cu/12-8 Al	THQC22030WL	\$116.00
2	35	10kA	8-3 Cu/8-3 Al	THQC22035WL	\$116.00
2	40	10kA	8-3 Cu/8-3 Al	THQC22040WL	\$116.00
2	45	10kA	8-3 Cu/8-3 Al	THQC22045WL	\$116.00
2	50	10kA	8-3 Cu/8-3 Al	THQC22050WL	\$116.00
2	60	10kA	8-3 Cu/8-3 Al	THQC22060WL	\$116.00
2	70	10kA	6-1/0 Cu/4-1/0 Al	THQC22070WL	\$152.00
2	80	10kA	6-1/0 Cu/4-1/0 Al	THQC22080WL	\$173.00
2	90	10kA	6-1/0 Cu/4-1/0 Al	THQC22090WL	\$173.00
2	100	10kA	6-1/0 Cu/4-1/0 Al	THQC22100WL	\$173.00
3	10	5kA	14-4 Cu/12-2 Al	TQC32010WL	\$141.00
3	15	10kA	14-8 Cu/12-8 Al	THQC32015WL	\$141.00
3	20	10kA	14-8 Cu/12-8 Al	THQC32020WL	\$141.00
3	25	10kA	14-8 Cu/12-8 Al	THQC32025WL	\$141.00
3	30	10kA	14-8 Cu/12-8 Al	THQC32030WL	\$141.00
3	35	10kA	8-3 Cu/8-3 Al	THQC32035WL	\$141.00
3	40	10kA	8-3 Cu/8-3 Al	THQC32040WL	\$141.00
3	45	10kA	8-3 Cu/8-3 Al	THQC32045WL	\$141.00
3	50	10kA	8-3 Cu/8-3 Al	THQC32050WL	\$141.00
3	60	10kA	8-3 Cu/8-3 Al	THQC32060WL	\$141.00
3	70	10kA	6-1/0 Cu/4-1/0 Al	THQC32070WL	\$178.00
3	80	10kA	6-1/0 Cu/4-1/0 Al	THQC32080WL	\$202.00
3	90	10kA	6-1/0 Cu/4-1/0 Al	THQC32090WL	\$202.00
3	100	10kA	6-1/0 Cu/4-1/0 Al	THQC32100WL	\$202.00

¹Solid or stranded for 14-10 AWG.

²Use additional suffix "BP" (THQC32020WLBP) for bulk pack of 48 poles. Carton weight 20 lbs. 15-60 ampere breakers only.

³Suitable for mounting on standard 35mm DIN Rail. Refer to table on page 3-21 for termination options.

⁴UL listed as SWD (switching duty) rated. Suitable for switching 120 Vac fluorescent lighting loads.

UL listed HACR (heating, air conditioning and refrigeration). Refer to Q Line accessories listed on pages 3-34 to 3-36.

MOLDED CASE CIRCUIT BREAKERS

3



Miniature Circuit Breakers and Supplementary Protectors

Cable-in Cable-out (lug-lug)

240V Class

THQC 120 Vac, Ground Fault Circuit Interrupter GO-133

# of Poles	Ampere Rating	120 Vac Interrupting Rating	Wire Range ¹	Product Number	List Price
1	15	10kA	14-8 Cu/12-8 Al	THQC1115GF ²	\$128.00
1	20	10kA	14-8 Cu/12-8 Al	THQC1120GF ²	\$128.00
1	30	10kA	14-8 Cu/12-8 Al	THQC1130GF ²	\$128.00

THHQC 120/240 Vac GO-135B

# of Poles	Ampere Rating	120/240 Vac Interrupting Rating	Wire Range ¹	Product Number ³	List Price
1	15	22kA	14-8 Cu/12-8 Al	THHQC1115WL ⁴	\$35.50
1	20	22kA	14-8 Cu/12-8 Al	THHQC1120WL ⁴	\$35.50
1	25	22kA	14-8 Cu/12-8 Al	THHQC1125WL ⁴	\$40.50
1	30	22kA	14-8 Cu/12-8 Al	THHQC1130WL ⁴	\$40.50
1	35	22kA	8-3 Cu/8-3 Al	THHQC1135WL ⁴	\$40.50
1	40	22kA	8-3 Cu/8-3 Al	THHQC1140WL ⁴	\$40.50
1	45	22kA	8-3 Cu/8-3 Al	THHQC1145WL ⁴	\$40.50
1	50	22kA	8-3 Cu/8-3 Al	THHQC1150WL ⁴	\$40.50
1	60	22kA	8-3 Cu/8-3 Al	THHQC1160WL ⁴	\$40.50
1	70	22kA	6-1/0 Cu/4-1/0 Al	THHQC1170WL	\$52.00

THHQC 120/240 Vac, Internal Common Trip GO-135B

# of Poles	Ampere Rating	120/240 Vac Interrupting Rating	Wire Range ¹	Product Number ³	List Price
2	15	22kA	14-8 Cu/12-8 Al	THHQC2115WL ⁴	\$83.50
2	20	22kA	14-8 Cu/12-8 Al	THHQC2120WL ⁴	\$83.50
2	30	22kA	14-8 Cu/12-8 Al	THHQC2130WL ⁴	\$83.50
2	35	22kA	8-3 Cu/8-3 Al	THHQC2135WL ⁴	\$83.50
2	40	22kA	8-3 Cu/8-3 Al	THHQC2140WL ⁴	\$83.50
2	45	22kA	8-3 Cu/8-3 Al	THHQC2145WL ⁴	\$83.50
2	50	22kA	8-3 Cu/8-3 Al	THHQC2150WL ⁴	\$83.50
2	60	22kA	8-3 Cu/8-3 Al	THHQC2160WL ⁴	\$83.50
2	70	22kA	6-1/0 Cu/4-1/0 Al	THHQC2170WL	\$129.00
2	80	22kA	6-1/0 Cu/4-1/0 Al	THHQC2180WL	\$188.00
2	90	22kA	6-1/0 Cu/4-1/0 Al	THHQC2190WL	\$188.00
2	100	22kA	6-1/0 Cu/4-1/0 Al	THHQC21100WL	\$188.00

¹Solid or stranded for 14-10 AWG.

²Requires mounting plate. See page 3-34. Not suitable for use in GE column panels.

³Use additional suffix "BP" (THQC32020WLBP) for bulk pack of 48 poles. Carton weight 20 lbs. 15 - 60 amperes breakers only.

⁴Suitable for mounting on standard 35mm DIN Rail.

UL listed HACR (heating, air conditioning and refrigeration).

Use Q Line mounting accessories listed on pages 3-34 to 3-36.

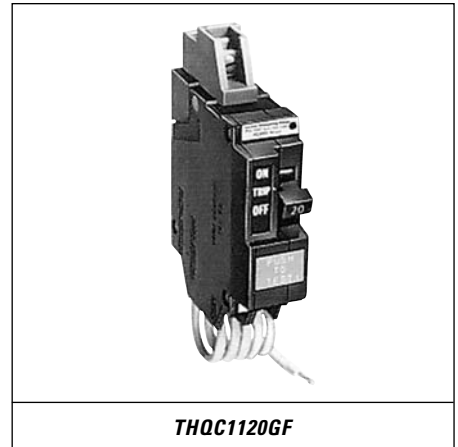

THQC1120GF



Miniature Circuit Breakers and Supplementary Protectors

Cable-in Cable-out (lug-lug)

240V Class

THHQC 240 Vac, Internal Common Trip **GO-135B**

# of Poles	Ampere Rating	240 Vac Interrupting Rating	Wire Range ¹	Product Number	List Price
2	15	22kA	14-8 Cu/12-8 Al	THHQC22015WL	\$159.00
2	20	22kA	14-8 Cu/12-8 Al	THHQC22020WL	\$159.00
2	25	22kA	14-8 Cu/12-8 Al	THHQC22025WL	\$159.00
2	30	22kA	14-8 Cu/12-8 Al	THHQC22030WL	\$159.00
2	35	22kA	8-3 Cu/8-3 Al	THHQC22035WL	\$159.00
2	40	22kA	8-3 Cu/8-3 Al	THHQC22040WL	\$159.00
2	45	22kA	8-3 Cu/8-3 Al	THHQC22045WL	\$159.00
2	50	22kA	8-3 Cu/8-3 Al	THHQC22050WL	\$159.00
2	60	22kA	8-3 Cu/8-3 Al	THHQC22060WL	\$159.00
2	70	22kA	6-1/0 Cu/4-1/0 Al	THHQC22070WL	\$200.00
2	80	22kA	6-1/0 Cu/4-1/0 Al	THHQC22080WL	\$240.00
2	90	22kA	6-1/0 Cu/4-1/0 Al	THHQC22090WL	\$240.00
2	100	22kA	6-1/0 Cu/4-1/0 Al	THHQC22100WL	\$240.00
3	15	22kA	14-8 Cu/12-8 Al	THHQC32015WL	\$216.00
3	20	22kA	14-8 Cu/12-8 Al	THHQC32020WL	\$216.00
3	25	22kA	14-8 Cu/12-8 Al	THHQC32025WL	\$216.00
3	30	22kA	14-8 Cu/12-8 Al	THHQC32030WL	\$216.00
3	35	22kA	8-3 Cu/8-3 Al	THHQC32035WL	\$216.00
3	40	22kA	8-3 Cu/8-3 Al	THHQC32040WL	\$216.00
3	45	22kA	8-3 Cu/8-3 Al	THHQC32045WL	\$216.00
3	50	22kA	8-3 Cu/8-3 Al	THHQC32050WL	\$216.00
3	60	22kA	8-3 Cu/8-3 Al	THHQC32060WL	\$216.00
3	70	22kA	6-1/0 Cu/4-1/0 Al	THHQC32070WL	\$267.00
3	80	22kA	6-1/0 Cu/4-1/0 Al	THHQC32080WL	\$314.00
3	90	22kA	6-1/0 Cu/4-1/0 Al	THHQC32090WL	\$314.00
3	100	22kA	6-1/0 Cu/4-1/0 Al	THHQC32100WL	\$314.00

TXQC 120/240 Vac **GO-135B**

# of Poles	Ampere Rating	120/240 Vac Interrupting Rating	Wire Range ¹	Product Number	List Price
1	15	65kA	14-8 Cu/12-8 Al	TXQC1115WL	\$63.50
1	20	65kA	14-8 Cu/12-8 Al	TXQC1120WL	\$63.50
1	25	65kA	14-8 Cu/12-8 Al	TXQC1125WL	\$63.50
1	30	65kA	14-8 Cu/12-8 Al	TXQC1130WL	\$63.50

TXQC 120/240 Vac, Internal Common Trip **GO-135B**

# of Poles	Ampere Rating	120/240 Vac Interrupting Rating	Wire Range ¹	Product Number	List Price
2	15	65kA	14-8 Cu/12-8 Al	TXQC2115WL	\$157.00
2	20	65kA	14-8 Cu/12-8 Al	TXQC2120WL	\$157.00
2	25	65kA	14-8 Cu/12-8 Al	TXQC2125WL	\$157.00
2	30	65kA	14-8 Cu/12-8 Al	TXQC2130WL	\$157.00

TXQC 240 Vac, Internal Common Trip **GO-138A**

# of Poles	Ampere Rating	120/240 Vac Interrupting Rating	Wire Range ¹	Product Number	List Price
3	15	65kA	14-8 Cu/12-8 Al	TXQC32015WL	\$267.00
3	20	65kA	14-8 Cu/12-8 Al	TXQC32020WL	\$267.00
3	25	65kA	14-8 Cu/12-8 Al	TXQC32025WL	\$267.00
3	30	65kA	14-8 Cu/12-8 Al	TXQC32030WL	\$267.00

¹Solid or stranded for 14-10 AWG.

UL listed HACR (heating, air conditioning and refrigeration).

Use Q Line mounting accessories listed on pages 3-34 to 3-36.

www.DataSheet4U.com



MOLDED CASE CIRCUIT BREAKERS

3

Miniature Circuit Breakers and Supplementary Protectors

DIN-Rail Mount
240V Class

Product Features

Multi-terminal Configuration Breakers

- 35 mm DIN rail mounting
- Optional front/rear panel mounting kits—THQCFMK, page 3-34.
- Optional load end terminal for up to (4) 0.25-inch quick connects.

Contact local GE sales office for ring terminal configurations—not DIN rail compatible.

THQC, THHQC 120/240 Vac					GO-135B	
# of Poles	Ampere Rating	120/240 Vac Interrupting Rating	Product Number	List Price	CC Suffix List Price Adder	X2 Suffix List Price Adder
1	15	10kA	THQC1115LL ¹	\$17.25		
1	20	10kA	THQC1120LL ¹	\$17.25		
1	25	10kA	THQC1125LL	\$17.25		
1	30	10kA	THQC1130LL	\$17.25		
1	35	10kA	THQC1135LL	\$17.25		
1	40	10kA	THQC1140LL	\$17.25		
1	45	10kA	THQC1145LL	\$17.25		
1	50	10kA	THQC1150LL	\$17.25		
1	60	10kA	THQC1160LL	\$17.25	\$4.00	\$1.50
1	15	22kA	THHQC1115LL	\$32.50		
1	20	22kA	THHQC1120LL	\$32.50		
1	25	22kA	THHQC1125LL	\$37.50		
1	30	22kA	THHQC1130LL	\$37.50		
1	35	22kA	THHQC1135LL	\$37.50		
1	40	22kA	THHQC1140LL	\$37.50		
1	45	22kA	THHQC1145LL	\$37.50		
1	50	22kA	THHQC1150LL	\$37.50		
1	60	22kA	THHQC1160LL	\$37.50		

15-60A UL Listed HACR (heating, air conditioning and refrigeration)

THQC, THHQC 120/240 Vac, Internal Common Trip					GO-135B	
# of Poles	Ampere Rating	120/240 Vac Interrupting Rating	Product Number	List Price	CC Suffix List Price Adder	X2 Suffix List Price Adder
2	15	10kA	THQC2115LL ¹	\$37.50		
2	20	10kA	THQC2120LL ¹	\$37.50		
2	25	10kA	THQC2125LL	\$37.50		
2	30	10kA	THQC2130LL	\$37.50		
2	35	10kA	THQC2135LL	\$37.50		
2	40	10kA	THQC2140LL	\$37.50		
2	45	10kA	THQC2145LL	\$37.50		
2	50	10kA	THQC2150LL	\$37.50		
2	60	10kA	THQC2160LL	\$37.50	\$8.00	\$3.00
2	15	22kA	THHQC2115LL	\$77.50		
2	20	22kA	THHQC2120LL	\$77.50		
2	25	22kA	THHQC2125LL	\$77.50		
2	30	22kA	THHQC2130LL	\$77.50		
2	35	22kA	THHQC2135LL	\$77.50		
2	40	22kA	THHQC2140LL	\$77.50		
2	45	22kA	THHQC2145LL	\$77.50		
2	50	22kA	THHQC2150LL	\$77.50		
2	60	22kA	THHQC2160LL	\$77.50		

15-60A UL Listed HACR (heating, air conditioning and refrigeration)

Terminal Configuration		
Suffix ²	Line Terminal	Load Terminal
WL	TOAL3A	THQEL3
X2	TOAL3A	N/A
LL	N/A	N/A
CC	TOAL3A	THQECC
None	N/A	THQEL3

Terminal Selection				GO-135B
Type	Wire Range	Product Number	List Price	
Lug-Line only	14-6 Cu/12-2 Al	TOAL3A	\$1.50	
Lug-Load only	14-2 Cu/12-2 Al	THQEL3	\$1.50	
Quick Connector-Load only	(4) 14 Cu or (4) 12 Al	THQECC	\$2.50	

¹15 and 20 ampere breakers UL listed as SWD (Switching Duty) rated. Suitable for switching 120 Vac fluorescent lighting loads.

²Use additional suffix "BP" (THQC1120CCBP) for bulk pack of 48 poles. Must be ordered in multiples of 48 poles.

Additional Q Line mounting accessories listed on pages 3-34 to 3-36.

Publications and Reference: See Section 31 for a list of additional product-related publications



MOLDED CASE CIRCUIT BREAKERS 3

Miniature Circuit Breakers and Supplementary Protectors

Cable-in Cable-out (lug-lug)

240V Class

TQD 240 Vac, Internal Common Trip GO-135F

# of Poles	Ampere Rating	240 Vac Interrupting Rating	Product Number ^{1,2}	List Price
2	100	10kA	TQD22100WL	\$249.00
2	125	10kA	TQD22125WL	\$249.00
2	150	10kA	TQD22150WL	\$249.00
2	175	10kA	TQD22175WL	\$249.00
2	200	10kA	TQD22200WL	\$249.00
2	225	10kA	TQD22225WL	\$249.00
3	100	10kA	TQD32100WL	\$641.00
3	125	10kA	TQD32125WL	\$641.00
3	150	10kA	TQD32150WL	\$641.00
3	175	10kA	TQD32175WL	\$641.00
3	200	10kA	TQD32200WL	\$641.00
3	225	10kA	TQD32225WL	\$641.00

TQD 240 Vac, Internal Common Trip with Factory Installed 120 Vac Shunt Trip³ GO-135F

# of Poles	Ampere Rating	240 Vac Interrupting Rating	Product Number ^{1,2}	List Price
3	125	10kA	TQD32125ST1	\$793.00
3	150	10kA	TQD32150ST1	\$793.00
3	175	10kA	TQD32175ST1	\$793.00
3	200	10kA	TQD32200ST1	\$793.00
3	225	10kA	TQD32225ST1	\$793.00

THQD 240 Vac, Internal Common Trip GO-135F

# of Poles	Ampere Rating	240 Vac Interrupting Rating	Product Number ^{1,2}	List Price
2	100	22kA	THQD22100WL	\$568.00
2	125	22kA	THQD22125WL	\$568.00
2	150	22kA	THQD22150WL	\$568.00
2	175	22kA	THQD22175WL	\$568.00
2	200	22kA	THQD22200WL	\$568.00
2	225	22kA	THQD22225WL	\$568.00
3	100	22kA	THQD32100WL	\$907.00
3	125	22kA	THQD32125WL	\$907.00
3	150	22kA	THQD32150WL	\$907.00
3	175	22kA	THQD32175WL	\$907.00
3	200	22kA	THQD32200WL	\$907.00
3	225	22kA	THQD32225WL	\$907.00

TJD 240 Vac, Internal Common Trip GO-135F

# of Poles	Ampere Rating	240 Vac Interrupting Rating	Product Number ^{1,2}	List Price
2	250	22kA	TJD422250WL	\$1494.00
2	300	22kA	TJD422300WL	\$1494.00
2	350	22kA	TJD422350WL	\$1494.00
2	400	22kA	TJD422400WL	\$1494.00
3	250	22kA	TJD432250WL ⁴	\$1802.00
3	300	22kA	TJD432300WL ⁴	\$1802.00
3	350	22kA	TJD432350WL ⁴	\$1802.00
3	400	22kA	TJD432400WL ⁴	\$1802.00

¹Refer to table on page 3-101 for lug and wire range data.

²Includes line and load lugs. For optional configurations see page 3-38.

³For additional shunt trip options see page 3-88.

⁴TJD uses same accessories as J600 line. TJD not listed HACR. UL listed HACR (heating, air conditioning and refrigeration).

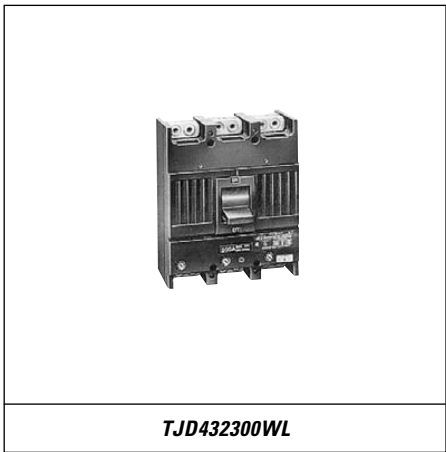

MOLDED CASE CIRCUIT BREAKERS

3



Miniature Circuit Breakers and Supplementary Protectors

Molded Case Switches

Note: Molded case switches may be used as main devices in panelboards and switchboards but cannot be used as subfeeds or branch breakers because they do not provide wire protection. Q Line and TEB molded case switches have a 10,000 ampere symmetrical short circuit withstand rating when protected by a fuse or circuit breaker rated 10,000 amperes IC or greater and whose ampere rating does not exceed the ampere rating of the switch.

Plug-in TQL 120/240, Vac Internal Common Trip GO-138

# of Poles	Ampere Rating	120/240 Vac Short Circuit Withstand Rating	Wire Range ¹	Product Number	List Price
2	60	10kA	8-3 Cu/8-3 Al	TQL21Y60	\$51.00
2	100	10kA	6-1/0 Cu/4-1/0 Al	TQL21Y100	\$147.00

Plug-in TQL 240, Vac Internal Common Trip GO-138

# of Poles	Ampere Rating	240 Vac Short Circuit Withstand Rating	Wire Range ¹	Product Number	List Price
2	60	10kA	8-3 Cu/8-3 Al	TQL22Y60	\$139.00
2	100	10kA	6-1/0 Cu/4-1/0 Al	TQL22Y100	\$235.00
3	60	10kA	8-3 Cu/8-3 Al	TQL32Y60	\$177.00
3	100	10kA	6-1/0 Cu/4-1/0 Al	TQL32Y100	\$266.00

Bolt-on TQB 120/240, Vac Internal Common Trip GO-138

# of Poles	Ampere Rating	120/240 Vac Short Circuit Withstand Rating	Wire Range ¹	Product Number	List Price
2	60	10kA	8-3 Cu/8-3 Al	TQB21Y60	\$43.50
2	100	10kA	6-1/0 Cu/4-1/0 Al	TQB21Y100	\$113.00

Bolt-on TQB 240 Vac, Internal Common Trip GO-138

# of Poles	Ampere Rating	240 Vac Short Circuit Withstand Rating	Wire Range ¹	Product Number	List Price
2	60	10kA	8-3 Cu/8-3 Al	TQB22Y60	\$113.00
2	100	10kA	6-1/0 Cu/4-1/0 Al	TQB22Y100	\$170.00
3	60	10kA	8-3 Cu/8-3 Al	TQB32Y60	\$139.00
3	100	10kA	6-1/0 Cu/4-1/0 Al	TQB32Y100	\$199.00

Cable In-Cable Out (Lug-Lug) TQC 120/240 Vac, Internal Common Trip GO-135B

# of Poles	Ampere Rating	120/240 Vac Short Circuit Withstand Rating	Wire Range ¹	Product Number	List Price
2	60	10kA	8-3 Cu/8-3 Al	TQC21Y60 ²	\$43.50
2	100	10kA	6-1/0 Cu/4-1/0 Al	TQC21Y100	\$116.00

Cable In-Cable Out (Lug-Lug) TQC 240 Vac, Internal Common Trip GO-135B

# of Poles	Ampere Rating	240 Vac Short Circuit Withstand Rating	Wire Range ¹	Product Number	List Price
2	60	10kA	8-3 Cu/8-3 Al	TQC22Y60 ³	\$116.00
2	100	10kA	6-1/0 Cu/4-1/0 Al	TQC22Y100	\$173.00
3	60	10kA	8-3 Cu/8-3 Al	TQB32Y60	\$139.00
3	100	10kA	6-1/0 Cu/4-1/0 Al	TQB32Y100	\$199.00

Cable In-Cable Out (Lug-Lug) TQD, TJD 240 Vac, Internal Common Trip GO-135F

# of Poles	Ampere Rating	240 Vac Short Circuit Withstand Rating	Product Number ⁶	List Price
2	225	14kA	TQD22Y225	\$198.00
3	225	14kA	TQD32Y225 ⁴	\$559.00
2	400	22kA	TJD422Y400	\$1169.00
3	400	22kA	TJD432Y400 ⁵	\$1509.00

¹Solid or stranded for 14-10 AWG.

²Suitable for mounting on 35 mm DIN rail.

³For additional shunt trip offerings, see page 3-88.

⁴TQD32YT225 with dummy trip used for accessorized applications.

⁵TJD uses same accessories as J600 line.

⁶Refer to table on page 3-101 for lug and wire range data. Line and load lugs included in basic switch product number.

Publications and Reference: See Section 21 for a list of additional product-related publications



E2000 Miniature Circuit Breakers

EP60 Series

Applications

- Residential
- Commercial
- Industrial

Performance

Thermal setting I_n (A)	0.5-63
Rated Vac U_n (V)	240/415
Minimum operating voltage U_B min (V)	12
Tripping characteristics	B-C-D
Selectivity class	3
Mechanical/electrical endurance	20000/10000
Tropicalisation acc. to IEC 60068-2	95% RH at 55°C
Terminal capacity flexible/rigid cable mm ²	25-35
Poles	1, 2, 3, 4
Weight (g/pole)	120

Short-circuit Capacity

Per UL 1077 & CSA 22.2 No. 235-1989 (File E151139)

Poles	Max. Voltage Rating		Short Circuit Rating				kAIC DC	
	AC	DC	120	120/240	277	480Y/277	50	110
1	277	50	10	—	6	6	10	—
2	480Y/277	110	10	10	6	6	—	10
3, 4	480Y/277	110	10	10	6	6	—	—

AC acc. to IEC 60898

Poles	V	I_{cn}/I_{cs} (kA)
1-4	230/400	6

AC acc. to IEC 60947-2

Poles	V	I_{cu} (kA) ¹
1	240	10
2,3,4	240	20
2,3,4	415	10

¹ $I_{cs} = 75\% I_{cu}$

DC acc. to IEC 60947-2

Poles	V	I_{cu}/I_{cs} (kA)
1	60	20
2	125	25

Approval/Marking

- CE
- cURus
- CEBEC
- KEMA EUR

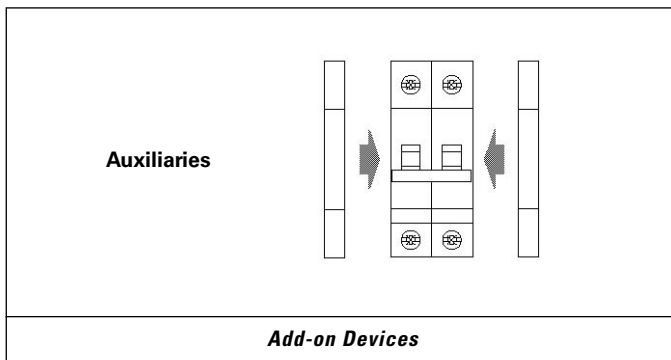

MOLDED CASE CIRCUIT BREAKERS

3

www.DataSheet4U.com



E2000 Miniature Circuit Breakers

EP60 Series

EP60 Series, 6 kAIC @277 or 480Y/277 Vac, Tripping Characteristics B-C-D GO-135VB

Poles	Std. Pack	6 kAIC In (A)	Tripping Characteristic			List Price
			B (3-5X) Product No.	C (5-10X) Product No.	D (10-20X) Product No.	
1	12	0.5	-	EP61ULC0.5	EP61ULD0.5	\$78.00
		1	-	EP61ULC01	EP61ULD01	\$65.00
		2	-	EP61ULC02	EP61ULD02	\$65.00
		3	-	EP61ULC03	EP61ULD03	\$65.00
		4	-	EP61ULC04	EP61ULD04	\$65.00
		5	EP61ULB05	EP61ULC05	EP61ULD05	\$65.00
		6	EP61ULB06	EP61ULC06	EP61ULD06	\$65.00
		10	EP61ULB10	EP61ULC10	EP61ULD10	\$65.00
		13	EP61ULB13	EP61ULC13	EP61ULD13	\$65.00
		15	EP61ULB15	EP61ULC15	EP61ULD15	\$65.00
		16	EP61ULB16	EP61ULC16	EP61ULD16	\$65.00
		20	EP61ULB20	EP61ULC20	EP61ULD20	\$65.00
		25	EP61ULB25	EP61ULC25	EP61ULD25	\$65.00
		30	EP61ULB30	EP61ULC30	EP61ULD30	\$65.00
		32	EP61ULB32	EP61ULC32	EP61ULD32	\$65.00
		40	EP61ULB40	EP61ULC40	EP61ULD40	\$72.00
		50	EP61ULB50	EP61ULC50	EP61ULD50	\$76.00
		60	EP61ULB60	EP61ULC60	EP61ULD60	\$80.00
63	EP61ULB63	EP61ULC63	EP61ULD63	\$80.00		
2	6	0.5	-	EP62ULC0.5	EP62ULD0.5	\$156.00
		1	-	EP62ULC01	EP62ULD01	\$141.00
		2	-	EP62ULC02	EP62ULD02	\$141.00
		3	-	EP62ULC03	EP62ULD03	\$141.00
		4	-	EP62ULC04	EP62ULD04	\$141.00
		5	EP62ULB05	EP62ULC05	EP62ULD05	\$141.00
		6	EP62ULB06	EP62ULC06	EP62ULD06	\$141.00
		10	EP62ULB10	EP62ULC10	EP62ULD10	\$141.00
		13	EP62ULB13	EP62ULC13	EP62ULD13	\$141.00
		15	EP62ULB15	EP62ULC15	EP62ULD15	\$141.00
		16	EP62ULB16	EP62ULC16	EP62ULD16	\$141.00
		20	EP62ULB20	EP62ULC20	EP62ULD20	\$141.00
		25	EP62ULB25	EP62ULC25	EP62ULD25	\$141.00
		30	EP62ULB30	EP62ULC30	EP62ULD30	\$141.00
		32	EP62ULB32	EP62ULC32	EP62ULD32	\$141.00
		40	EP62ULB40	EP62ULC40	EP62ULD40	\$145.00
		50	EP62ULB50	EP62ULC50	EP62ULD50	\$156.00
		60	EP62ULB60	EP62ULC60	EP62ULD60	\$164.00
63	EP62ULB63	EP62ULC63	EP62ULD63	\$164.00		
3	4	0.5	-	EP63ULC0.5	EP63ULD0.5	\$230.00
		1	-	EP63ULC01	EP63ULD01	\$204.00
		2	-	EP63ULC02	EP63ULD02	\$204.00
		3	-	EP63ULC03	EP63ULD03	\$204.00
		4	-	EP63ULC04	EP63ULD04	\$204.00
		5	EP63ULB05	EP63ULC05	EP63ULD05	\$204.00
		6	EP63ULB06	EP63ULC06	EP63ULD06	\$204.00
		10	EP63ULB10	EP63ULC10	EP63ULD10	\$204.00
		13	EP63ULB13	EP63ULC13	EP63ULD13	\$204.00
		15	EP63ULB15	EP63ULC15	EP63ULD15	\$204.00
		16	EP63ULB16	EP63ULC16	EP63ULD16	\$204.00
		20	EP63ULB20	EP63ULC20	EP63ULD20	\$204.00
		25	EP63ULB25	EP63ULC25	EP63ULD25	\$204.00
		30	EP63ULB30	EP63ULC30	EP63ULD30	\$204.00
		32	EP63ULB32	EP63ULC32	EP63ULD32	\$204.00
		40	EP63ULB40	EP63ULC40	EP63ULD40	\$210.00
		50	EP63ULB50	EP63ULC50	EP63ULD50	\$219.00
		60	EP63ULB60	EP63ULC60	EP63ULD60	\$229.00
63	EP63ULB63	EP63ULC63	EP63ULD63	\$229.00		
4	3	0.5	-	EP64ULC0.5	EP64ULD0.5	\$300.00
		1	-	EP64ULC01	EP64ULD01	\$269.00
		2	-	EP64ULC02	EP64ULD02	\$269.00
		3	-	EP64ULC03	EP64ULD03	\$269.00
		4	-	EP64ULC04	EP64ULD04	\$269.00
		5	EP64ULB05	EP64ULC05	EP64ULD05	\$269.00
		6	EP64ULB06	EP64ULC06	EP64ULD06	\$269.00
		10	EP64ULB10	EP64ULC10	EP64ULD10	\$269.00
		13	EP64ULB13	EP64ULC13	EP64ULD13	\$269.00
		15	EP64ULB15	EP64ULC15	EP64ULD15	\$269.00
		16	EP64ULB16	EP64ULC16	EP64ULD16	\$269.00
		20	EP64ULB20	EP64ULC20	EP64ULD20	\$269.00
		25	EP64ULB25	EP64ULC25	EP64ULD25	\$269.00
		30	EP64ULB30	EP64ULC30	EP64ULD30	\$269.00
		32	EP64ULB32	EP64ULC32	EP64ULD32	\$269.00
		40	EP64ULB40	EP64ULC40	EP64ULD40	\$272.00
		50	EP64ULB50	EP64ULC50	EP64ULD50	\$285.00
		60	EP64ULB60	EP64ULC60	EP64ULD60	\$293.00
63	EP64ULB63	EP64ULC63	EP64ULD63	\$293.00		

www.DataSheet4U.com

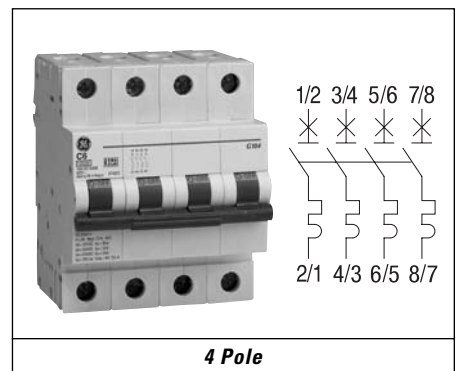
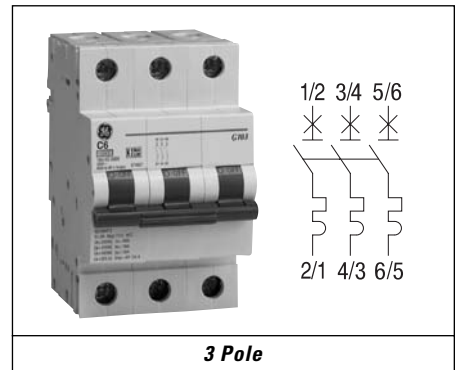
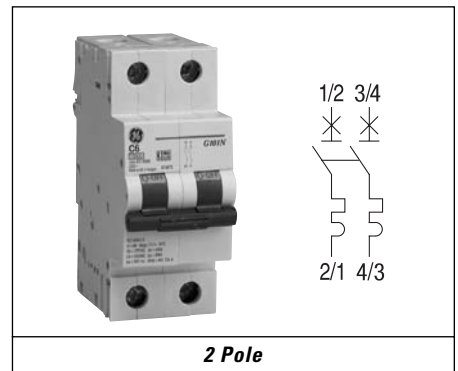
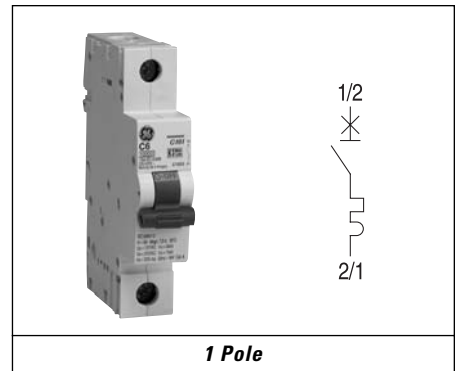

MOLDED CASE
CIRCUIT BREAKERS
3

Publications and Reference: See Section 31 for a list of additional product-related publications

E2000 Miniature Circuit Breakers

EP100 Series

Applications

- Residential
- Commercial
- Industrial

Performance

Thermal setting I_n (A)	0.5-63
Rated Vac U_n (V)	240/415
Minimum operating voltage U_B min (V)	12
Tripping characteristics	B-C-D
Selectivity class	3
Mechanical/electrical endurance	20000/10000
Tropicalisation acc. to IEC 60068-2	95% RH at 55°C
Terminal capacity flexible/rigid cable mm ²	25-35
Poles	1, 2, 3, 4
Weight (g/pole)	120

Short-circuit Capacity

Per UL 1077 & CSA 22.2 No. 235-1989 (File E151139)

Poles	Max. Voltage Rating		Short Circuit Rating kAIC RMS Symmetrical				kAIC DC	
	AC	DC	120	120/240	277	480Y/277	50	110
1	277	50	10	—	10	—	10	—
2	480Y/277	110	10	10	10	—	—	10
3, 4	480Y/277	110	10	10	10	10	—	—

AC acc. to IEC 60898

Poles	V	I_{cn} (kA) ¹
1-4	230/400	10

¹ $I_{cs} = 75\% I_{cu}$

AC acc. to IEC 60947-2

Poles	V	I_{cu} (kA) ²
1	240	15
2,3,4	240	30
2,3,4	415	15

² $I_{cs} = 50\% I_{cu}$

DC acc. to IEC 60947-2

Poles	V	I_{cu}/I_{cs} (kA)
1	60	25
2	125	30

Approval/Marking

- CE
- cURus
- CEBEC
- KEMA EUR

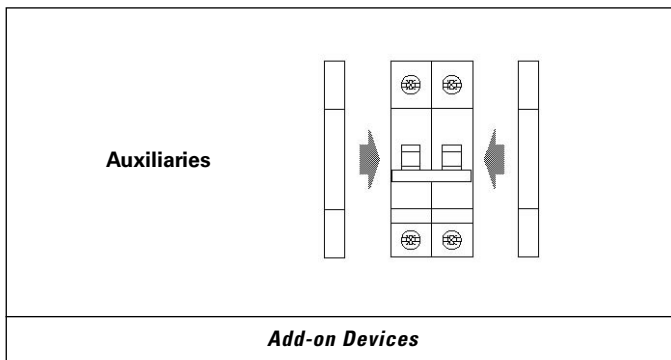

MOLDED CASE
CIRCUIT BREAKERS

3

www.DataSheet4U.com



E2000 Miniature Circuit Breakers

EP100 Series

EP100 Series, 10 kAIC @120 or 120/240 Vac, Tripping Characteristics B-C-D GO-135VB

Poles	Std. Pack	6 kAIC In (A)	Tripping Characteristic			List Price
			B (3-5X) Product No.	C (5-10X) Product No.	D (10-20X) Product No.	
1	12	0.5	-	EP101ULC0.5	EP101ULD0.5	\$116.00
		1	-	EP101ULC01	EP101ULD01	\$97.00
		2	-	EP101ULC02	EP101ULD02	\$97.00
		3	-	EP101ULC03	EP101ULD03	\$97.00
		4	-	EP101ULC04	EP101ULD04	\$97.00
		5	EP101ULB05	EP101ULC05	EP101ULD05	\$97.00
		6	EP101ULB06	EP101ULC06	EP101ULD06	\$97.00
		10	EP101ULB10	EP101ULC10	EP101ULD10	\$97.00
		13	EP101ULB13	EP101ULC13	EP101ULD13	\$97.00
		15	EP101ULB15	EP101ULC15	EP101ULD15	\$97.00
		16	EP101ULB16	EP101ULC16	EP101ULD16	\$97.00
		20	EP101ULB20	EP101ULC20	EP101ULD20	\$97.00
		25	EP101ULB25	EP101ULC25	EP101ULD25	\$97.00
		30	EP101ULB30	EP101ULC30	EP101ULD30	\$97.00
		32	EP101ULB32	EP101ULC32	EP101ULD32	\$97.00
		40	EP101ULB40	EP101ULC40	EP101ULD40	\$107.00
50	EP101ULB50	EP101ULC50	EP101ULD50	\$113.00		
60	EP101ULB60	EP101ULC60	EP101ULD60	\$119.00		
63	EP101ULB63	EP101ULC63	EP101ULD63	\$119.00		
2	6	0.5	-	EP102ULC0.5	EP102ULD0.5	\$233.00
		1	-	EP102ULC01	EP102ULD01	\$210.00
		2	-	EP102ULC02	EP102ULD02	\$210.00
		3	-	EP102ULC03	EP102ULD03	\$210.00
		4	-	EP102ULC04	EP102ULD04	\$210.00
		5	EP102ULB05	EP102ULC05	EP102ULD05	\$210.00
		6	EP102ULB06	EP102ULC06	EP102ULD06	\$210.00
		10	EP102ULB10	EP102ULC10	EP102ULD10	\$210.00
		13	EP102ULB13	EP102ULC13	EP102ULD13	\$210.00
		15	EP102ULB15	EP102ULC15	EP102ULD15	\$210.00
		16	EP102ULB16	EP102ULC16	EP102ULD16	\$210.00
		20	EP102ULB20	EP102ULC20	EP102ULD20	\$210.00
		25	EP102ULB25	EP102ULC25	EP102ULD25	\$210.00
		30	EP102ULB30	EP102ULC30	EP102ULD30	\$210.00
		32	EP102ULB32	EP102ULC32	EP102ULD32	\$210.00
		40	EP102ULB40	EP102ULC40	EP102ULD40	\$216.00
50	EP102ULB50	EP102ULC50	EP102ULD50	\$233.00		
60	EP102ULB60	EP102ULC60	EP102ULD60	\$245.00		
63	EP102ULB63	EP102ULC63	EP102ULD63	\$245.00		
3	4	0.5	-	EP103ULC0.5	EP103ULD0.5	\$343.00
		1	-	EP103ULC01	EP103ULD01	\$304.00
		2	-	EP103ULC02	EP103ULD02	\$304.00
		3	-	EP103ULC03	EP103ULD03	\$304.00
		4	-	EP103ULC04	EP103ULD04	\$304.00
		5	EP103ULB05	EP103ULC05	EP103ULD05	\$304.00
		6	EP103ULB06	EP103ULC06	EP103ULD06	\$304.00
		10	EP103ULB10	EP103ULC10	EP103ULD10	\$304.00
		13	EP103ULB13	EP103ULC13	EP103ULD13	\$304.00
		15	EP103ULB15	EP103ULC15	EP103ULD15	\$304.00
		16	EP103ULB16	EP103ULC16	EP103ULD16	\$304.00
		20	EP103ULB20	EP103ULC20	EP103ULD20	\$304.00
		25	EP103ULB25	EP103ULC25	EP103ULD25	\$304.00
		30	EP103ULB30	EP103ULC30	EP103ULD30	\$304.00
		32	EP103ULB32	EP103ULC32	EP103ULD32	\$304.00
		40	EP103ULB40	EP103ULC40	EP103ULD40	\$314.00
50	EP103ULB50	EP103ULC50	EP103ULD50	\$327.00		
60	EP103ULB60	EP103ULC60	EP103ULD60	\$342.00		
63	EP103ULB63	EP103ULC63	EP103ULD63	\$342.00		
4	3	0.5	-	EP104ULC0.5	EP104ULD0.5	\$448.00
		1	-	EP104ULC01	EP104ULD01	\$401.00
		2	-	EP104ULC02	EP104ULD02	\$401.00
		3	-	EP104ULC03	EP104ULD03	\$401.00
		4	-	EP104ULC04	EP104ULD04	\$401.00
		5	EP104ULB05	EP104ULC05	EP104ULD05	\$401.00
		6	EP104ULB06	EP104ULC06	EP104ULD06	\$401.00
		10	EP104ULB10	EP104ULC10	EP104ULD10	\$401.00
		13	EP104ULB13	EP104ULC13	EP104ULD13	\$401.00
		15	EP104ULB15	EP104ULC15	EP104ULD15	\$401.00
		16	EP104ULB16	EP104ULC16	EP104ULD16	\$401.00
		20	EP104ULB20	EP104ULC20	EP104ULD20	\$401.00
		25	EP104ULB25	EP104ULC25	EP104ULD25	\$401.00
		30	EP104ULB30	EP104ULC30	EP104ULD30	\$401.00
		32	EP104ULB32	EP104ULC32	EP104ULD32	\$401.00
		40	EP104ULB40	EP104ULC40	EP104ULD40	\$407.00
50	EP104ULB50	EP104ULC50	EP104ULD50	\$425.00		
60	EP104ULB60	EP104ULC60	EP104ULD60	\$437.00		
63	EP104ULB63	EP104ULC63	EP104ULD63	\$437.00		

www.DataSheet4U.com

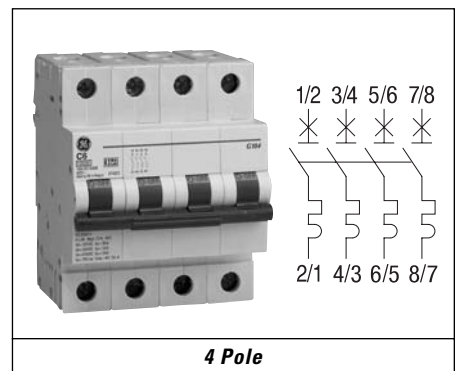
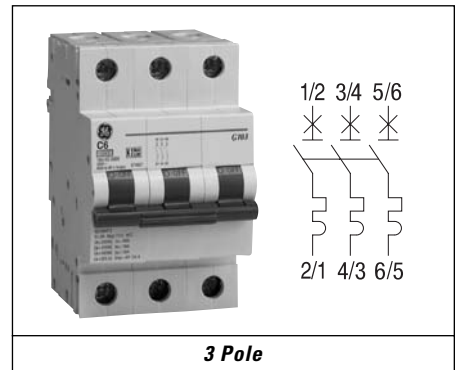
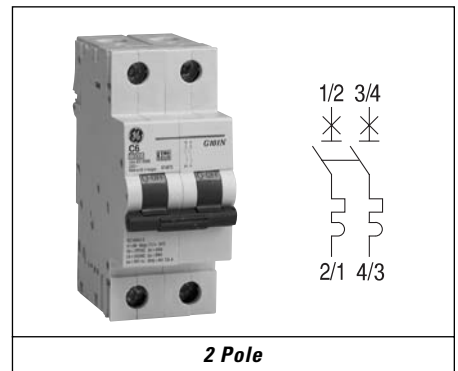
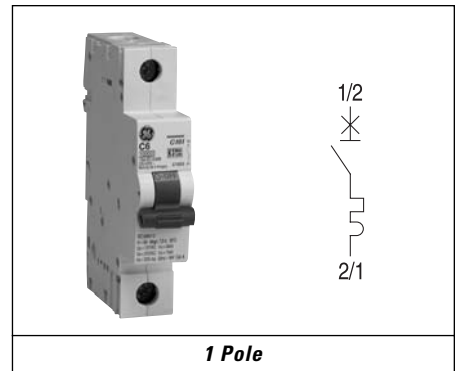

MOLDED CASE CIRCUIT BREAKERS 3

Publications and Reference: See Section 31 for a list of additional product-related publications

E2000 Miniature Circuit Breakers

EP100 UC Series¹

Applications

—Industrial

Performance

Thermal setting In (A)	0.5-63
Rated Vac Un (V)	240/400; 230/440
Minimum operating voltage U _B min (V)	12
Tripping characteristics	B-C
Selectivity class	3
Mechanical/electrical endurance	20000/10000
Tropicalisation acc. to IEC 60068-2	95% RH at 55°C
Terminal capacity flexible/rigid cable mm ²	25-35
Poles	1, 2
Weight (g/pole)	120

Short-circuit Capacity

AC acc. to IEC 60898

Poles	V	I _{cn} /I _{cs} (kA)
1	125 DC	10
	220 DC	6
	230/400 AC	6
	250 DC	10
2	440 DC	6
	400 AC	6

AC acc. to IEC 60947-2

Poles	V	I _{cu} /I _{cs} (kA)
1, 2	240 AC	10

Approval/Marking

—IEC 60898-2, DIN VDE 0641

—CE

¹Not UL approved

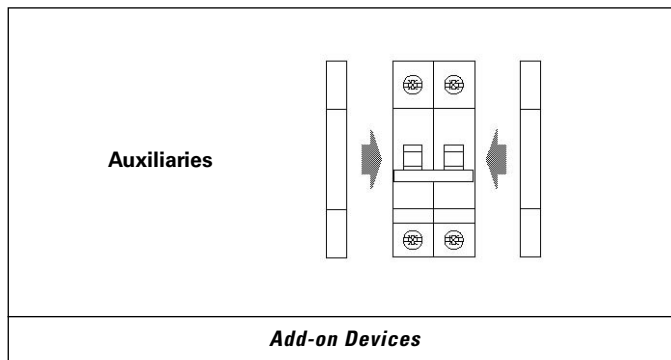

E2000 Miniature Circuit Breakers
EP100 UC Series¹

EP100 UC Series, 6 kAIC @400 or 230/400 Vac, Tripping Characteristics B-C GO-135VB

Poles	Std. Pack	6 kAIC In (A)	Tripping Characteristic		List Price
			B (3-5X) Product No.	C (5-10X) Product No.	
1	12	0.5	-	EP101UCC0.5	\$145.00
		1	-	EP101UCC01	\$121.00
		2	-	EP101UCC02	\$121.00
		4	-	EP101UCC04	\$121.00
		6	EP101UCB06	EP101UCC06	\$121.00
		10	EP101UCB10	EP101UCC10	\$121.00
		16	EP101UCB16	EP101UCC16	\$121.00
		20	EP101UCB20	EP101UCC20	\$121.00
		25	EP101UCB25	EP101UCC25	\$121.00
		32	EP101UCB32	EP101UCC32	\$121.00
		40	EP101UCB40	EP101UCC40	\$121.00
		50	EP101UCB50	EP101UCC50	\$145.00
		63	EP10s1UCB63	EP101UCC63	\$163.00
		2	6	0.5	-
1	-			EP102UCC01	\$267.00
2	-			EP102UCC02	\$267.00
4	-			EP102UCC04	\$267.00
6	EP102UCB06			EP102UCC06	\$267.00
10	EP102UCB10			EP102UCC10	\$267.00
16	EP102UCB16			EP102UCC16	\$267.00
20	EP102UCB20			EP102UCC20	\$267.00
25	EP102UCB25			EP102UCC25	\$267.00
32	EP102UCB32			EP102UCC32	\$267.00
40	EP102UCB40			EP102UCC40	\$267.00
50	EP102UCB50			EP102UCC50	\$319.00
63	EP102UCB63			EP102UCC63	\$360.00

¹Not UL approved

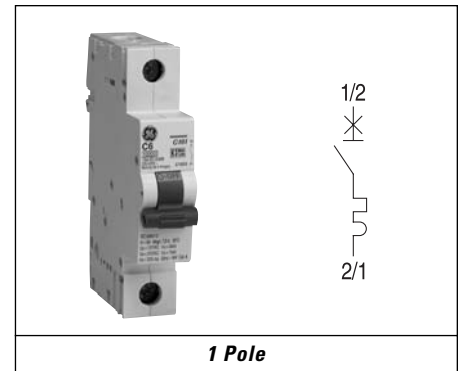

1 Pole

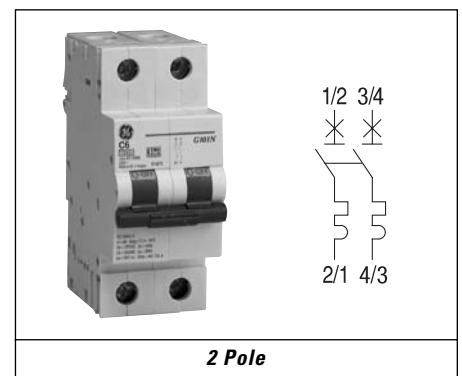

2 Pole

www.DataSheet4U.com

Publications and Reference: See Section 21 for a list of additional product-related publications



www.DataSheet4U.com

E2000 Miniature Circuit Breakers

Series CA Auxiliary Switch and Bell Alarm

Applications

- Commercial
- Industrial

Features

- Common for all MCBs
- Can be coupled on both sides of MCBs
- Gold contact version available for low current and low voltage applications
- Stack up to four CA on left and right sides
- Permits the pass-through of busbars, pin and fork, top and bottom, by changing the position of the base of the auxiliaries

Performance

Change-over contacts	1 Form C
Rate current In (A)	5
Rated voltage AC Un (V)	240
Electrical endurance	10000
Terminal capacity flexible/rigid cable (mm ²)	2.5
Weight (g)	70

Functions

Auxiliary contacts are units to be added on to protection devices. They allow information about the status of the protection device to be monitored from a distance.

Auxiliary contact CA H (function H) reports the OPEN/CLOSED status.

CA S/H or CA S/H G act as either an auxiliary contact (function H) or a signal contact (function S). The user can set the function at the time of installation. When used as a signal contact, it reports information about the automatic tripping of the protection devices. A test button on the front simulates functions H or S. There are also a reset button for the contacts (function S) and a tripping signal (function S).

Approval/Marking

- CE
- cURus
- CEBEC
- KEMA EUR

Series CA

GO-135VB

Function	Std. Pack	Product No.	List Price
H	1	CA H	\$47.00
S/H	1	CA S/H	\$59.00
S/H (gold contacts)	1	CA S/H G	\$59.00

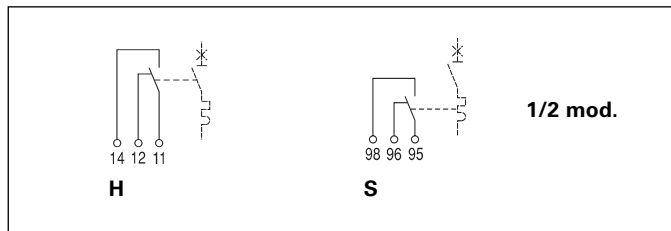
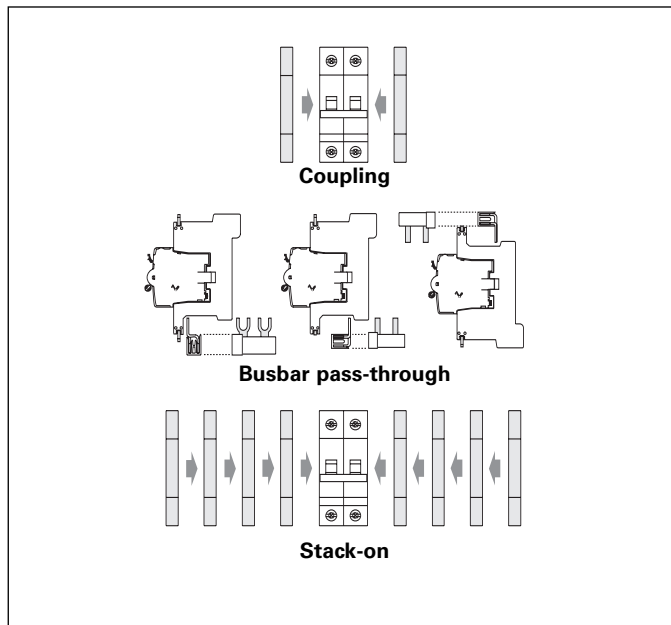

MOLDED CASE
CIRCUIT BREAKERS

3



E2000 Miniature Circuit Breakers

Series CB Auxiliary Switch and Bell Alarm

Applications

- Commercial
- Industrial

Features

- Common for all MCBs
- Can be coupled on both sides of MCBs
- There are two change-over contacts – the upper one features changeable function S/H
- CB SH/HH-R couples to the right side of the protection devices; CB SH/HH-L couple to the left
- No stack-on possibilities (only one auxiliary)
- No busbar pass-through facilities

Performance

Change-over contacts	2 Form C
Rate current In (A)	5
Rated voltage AC Un (V)	240
Electrical endurance	10000
Terminal capacity flexible/rigid cable (mm ²)	2.5
Weight (g)	80

Functions

The bottom auxiliary contact (function H) reports the OPEN/CLOSED status.

The top auxiliary contact can act as either an auxiliary contact (function H) or a signal contact (function S). The user can set the function at the time of installation. When used as a signal contact, it reports information about the automatic tripping of the protection devices.

A test button on the front simulates functions H or S. There are also a reset button for the contacts (function S) and a tripping signal (function S).

Approval/Marking

- cURus

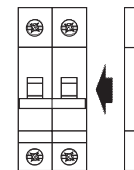
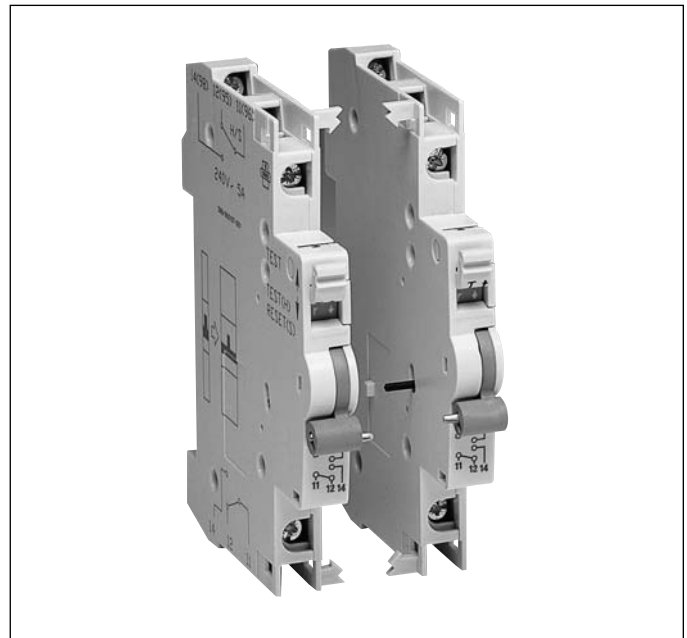

Coupling right

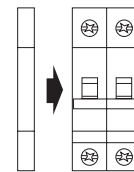

Coupling left

Series CB GO-135VB

Function	Coupling	Std. Pack	Product No.	List Price
SH/HH	Right	1	CB SH/HH-R	\$87.00
SH/HH	Left	1	CB SH/HH-L	\$87.00

www.DataSheet4U.com

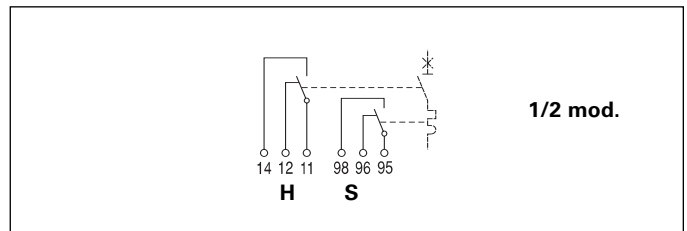

1/2 mod.

Publications and Reference: See Section 31 for a list of additional product-related publications

E2000 Miniature Circuit Breakers

Shunt Trip and Undervoltage Release

Applications

- Commercial
- Industrial

Features

- Common devices for all miniature circuit breakers
- Can be coupled on both sides of MCBs
- Permits pass-through of busbars, pin and fork, at top or bottom terminals
- Stack up to four modules on left and right sides

Approval/Marking

- CURUS
- IEC 947-2

Shunt Trip Tele L

The Tele L allows remote switching of any miniature circuit breaker by means of push buttons or any other automatic management processor. A built-in contact, in series with the coil, prevents burnout damage if the voltage remains.

Shunt Trip Tele L Performance

Rated voltage (V)	110/415, 110/125 DC
(V)	24/60, 24/48 DC
Tripping time (ms)	<10
Electrical endurance	10000
Terminal capacity flexible/rigid cable (mm ²)	2.5
Weight (g)	125

Shunt Trip Tele L

GO-135VB

Poles	Std. Pack	Voltage		Product No.	List Price
		AC	DC		
1	1	24-60 V	24-48 V	TELE L-1	\$90.00
		110-415 V	110-125 V	TELE L-2	\$90.00

Undervoltage Release Tele U

The Tele U releases the main miniature circuit breaker in case the power supply drops below 0.5xUn. Time delay is adjustable up to 300 ms.

Undervoltage Release Tele U Performance

Rated voltage AC UN (V)	240
Rated voltage DC/AC UN (V)	12, 24, 48 DC/AC
Tripping voltage (V)	≤0.5xUN ±10%
Resetting voltage (V)	>0.5xUN ±10%
Tripping time (ms)	Adjustable 1-300
Electrical endurance	2000
Terminal capacity flexible/rigid cable (mm ²)	2.5
Weight (g)	125

Undervoltage Release Tele U

GO-135VB

Poles	Std. Pack	Voltage		Product No.	List Price
		AC	DC		
1	1	AC 230V		TELE U-230	\$128.00
		AC/DC 12V		TELE U-12	\$128.00
		AC/DC 24V		TELE U-24	\$128.00
		AC/DC 48V		TELE U-48	\$128.00

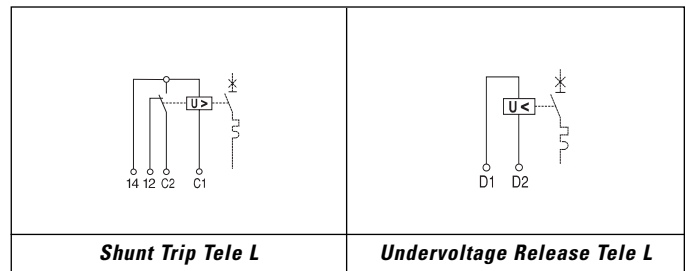
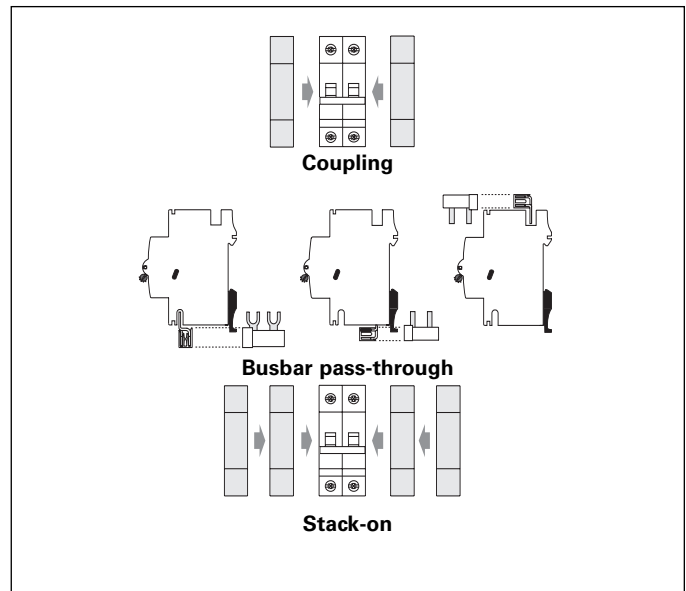

MOLDED CASE CIRCUIT BREAKERS

3



E2000 Miniature Circuit Breakers

Technical Data

				Series		
				EP60	EP100	EP100 UC
Standards				UL1077, EN60947-2	UL1077, EN60947-2	IEC EN70898-2
Tripping characteristics				B, C, D	B, C, D	B, C
Nominal current				A	B: 6-63, C/D: 0.5-63	B: 6-63, C: 0.5-63
Calibration temperature				°C	30	30
Number of poles (# mod)					1/1+N/2/3/4	1/2
Neutral pole protected					yes	–
Nominal voltage Un	AC	1P	V	240/415	240/415	240/415
		2P	V	415	415	415
		3P/3P+N/4P	V	415	415	415
	DC	1P (1)	Vdc	48	48	220
		2P (in series) (1)	Vdc	110	110	440
			Hz	50/60	50/60	50/60
Frequency				Hz	DC:magn.trip + 40%	DC:magn.trip + 40%
				Hz	DC:magn.trip + 50%	400:magn.trip + 50%
Maximum service voltage U _{max} between two wires				V	250/440; 53/120	250/440; 53/120
Minimum service voltage U _{min}				V	12; 12	12; 12
Selectivity class (IEC 60898)					3	3
Isolator application IEC 60947-2					yes	yes
Rated insulation voltage – Pollution Degree 2				V	500	500
Rated insulation voltage – Pollution Degree 3				V	440	440
Impulse withstand test voltage				Kv	6	6
Insulation resistance				Mohm	10000	10000
Dielectric rigidity				Kv	2.5	2.5
Vibrations resistance (in x,y,z direction) (IEC 77/16,3)					3g	3g
Endurance – electrical at U _n , I _n					10000	10000
Endurance – mechanical					20000	20000
Utilization category (IEC 60947 - 2)					A	A
Mounting position					any	any
Incoming top or bottom					yes	yes
Protection degree (outside/inside enclosure with door)					IP20/IP40	IP20/IP40
Self extinguish degree (according to UL94)					V2	V2
Tropicalisation (according to IEC 60068-2/DIN 40046)				°C/RH	+55°C/95% RH	+55°C/95% RH
Operating temperature				°C	-25/+55	-25/+55
Storage temperature				°C	-55/+55	-55/+55
Terminal capacity – Rigid cable min/max (top)				mm ²	1/35	1/35
Terminal capacity – Flexible cable min*/max (top) (*Flexible cable 0.75/1/1.5 mm ² with cable lug)				mm ²	0.75/25	0.75/25
Terminal capacity – Rigid cable min/max (bottom)				mm ²	1/35	1/35
Terminal Capacity – Flexible cable min*/max (bottom) (*Flexible cable 0.75/1/1.5 mm ² with cable lug)				mm ²	0.75/25	0.75/25
Torque				Nm	4.5	4.5
Add-on services – Auxiliary contacts					yes	yes
Add-on services – Tele U					yes	yes
Add-on services – Tele L					yes	yes
Busbar systems – pin (top/bottom) (non-UL)					yes/yes	yes/yes
Busbar systems – fork (top/bottom) (non-UL)					-/yes	-/yes
Accessories					yes	yes
Dimensions, weights, packaging	(HxDxW) 86x68xW		mm/mod	18	18	18
	Weight/mod		g	120	120	125
	Package		mod.	12	12	12
Approvals					KEMA	KEMA
CE-marking					yes	yes

MOLDED CASE
CIRCUIT BREAKERS
3



Miniature Circuit Breakers and Supplementary Protectors Accessories

Terminals (Lugs) for Q Line Circuit Breakers				GO-135B
Ampere Rating	Termination Type	Wire Range (Cu/Al)	Product Number	List Price
15-60	Lug (line only)	14-6/12-2	TOAL3A	\$1.50
15-60	Lug (load only)	14-2/12-2	THOEL3	\$1.50
15-60	Quick connector (load only)	(4) 14/(4) 12	THQECC	\$2.50

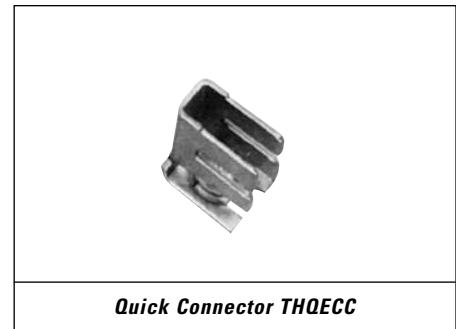

Internal Accessories for TEY (2- and 3-pole breaker only) Factory Installed Only			GO-135B
Auxiliary Switch, Single-Pole (6A at 240 Vac, 1/2A at 125 Vdc, 1/4A at 250 Vdc)	Add suffix to Breaker Product Number		List Price Adder
"A" switch (normally open)	AS1A		\$148.00
"B" switch (normally closed)	AS1B		\$148.00
"AB" switch (both)	ASAB		\$288.00
Shunt Trip 120-277 Vac control voltage	ST12		\$358.00

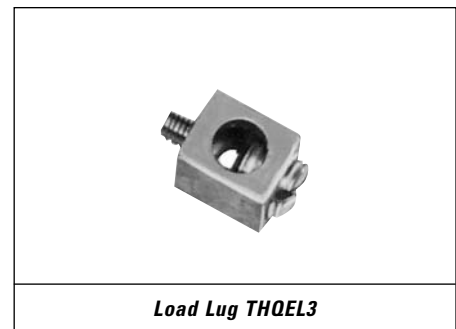

Mounting Accessories for THQB, THQC, TEY					GO-135B
Product Type	Ampere Rating	# of Poles	Used With Frame	Product Number	List Price
Bolt-on Mounting Base		3	TEY THQB	TEY3B	\$31.50
Back Mounting Plates Screw Type		1	THQC	TQCBMPA1	\$8.30
Back Mounting Plates Screw Type		2	THQC	TQCBMPA2	\$9.80
Back Mounting Plates Screw Type		3	THQC	TQCBMPA3	\$12.00
Back Mounting Plates Screw Type		10	THQC	TQCBMPA10	\$32.00
Front-mounting Plates		1	THQC	TQCFMP1 ¹	\$8.30
Front-mounting Plates		2	THQC	TQCFMP2 ¹	\$9.80
Front-mounting Plates		3	THQC	TQCFMP3 ¹	\$12.00
Front-mounting Plates		4	THQC	TQCFMP4 ¹	\$14.00
Front/Rear Mounting Clips	15-60A	1 & 2	THQC	THOCFMPK ²	\$48.00
DIN rail clips	15-60A	1 & 2	THQC	THQCDIN ²	\$24.00

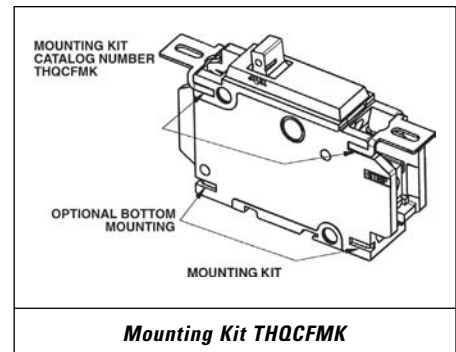

¹Not UL listed.
²Price is per pack.

Mounting Accessories for THQC, THQC-GF, GFEP, AF					GO-133
Product Type	# of Poles	Used With Frame	Product Number	List Price	
Snap In Back Mounting Plates	1	THQC, THQC-GF	TQCGFBMPA1	\$6.10	
Snap In Back Mounting Plates	2	THQC, THQC-GF	TQCGFBMPA2	\$7.60	
Snap In Back Mounting Plates	3	THQC, THQC-GF	TQCGFBMPA3	\$9.10	
Snap In Back Mounting Plates	10	THQC, THQC-GF	TQCGFBMPA10	\$25.00	

Mounting Accessories for TQL					GO-134A
Product Type	Ampere Rating	# of Poles	Used With Frame	Product Number	List Price
Plug-in Mounting Base	70 amp	2	TQL	571B595DDG1	\$23.75
Plug-in Mounting Base	70 amp	3	TQL	571B595DDG2	\$32.00
Plug-in Mounting Base	100 amp	3	TQL	565B837G1	\$38.00
Plug-in Mounting Base	100 amp	2	TQL	565B837G2	\$23.75

MOLDED CASE CIRCUIT BREAKERS

3



Miniature Circuit Breakers and Supplementary Protectors Accessories

Handle Locking Devices			GO-135B
Product Type	Used With Frame	Product Number	List Price
Handle Locks - Non Padlocking	TQC TOB TOQ	THL103	\$6.50 ¹
Handle Locks - Non Padlocking	THOP	TOPL	\$5.50 ¹
Handle Locks - Non Padlocking	TEY	TEYLD1	\$5.00
Handle Locks - Non Padlocking	E150 Line	TLD3	\$5.00
Handle Locks - Non Padlocking	THLC2, 4 F225 Line	TFKLD1	\$6.00
Handle Locks - Non Padlocking	SF250 SE150	SBD1	\$4.70 ²

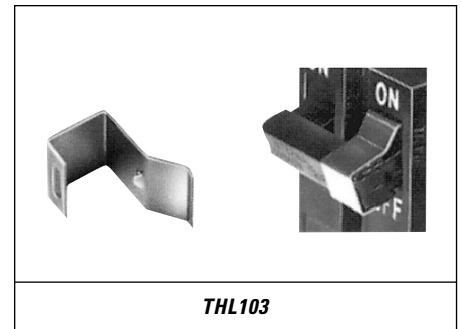

Handle Locking Devices			GO-137A
Product Type	Used With Frame	Product Number	List Price
Handle Locks - Padlocking	TQD	TQDPLD1 ³	\$20.75
Handle Locks - Padlocking	TQDL	TQDLPLD1 ³	\$17.75
Handle Locks - Padlocking	TQB TOQ	THP100	\$6.50 ¹
Handle Locks - Padlocking	THOP	TOPL	\$5.75

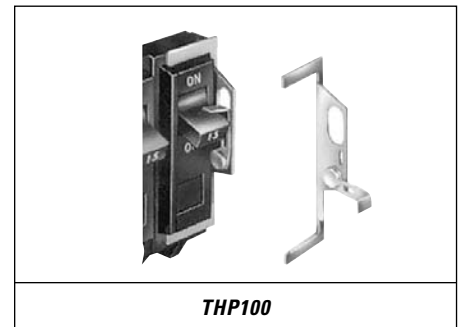

Handle Locking Devices			GO-135B
Product Type	Used With Frame	Product Number	List Price
Handle Locks - Padlocking	TQC	TOPLD1 ³	\$4.70
Handle Locks - Padlocking	TEY	TEYPLD1	\$9.00
Handle Locks - Padlocking	E150 TB1	TEFPLD1	\$8.00
Handle Locks - Padlocking	THLC1	TLC1PLD1	\$17.00
Handle Locks - Padlocking	F225	TFKPLD1	\$4.00
Handle Locks - Padlocking	THLC2 THLC4 TLB4	TLC4PLD1	\$22.00
Handle Locks - Padlocking	J600 Line	TJKPLD1	\$8.00
Handle Locks - Padlocking	K1200 Line	TKMPLD1	\$28.50

Handle Locking Devices			GO-135S
Product Type	Used With Frame	Product Number	List Price
Handle Locks - Padlocking	SF250 SE150	SEPLD ³	\$8.70
Handle Locks - Padlocking	SG600	SGPLD ³	\$15.00
Handle Locks - Padlocking	SK1200	SKPLD ³	\$28.50

¹GO-137A.

²GO-135S.

³Suitable for circuit breakers used in group mounted panelboard construction only except for J600, K1200, SE150/SE250, SG600 and SK1200 which screw down to face of breaker.

www.DataSheet4U.com

Publications and Reference: See Section 21 for a list of additional product-related publications



www.DataSheet4U.com

MOLDED CASE
CIRCUIT BREAKERS
3

Miniature Circuit Breakers and Supplementary Protectors
Accessories

Handle Locking and Handle Extension Devices EUSERC Approved —
Factory Installed Only **GO-135B**

Product Type	Used With Frame	Product Number	List Price
Handle Locks - Padlocking		TQDPLD2	\$32.00
Handle Locks - Padlocking		TEDPLD2	\$32.00
Handle Locks - Padlocking		TJKPLD2	\$48.00
Handle Locks - Padlocking		THLC1PLD2	\$48.00
Handle Locks - Padlocking		THLC4PLD2	\$48.00
Handle Locks - Padlocking		SEFPLD2	\$32.00 ^{1,2}
Handle Locks - Padlocking		SGPLD2	\$48.00 ¹
Handle Locks - Padlocking		SKPLD2	\$60.00 ¹

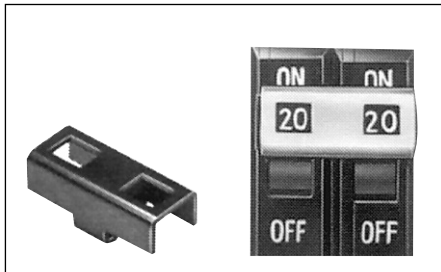

THT1

Handle Locking and Handle Extension Devices **GO-137A**

Product Type	Used With Frame	Product Number	List Price
Snap-on Handle Tie - open	THQP	THT2 ³	\$2.30
Snap-on Handle Tie - solid	TQL	THT104	\$2.30
Snap-on Handle Tie - solid, indicating	THQP	THT1	\$2.30
Snap-on Handle Tie - trip indicating	TQC	TOHT1	\$2.30
Handle Extension - replacement	SK1200	SKHDLEXT	\$96.50 ¹

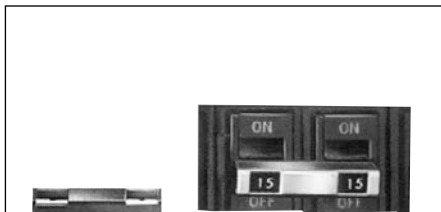

THT104

Breaker Mounting Screw Kits **GO-135B**

Product Type	Used With Frame	Product Number	List Price
Breaker Mounting Screw Kits	THQB	TQBS1 ⁴	\$6.00

¹GO-135S.

²Field Installable

³For 2 THQPs separated by 2 side-by-side THQPs.

⁴Price is per screw. Packaged in quantities of 24. Must be ordered in multiples of 24.

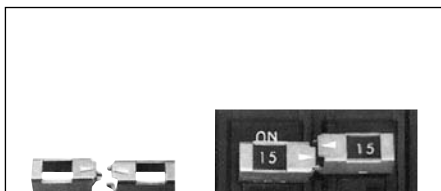

TQHT1



THT2

MOLDED CASE
CIRCUIT BREAKERS

3

www.DataSheet4U.com



Industrial Circuit Breakers

Spectra RMS, Spectra RMS with MicroVersaTrip Plus Trip Units, Spectra RMS with MicroVersaTrip PM Trip Units, Thermal Magnetic and J/K with MicroVersaTrip RMS-9 and Power+ 4 Trip Units

How to Order

Spectra RMS

—Circuit Breakers

Determine the required breaker frame, IC rating, and load requirements. Select frame, trip unit (rating plug), and lug, if required, product numbers from the tables on pages 3-48 to 3-58. For Spectra breakers with MicroVersaTrip Plus Trip Units or MicroVersaTrip PM Trip Units refer to pages 3-59 through 3-61. Select field-mounted internal accessory product numbers, if required, on pages 3-83 and 3-84. Select field-mounted external accessory product numbers, if required, on pages 3-92 through 3-104. Order as separate items.

—Mag-Break Motor Circuit Protectors

Determine the required frame and ampere requirements. Select frame, trip unit (rating plug), and lug, if required, product numbers from the table on pages 3-73 through 3-75. Select accessories as noted above for circuit breakers. The same accessories are used with both circuit breakers and motor circuit protectors. Order as separate items.

—Molded Case Switches

Determine the required frame and ampere requirements. Select frame and lug, if required, product numbers from the table on page 3-72. Rating plugs are not used. Select accessories as noted above for circuit breakers. Internal accessories do not require dummy trips. The same accessories are used with both circuit breakers and molded case switches. Order as separate items.

Unless otherwise noted, all circuit breakers are UL listed in File E-11592. Molded case switches are UL listed in File E-57546.

Field-Installable Internal Accessories are UL listed in File E-57253. Distribution Cable Accessories for MicroVersaTrip Plus Trip Units and MicroVersaTrip PM Trip Units are UL listed in File E-57253.

E 150 Line

- Thermal Magnetic Circuit Breakers
- Magnetic Circuit Breakers
- Molded Case Switches

The product numbers as shown in the following pages include the complete breaker or switch. All devices listed come with Cu/Al line and load lugs. If line lugs are not required on a breaker, eliminate "WL" from product number; for molded case switches see page 3-38. Unless otherwise noted, all circuit breakers are UL listed in File E-11592. Molded case switches are UL listed in File E-57546.

F 225 Line

- Thermal Magnetic Circuit Breakers
- Magnetic Circuit Breakers
- Molded Case Switches

These breakers are available with either noninterchangeable trips (designated Type TFJ) or interchangeable trips (designated Types TFK/THFK). When ordering Type TFJ, product number includes complete breaker, trip unit, CU/Al line and load lugs factory

assembled. If line lugs are not required on a breaker, eliminate "WL" from product number, and subtract price of line lugs from price of complete breaker. If interchangeable trip (Types TFK/THFK) is required order one of two ways. "Complete circuit breaker" price includes frame, trip, Cu/Al line and load lugs. Units will be shipped unassembled unless specified on order "must be factory assembled." If line lugs are not required on a breaker, eliminate "WL" from product number, and subtract price of line lugs from price of complete breaker. To order the frame, trip, and lugs separately, select the required components from table. Magnetic breakers must be ordered as components. A complete breaker consists of frame, trip unit, one line lug per pole and one load lug per pole. Price of "Complete Circuit Breaker" vs. ordering frame, trip, and line and load lugs separately is the same.

Molded case switches can also be ordered as complete units (designated TFK---Y) or as separate components. They are UL listed only as complete units. To indicate required lugs, see page 3-38.

Unless otherwise noted, all circuit breakers are UL listed in File E-11592. Molded case switches are UL listed in File E-57546.

J 600 Line

- Thermal Magnetic Circuit Breakers
- Magnetic Circuit Breakers
- Molded Case Switches

These breakers are available with either noninterchangeable trip (designated Type TJJ) or interchangeable trip (designated Type TJK and THJK). Type TJJ product numbers include frame, trip, Cu/Al line, and load lugs factory assembled. If line lugs are not required on the breaker, eliminate "WL" from product number, and subtract price of line lugs from price of complete breaker.

TJK breakers are available in two frames, 400 ampere frame (125 to 400 amperes) and 600 ampere frame (250 to 600 amperes). Trip units are not interchangeable between frames.

"Complete Circuit Breaker" price includes frame, trip unit, Cu/Al line, and load lugs. Unit will be shipped unassembled unless order specifies "must be factory assembled." If line lugs are not required, eliminate "WL" from product number and subtract price of line lugs from price of complete breaker.

To order the frame, trip, and lugs separately, select the required components from table. Magnetic breakers must be ordered as components. A complete breaker consists of frame, trip, and one line and one load lug per pole.

Price of ordering "Complete Circuit Breaker" vs. frame, trip, and line and load lugs separately is the same.

Molded case switches can also be ordered as complete units (designated Type TJK---Y) or as separate components. They are UL listed only as complete units. To indicate required lugs, see page 3-38.

Unless otherwise noted, all circuit breakers are UL listed in File E-11592. Molded case switches are UL listed in File E-57546.

Publications and Reference: See Section 21 for a list of additional product-related publications



Industrial Case Circuit Breakers

K 1200 Line

- Thermal Magnetic Circuit Breakers
- Magnetic Breakers
- Molded Case Switches

These breakers are available only with interchangeable trip units. Two frame sizes are available, the 800 ampere frame (300 to 800 amperes) and the 1200 ampere frame (600 to 1200 amperes). Trip units are not interchangeable between frames.

“Complete Circuit Breaker” price includes frame, trip, Cu/Al line, and load lugs. Units will be shipped unassembled unless specified “must be factory assembled.” If line lugs are not required on the breaker, eliminate “WL” from product number and subtract price of line lugs.

To order the frame, trip, and lugs separately, select the required components from table. Magnetic circuit breakers must be ordered as components. A complete breaker consists of frame, trip and one line and one load lug per pole. Price of ordering “Complete Circuit Breaker” vs. frame, trip, and line and load lugs separately is the same.

Molded case switches can also be ordered as complete units (designated Type TKMA---Y) or as separate components. They are UL listed only as complete units. To indicate required lugs, see the table below.

Unless otherwise noted, all circuit breakers are UL listed in File E-11592. Molded case switches are UL listed in File E-57546.

R Frame—1000/1600/2000 Ampere Molded Case Circuit Breakers

- Solid-state MicroVersaTrip Plus or MicroVersaTrip PM Trip Unit
- Interchangeable trip unit via rating plugs
- 65 and 100 kA ratings available
- Standard and 100% rated versions
- Uses standard Power Break accessories
- Stationary/manual only

Circuit Breakers with MicroVersaTrip Trip Units

- Solid-state construction with MicroVersaTrip Plus digital rms sensing microprocessor trip units.
- Available in J and K frame construction with ampere ratings from 60-1200A.

For ordering information see pages 3-80 through 3-82. UL listed, File E-11592. All breakers are UL listed in File E-11592.

Tri-Break Line

- Integrally Fused Thermal Magnetic Circuit Breakers
- Integrally Fused Magnetic Circuit Breakers
- Integrally Fused Molded Case Switches

These breakers are available in four types. Type TB1 (15-100 amperes) product numbers include frame, trip, line and load lugs, and current limiters all factory assembled. Types TB4 (125 to 400 amperes), TB6 (300 to 600 amperes) and TB8 (600 to 800 amperes) include frame, trip and limiters, factory assembled, but do not include line or load lugs. If line and load lugs are required, order separately. Unless otherwise noted, TB1, TB4, TB6, and TB8 breaker components are UL listed in File E-42263. Fused molded case switches are UL listed in File E-57546.

Mag-Break Line

- Magnetic only circuit breakers (motor circuit protectors)

These breakers are available only with noninterchangeable adjustable magnetic trip, in frame Types E, F, J, K, and Tri-Break. All breakers are shipped factory assembled, complete with Cu/Al line and load lugs.

All magnetic only circuit breakers and limiters are UL Component Recognized in Files E-11592 and E-66390, respectively, unless otherwise noted.

Accessories

Order accessories from the appropriate table:

- Thermal Magnetic Circuit Breakers, Magnetic Circuit Breakers, and Molded Case Switches¹—pages 3-85 to 3-104.
- MicroVersaTrip Plus or Power+ 4-function J and K frame Solid State Circuit Breakers—pages 3-85 to 3-104.
- Spectra RMS Breakers—pages 3-83 to 3-84 and 3-92 to 3-104.
- Spectra RMS Breakers with MicroVersaTrip Plus Trip Units or MicroVersaTrip PM Trip Units—pages 3-83 to 3-84, 3-92 to 3-104 and 3-106 to 3-109.

¹Installation of accessories in molded case switches requires dummy trip; see page 3-91 for information. Dummy trip not required for Tri-Break or Q Line molded case switches.

Molded Case Circuit Breaker and Switch Terminal Configuration Code

Order standard Cu/Al lugs by using suffix codes presented. Order lugs separately if special lugs are required. For optional lugs, see pages 3-101 and 3-102.

Breaker/Switch Type	Suffix				
	Blank	WL	XL	X2	LL
TQD/TJD	Load Lugs Only	Line and Load Lugs	—	Line Lugs Only	No Lugs
Molded Case Breakers, Thermal Magnetic	Load Lugs Only	Line and Load Lugs	—	Load Lugs Only	No Lugs
Molded Case Switch	Line and Load Lugs	—	No Lugs	Line Lugs Only	Load Lugs Only
Spectra RMS™ Breakers	No Lugs			Order Lugs Separately	
J,K, MicroVersaTrip® Breakers	No Lugs			Order Lugs Separately	
Mine Duty™ Breakers	No Lugs			Order Lugs Separately	
Mag-Break® Breakers	Line and Load Lugs	—	—	—	—

For E 150 circuit breakers suffix XL is used to specify “no lugs”.



Industrial Circuit Breakers

How To Order

Spectra RMS Circuit Breakers with MicroVersa Trip Plus Trip Units

How to Order

- Determine the required breaker frame (i.e., 150, 400, 600, 800, or 1200 amperes), IC rating, and load requirements (UL Standard or 100%). Determine overcurrent protective functions (LI, LSI, LIG, LSIG). Select frame product number and list price from table on pages 3-59 to 3-61 and 3-66 to 3-68.
- Select and price the required rating plug from table below. The sensor rating of frame must match the sensor rating of the rating plug in table.
- Select and price lugs and lug covers as required from page 3-102 and 3-103.
- Select and price appropriate combination of Power Management System accessories from pages 3-106 to 3-109.
- Select and price any other accessories from pages 3-83 to 3-84 and 3-92 to 3-100.
- When ordering, specify separate product numbers as follows:
 - Frame
 - Rating Plug
 - Lugs
 - Power Management Accessories
 - Other Accessories

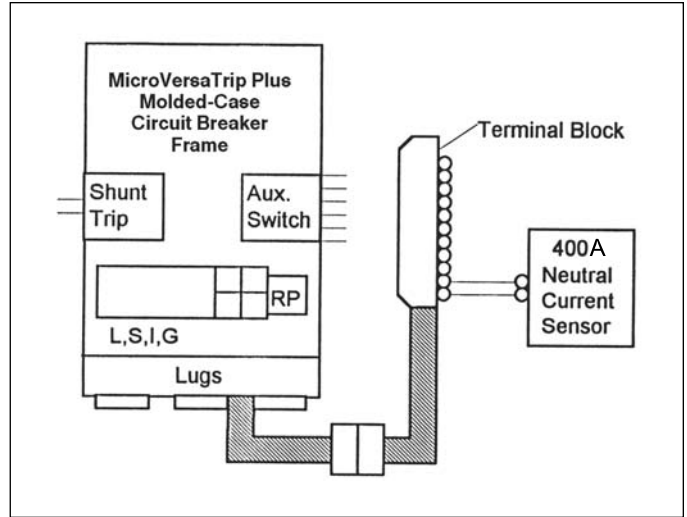

Note: All Spectra RMS breakers with ground fault option will have a breaker cable. If the breaker is connected to a 3Ø4w or 1Ø3w service, a terminal block or junction box is required for connection to the neutral current sensor.

Trip Function Definitions

Long-Time (L)	Adjustable current setting Adjustable long-time delay
Short-Time (S)	Adjustable short-time pick-up Adjustable short-time delay with I2t Adjustable short-time delay without I2t
Instantaneous (I)	Adjustable pick-up
Ground Fault (G)	Adjustable ground fault pick-up adjustable ground fault delay with I2t Adjustable ground fault delay without I2t
Control Power (CP)	+24 Vdc control power connection

Pricing Example

SG600 frame, 400 ampere sensor, 400 ampere rating plug, 100kAIC, 100% rated. Trip functions to include long-time (L), short-time (S), instantaneous (I) and ground fault. 3-phase/4 wire system with 400 ampere neutral sensor. Load lugs only. 120 Vac shunt trip and two stage auxiliary switch (2AB) with signal level contacts.

Description	Product Number	List Price GO-135S
Frame	SGPP36BD0400	\$8987.00
Rating Plug	SRPG400B400	\$106.00
Load Lugs (3 pole kit)	TCLK365	\$42.00
Terminal Block	SDCTBA11	\$110.00 ¹
400A neutral sensor	TSRG204	\$532.00
120 Vac Shunt Trip	SAST1	\$363.00
2AB Aux. Switch	SAUXGAB2	\$295.00

¹GO-135PM.

MicroVersa Trip Plus and PM Rating Plug Selection — All Plugs List Price, \$106.00

Circuit Breaker Frame	Sensor Rating	Rating Plug Rating (Amperes)	Rating Plug Product No.	
SGHB, SGHH, SGLB, SGLL, SGPB, SGPP	150	60	SRPG150B60	
		80	SRPG150B80	
		100	SRPG150B100	
		125	SRPG150B125	
		150	SRPG150B150	
		150	SRPG400B150	
	SKHB, SKHH, SKLB, SKLL, SKPB, SKPP	400	200	SRPG400B200
			225	SRPG400B225
			250	SRPG400B250
			300	SRPG400B300
			350	SRPG400B350
			400	SRPG400B400
SKHB, SKHH, SKLB, SKLL, SKPB, SKPP		600	300	SRPG600B300
			400	SRPG600B400
			450	SRPG600B450
			500	SRPG600B500
			600	SRPG600B600
			300	SRPK800B300
	SKHB, SKHH, SKLB, SKLL, SKPB, SKPP	800	400	SRPK800B400
			500	SRPK800B500
			600	SRPK800B600
			700	SRPK800B700
			800	SRPK800B800
			600	SRPK1200B600
1200		700	SRPK1200B700	
		800	SRPK1200B800	
		1000	SRPK1200B1000	
		1200	SRPK1200B1200 ²	

²Not suitable for use with 100% rated, 1000A breaker frame.

MOLDED CASE CIRCUIT BREAKERS 3

Publications and Reference: See Section 21 for a list of additional product-related publications



Industrial Circuit Breakers

**Spectra RMS Circuit Breakers with
MicroVersaTrip PM Trip Units**

MicroVersaTrip PM Trip Unit

The MicroVersaTrip PM trip unit adds power management system capability, advanced metering, and protective relays to the basic functions of MicroVersaTrip Plus. MicroVersaTrip PM trip units communicate directly on the GE POWER LEADER communications bus. Suitable for use in applications from 45 Hz to 66 Hz. Not suitable for 400 Hz.

Standard Features

- Adjustable Long-Time (L) pickup, 0.5-1.0X, and delay (3-4 bands).
- Adjustable Instantaneous (I) pickup, 1.5-10X.
- Local Overload and Short-Circuit Trip Indicators (T) with overload pickup warning.
- Interchangeable trip rating plugs with test set jack for TVRMS test set.
- Digital LCD display with four-button keypad for function selection and set point adjustment and sealable, clear Lexan cover for tamper-resistant settings.
- True rms sensing for accurate response to high harmonic content waveforms.
- EMI immunity per ANSI C37.90.
- POWER LEADER Communications System Link with user-selectable address assignment for COMNET communication.
- Metering
 - 3-Phase Ammeter with $\pm 4\%$ accuracy.
 - 3-Phase Voltmeter, $\pm 2\%$ @ 1X, configurable for Wye and Delta systems.
 - Frequency Meter, ± 1 Hz
 - kW Meter, $\pm 7\%$ (real power)
 - kVA Meter, $\pm 6\%$ (apparent power)
 - kWh Meter, $\pm 6\%$ (energy)

Control Power 24 Vdc provides connection capability for +24 Vdc control power into the breaker via the distribution cable system.

Optional Features

- Adjustable Short-Time (S) pickup, 1.0-9.0C, and delay (4 bands) with I^2t IN/OUT selection.
- Adjustable Ground fault (G) pickup, 0.2-1.0S, and delay (4 bands) with I^2t IN/OUT selection and trip indicator. The 4 short-time and ground fault delay bands provide broader system selectivity.
- Protective Relays—User selectable in any combination from 1 to 5 relays
 - Current Unbalance Relay
 - Undervoltage Relay
 - Overvoltage Relay
 - Voltage Unbalance Relay
 - Power Reversal Relay



Note: MicroVersaTrip PM functions require 24 Vdc control power and voltage sensing signals.

Universal Internal Accessories—Uses the same front-mounted, field-installable shunt trips, undervoltage releases, bell alarms, and auxiliary switches as standard Spectra RMS breakers.

Accessory Lead Routing Left or Right—Side channels mean no extra space required for accessory leads.

Current Limiting—SG600 frames rated 65kA and 100kA @ 480 Vac are UL listed as current limiting.

Reverse Feed—Front-mounted interchangeable rating plugs mean all frames are UL listed for reverse feed.

Wide Current Setting Range—Interchangeable rating plugs combined with 5 current sensors and 0.5-1.0X long time pickup yield ampere ratings from 30 to 1200A.

100% Continuous Current Rated—Optionally available for 100% UL continuous current rating applications.



Industrial Circuit Breakers
Spectra RMS Circuit Breakers with
MicroVersaTrip PM Trip Units

MicroVersaTrip PM Trip Unit Characteristics

Current Setting (C) Pickup (Multiple of Rating Plus Amperes) (X)	Long-Time ¹		Short-Time		Adjustable Instantaneous Pickup (Multiple of Rating Plug Amperes) (X)	Ground Fault	
	Delay (Seconds)	Pick-Up (Multiple of Current Settings) (C)	Delay (Seconds)	Pick-Up (Multiple of Sensor Ampere Rating) (S)		Delay (Seconds)	
0.50 to 1.0 in increments of 0.05 (11 Settings)	2,4,4.9,9,8,20 ^{2,3} (3-4 Bands)	1.5 to 9.0 in increments of 0.5 (16 Settings)	I^2t IN ³ 0.44 I ^{2t} OUT ⁴ 0.1, 0.2, 0.3, 0.4 (8 Bands)	1.5 to 10.0 in increments of 0.5 (18 Settings)	0.2 to 1.0 in increments of 0.05 (17 Settings)	I^2t IN ⁵ 0.41 I ^{2t} OUT ⁴ 0.1, 0.2, 0.3, 0.4 (8 Bands)	

X = Rating Plug Amperes

S = Sensor Ampere Rating

C = Long-Time Current Settings (Pickup)

C = X Times Long-Time Pickup Setting

¹ Pick-up fixed at 1.1C.

² 20-second delay (band) not available on SG frames.

³ Time delay at 600% of current setting at lower limit of each band.

⁴ Time delay shown at lower limit of each band. Pickup tolerances ± 10%. Ground Fault Pick-up not to exceed 1200 amperes.

⁵ Time delay at 200% of pickup setting at the lower limit of each band.

Functions	Accuracy and Description	PM Trip Unit	
		Metering (M)	Metering and Relaying (PM)
Amperes (A)	Current ±4% Selectable Phase	•	•
Voltage (V)	Volts ±2% Selectable Phase in L-L or L-N	•	•
Energy (kWh/MWh)	Watt hours ±7% Total energy flow through breaker	•	•
Real Power (kW/MW)	Watts ±6% L-L or L-N Power	•	•
Apparent Power (kVA/MVA)	Volt amps ±6% L-L or L-N Power	•	•
Frequency (45-66 Hz)	Hertz ±6%	•	•
Voltage Unbalance Relay	Adjustable pickup, 10 to 50% Adjustable delay, 1 to 15 seconds or OFF		•
Current Unbalance Relay	Adjustable pickup, 10 to 50% Adjustable delay, 1 to 15 seconds or OFF		•
Undervoltage Relay	Adjustable pickup, 50 to 90% Adjustable delay, 1 to 15 seconds or OFF		•
Overvoltage Relay	Adjustable pickup, 110 to 150% Adjustable delay, 1 to 15 seconds or OFF		•
Power Reversal Relay	Adjustable pickup, 0.01 MW to .90 MW Adjustable delay, 1 to 15 seconds or OFF		•
Communications	POWER LEADER™ Communications System Link (comment)	•	•

www.DataSheet4U.com

Publications and Reference: See Section 21
for a list of additional product-related publications



www.DataSheet4U.com

**MOLDED CASE
 CIRCUIT BREAKERS**
3

Industrial Circuit Breakers

Spectra RMS Circuit Breakers with MicroVersaTrip PM Trip Units

How to Order

- Determine the required breaker frame (i.e., 150, 400, 600, 800, or 1200 amperes), IC rating, and load requirements (UL Standard or 100%). Determine overcurrent protective functions (LI, LSI, LIG, LSIG) and whether protective relaying is required. Select frame product number and list price from table on pages 3-59 to 3-61 and 3-66 and 3-68.
- Select and price the required rating plug from table below. The sensor rating of frame must match the sensor rating of the rating plug in table.
- Select and price lugs and lug covers as required from page 3-102 and 3-103.
- Select and price appropriate combination of Power Management System accessories from pages 3-106 to 3-109.
- Select and price an auxiliary switch as required from page 3-109.
- Select and price any other accessories from pages 3-83 to 3-84 and 3-92 to 3-100.
- When ordering, specify separate product numbers as follows:
 - Frame
 - Rating Plug
 - Lugs
 - Auxiliary Switch
 - Power Management System Accessories
 - Other Accessories

Trip Unit Function Definitions

Long-Time (L)	Adjustable current setting Adjustable long-time delay
Short-Time (S)	Adjustable short-time pick-up Adjustable short-time delay with I ² t Adjustable short-time delay without I ² t
Instantaneous (I)	Adjustable pick-up
Ground Fault (G)	Adjustable ground fault pick-up Adjustable ground fault delay with I ² t Adjustable ground fault delay without I ² t
Trip Indication Targets	Standard
Full Metering (Standard)	Amperes (A/kA) – Phase Selectable Voltage (V) – L-L or L-N and Phase Selectable Energy (kWh/MWh) Real Power (kW) – L-L or L-N Total Power (kVA) – L-L or L-N Frequency (45-66 Hz)
Protective Relay Functions	Adjustable Undervoltage pick-up Adjustable Undervoltage delay or OFF Adjustable Overvoltage pick-up Adjustable Overvoltage delay or OFF Adjustable Voltage Unbalance pick-up Adjustable Voltage Unbalance delay or OFF Adjustable Current Unbalance pick-up Adjustable Current Unbalance delay or OFF Adjustable Power Reversal pick-up Adjustable Power Reversal delay or OFF

Pricing Example

SG600 ampere frame breaker, 100% UL rated with 400 ampere sensors and 400 ampere rating plug with line and load lugs. Trip functions to include adjustable long-time (L), short-time (S), instantaneous (I) and equipment ground fault (G) and internal protective relay functions of current unbalance (CU), voltage unbalance (VU), undervoltage (UV),

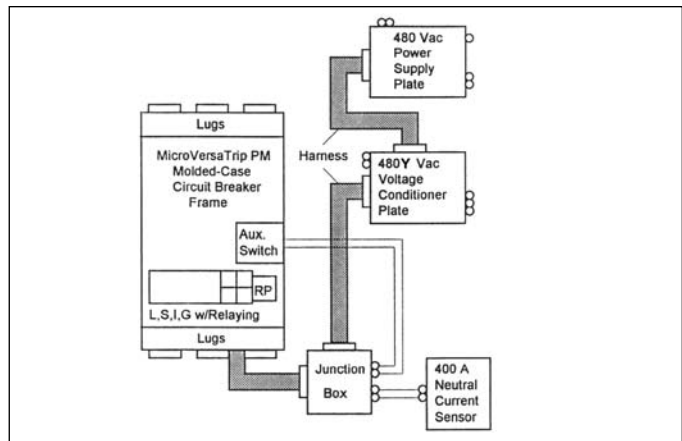

overvoltage (OV) and power reversal (PR). Local metering values available at the breaker shall include Current (Amperes), Voltage (Volts), Energy (kWh), Real Power (kW), Apparent Power (kVA) and Frequency (Hz). The available system is 277/480 Vac, 3-phase/4-wire with 100 kAIC fault current available. The Distribution Cable Accessories are to be mounted on plates with all the necessary fuse protection, potential transformers, control power transformers, etc.

Description	Product Number	List Price	GO Schedule
Frame	SGPP36DD0400	\$11387.00	135PM
Rating Plug	SRPG400B400	\$106.00	135S
Line and Load Lugs (2-3 Pole Kits)	TCLK635	\$42.00	135S
Auxiliary Switch	SAUXPAB1	\$149.00	135S
Power Supply Plate	SPSA480	\$1215.00	135PM
Voltage Conditioner Plate	SVCA480Y	\$1000.00	135PM
Junction Box	SDCJBA	\$155.00	135PM
Harness (2)	SPCHA11	\$140.00	135PM
400A Neutral Current Sensor	TSRG204	\$532.00	135S

MicroVersaTrip Plus and PM Rating Plug Selection— All Plugs List Price, \$106.00

Circuit Breaker Frame	Sensor Rating	Rating Plug Rating (Amperes)	Rating Plug Product No.
SGHB, SGHH, SGLB, SGLL, SGPB, SGPP	150	60	SRPG150B60
		80	SRPG150B80
		100	SRPG150B100
		125	SRPG150B125
		150	SRPG150B150
		150	SRPG400B150
	400	200	SRPG400B200
		225	SRPG400B225
		250	SRPG400B250
		300	SRPG400B300
		350	SRPG400B350
		400	SRPG400B400
SKHB, SKHH, SKLB, SKLL, SKPB, SKPP	600	300	SRPG600B300
		400	SRPG600B400
		450	SRPG600B450
		500	SRPG600B500
		600	SRPG600B600
		300	SRPK800B300
	800	400	SRPK800B400
		500	SRPK800B500
		600	SRPK800B600
		700	SRPK800B700
		800	SRPK800B800
		600	SRPK1200B600
1200	700	SRPK1200B700	
	800	SRPK1200B800	
	1000	SRPK1200B1000	
	1200	SRPK1200B1200 ¹	

¹Not suitable for use with 100% rated, 1000A breaker frame.

MOLDED CASE CIRCUIT BREAKERS

3



Industrial Circuit Breakers

R-Frame Molded Case Circuit Breakers
Solid-State Interchangeable Trip
400-2000A, 600 Vac, 65,100 kAIC @480V
Standard and 100% Rated
MicroVersaTripPlus
Suitable for Reverse Feed

How To Order:

1. Select frame product number.
2. Select rating plug for current rating from page 3-71.
3. Select appropriate accessories and lugs from page 3-105.
 Include suffix "s" for factory installation.

Example

Description	Product Number
Frame	TRPP36BD10
Rating Plug	TR10B600
Neutral CT	TSVG810A
Shunt Trip	TPST12
Auxiliary Switch	TPAS2AB4
Padlocking Provision	Standard
Line Side Terminations (Optional)	(3)TP16FCA
Load Side Terminations Adapter Kit	(1)TPLUGA16
Lugs (2 per pole)	(6)TPLUG108

R-Frame UL Listed Interrupting Ratings - rms Symmetrical Amperes

Frame Type	Continuous Current Rating		Interrupting Rating (rms sym.)
	80%	100%	
Standard Break	LA	LL	240 Vac 100,000 Amperes
			480 Vac 65,000 Amperes
			600 Vac 50,000 Amperes
Hi-Break®	PA	PP	240 Vac 125,000 Amperes
			480 Vac 100,000 Amperes
			600 Vac 65,000 Amperes

MicroVersaTrip Plus Trip Unit Selection Trip Unit Function Definitions

Long-Time (L)	Adjustable current setting Adjustable long-time delay
Short-Time (S)	Adjustable short-time pick-up Adjustable short-time delay with I ² t Adjustable short-time delay without I ² t
Instantaneous (I)	Adjustable pick-up
Ground Fault (G)	Adjustable ground fault pick-up Adjustable ground fault delay with I ² t Adjustable ground fault delay without I ² t
Trip Indication Target (T1, T2)	Overload/short circuit targets (T1) Overload/short circuit/ground fault targets (T2)
Zone Selective Interlock (Z1, Z2)	Ground fault (Z1) Ground fault/short-time (Z2)

Trip Unit Functions Available

R-Frame Breaker Function Code	Long Time (L)	Short Time (S)	Instantaneous (I)	Ground Fault (G) ¹	Targets (T)		Zone Interlock GF (Z1) ²	Zone Interlock GF, ST (Z2)
					OL, SC	OL, SC, GF		
A	•	—	•	—	•	—	—	—
B	•	•	•	—	•	—	—	—
C	•	—	•	•	—	•	—	—
D	•	•	•	•	—	•	—	—
E	•	—	•	•	—	•	•	—
F	•	•	•	•	—	•	•	—
G	•	•	•	•	—	•	—	•

¹ For single-phase, 3-wire or 3-phase, 4-wire GF applications select neutral-current sensor on page 3-105.
² Zone interlocking requires purchase of interlock module TIM1 (120 Vac control voltage).

Frame Selection:

IC and UL Current Rating
 Standard Break
 Hi-Break
 100% Standard Break
 100% Hi-Break

Trip Unit Type
 MicroVersaTrip Plus
 MicroVersaTrip PM w/o Protective Relays
 MicroVersaTrip PM with Protective Relays

Trip Unit Functions

LIT
 LSIT
 LIGT
 LSIGT
 LIGTZ1
 LSIGTZ1
 LSIGTZ2

Current Sensor

1000 A
 1600 A
 2000 A

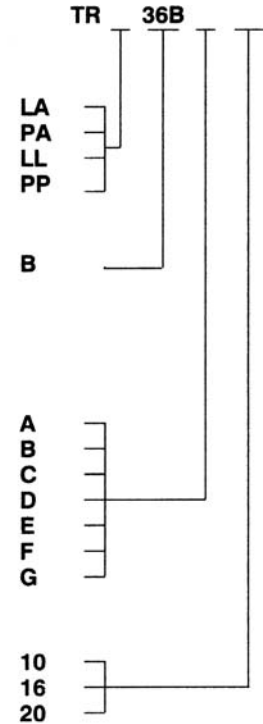

MOLDED CASE CIRCUIT BREAKERS

3

Publications and Reference: See Section 21 for a list of additional product-related publications

Industrial Circuit Breakers

15-1200A Circuit Breakers Electric Trip Spectra RMS Breakers Quick Reference Guide

Ratings do not apply to molded case switches. The interruption ratings and voltages shown in the table are maximum ratings. A circuit breaker of the type given in the left-hand column may be applied at the given circuit voltage in any electrical distribution system where the available fault current at the load terminals of the breaker does not exceed the value in the table. That circuit breaker type may also be applied at intermediate values of circuit voltage provided the available fault current at the load terminals of the breaker does not exceed the value in the table for the higher value of voltage.

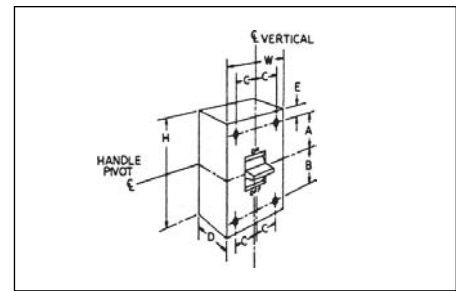

Spectra RMS Circuit Breakers UL/CSA Ratings

Solid-State with Interchangeable Trip Unit (Rating Plug)

Circuit Breaker Type	Ampere Rating	No. Poles	Maximum Vac	UL Listed Interrupting Rating – kA			Dimensions Inches (mm)							Approx. Ship Wt./Std. Pack
				240 Vac	480 Vac	600 Vac	H	W	D	A	B	C	E	
SE150 Current Limiting (UL File No. E-11592; CSA LR 40350) 1														
SED ²	15-150	2	480	18	18	—	6.31 (160)	4.12 (105)	3.38 (86)	2.41 (61)	2.47 (63)	.69 (18)	.72 (18)	5.65 lb/ 1
		3	600			14								
SEH ²		2	480	65	25	—								
		3	600			18								
SEL	15-150	2	480	100	65	—								
		3	600			25								
SEP		2	480	200	100	—								
		3	600			25								
SF-250 Current Limiting (UL File No. E-11592; CSA LR 40350) 1														
SFH ²	70-250	2	480	65	35	—	10.12 (257)	4.12 (105)	3.81 (97)	3.87 (98)	3.87 (98)	.69 (18)	1.19 (30)	9.15 lb/ 1
		3	600			22								
SFL	70-250	2	480	100	65	—								
		3	600			25								
SFP		2	480	200	100	—								
		3	600			25								
SG600 Current Limiting (UL File No. E-11592; CSA LR 40350) 3														
SGH1 ^{2,4}	60-150	3	600	65	35	25	10.09 (256) 5	5.50 (140)	3.81 (97)	4.45 (113)	3.30 (84)	.91 (23)	1.18 (30) 5	15.85 lb/ 1
SGD ²	125-400	2	240	65	—	—								
		3	600	—	—									
SGH4 ²		2	600	65	35	25								
		3	600											
SGH6 ²	250-600	2	600	65	35	25								
		3	600											
SGL1 ⁴	60-150	3	600	100	65	65								
SGP1 ⁴			3	600	200	100								
SGL4	125-400	2	600	100	65	65								
		3	600											
SGP4		2	600	200	100	65								
		3	600											
SGL6	250-600	2	600	100	65	65								
		3	600											
SGP6		2	600	200	100	65								
		3	600											
SK1200 (UL File No. E-11592; CSA LR 40350) 3														
SKH8	300-800	2	600	65	50	25	15.50 (394) 6	8.25 (210)	5.50 (140)	8.56 (217)	5.69 (145)	1.38 (35)	.62 (16) 6	47.6 lb/ 1
		3												
SKL8		2												
	3	600	100	65	42									
SKP8		2	600	200	100	65								
		3												
SKH12	600-1200	2	600	65	50	25								
		3												
SKL12		2					600	100	65	42				
	3	600	100	65	42									
SKP12		2	600	200	100	65								
		3												

¹ UL listed as HACR (heating, air conditioning and refrigeration) type.

² Not current-limiting circuit breaker.

³ Includes MicroVersaTrip Plus Trip Units and MicroVersaTrip PM Trip Units.

⁴ MicroVersaTrip Plus™ Trip Units and MicroVersaTrip PM™ Trip Units only.

⁵ Add 1.76 inches (45 mm) to each end with lugs and lug cover installed.

⁶ Add 4.00 inches (101 mm) to upper end for SKP (100 kAIC-480V) lug cover.

MOLDED CASE
CIRCUIT BREAKERS

3



Industrial Circuit Breakers

15-1200A Circuit Breakers

Electric Trip Spectra RMS Breakers

Quick Reference Guide

Ratings do not apply to molded case switches

IEC/JIS Ratings

Solid-State with Interchangeable Trip Unit (Rating Plug)

Circuit Breaker Type	Ampere Rating	No. Poles	IEC 947-2 Interruption Capacity – kA								Japanese Industry Standard Interruption Capacity kA			
			220-240 Vac		380-415 Vac		500 Vac		690 Vac		Vac			
			I _{cu}	I _{cs}	I _{cu}	I _{cs}	I _{cu}	I _{cs}	I _{cu}	I _{cs}	220-240	380-415	500	690
SE150 Current Limiting, 15-32A														
SED	15-32	2	18	9	10	5	—	—	—	—	18	10	—	—
		3	—	—	—	—	—	4	4	—	—	—	—	—
SEH	15-32	2	65	33	15	10	—	—	—	—	65	15	—	—
		3	—	—	—	—	—	6	6	—	—	—	—	—
SEL	15-32	2	100	50	20	15	—	—	—	—	100	20	—	—
		3	—	—	—	—	—	8	8	3	3	—	—	—
SEP	15-32	2	200	100	20	20	—	—	—	—	200	20	—	—
		3	—	—	—	—	—	10	10	5	5	—	—	—
SE150 Current Limiting, 40-160A														
SED	40-160	2	18	9	14	7	—	—	—	—	18	14	—	—
		3	—	—	—	—	—	14	7	—	—	—	—	—
SEH	40-160	2	65	33	35	17	—	—	—	—	65	25	—	—
		3	—	—	—	—	—	25	12	—	—	—	—	—
SEL	40-160	2	100	50	65	33	—	—	—	—	100	65	—	—
		3	—	—	—	—	—	40	20	5	5	—	—	—
SEP	40-160	2	200	100	100	50	—	—	—	—	200	100	—	—
		3	—	—	—	—	—	50	25	10	5	—	—	—
SF250 Current Limiting														
SFH	70-250	2	65	33	35	17	—	—	—	—	65	25	—	—
		3	—	—	—	—	—	25	12	—	—	—	—	—
SFL	70-250	2	100	50	65	33	—	—	—	—	100	65	—	—
		3	—	—	—	—	—	40	20	14	7	—	—	—
SFP	70-250	2	200	100	100	50	—	—	—	—	200	100	—	—
		3	—	—	—	—	—	65	33	18	9	—	—	—
SG600 Current Limiting														
SGH1 ¹	60-150	2	65	33	25	13	—	—	—	—	65	25	—	—
		3	—	—	—	—	—	18	9	—	—	—	—	—
SGH4	125-400	2	65	33	25	13	—	—	—	—	65	25	—	—
		3	—	—	—	—	—	18	9	—	—	—	—	—
SGH6	250-600	2	65	33	25	13	—	—	—	—	65	25	—	—
		3	—	—	—	—	—	18	9	—	—	—	—	—
SGL1 ¹	60-150	2	100	50	65	33	—	—	—	—	100	65	—	—
		3	—	—	—	—	—	35	18	14	7	—	—	—
SGP1 ¹	60-150	2	200	100	100	50	—	—	—	—	200	100	—	—
		3	—	—	—	—	—	50	25	18	9	—	—	—
SGL4	125-400	2	100	50	65	33	—	—	—	—	100	65	—	—
		3	—	—	—	—	—	35	18	14	7	—	—	—
SGP4	125-400	2	200	100	100	50	—	—	—	—	200	100	—	—
		3	—	—	—	—	—	50	25	18	9	—	—	—
SGL6	250-600	2	100	50	65	33	—	—	—	—	100	65	—	—
		3	—	—	—	—	—	35	18	14	7	—	—	—
SGP6	250-600	2	200	100	100	50	—	—	—	—	200	100	—	—
		3	—	—	—	—	—	50	25	18	9	—	—	—
SK1200														
SKH8	300-800	2	65	16	50	13	25	13	—	—	65	50	25	—
		3	—	—	—	—	—	—	—	—	—	—	—	—
SKL8	300-800	2	100	25	65	16	42	21	14	14	100	65	42	14
		3	—	—	—	—	—	—	—	—	—	—	—	—
SKP8	300-800	2	140	35	85	25	50	25	18	18	140	85	50	18
		3	—	—	—	—	—	—	—	—	—	—	—	—
SKH12	600-1250	2	65	16	50	13	25	13	—	—	65	50	25	—
		3	—	—	—	—	—	—	—	—	—	—	—	—
SKL12	600-1250	2	100	25	65	21	42	16	14	14	100	65	42	14
		3	—	—	—	—	—	—	—	—	—	—	—	—
SKP12	600-1250	2	140	35	70	25	50	25	18	18	140	85	50	18
		3	—	—	—	—	—	—	—	—	—	—	—	—

¹ MicroVersaTrip Plus™ trip system only.

Publications and Reference: See Section 21 for a list of additional product-related publications

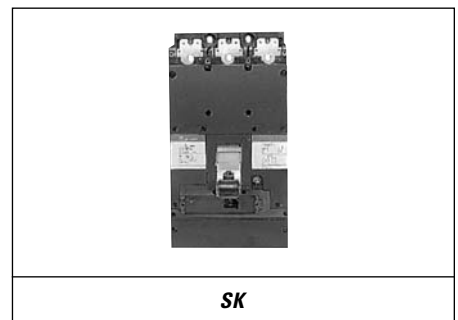
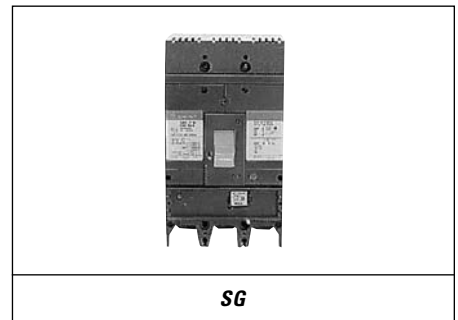
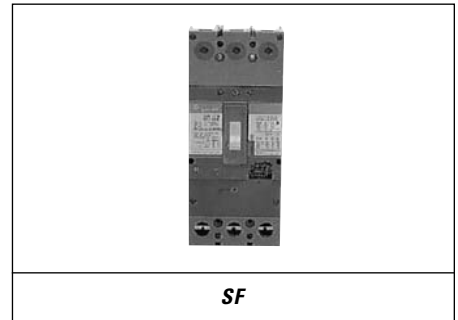
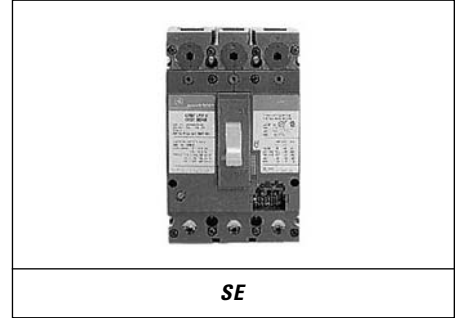

MOLDED CASE CIRCUIT BREAKERS

3

Industrial Circuit Breakers

10-1200A Circuit Breakers Thermal Magnetic Trip

Ratings do not apply to molded case switches. The interruption ratings and voltages shown in the table are maximum ratings. A circuit breaker of the type given in the left-hand column may be applied at the given circuit voltage in any electrical distribution system where the available fault current at the load terminals of the breaker does not exceed the value in the table. That circuit breaker type may also be applied at intermediate values of circuit voltage provided the available fault current at the load terminals of the breaker does not exceed the value in the table for the higher value of voltage.

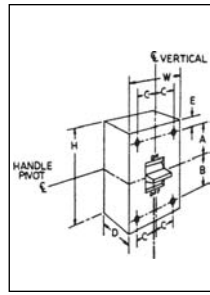

Quick Reference Guide

E150 (UL File E-11592; Fixed Thermal Magnetic Trip Unit; CSA LR 57114)

Circuit Breaker Type	Ampere Rating	No. Poles	Maximum Voltage Rating		UL Listed Interrupting Ratings— kA									Dimensions (In.)						Approx. Ship Wt./Std. Pack	
			ac	dc	Vac					Vdc				H	W	D	A	B	C		E
					120	120/240	240	277	480	600	125	250	500 ¹								
TEB ²	10-100 ³	1	120	125	10	—	—	—	—	—	5	—	—	6 5/16	1 3/8	3 3/8	2 41/64	2 15/64	—	23/32	26 lb/24
		2	240	250	—	—	10	—	—	—	—	5	—	—	2 3/4				—		24 lb/12
		3	—	—	—	—	—	—	—	—	—	—	—	4 1/8	—				11/16		28 lb/8
TED ²	10-100 ³ 15-100	1	277,347 ⁴	125	—	—	14	10	—	10	—	—	6 5/16	1 3/8	3 3/8	2 41/64	2 15/64	—	23/32	26 lb/24	
		2	480	250	—	—	18	—	18	—	—	10	—	—				2 3/4		—	24 lb/12
		3	600	500	—	—	—	—	—	—	—	10	10	4 1/8				—		11/16	28 lb/8
THED ²	15-30 15-100 15-100 110-150	1	277,347 ⁴	125	—	—	65	—	—	20 ⁵	—	—	6 5/16	1 3/8	3 3/8	2 41/64	2 15/64	—	23/32	26 lb/24	
		2	480	250	—	—	65	—	—	—	20 ⁵	—	—	4 1/8				—		24 lb/12	
		2	480	250	—	—	65	—	—	—	—	—	—	—				—		11/16	28 lb/8
		3	480,600	—	—	—	42	—	25	18	—	10	—	—				—		—	—
TEL ⁶	15-150	3	600	—	—	100	100	—	65	25	—	—	6 5/16	4 1/8	3 29/32	2 7/16	2 15/32	11/16	23/32	3 1/2 lb/1	

F225 (UL File E-11592; TFJ, Fixed Thermal Magnetic Trip Unit; TFK, THFK: Interchangeable Thermal Mag. Trip Unit; CSA LR 40350)

Circuit Breaker Type	Ampere Rating	No. Poles	Maximum Voltage Rating		UL Listed Interrupting Ratings— kA									Dimensions (In.)						Approx. Ship Wt./Std. Pack	
			ac	dc	Vac					Vdc				H	W	D	A	B	C		E
					120	120/240	240	277	480	600	125	250	500 ¹								
TFJ ²	70-225	2	480	250	—	—	25	—	22	—	10	—	10 1/8	4 1/8	3 13/16	3 7/8	3 7/8	11/16	1 3/16	10 lb/1	
	70-250	3	600	500	—	—	—	—	—	—	10	10	—	—	—	—	—	—	—	12 lb/1	
TFK ²	70-225	2	480	250	—	—	25	—	22	—	10	—	10 1/8	4 1/8	3 13/16	3 7/8	3 7/8	11/16	1 3/16	10 lb/1	
		3	600	—	—	—	—	—	—	—	—	—	—	—	—	—	—	—	—	12 lb/1	
THFK ²	70-225	2	480	250	—	—	65	—	25	—	20 ⁵	—	10 1/8	4 1/8	3 13/16	3 7/8	3 7/8	11/16	1 3/16	10 lb/1	
		3	600	—	—	—	—	—	—	—	—	—	—	—	—	—	—	—	—	12 lb/1	
TFL ⁶	70-225	3	600	—	—	100	100	—	65	25	—	—	10 1/8	4 1/8	3 13/16	3 7/8	3 7/8	11/16	1 3/16	—	

J600 (UL File E-11592; TJJ, Fixed Thermal Magnetic Trip Unit; TJK, THJK: Interchangeable Thermal Mag. Trip Unit; CSA LR 40350)

TJJ, TJK4	125-400	2	600	250	—	—	42	—	30	22	—	10	10 1/8	8 1/4	3 13/16	3 15/16	3 13/16	1 3/8	1 3/16	16 lb/1
		500		—								20								20 ⁸
TJK6	250-600	2	600	250	—	—	42	—	30	22	—	10	10 1/8	8 1/4	3 13/16	3 15/16	3 13/16	1 3/8	1 3/16	18 lb/1
		500		—								20								20
THJK4	125-400	2	600	250	—	—	65	—	35	25	—	40	10 1/8	8 1/4	3 13/16	3 15/16	3 13/16	1 3/8	1 3/16	16 lb/1
		—		—								—								—
THJK6	250-600	2	600	250	—	—	65	—	35	25	—	40	10 1/8	8 1/4	3 13/16	3 15/16	3 13/16	1 3/8	1 3/16	18 lb/1
		—		—								—								—

K1200 (UL File E-11592; Interchangeable Thermal Magnetic Trip Unit; CSA LR 40350)

TKM8	300-800	2	600	250	—	—	42	—	30	22	—	10	15 1/2	8 1/4	5 1/2	8 9/16	5 11/16	1 3/8	5/8	33 lb/1
		500		—								20								22
TKM12	600-1200	2	600	—	—	—	42	—	30	22	—	—	15 1/2	8 1/4	5 1/2	8 9/16	5 11/16	1 3/8	5/8	38 lb/1
		—		—								—								—
THKM8	300-800	2	600	250	—	—	65	—	35	25	—	40 ⁷	15 1/2	8 1/4	5 1/2	8 9/16	5 11/16	1 3/8	5/8	33 lb/1
		—		—								—								—
THKM12	600-1200	2	600	—	—	—	65	—	35	25	—	—	15 1/2	8 1/4	5 1/2	8 9/16	5 11/16	1 3/8	5/8	38 lb/1
		—		—								—								—

¹ UL listed with poles in series for 500 Vdc ungrounded battery applications.

² All UL listed as HACR type.

³ 10 amp not UL listed.

⁴ UL listed/CSA Certified for 10kA @ 347 Vac (TED) and 18kA @ 347V (THED). Also rated 10kA @ 480V but not UL listed.

⁵ UL listed at 10,000 amps.

⁶ Discontinued

⁷ Also 10,000 amps at 500 Volts dc. Not UL listed.

⁸ 500 Vdc on TJK only.



MOLDED CASE CIRCUIT BREAKERS

3

Molded Case Circuit Breakers

Quick Reference Guide

Ratings do not apply to molded case switches. The interruption ratings and voltages shown in the table are maximum ratings. A circuit breaker of the type given in the left-hand column may be applied at the given circuit voltage in any electrical distribution system where the available fault current at the load terminals of the breaker does not exceed the value in the table. That circuit breaker type may also be applied at intermediate values of circuit voltage provided the available fault current at the load terminals of the breaker does not exceed the value in the table for the higher value of voltage.

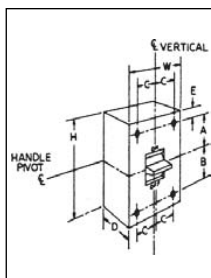

R Frame¹ (UL File E-11592; Interchangeable Solid-State MicroVersaTrip Plus Trip Unit; CSA LR 10263)

Circuit Breaker Type	Ampere Rating	No. Poles	Maximum Voltage Rating		UL Listed Interrupting Ratings—rms Symmetrical Amps (In Thousands)								Dimensions (In.)					Approx. Ship Wt./Std. Pack		
					Vac				Vdc				H	W	D	A	B		C	E
					120	120/240	240	277	480	600	125	250								
TRL...10, 16	400-1600	3	600	—	—	—	100	—	65	50	—	—	17 1/2	13 1/2	8 5/16	—	—	—	—	90/1
TRP...10, 16	400-1600	3	600	—	—	—	125	—	100	65	—	—	17 1/2	13 1/2	8 5/16	—	—	—	—	90/1
TRL...20	800-2000	3	600	—	—	—	100	—	65	50	—	—	20	13 1/2	8 5/16	—	—	—	—	96/1
TRP...20	800-2000	3	600	—	—	—	125	—	100	65	—	—	20	13 1/2	8 5/16	—	—	—	—	96/1

Tri-Break (UL File E-42263; Integrally Fused, Thermal Magnetic Trip Unit)

TB1 ^{2,3}	15-100	3	600	—	—	—	200	—	200	200	—	—	10 5/16	4 1/8	3 5/8	2 21/32	6 9/32	11/16	23/32	8 lb/1
TB4 ^{2,4}	125-400	3	600	—	—	—	200	—	200	200	—	—	16 1/8	8 1/4	4 1/2	3 15/16	9 13/16	1 3/8	1 3/16	31 lb/1
																				33 lb/1
TB6 ^{2,4}	300-600	3	600	—	—	—	200	—	200	200	—	—	21 7/8	8 1/4	5 7/8	8 9/16	12 1/16	1 3/8	5/8	53 lb/1
																				55 lb/1
TB8 ^{2,4}	600-800	3	600	—	—	—	200	—	200	100	—	—	21 7/8	8 1/4	5 7/8	8 9/16	12 1/16	1 3/8	5/8	53 lb/1
																				55 lb/1

Mag-Break (UL Files E-11592, E-66390; Magnetic Trip Unit)⁵

TEC	3-150	2	480	250	—	—	10	—	10	10	—	10	6 5/16	4 1/8	3 3/8	2 41/64	2 15/64	11/16	23/32	21 lb/6
		3	600	—	—	—	—	—	—	—	—	—	—	—	—	—	—	—	—	—
TEML ⁶	3-150	3	600	250	—	—	100	—	65	25	—	—	6 5/16	4 1/8	3 7/8	2 41/64	2 15/64	11/16	23/32	3 1/2 lb/1
TEC & TECL ⁷	3-150	3	600	—	—	—	100	—	100	100	—	—	8 3/16	4 1/8	3 3/8	2 41/64	2 15/64	11/16	23/32	1.2 lb/1 TECL Only
TFC	225	3	600	—	—	—	25	—	22	18	—	—	10 1/8	4 1/8	3 13/16	3 7/8	3 7/8	11/16	1 3/16	10 lb/1 12 lb/1
TBC4	225-400	3	600	—	—	—	100	—	100	100	—	—	16 1/8	8 1/4	4 1/2	3 15/16	9 13/16	1 3/8	1 3/16	31 lb/1
																				33 lb/1
TJC	400-600	3	600	—	—	—	42	—	30	22	—	—	10 1/8	8 1/4	3 13/16	3 13/16	3 13/16	1 3/8	1 3/16	16 lb/1
																				17 1/2/1
TBC6	600	3	600	—	—	—	100	—	100	100	—	—	21 7/8	8 1/4	5 7/8	8 9/16	12 1/16	1 3/8	5/8	53 lb/1
																				55 lb/1
TKC	800-1200	3	600	—	—	—	42	—	30	22	—	—	15 1/2	8 1/4	5 1/2	8 9/16	5 11/16	1 3/8	5/8	38 lb/1
																				41 1/2/1
TBC8	800	3	600	—	—	—	100	—	100	100	—	—	21 7/8	8 1/4	5 7/8	8 9/16	12 1/16	1 3/8	5/8	53 lb/1
																				55 lb/1

MicroVersaTrip (UL File E-11592; Solid-State Trip Units)

TJ4V ^{8,9}	150-600	3	600	—	—	42	42	—	30	22	—	—	10 1/8	8 1/4	3 13/16	3 15/16	3 13/16	1 3/8	1 3/16	—
THJ4V ^{8,9}						65	65	—	35	25										
TJL4V ⁸						100	100	—	65	30										
TK4V ⁸	800-1200	3	600	—	—	42	42	—	30	22	—	—	15 1/2	8 1/4	5 1/2	8 9/16	5 11/16	1 3/8	5/8	—
TKL4V ⁸	800-1200	3	600	—	—	100	100	—	65	42	—	—	15 1/2	8 1/4	5 1/2	8 9/16	5 11/16	1 3/8	5/8	—
TJH1S-6S	60-600	3	600	—	—	65	65	—	35	25	—	—	16 1/8	8 1/4	3 13/16	3 15/16	9 13/16	1 3/8	1 3/16	—
TJL1S-6S	60-600	3	600	—	—	100	100	—	65	30	—	—	16 1/8	8 1/4	3 13/16	3 15/16	9 13/16	1 3/8	1 3/16	—
TKH8S, 12S	300-1200	3	600	—	—	65	65	—	50	25	—	—	21 7/8	8 1/4	5 1/2	8 9/16	12 11/16	1 3/8	5/8	—
TKL8S, 12S	300-1200	3	600	—	—	100	100	—	65	42	—	—	21 7/8	8 1/4	5 1/2	8 9/16	12 11/16	1 3/8	5/8	—

¹ Rotary handle (not toggle handle).

² UL listed with internally mounted accessories at 100,000 amps IC. Contact GE Sales Office for availability of 200 kAIC ratings with internal accessories.

³ CSA LR 57114.

⁴ CSA LR 40350.

⁵ Per UL 489, interrupting capacities are not shown on product label

⁶ Discontinued.

⁷ Ratings shown for TEC in combination with TECL.

⁸ With Power+ 4 trip unit.

⁹ Suitable for single-phase, use outer two poles.

Publications and Reference: See Section 31 for a list of additional product-related publications



Industrial Circuit Breakers

15-150A Circuit Breakers

Electronic Trip

Spectra RMS

SE150 Line Circuit Breakers

Features

- Interchangeable trip using rating plugs
- True digital rms sensing
- Universal internal accessories UL listed for field installation
- Adjustable instantaneous with short-time tracking function
- CE marked

SE150 Line, Suitable for Reverse Feed, UL File E-11592, CSA LR 40350, UL listed HACR

GO-135S

SEL, SEP UL Current Limiting

2-Pole, UL/CSA: 150A, 480 Vac Max., IEC 947-2: 160A, 415 Vac Max.

Rating Plug					Frame					Terminal Lugs for Front Connection (Cu/Al)		
Adj. Inst. Trip Range Amps					UL 489 IC @480 Vac			UL 489 IC @480 Vac				
Ampere Rating	Low	High	Product Number	List Price	Current Sensor	18kA		25kA		Product Number	List Price	Wire Range
						Product Number	List Price	Product Number	List Price			
15	43	182	SRPE30A15	\$106.00	30	SEDA24AT0030	\$214.00	SEHA24AT0030	\$530.00	TCAL18	\$3.00	12-3/0 Cu 12-3/0 Al
20	58	254	SRPE30A20	\$106.00								
25	73	332	SRPE30A25	\$106.00								
30	87	415	SRPE30A30	\$106.00								
40	118	501	SRPE60A40	\$106.00								
50	148	637	SRPE60A50	\$106.00								
60	178	777	SRPE60A60	\$106.00								
70	206	863	SRPE100A70	\$106.00								
80	236	999	SRPE100A80	\$106.00								
90	267	1138	SRPE100A90	\$106.00								
100	297	1280	SRPE100A100	\$106.00								
110	328	1426	SRPE150A110	\$106.00								
125	374	1640	SRPE150A125	\$106.00								
150	450	1991	SRPE150A150	\$106.00								
					60	SEDA24AT0060	\$214.00	SEHA24AT0060	\$530.00			
					100	SEDA24AT0100	\$312.00	SEHA24AT0100	\$634.00			
					150	SEDA24AT0150	\$837.00	SEHA24AT0150	\$1427.00			

SE150 Line, Suitable for Reverse Feed, UL File E-11592, CSA LR 40350, UL listed HACR

GO-135S

2-Pole, UL/CSA: 150A, 480 Vac Max., IEC 947-2: 160A, 415 Vac Max.

Rating Plug					Frame					Terminal Lugs for Front Connection (Cu/Al)		
Adj. Inst. Trip Range Amps					UL 489 IC @480 Vac			UL 489 IC @480 Vac				
Ampere Rating	Low	High	Product Number	List Price	Current Sensor	65kA		100kA		Product Number	List Price	Wire Range
						Product Number	List Price	Product Number	List Price			
15	43	182	SRPE30A15	\$106.00	30	SELA24AT0030	\$549.00	SEPA24AT0030	\$895.00	TCAL18	\$3.00	12-3/0 Cu 12-3/0 Al
20	58	254	SRPE30A20	\$106.00								
25	73	332	SRPE30A25	\$106.00								
30	87	415	SRPE30A30	\$106.00								
40	118	501	SRPE60A40	\$106.00								
50	148	637	SRPE60A50	\$106.00								
60	178	777	SRPE60A60	\$106.00								
70	206	863	SRPE100A70	\$106.00								
80	236	999	SRPE100A80	\$106.00								
90	267	1138	SRPE100A90	\$106.00								
100	297	1280	SRPE100A100	\$106.00								
110	328	1426	SRPE150A110	\$106.00								
125	374	1640	SRPE150A125	\$106.00								
150	450	1991	SRPE150A150	\$106.00								
					100	SELA24AT0100	\$744.00	SEPA24AT0100	\$1179.00			
					150	SELA24AT0150	\$1808.00	SEPA24AT0150	\$2777.00			

MOLDED CASE CIRCUIT BREAKERS

3



Industrial Circuit Breakers

15-150A Circuit Breakers

Electronic Trip

Spectra RMS

SE150 Line Circuit Breakers

SE150 Line, Suitable for Reverse Feed, UL File E-11592, CSA LR 40350, UL listed HACR

GO-135S

3-Pole, UL/CSA: 150A, 600 Vac Max., IEC 947-2: 160A, 690 Vac Max.

Rating Plug					Frame					Terminal Lugs for Front Connection (Cu/Al)		
Adj. Inst. Trip Range Amps					UL 489 IC @480 Vac							
Ampere Rating	Low	High	Product Number	List Price	Current Sensor	18kA		25kA		Product Number	List Price	Wire Range
						Product Number	List Price	Product Number	List Price			
15	43	182	SRPE30A15	\$106.00	30	SEDA36AT0030	\$382.00	SEHA36AT0030	\$632.00	TCAL18	\$3.00	12-3/0 Cu 12-3/0 Al
20	58	254	SRPE30A20	\$106.00								
25	73	332	SRPE30A25	\$106.00								
30	87	415	SRPE30A30	\$106.00								
40	118	501	SRPE60A40	\$106.00								
50	148	637	SRPE60A50	\$106.00	60	SEDA36AT0060	\$382.00	SEHA36AT0060	\$632.00			
60	178	777	SRPE60A60	\$106.00								
70	206	863	SRPE100A70	\$106.00								
80	236	999	SRPE100A80	\$106.00	100	SEDA36AT0100	\$492.00	SEHA36AT0100	\$734.00			
90	267	1138	SRPE100A90	\$106.00								
100	297	1280	SRPE100A100	\$106.00								
110	328	1426	SRPE150A110	\$106.00								
125	374	1640	SRPE150A125	\$106.00	150	SEDA36AT0150	\$1253.00	SEHA36AT0150	\$1815.00			
150	450	1991	SRPE150A150	\$106.00								

SE150 Line, Suitable for Reverse Feed, UL File E-11592, CSA LR 40350, UL listed HACR

GO-135S

3-Pole, UL/CSA: 150A, 600 Vac Max., IEC 947-2: 160A, 690 Vac Max.

Rating Plug					Frame					Terminal Lugs for Front Connection (Cu/Al)		
Adj. Inst. Trip Range Amps					UL 489 IC @480 Vac							
Ampere Rating	Low	High	Product Number	List Price	Current Sensor	65kA		100kA		Product Number	List Price	Wire Range
						Product Number	List Price	Product Number	List Price			
15	43	182	SRPE30A15	\$106.00	30	SELA36AT0030	\$753.00	SEPA36AT0030	\$1189.00	TCAL18	\$3.00	12-3/0 Cu 12-3/0 Al
20	58	254	SRPE30A20	\$106.00								
25	73	332	SRPE30A25	\$106.00								
30	87	415	SRPE30A30	\$106.00								
40	118	501	SRPE60A40	\$106.00								
50	148	637	SRPE60A50	\$106.00	60	SELA36AT0060	\$753.00	SEPA36AT0060	\$1189.00			
60	178	777	SRPE60A60	\$106.00								
70	206	863	SRPE100A70	\$106.00								
80	236	999	SRPE100A80	\$106.00	100	SELA36AT0100	\$895.00	SEPA36AT0100	\$1482.00			
90	267	1138	SRPE100A90	\$106.00								
100	297	1280	SRPE100A100	\$106.00								
110	328	1426	SRPE150A110	\$106.00								
125	374	1640	SRPE150A125	\$106.00	150	SELA36AT0150	\$2165.00	SEPA36AT0150	\$3477.00			
150	450	1991	SRPE150A150	\$106.00								

www.DataSheet4U.com

Publications and Reference: See Section 21 for a list of additional product-related publications



www.DataSheet4U.com

MOLDED CASE CIRCUIT BREAKERS 3

Industrial Circuit Breakers

15-150A Circuit Breakers

Thermal-Magnetic Trip

E150 Line Circuit Breakers

Types TEB, TED, THED

Noninterchangeable Trip

Note: All UL listed as HACR type except 10 ampere

60°C/75°F Conductor 10-150 Amperes

Rating Through 100 Amperes 120-600 Vac

75°C above 100 Amperes 125, 250 Vdc



Single Pole — Includes Cu/Al load lugs only. If line lugs are required, add suffix "WL" to Product Number.

GO-135B

Ampere Rating	Type TEB		Type TED		Type THED					
	120 Vac 125 Vdc		277 Vac 125 Vdc		347 Vac ¹		277 Vac		347 Vac ¹	
	Product Number	List Price	Product Number	List Price	Product Number	List Price	Product Number	List Price	Product Number	List Price
10	TEB111010 ²	\$78.50	TED113010 ²	\$82.50						
15	TEB111015 ³	\$78.50	TED113015 ³	\$82.50	TED114015 ³	\$152.00	THED113015	\$229.00	THED114015 ³	\$416.00
20	TEB111020 ³	\$78.50	TED113020 ³	\$82.50	TED114020 ³	\$152.00	THED113020	\$229.00	THED114020 ³	\$416.00
25	TEB111025	\$78.50	TED113025	\$82.50	TED114025	\$152.00	THED113025	\$229.00	THED114025	\$416.00
30	TEB111030	\$78.50	TED113030	\$82.50	TED114030	\$152.00	THED113030	\$229.00	THED114030	\$416.00
35	TEB111035	\$78.50	TED113035	\$82.50	—	—	—	—	—	—
40	TEB111040	\$78.50	TED113040	\$82.50	—	—	—	—	—	—
45	TEB111045	\$78.50	TED113045	\$82.50	—	—	—	—	—	—
50	TEB111050	\$78.50	TED113050	\$82.50	—	—	—	—	—	—
60	TEB111060	\$78.50	TED113060	\$82.50	—	—	—	—	—	—
70	TEB111070	\$134.00	TED113070	\$159.00	—	—	—	—	—	—
80	TEB111080	\$134.00	TED113080	\$159.00	—	—	—	—	—	—
90	TEB111090	\$134.00	TED113090	\$159.00	—	—	—	—	—	—
100	TEB111100	\$134.00	TED113100	\$159.00	—	—	—	—	—	—

Two Pole — Includes Cu/Al load lugs. For optional lugs, see page 3-101 and 3-102.

GO-135B

Ampere Rating	Type TEB		Type TED		Type THED, Hi-Break ⁴	
	240 Vac, 250 Vdc		480 Vac, 250 Vdc		480 Vac, 250 Vdc	
	Product Number	List Price	Product Number	List Price	Product Number	List Price
10	TEB122010WL ²	\$159.00	TED124010WL ²	\$290.00	—	—
15	TEB122015WL	\$159.00	TED124015WL	\$290.00	THED124015WL	\$560.00
20	TEB122020WL	\$159.00	TED124020WL	\$290.00	THED124020WL	\$560.00
25	TEB122025WL	\$159.00	TED124025WL	\$290.00	THED124025WL	\$560.00
30	TEB122030WL	\$159.00	TED124030WL	\$290.00	THED124030WL	\$560.00
35	TEB122035WL	\$159.00	TED124035WL	\$290.00	THED124035WL	\$560.00
40	TEB122040WL	\$159.00	TED124040WL	\$290.00	THED124040WL	\$560.00
45	TEB122045WL	\$159.00	TED124045WL	\$290.00	THED124045WL	\$560.00
50	TEB122050WL	\$159.00	TED124050WL	\$290.00	THED124050WL	\$560.00
60	TEB122060WL	\$159.00	TED124060WL	\$290.00	THED124060WL	\$560.00
70	TEB122070WL	\$261.00	TED124070WL	\$377.00	THED124070WL	\$653.00
80	TEB122080WL	\$261.00	TED124080WL	\$377.00	THED124080WL	\$653.00
90	TEB122090WL	\$261.00	TED124090WL	\$377.00	THED124090WL	\$653.00
100	TEB122100WL	\$261.00	TED124100WL	\$377.00	THED124100WL	\$653.00
110	—	—	TED124110WL	\$1000.00	—	—
125	—	—	TED124125WL	\$1000.00	—	—
150	—	—	TED124150WL	\$1000.00	—	—

¹Suitable for 10 kAIC at 480 Vac, but not labeled or UL listed.

²Not UL listed

³Single-pole, 15-and 20-ampere breakers are also UL listed as switching duty breakers, suitable for switching 120 Vac (TEB), 277, 347 Vac (TED, THED) fluorescent lighting loads.

⁴Two-pole breaker is furnished in three-pole case.

www.DataSheet4U.com



MOLDED CASE CIRCUIT BREAKERS 3

Industrial Circuit Breakers

15-150A Circuit Breakers

Thermal-Magnetic Trip

E150 Line Circuit Breakers

Types TEB, TED, THED

Note: All UL listed as HACR type except 10 ampere

60°C/75°F Conductor 10-150 Amperes

Rating Through 100 Amperes 120-600 Vac

75°C above 100 Amperes 125, 250 Vdc

Three Pole — Includes Cu/Al load lugs. For optional lugs, see page 3-101 and 3-102.

GO-135B

Ampere Rating	Type TEB		Type TED				Type THED, Hi-Break		
	240 Vac		480 Vac		600 Vac		480 Vac	600 Vac	
	Product Number	List Price	Product Number	List Price	Product Number	List Price	Product Number	Product Number	List Price
10	TEB132010WL ¹	\$240.00	TED134010WL ¹	\$377.00	TED136010WL ¹	\$439.00	—	—	—
15	TEB132015WL	\$240.00	TED134015WL	\$377.00	TED136015WL	\$439.00	THED134015WL	THED136015WL	\$655.00
20	TEB132020WL	\$240.00	TED134020WL	\$377.00	TED136020WL	\$439.00	—	THED136020WL	\$655.00
25	TEB132025WL	\$240.00	TED134025WL	\$377.00	TED136025WL	\$439.00	—	THED136025WL	\$655.00
30	TEB132030WL	\$240.00	TED134030WL	\$377.00	TED136030WL	\$439.00	THED134030WL	THED136030WL	\$655.00
35	TEB132035WL	\$240.00	TED134035WL	\$377.00	TED136035WL	\$439.00	—	THED136035WL	\$655.00
40	TEB132040WL	\$240.00	TED134040WL	\$377.00	TED136040WL	\$439.00	—	THED136040WL	\$655.00
45	TEB132045WL	\$240.00	TED134045WL	\$377.00	TED136045WL	\$439.00	THED134045WL	THED136045WL	\$655.00
50	TEB132050WL	\$240.00	TED134050WL	\$377.00	TED136050WL	\$439.00	—	THED136050WL	\$655.00
60	TEB132060WL	\$240.00	TED134060WL	\$377.00	TED136060WL	\$439.00	—	—	—
70	TEB132070WL	\$339.00	TED134070WL	\$445.00	TED136070WL	\$534.00	THED134070WL	THED136070WL	\$742.00
80	TEB132080WL	\$339.00	TED134080WL	\$445.00	TED136080WL	\$534.00	—	—	—
90	TEB132090WL	\$339.00	TED134090WL	\$445.00	TED136090WL	\$534.00	THED134090WL	THED136090WL	\$742.00
100	TEB132100WL	\$339.00	TED134100WL	\$445.00	TED136100WL	\$534.00	THED134100WL	THED136100WL	\$742.00
110	—	—	TED134110WL	\$1198.00	TED136110WL	\$1198.00	THED134110WL	THED136110WL	\$1683.00
125	—	—	TED134125WL	\$1198.00	TED136125WL	\$1198.00	THED134125WL	THED136125WL	\$1683.00
150	—	—	TED134150WL	\$1198.00	TED136150WL	\$1198.00	THED134150WL	THED136150WL	\$1683.00
100NA	—	—	TED134Y100 ²	\$377.00	TED136Y100 ²	\$445.00	—	—	—
150NA	—	—	TED134Y150 ²	\$967.00	TED136Y150 ²	\$967.00	—	—	—

¹Not UL listed.

²Includes factory-installed dummy trip.

Accessories: See pages 3-85 to 3-104.

www.DataSheet4U.com

Publications and Reference: See Section 21 for a list of additional product-related publications



www.DataSheet4U.com

Industrial Circuit Breakers

70-250A Circuit Breakers

Electronic Trip

Spectra RMS

SF250 Line Circuit Breakers

SF250 Line, Suitable for Reverse Feed, UL File E-11592, CSA LR 40350, UL listed HACR

GO-135S

SFH UL Current Limiting

2-Pole, UL/CSA: 250A, 480 Vac Max., IEC 947-2: 250A, 415 Vac Max.

Rating Plug					Frame			Terminal Lugs for Front Connection (Cu/Al)		
Ampere Rating	Adjustable Instantaneous Trip Ampere Range		Product Number	List Price	UL 489 IC @480 Vac			Product Number	List Price	Wire Range
	Low	High			Current Sensor	35kA				
					Product Number	List Price				
70	205	700	SRPF250A70	\$106.00	250	SFHA24AT0250	\$1134.00	TCAL29	\$8.00	8-350 Cu 8-350 Al
90	265	900	SRPF250A90	\$106.00						
100	295	1000	SRPF250A100	\$106.00						
110	325	1100	SRPF250A110	\$106.00						
125	370	1250	SRPF250A125	\$106.00						
150	440	1500	SRPF250A150	\$106.00						
175	515	1750	SRPF250A175	\$106.00						
200	590	2000	SRPF250A200	\$106.00						
225	665	2250	SRPF250A225	\$106.00						
250	736	2500	SRPF250A250	\$106.00						

SF250 Line, Suitable for Reverse Feed, UL File E-11592, CSA LR 40350, UL listed HACR

GO-135S

SFL, SFP UL Current Limiting

2-Pole, UL/CSA: 250A, 480 Vac Max., IEC 947-2: 250A, 415 Vac Max.

Rating Plug					Frame					Terminal Lugs for Front Connection (Cu/Al)		
Ampere Rating	Adjustable Instantaneous Trip Ampere Range		Product Number	List Price	UL 489 IC @480 Vac			UL 489 IC @480 Vac		Product Number	List Price	Wire Range
	Low	High			Current Sensor	65kA		100kA				
					Product Number	List Price	Product Number	List Price				
70	205	700	SRPF250A70	\$106.00	250	SFLA24AT0250	\$2175.00	SFPA24AT0250	\$2790.00	TCAL29	\$8.00	8-350 Cu 8-350 Al
90	265	900	SRPF250A90	\$106.00								
100	295	1000	SRPF250A100	\$106.00								
110	325	1100	SRPF250A110	\$106.00								
125	370	1250	SRPF250A125	\$106.00								
150	440	1500	SRPF250A150	\$106.00								
175	515	1750	SRPF250A175	\$106.00								
200	590	2000	SRPF250A200	\$106.00								
225	665	2250	SRPF250A225	\$106.00								
250	736	2500	SRPF250A250	\$106.00								

SF250 Line, Suitable for Reverse Feed, UL File E-11592, CSA LR 40350, UL listed HACR

GO-135S

SFH UL Current Limiting

3-Pole, UL/CSA: 250A, 600 Vac Max., IEC 947-2: 250A, 690 Vac Max.

Rating Plug					Frame			Terminal Lugs for Front Connection (Cu/Al)		
Ampere Rating	Adjustable Instantaneous Trip Ampere Range		Product Number	List Price	UL 489 IC @480 Vac			Product Number	List Price	Wire Range
	Low	High			Current Sensor	35kA				
					Product Number	List Price				
70	205	700	SRPF250A70	\$106.00	250	SFHA36AT0250	\$1441.00	TCAL29	\$8.00	8-350 Cu 8-350 Al
90	265	900	SRPF250A90	\$106.00						
100	295	1000	SRPF250A100	\$106.00						
110	325	1100	SRPF250A110	\$106.00						
125	370	1250	SRPF250A125	\$106.00						
150	440	1500	SRPF250A150	\$106.00						
175	515	1750	SRPF250A175	\$106.00						
200	590	2000	SRPF250A200	\$106.00						
225	665	2250	SRPF250A225	\$106.00						
250	736	2500	SRPF250A250	\$106.00						



Industrial Circuit Breakers

70-250A Circuit Breakers

Electronic Trip

Spectra RMS

SF250 Line Circuit Breakers

SF250 Line, Suitable for Reverse Feed, UL File E-11592, CSA LR 40350, UL listed HACR

GO-135S

SFL, SFP UL Current Limiting

3-Pole, UL/CSA: 250A, 600 Vac Max., IEC 947-2: 250A, 690 Vac Max.

Rating Plug					Frame					Terminal Lugs for Front Connection (Cu/Al)		
Ampere Rating	Adjustable Instantaneous Trip Ampere Range		Product Number	List Price	UL 489 IC @480 Vac			UL 489 IC @480 Vac		Product Number	List Price	Wire Range
	Low	High			65kA		100kA					
					Current Sensor	Product Number	List Price	Product Number	List Price			
70	205	700	SRPF250A70	\$106.00								
90	265	900	SRPF250A90	\$106.00								
100	295	1000	SRPF250A100	\$106.00								
110	325	1100	SRPF250A110	\$106.00								
125	370	1250	SRPF250A125	\$106.00	250	SFLA36AT0250	\$2631.00	SFPA36AT0250	\$3490.00	TCAL29	\$8.00	8-350 Cu
150	440	1500	SRPF250A150	\$106.00								8-350 Al
175	515	1750	SRPF250A175	\$106.00								
200	590	2000	SRPF250A200	\$106.00								
225	665	2250	SRPF250A225	\$106.00								
250	736	2500	SRPF250A250	\$106.00								

www.DataSheet4U.com

Publications and Reference: See Section 21 for a list of additional product-related publications



www.DataSheet4U.com

Industrial Circuit Breakers

70-250A Circuit Breakers

Thermal-Magnetic Trip

F225 Line Circuit Breakers

Types TFJ, TFK, THFK

F225 Line Circuit Breakers

—70-250 Amperes—TFJ Noninterchangeable Trip, suitable for reverse feed

—70-225A TFK, THFK Interchangeable Trip, not suitable for reverse feed

—480 or 600 Vac

—250 Vdc

Note: All TFJ, TFK and THFK breakers are UL listed as HACR

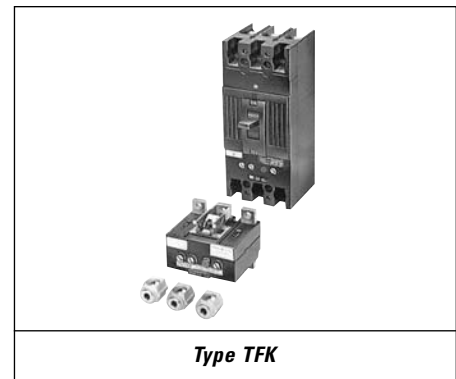

Type TFJ — Noninterchangeable Trip

GO-135B

Ampere Rating	Adjustable Instantaneous Trip Ampere Range		Complete Breaker 480 Vac Max		Complete Breaker 600 Vac Max		Copper/Aluminum Lugs	Wire Size
	Low	High	Product Number	List Price	Product Number	List Price		
Two-Pole			Three-Pole					
70	600	900	TFJ224070WL	\$1122.00	TFJ236070WL	\$1407.00	TCAL24	4-300 Cu/Al
80	700	1000	TFJ224080WL	\$1122.00	TFJ236080WL	\$1407.00		
90	600	900	TFJ224090WL	\$1122.00	TFJ236090WL	\$1407.00		
100	600	1250	TFJ224100WL	\$1122.00	TFJ236100WL	\$1407.00		
110	660	1250	TFJ224110WL	\$1122.00	TFJ236110WL	\$1407.00		
125	600	1250	TFJ224125WL	\$1122.00	TFJ236125WL	\$1407.00		
150	700	1500	TFJ224150WL	\$1122.00	TFJ236150WL	\$1407.00		
175	800	1750	TFJ224175WL	\$1122.00	TFJ236175WL	\$1407.00		
200	900	2000	TFJ224200WL	\$1122.00	TFJ236200WL	\$1407.00		
225	1000	2250	TFJ224225WL	\$1122.00	TFJ236225WL	\$1407.00		
250	1000	2250	—	—	TFJ236250WL	\$2075.00		

Types TFK, THFK — Interchangeable Trip

GO-135B

Ampere Rating	Adjustable Instantaneous Trip Ampere Range		Complete Circuit Breaker Includes Line and Load Lugs				Trip Unit Only		Frame Only		Terminal Lugs for Front Connection (Copper/Aluminum) ²					
			Standard		High-Break		Use with Standard and Hi-Break Frames	List Price	Product Number	List Price	Product Number (Order 1 line and 1 load per pole)	List Price	Wire Size			
	Low	High	Product Number	List Price	Product Number	List Price										
Two-Pole, 480 Vac Max., 250 Vdc Max.																
70	600	900	TFK224070WL	\$1122.00	THFK224070WL	\$2315.00	TFK226T070	\$337.00	Standard Frame	TCAL24	\$8.00	4-300 Cu/Al				
80	700	1000	TFK224080WL	\$1122.00	THFK224080WL	\$2315.00	TFK226T080	\$337.00								
90	600	900	TFK224090WL	\$1122.00	THFK224090WL	\$2315.00	TFK226T090	\$337.00								
100	600	1250	TFK224100WL	\$1122.00	THFK224100WL	\$2315.00	TFK226T100	\$337.00								
110	660	1250	TFK224110WL	\$1122.00	THFK224110WL	\$2315.00	TFK226T110	\$337.00								
125	600	1250	TFK224125WL	\$1122.00	THFK224125WL	\$2315.00	TFK226T125	\$337.00								
150	700	1500	TFK224150WL	\$1122.00	THFK224150WL	\$2315.00	TFK226T150	\$337.00								
175	800	1750	TFK224175WL	\$1122.00	THFK224175WL	\$2315.00	TFK226T175	\$337.00								
200	900	2000	TFK224200WL	\$1122.00	THFK224200WL	\$2315.00	TFK226T200	\$337.00								
225	1000	2250	TFK224225WL	\$1122.00	THFK224225WL	\$2315.00	TFK226T225	\$337.00								
Three-Pole, 600 Vac Max., 250 Vdc Max.																
70	600	900	TFK236070WL	\$1407.00	THFK236070WL	\$2787.00	TFK236T070	\$445.00					Standard Frame	TCAL24	\$8.00	4-300 Cu/Al
80	700	1000	TFK236080WL	\$1407.00	THFK236080WL	\$2787.00	TFK236T080	\$445.00								
90	600	900	TFK236090WL	\$1407.00	THFK236090WL	\$2787.00	TFK236T090	\$445.00								
100	600	1250	TFK236100WL	\$1407.00	THFK236100WL	\$2787.00	TFK236T100	\$445.00								
110	660	1250	TFK236110WL	\$1407.00	THFK236110WL	\$2787.00	TFK236T110	\$445.00								
125	600	1250	TFK236125WL	\$1407.00	THFK236125WL	\$2787.00	TFK236T125	\$445.00								
150	700	1500	TFK236150WL	\$1407.00	THFK236150WL	\$2787.00	TFK236T150	\$445.00								
175	800	1750	TFK236175WL	\$1407.00	THFK236175WL	\$2787.00	TFK236T175	\$445.00								
200	900	2000	TFK236200WL	\$1407.00	THFK236200WL	\$2787.00	TFK236T200	\$445.00								
225	1000	2250	TFK236225WL	\$1407.00	THFK236225WL	\$2787.00	TFK236T225	\$445.00								
225	600	1400	—	—	—	—	TFK236TM1225 ³	\$555.00								
Mag Only	1000	2250	—	—	—	—	TFK236TM2225 ³	\$555.00								

¹TC024 load end. Wire range #4-300 copper only.

²For optional lug see page 3-101.

Accessories: See pages 3-85 to 3-104.

MOLDED CASE CIRCUIT BREAKERS

3



Industrial Circuit Breakers

125-400A Circuit Breakers

Thermal-Magnetic Trip

Q Line Circuit Breakers

Types TJD

Three-Pole TJD		GO-135F
TJD Lug-lug 240 Vac ¹		22 kAIC
Ampere Rating	Product Number	List Price
250	TJD432250WL ²	\$1802.00
300	TJD432300WL ²	\$1802.00
350	TJD432350WL ²	\$1802.00
400	TJD432400WL ²	\$1802.00
400 Molded Case Switch	TJD432Y400 ²	\$1509.00

¹Includes line and load lugs. For optional configurations, see page 3-21.

²TJD uses same accessories as J600 line. TJD not listed HACR.

See page 3-4 for size and ratings.



www.DataSheet4U.com

Publications and Reference: See Section 21 for a list of additional product-related publications



www.DataSheet4U.com

Industrial Circuit Breakers

125-600A Circuit Breakers

Electronic Trip

Spectra RMS

SG600

Digital, Solid-State Spectra RMS Breakers

SG600 Line, Suitable for Reverse Feed, UL File E-11592, CSA LR 40350

GO-135S

SGL, SGP UL Current Limiting

UL/CSA: 400A, 600 Vac Max., IEC 947-2: 400A, 690 Vac Max.

Rating Plug					Frame					Terminal Lugs for Front Connection (Cu/Al)				
Ampere Rating	Adjustable Instantaneous Trip Ampere Range		Product Number	List Price	Current Sensor	Poles	UL 489 IC @480 Vac		UL 489 IC @480 Vac		Product Number	List Price	Wire Range	
	Low	High					65kA (240 Vac)		35kA					
125	380	1275	SRPG400A125	\$106.00	400	2	SGDA22AT0400 ¹	\$1540.00	SGHA26AT0400	\$1959.00	2-pole lug kit	TCLK265 ²	\$28.00	(2) 2/0-500 Cu or (1) 8-600 Cu
150	455	1530	SRPG400A150	\$106.00										
175	530	1785	SRPG400A175	\$106.00										
200	605	2040	SRPG400A200	\$106.00										
225	680	2295	SRPG400A225	\$106.00		3	SGDA32AT0400 ¹	\$1860.00	SGHA36AT0400	\$2383.00	3-pole lug kit	TCLK365 ²	\$42.00	(2) 2/0-500 Al or (1) 6-600 Al
250	755	2550	SRPG400A250	\$106.00										
300	905	3060	SRPG400A300	\$106.00										
350	1060	3570	SRPG400A350	\$106.00										
400	1210	4080	SRPG400A400	\$106.00										

SG600 Line, Suitable for Reverse Feed, UL File E-11592, CSA LR 40350

GO-135S

SGL, SGP UL Current Limiting

UL/CSA: 400A, 600 Vac Max., IEC 947-2: 400A, 690 Vac Max.

Rating Plug					Frame					Terminal Lugs for Front Connection (Cu/Al)				
Ampere Rating	Adjustable Instantaneous Trip Ampere Range		Product Number	List Price	Current Sensor	Poles	UL 489 IC @480 Vac		UL 489 IC @480 Vac		Product Number	List Price	Wire Range	
	Low	High					65kA		100kA					
125	380	1275	SRPG400A125	\$106.00	400	2	SGLA26AT0400	\$2926.00	SGPA26AT0400	\$3856.00	2-pole lug kit	TCLK265 ²	\$28.00	(2) 2/0-500 Cu or (1) 8-600 Cu
150	455	1530	SRPG400A150	\$106.00										
175	530	1785	SRPG400A175	\$106.00										
200	605	2040	SRPG400A200	\$106.00										
225	680	2295	SRPG400A225	\$106.00		3	SGLA36AT0400	\$3487.00	SGPA36AT0400	\$4653.00	3-pole lug kit	TCLK365 ²	\$42.00	(2) 2/0-500 Al or (1) 6-600 Al
250	755	2550	SRPG400A250	\$106.00										
300	905	3060	SRPG400A300	\$106.00										
350	1060	3570	SRPG400A350	\$106.00										
400	1210	4080	SRPG400A400	\$106.00										

SG600 Line, Suitable for Reverse Feed, UL File E-11592, CSA LR 40350

GO-135S

SGL, SGP UL Current Limiting

UL/CSA: 600A, 600 Vac Max., IEC 947-2: 630A, 690 Vac Max.

Rating Plug					Frame					Terminal Lugs for Front Connection (Cu/Al)				
Ampere Rating	Adjustable Instantaneous Trip Ampere Range		Product Number	List Price	Current Sensor	Poles	UL 489 IC @480 Vac		UL 489 IC @480 Vac		Product Number	List Price	Wire Range	
	Low	High					35kA		65kA					
250	765	2530	SRPG600A250	\$106.00	600	2	SGHA26AT0600	\$2663.00	SGLA26AT0600	\$3545.00	2-pole lug kit	TCLK265 ²	\$28.00	(2) 2/0-500 Cu or (1) 8-600 Cu
300	915	3035	SRPG600A300	\$106.00										
350	1070	3545	SRPG600A350	\$106.00										
400	1220	4050	SRPG600A400	\$106.00										
450	1375	4555	SRPG600A450	\$106.00		3	SGHA36AT0600	\$3354.00	SGLA36AT0600	\$4270.00	3-pole lug kit	TCLK365 ²	\$42.00	(2) 2/0-500 Al or (1) 6-600 Al
500	1525	5060	SRPG600A500	\$106.00										
600	1830	6075	SRPG600A600	\$106.00										

¹Rated 240 Vac max.

²Order one kit for either line or load end; two kits required for both.

MOLDED CASE CIRCUIT BREAKERS

3



Industrial Circuit Breakers

125-600A Circuit Breakers

Electronic Trip

Spectra RMS

SG600

Digital, Solid-State Spectra RMS Breakers

SG600 Line, Suitable for Reverse Feed, UL File E-11592, CSA LR 40350

GO-135S

SGL, SGP UL Current Limiting

UL/CSA: 600A, 600 Vac Max., IEC 947-2: 630A, 690 Vac Max.

Rating Plug					Frame				Terminal Lugs for Front Connection (Cu/Al)		
Ampere Rating	Adjustable Instantaneous Trip Ampere Range		Product Number	List Price	UL 489 IC @480 Vac				Product Number	List Price	Wire Range
	Low	High			Current Sensor	Poles	100kA				
							Product Number	List Price			
250	765	2530	SRPG600A250	\$106.00	600	2	SGPA26AT0600	\$4607.00	2-pole lug kit	(2) 2/0-500 Cu or (1) 8-600 Cu	
300	915	3035	SRPG600A300	\$106.00							
350	1070	3545	SRPG600A350	\$106.00							
400	1220	4050	SRPG600A400	\$106.00							
450	1375	4555	SRPG600A450	\$106.00							
500	1525	5060	SRPG600A500	\$106.00							
600	1830	6075	SRPG600A600	\$106.00	3	SGPA36AT0600	\$5548.00	3-pole lug kit	(2) 2/0-500 Al or (1) 6-600 Al		

¹Order one kit for either line or load end; two kits required for both.

SG600 Line, Suitable for Reverse Feed, UL File E-11592, CSA LR 40350

GO-135S

SGL, SGP UL Current Limiting

100% UL Rated, 3-Pole: 400A, 600 Vac Max.; IEC 947-2: 400A, 690 Vac Max.

Rating Plug					Frame					Terminal Lugs for Front Connection (Cu/Al)			
Ampere Rating	Adjustable Instantaneous Trip Ampere Range		Product Number	List Price	UL 489 IC @480 Vac		UL 489 IC @480 Vac			Product Number	List Price	Wire Range	
	Low	High			Current Sensor	Poles	35kAIC		65kAIC				
							Product Number	List Price	Product Number	List Price			
125	380	1275	SRPG400A125	\$106.00	400	3	SGHH36AT0400	\$4381.00	SGLL36AT0400	\$5501.00	TCLK365	\$42.00	(2) 2/0-500 Cu or (1) 8-600 Cu
150	455	1530	SRPG400A150	\$106.00									
175	530	1785	SRPG400A175	\$106.00									
200	605	2040	SRPG400A200	\$106.00									
225	680	2295	SRPG400A225	\$106.00									
250	755	2550	SRPG400A250	\$106.00									
300	905	3060	SRPG400A300	\$106.00									
350	1060	3570	SRPG400A350	\$106.00									
400	1210	4080	SRPG400A400	\$106.00									

SG600 Line, Suitable for Reverse Feed, UL File E-11592, CSA LR 40350

GO-135S

SGL, SGP UL Current Limiting

100% UL Rated, 3-Pole: 400A, 600 Vac Max.; IEC 947-2: 400A, 690 Vac Max.

Rating Plug					Frame				Terminal Lugs for Front Connection (Cu/Al)		
Ampere Rating	Adjustable Instantaneous Trip Ampere Range		Product Number	List Price	UL 489 IC @480 Vac				Product Number	List Price	Wire Range
	Low	High			Current Sensor	Poles	100kAIC				
							Product Number	List Price	Product Number	List Price	
125	380	1275	SRPG400A125	\$106.00	400	3	SGPP36AT0400	\$6049.00	TCLK365	\$42.00	(2) 2/0-500 Cu or (1) 8-600 Cu
150	455	1530	SRPG400A150	\$106.00							
175	530	1785	SRPG400A175	\$106.00							
200	605	2040	SRPG400A200	\$106.00							
225	680	2295	SRPG400A225	\$106.00							
250	755	2550	SRPG400A250	\$106.00							
300	905	3060	SRPG400A300	\$106.00							
350	1060	3570	SRPG400A350	\$106.00							
400	1210	4080	SRPG400A400	\$106.00							

Publications and Reference: See Section 21 for a list of additional product-related publications



MOLDED CASE CIRCUIT BREAKERS

3

Industrial Circuit Breakers

125-600A Circuit Breakers

Electronic Trip

Spectra RMS

SG600

Digital, Solid-State Spectra RMS Breakers

SG600 Line, Suitable for Reverse Feed, UL File E-11592, CSA LR 40350

GO-135S

SGL, SGP UL Current Limiting

100% UL Rated, 3-Pole: 600A, 600 Vac Max.; IEC 947-2: 630A, 690 Vac Max.

Rating Plug					Frame					Terminal Lugs for Front Connection (Cu/Al)			
Ampere Rating	Adjustable Instantaneous Trip Ampere Range		Product Number	List Price	UL 489 IC @480 Vac			UL 489 IC @480 Vac		Product Number	List Price	Wire Range	
	Low	High			Current Sensor	Poles	Product Number	List Price	Product Number				List Price
250	765	2530	SRPG600A250	\$106.00	600	3	SGHH36AT0600	\$5451.00	SGLL36AT0600	\$6783.00	TCLK365	\$42.00	(2) 2/0-500 Cu or (1) 8-600 Cu
300	915	3035	SRPG600A300	\$106.00									
350	1070	3545	SRPG600A350	\$106.00									
400	1220	4050	SRPG600A400	\$106.00									
450	1375	4555	SRPG600A450	\$106.00									
500	1525	5060	SRPG600A500	\$106.00									
600	1830	6075	SRPG600A600	\$106.00									

SG600 Line, Suitable for Reverse Feed, UL File E-11592, CSA LR 40350

GO-135S

SGL, SGP UL Current Limiting

100% UL Rated, 3-Pole: 600A, 600 Vac Max.; IEC 947-2: 630A, 690 Vac Max.

Rating Plug					Frame					Terminal Lugs for Front Connection (Cu/Al)		
Ampere Rating	Adjustable Instantaneous Trip Ampere Range		Product Number	List Price	UL 489 IC @480 Vac			UL 489 IC @480 Vac		Product Number	List Price	Wire Range
	Low	High			Current Sensor	Poles	Product Number	List Price	Product Number			
250	765	2530	SRPG600A250	\$106.00	600	3	SGPP36AT0600	\$7212.00	SGLL36AT0600	TCLK365	\$42.00	(2) 2/0-500 Cu or (1) 8-600 Cu
300	915	3035	SRPG600A300	\$106.00								
350	1070	3545	SRPG600A350	\$106.00								
400	1220	4050	SRPG600A400	\$106.00								
450	1375	4555	SRPG600A450	\$106.00								
500	1525	5060	SRPG600A500	\$106.00								
600	1830	6075	SRPG600A600	\$106.00								

MOLDED CASE CIRCUIT BREAKERS

3

www.DataSheet4U.com



Industrial Circuit Breakers

60-600A Circuit Breakers

Electronic Trip

Spectra RMS

SG600 with MicroVersaTrip Plus and PM

MicroVersaTrip Plus, Standard UL Rated

GO-135S

SG600 Line, Suitable for Reverse Feed, UL File E-11592, CSA LR 40350

SGL, SGP UL Current Limiting; 3-Pole, UL/CSA: 600 Vac Max., IEC 947-2: 630A, 690 Vac Max.

		Frame						Terminal Lugs for Front connection (Cu/Al)		
		IC @480 Vac, UL 489		IC @480 Vac, UL 489		IC @480 Vac, UL 489				
Current Sensor	Trip Function	35kA		65kA		100kA		Product Number	List Price	Wire Range
		Product Number	List Price	Product Number	List Price	Product Number	List Price			
150	LIT	SGHB36BA0150	\$2597.00	SGLB36BA0150	\$3752.00	SGPB36BA0150	\$4932.00	3-Pole lug kit TCLK365 ³	\$42.00	(2) 2/0-500 Cu or (1) 8-600 Cu
	LSIT	SGHB36BB0150	\$3962.00	SGLB36BB0150	\$5117.00	SGPB36BB0150	\$6297.00			
	LIGT ¹	SGHB36BC0150	\$3807.00	SGLB36BC0150	\$4962.00	SGPB36BC0150	\$6142.00			
	LSIGT ¹	SGHB36BD0150	\$5172.00	SGLB36BD0150	\$6327.00	SGPB36BD0150	\$7507.00			
	LIT-CP ²	SGHB36BE0150	\$2897.00	SGLB36BE0150	\$4052.00	SGPB36BE0150	\$5232.00			
	LSIT-CP ²	SGHB36BF0150	\$4262.00	SGLB36BF0150	\$5417.00	SGPB36BF0150	\$6597.00			
400	LIT	SGHB36BA0400	\$2597.00	SGLB36BA0400	\$3752.00	SGPB36BA0400	\$4932.00			(2) 2/0-500 Al or (1) 6-600 Al
	LSIT	SGHB36BB0400	\$3962.00	SGLB36BB0400	\$5117.00	SGPB36BB0400	\$6297.00			
	LIGT ¹	SGHB36BC0400	\$3807.00	SGLB36BC0400	\$4962.00	SGPB36BC0400	\$6142.00			
	LSIGT ¹	SGHB36BD0400	\$5172.00	SGLB36BD0400	\$6327.00	SGPB36BD0400	\$7507.00			
	LIT-CP ²	SGHB36BE0400	\$2897.00	SGLB36BE0400	\$4052.00	SGPB36BE0400	\$5232.00			
	LSIT-CP ²	SGHB36BF0400	\$4262.00	SGLB36BF0400	\$5417.00	SGPB36BF0400	\$6597.00			
600	LIT	SGHB36BA0600	\$3551.00	SGLB36BA0600	\$4505.00	SGPB36BA0600	\$5880.00			
	LSIT	SGHB36BB0600	\$4916.00	SGLB36BB0600	\$5870.00	SGPB36BB0600	\$7245.00			
	LIGT ¹	SGHB36BC0600	\$4761.00	SGLB36BC0600	\$5715.00	SGPB36BC0600	\$7090.00			
	LSIGT ¹	SGHB36BD0600	\$6126.00	SGLB36BD0600	\$7080.00	SGPB36BD0600	\$8455.00			
	LIT-CP ²	SGHB36BE0600	\$3851.00	SGLB36BE0600	\$4805.00	SGPB36BE0600	\$6180.00			
	LSIT-CP ²	SGHB36BF0600	\$5216.00	SGLB36BF0600	\$6170.00	SGPB36BF0600	\$7545.00			

MicroVersaTrip Plus, 100% UL Rate⁴

GO-135S

SG600 Line, Suitable for Reverse Feed, UL File E-11592, CSA LR 40350

SGL, SGP UL Current Limiting; 3-Pole, UL/CSA: 600 Vac Max., IEC 947-2: 630A, 690 Vac Max.

		Frame						Terminal Lugs for Front connection (Cu/Al)		
		IC @480 Vac, UL 489		IC @480 Vac, UL 489		IC @480 Vac, UL 489				
Current Sensor	Trip Function	35kA		65kA		100kA		Product Number	List Price	Wire Range
		Product Number	List Price	Product Number	List Price	Product Number	List Price			
150	LIT	SGHH36BA0150	\$4774.00	SGLL36BA0150	\$5919.00	SGPP36BA0150	\$6412.00	3-Pole lug kit TCLK365 ³	\$42.00	(2) 2/0-500 Al or (1) 6-600 Al
	LSIT	SGHH36BB0150	\$6139.00	SGLL36BB0150	\$7284.00	SGPP36BB0150	\$7777.00			
	LIGT ¹	SGHH36BC0150	\$5984.00	SGLL36BC0150	\$7129.00	SGPP36BC0150	\$7622.00			
	LSIGT ¹	SGHH36BD0150	\$7349.00	SGLL36BD0150	\$8494.00	SGPP36BD0150	\$8987.00			
	LIT-CP ²	SGHH36BE0150	\$5074.00	SGLL36BE0150	\$6219.00	SGPP36BE0150	\$6712.00			
	LSIT-CP ²	SGHH36BF0150	\$6439.00	SGLL36BF0150	\$7584.00	SGPP36BF0150	\$8077.00			
400	LIT	SGHH36BA0400	\$4774.00	SGLL36BA0400	\$5919.00	SGPP36BA0400	\$6412.00			(2) 2/0-500 Cu or (1) 8-600 Cu
	LSIT	SGHH36BB0400	\$6139.00	SGLL36BB0400	\$7284.00	SGPP36BB0400	\$7777.00			
	LIGT ¹	SGHH36BC0400	\$5984.00	SGLL36BC0400	\$7129.00	SGPP36BC0400	\$7622.00			
	LSIGT ¹	SGHH36BD0400	\$7349.00	SGLL36BD0400	\$8494.00	SGPP36BD0400	\$8987.00			
	LIT-CP ²	SGHH36BE0400	\$5074.00	SGLL36BE0400	\$6219.00	SGPP36BE0400	\$6712.00			
	LSIT-CP ²	SGHH36BF0400	\$6439.00	SGLL36BF0400	\$7584.00	SGPP36BF0400	\$8077.00			
600	LIT	SGHH36BA0600	\$5771.00	SGLL36BA0600	\$7155.00	SGPP36BA0600	\$7644.00			
	LSIT	SGHH36BB0600	\$7136.00	SGLL36BB0600	\$8520.00	SGPP36BB0600	\$9009.00			
	LIGT ³	SGHH36BC0600	\$6981.00	SGLL36BC0600	\$8365.00	SGPP36BC0600	\$8854.00			
	LSIGT ³	SGHH36BD0600	\$8346.00	SGLL36BD0600	\$9730.00	SGPP36BD0600	\$10219.00			
	LIT-CP ⁴	SGHH36BE0600	\$6071.00	SGLL36BE0600	\$7455.00	SGPP36BE0600	\$7944.00			
	LSIT-CP ⁴	SGHH36BF0600	\$7436.00	SGLL36BF0600	\$8820.00	SGPP36BF0600	\$9309.00			

¹For grounded neutral systems (1**/3w or 3**/4w) a neutral current sensor is required. Refer to page 3-109.

²For +24 Vdc Control Power Accessories refer to pages 3-106 to 3-109.

³Order one kit for either line or load end; two kits required for both.

⁴100% UL rated supplied with back-connected assembly which increases breaker depth. Refer to outline drawing for details.

Publications and Reference: See Section 31 for a list of additional product-related publications



www.DataSheet4U.com

MOLDED CASE CIRCUIT BREAKERS

3

Industrial Circuit Breakers

60-600A Circuit Breakers

Electronic Trip

Spectra RMS

with MicroVersaTrip PM Trip Units¹

MicroVersaTrip PM, Standard UL Rated (No Protective Relays)

GO-135S

SG600 Line, Suitable for Reverse Feed, UL File E-11592, CSA LR 40350

SGL, SGP UL Current Limiting; 3-Pole, UL/CSA: 600 Vac Max., IEC 947-2: 630A, 690 Vac Max.

		Frame						Terminal Lugs for Front connection (Cu/Al)						
		IC @480 Vac, UL 489		IC @480 Vac, UL 489		IC @480 Vac, UL 489								
Current Sensor	Trip Function	35kA		65kA		100kA		Product Number	List Price	Wire Range				
150	LIT	SGHB36CA0150	\$3797.00	SGLB36CA0150	\$4952.00	SGPB36CA0150	\$6132.00	3-Pole lug kit TCLK365 ³	\$42.00	(2) 2/0-500 Cu or (1) 8-600 Cu				
	LSIT	SGHB36CB0150	\$5162.00	SGLB36CB0150	\$6317.00	SGPB36CB0150	\$7497.00							
	LIGT ²	SGHB36CC0150	\$5007.00	SGLB36CC0150	\$6162.00	SGPB36CC0150	\$7342.00							
	LSIGT ²	SGHB36CD0150	\$6372.00	SGLB36CD0150	\$7527.00	SGPB36CD0150	\$8707.00							
400	LIT	SGHB36CA0400	\$3797.00	SGLB36CA0400	\$4952.00	SGPB36CA0400	\$6132.00			3-Pole lug kit TCLK365 ³	\$42.00	(2) 2/0-500 Al or (1) 6-600 Al		
	LSIT	SGHB36CB0400	\$5162.00	SGLB36CB0400	\$6317.00	SGPB36CB0400	\$7497.00							
	LIGT ²	SGHB36CC0400	\$5007.00	SGLB36CC0400	\$6162.00	SGPB36CC0400	\$7342.00							
	LSIGT ²	SGHB36CD0400	\$6372.00	SGLB36CD0400	\$7527.00	SGPB36CD0400	\$8707.00							
600	LIT	SGHB36CA0600	\$4751.00	SGLB36CA0600	\$5705.00	SGPB36CA0600	\$7080.00					3-Pole lug kit TCLK365 ³	\$42.00	(2) 2/0-500 Al or (1) 6-600 Al
	LSIT	SGHB36CB0600	\$6116.00	SGLB36CB0600	\$7070.00	SGPB36CB0600	\$8445.00							
	LIGT ²	SGHB36CC0600	\$5961.00	SGLB36CC0600	\$6915.00	SGPB36CC0600	\$8290.00							
	LSIGT ²	SGHB36CD0600	\$7326.00	SGLB36CD0600	\$8280.00	SGPB36CD0600	\$9655.00							

MicroVersaTrip PM, 100% UL Rated⁴ (No Protective Relays)

GO-135S

SG600 Line, Suitable for Reverse Feed, UL File E-11592, CSA LR 40350

SGL, SGP UL Current Limiting; 3-Pole, UL/CSA: 600 Vac Max., IEC 947-2: 630A, 690 Vac Max.

		Frame						Terminal Lugs for Front connection (Cu/Al)						
		IC @480 Vac, UL 489		IC @480 Vac, UL 489		IC @480 Vac, UL 489								
Current Sensor	Trip Function	35kA		65kA		100kA		Product Number	List Price	Wire Range				
150	LIT	SGHH36CA0150	\$5974.00	SGLL36CA0150	\$7119.00	SGPP36CA0150	\$7612.00	3-Pole lug kit TCLK365 ³	\$42.00	(2) 2/0-500 Cu or (1) 8-600 Cu				
	LSIT	SGHH36CB0150	\$7339.00	SGLL36CB0150	\$8484.00	SGPP36CB0150	\$8977.00							
	LIGT ²	SGHH36CC0150	\$7184.00	SGLL36CC0150	\$8329.00	SGPP36CC0150	\$8822.00							
	LSIGT ²	SGHH36CD0150	\$8549.00	SGLL36CD0150	\$9694.00	SGPP36CD0150	\$10187.00							
400	LIT	SGHH36CA0400	\$5974.00	SGLL36CA0400	\$7119.00	SGPP36CA0400	\$7612.00			3-Pole lug kit TCLK365 ³	\$42.00	(2) 2/0-500 Al or (1) 6-600 Al		
	LSIT	SGHH36CB0400	\$7339.00	SGLL36CB0400	\$8484.00	SGPP36CB0400	\$8977.00							
	LIGT ²	SGHH36CC0400	\$7184.00	SGLL36CC0400	\$8329.00	SGPP36CC0400	\$8822.00							
	LSIGT ²	SGHH36CD0400	\$8549.00	SGLL36CD0400	\$9694.00	SGPP36CD0400	\$10187.00							
600	LIT	SGHH36CA0600	\$6971.00	SGLL36CA0600	\$8355.00	SGPP36CA0600	\$8844.00					3-Pole lug kit TCLK365 ³	\$42.00	(2) 2/0-500 Al or (1) 6-600 Al
	LSIT	SGHH36CB0600	\$8336.00	SGLL36CB0600	\$9720.00	SGPP36CB0600	\$10209.00							
	LIGT ²	SGHH36CC0600	\$8181.00	SGLL36CC0600	\$9565.00	SGPP36CC0600	\$10054.00							
	LSIGT ²	SGHH36CD0600	\$9546.00	SGLL36CD0600	\$10930.00	SGPP36CD0600	\$11419.00							

MicroVersaTrip Plus and PM Rating Plug Selection —

All Plugs List Price, \$106.00

GO-135S

Circuit Breaker Frame	Sensor Rating	Rating Plug Rating (Amperes)	Rating Plug Product No.
SGHB, SGHH, SGLB, SGLL, SGPB, SGPP	150	60	SRPG150B60
		80	SRPG150B80
		100	SRPG150B100
		125	SRPG150B125
	400	150	SRPG150B150
		200	SRPG400B150
		250	SRPG400B200
		300	SRPG400B250
	600	225	SRPG400B225
		300	SRPG400B300
		350	SRPG400B350
		400	SRPG400B400
600	300	SRPG600B300	
	400	SRPG600B400	
	450	SRPG600B450	
	500	SRPG600B500	
		600	SRPG600B600

¹MicroVersaTrip PM Trip Units require 24 Vdc control power and voltage sensing signals. Refer to pages 3-106 to 3-109.

²For grounded neutral systems (1**/3w or 3**4w) a neutral current sensor is required. Refer to page 3-109.

³Order one kit for either line or load end; two kits required for both.

⁴100% UL rated supplied with back-connected assembly which increases breaker depth. Refer to outline drawing for details.



MOLDED CASE CIRCUIT BREAKERS

3

Industrial Circuit Breakers

60-600A Circuit Breakers

Electronic Trip

Spectra RMS

with MicroVersaTrip PM Trip Units¹

MicroVersaTrip PM, Standard UL Rated (With Protective Relaying)

GO-135S

SG600 Line, Suitable for Reverse Feed, UL File E-11592, CSA LR 40350

SGL, SGP UL Current Limiting; 3-Pole, UL/CSA: 600 Vac Max., IEC 947-2: 630A, 690 Vac Max.

		Frame						Terminal Lugs for Front connection (Cu/Al)			
		IC @480 Vac, UL 489		IC @480 Vac, UL 489		IC @480 Vac, UL 489					
Current Sensor	Trip Function	35kA		65kA		100kA		Product Number	List Price	Wire Range	
		Product Number	List Price	Product Number	List Price	Product Number	List Price				
150	LIT	SGHB36DA0150	\$4997.00	SGLB36DA0150	\$6152.00	SGPB36DA0150	\$7332.00	3-Pole lug kit TCLK365 ³	\$42.00	(2) 2/0-500 Cu or (1) 8-600 Cu	
	LSIT	SGHB36DB0150	\$6362.00	SGLB36DB0150	\$7517.00	SGPB36DB0150	\$8697.00				
	LIGT ²	SGHB36DC0150	\$6207.00	SGLB36DC0150	\$7362.00	SGPB36DC0150	\$8542.00				
	LSIGT ²	SGHB36DD0150	\$7572.00	SGLB36DD0150	\$8727.00	SGPB36DD0150	\$9907.00				
400	LIT	SGHB36DA0400	\$4997.00	SGLB36DA0400	\$6152.00	SGPB36DA0400	\$7332.00			(2) 2/0-500 Al or (1) 6-600 Al	
	LSIT	SGHB36DB0400	\$6362.00	SGLB36DB0400	\$7517.00	SGPB36DB0400	\$8697.00				
	LIGT ²	SGHB36DC0400	\$6207.00	SGLB36DC0400	\$7362.00	SGPB36DC0400	\$8542.00				
	LSIGT ²	SGHB36DD0400	\$7572.00	SGLB36DD0400	\$8727.00	SGPB36DD0400	\$9907.00				
600	LIT	SGHB36DA0600	\$5951.00	SGLB36DA0600	\$6905.00	SGPB36DA0600	\$8280.00				
	LSIT	SGHB36DB0600	\$7316.00	SGLB36DB0600	\$8270.00	SGPB36DB0600	\$9645.00				
	LIGT ²	SGHB36DC0600	\$7161.00	SGLB36DC0600	\$8115.00	SGPB36DC0600	\$9490.00				
	LSIGT ²	SGHB36DD0600	\$8526.00	SGLB36DD0600	\$9480.00	SGPB36DD0600	\$10855.00				

MicroVersaTrip PM, 100% UL Rated⁴ (With Protective Relays)

GO-135S

SG600 Line, Suitable for Reverse Feed, UL File E-11592, CSA LR 40350

SGL, SGP UL Current Limiting; 3-Pole, UL/CSA: 600 Vac Max., IEC 947-2: 630A, 690 Vac Max.

		Frame						Terminal Lugs for Front connection (Cu/Al)			
		IC @480 Vac, UL 489		IC @480 Vac, UL 489		IC @480 Vac, UL 489					
Current Sensor	Trip Function	35kA		65kA		100kA		Product Number	List Price	Wire Range	
		Product Number	List Price	Product Number	List Price	Product Number	List Price				
150	LIT	SGHH36DA0150	\$7174.00	SGLL36DA0150	\$8319.00	SGPP36DA0150	\$8812.00	3-Pole lug kit TCLK365 ³	\$42.00	(2) 2/0-500 Cu or (1) 6-600 Cu	
	LSIT	SGHH36DB0150	\$8539.00	SGLL36DB0150	\$9684.00	SGPP36DB0150	\$10177.00				
	LIGT ²	SGHH36DC0150	\$8384.00	SGLL36DC0150	\$9529.00	SGPP36DC0150	\$10022.00				
	LSIGT ²	SGHH36DD0150	\$9749.00	SGLL36DD0150	\$10894.00	SGPP36DD0150	\$11387.00				
400	LIT	SGHH36DA0400	\$7174.00	SGLL36DA0400	\$8319.00	SGPP36DA0400	\$8812.00			(2) 2/0-500 Al or (1) 8-600 Al	
	LSIT	SGHH36DB0400	\$8539.00	SGLL36DB0400	\$9684.00	SGPP36DB0400	\$10177.00				
	LIGT ²	SGHH36DC0400	\$8384.00	SGLL36DC0400	\$9529.00	SGPP36DC0400	\$10022.00				
	LSIGT ²	SGHH36DD0400	\$9749.00	SGLL36DD0400	\$10894.00	SGPP36DD0400	\$11387.00				
600	LIT	SGHH36DA0600	\$8171.00	SGLL36DA0600	\$9555.00	SGPP36DA0600	\$10044.00				
	LSIT	SGHH36DB0600	\$9536.00	SGLL36DB0600	\$10920.00	SGPP36DB0600	\$11409.00				
	LIGT ²	SGHH36DC0600	\$9381.00	SGLL36DC0600	\$10765.00	SGPP36DC0600	\$11254.00				
	LSIGT ²	SGHH36DD0600	\$10746.00	SGLL36DD0600	\$12130.00	SGPP36DD0600	\$12619.00				

MicroVersaTrip Plus and PM Rating Plug Selection —

All Plugs List Price, \$106.00

GO-135S

Circuit Breaker Frame	Sensor Rating	Rating Plug Rating (Amperes)	Rating Plug Product No.
SGHB, SGHH, SGLB, SGLL, SGPB, SGPP	150	60	SRPG150B60
		80	SRPG150B80
		100	SRPG150B100
		125	SRPG150B125
		150	SRPG150B150
	400	150	SRPG400B150
		200	SRPG400B200
		225	SRPG400B225
		250	SRPG400B250
		300	SRPG400B300
600	350	SRPG400B350	
	400	SRPG400B400	
	300	SRPG600B300	
	400	SRPG600B400	
	450	SRPG600B450	
	500	SRPG600B500	
		600	SRPG600B600

www.DataSheet4U.com

¹MicroVersaTrip PM Trip Units require 24 Vdc control power and voltage sensing signals. Refer to pages 3-106 to 3-109.

²For grounded neutral systems (1**3w or 3**4w) a neutral current sensor is required. Refer to page 3-109.

³Order one kit for either line or load end; two kits required for both.

⁴100% UL rated supplied with back-connected assembly which increases breaker depth. Refer to outline drawing for details.

Publications and Reference: See Section 21
for a list of additional product-related publications



www.DataSheet4U.com

MOLDED CASE CIRCUIT BREAKERS 3

Industrial Circuit Breakers

125-600A Circuit Breakers
 Thermal-Magnetic Trip
 J600 Line Circuit Breakers
 Types TJJ, TJK, THJK

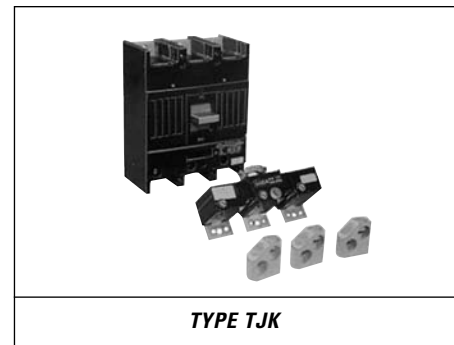

Type TJJ Noninterchangeable Trip (includes Line and Load Lugs), suitable for reverse feed GO-135B

Ampere Rating	Adjustable Instantaneous Trip Ampere Range		2-Pole, 400 Ampere Frame 600 Vac, 250 Vdc		3-Pole, 400 Ampere Frame 600 Vac		Terminal Lugs for Front Connection (Cu/Al)	
	Low	High	Product Number	List Price	Product Number	List Price	Copper/ Aluminum Lugs	Wire Size
125	375	1250	TJJ426125WL	\$2118.00	TJJ436125WL	\$2573.00	TCAL43 ² Included in price of breaker	(1) 6-600 or (2) 2/0-250 Cu/Al
150	450	1500	TJJ426150WL	\$2118.00	TJJ436150WL	\$2573.00		
175	525	1750	TJJ426175WL	\$2118.00	TJJ436175WL	\$2573.00		
200	600	2000	TJJ426200WL	\$2118.00	TJJ436200WL	\$2573.00		
225	675	2250	TJJ426225WL	\$2118.00	TJJ436225WL	\$2573.00		
250	750	2500	TJJ426250WL	\$2118.00	TJJ436250WL	\$2573.00		
300	900	3000	TJJ426300WL	\$2118.00	TJJ436300WL	\$2573.00		
350	1050	3500	TJJ426350WL	\$2118.00	TJJ436350WL	\$2573.00		
400	1200	4000	TJJ426400WL	\$2118.00	TJJ436400WL	\$2573.00		

Types TJK, THJK — Interchangeable Trip, not suitable for reverse feed GO-135B

Complete Circuit Breaker Includes Line and Load Lugs										Terminal Lugs for Front Connection (Cu/Al) ¹			
Ampere Rating	Adjustable Instantaneous Trip Ampere Range		Standard Product Number	List Price	Hi-Break Product Number	List Price	Frame Only Product Number	List Price	Trip Unit Only. Use with Standard and Hi-Break Frames	List Price	Product Number (Order 2 per pole)	List Price	Wire Size
	Low	High											
400A Frame — Two-Pole													
125	375	1250	TJK426125WL	\$2118.00	THJK426125WL	\$3085.00			TJK426T125	\$464.00	TCAL43 ²	\$14.00	(1) 6-600 or (2) 2/0-250 Cu/Al
150	450	1500	TJK426150WL	\$2118.00	THJK426150WL	\$3085.00	TJK426F000	\$1598.00	TJK426T150	\$464.00			
175	525	1750	TJK426175WL	\$2118.00	THJK426175WL	\$3085.00	Standard		TJK426T175	\$464.00			
200	600	2000	TJK426200WL	\$2118.00	THJK426200WL	\$3085.00	Frame		TJK426T200	\$464.00			
225	675	2250	TJK426225WL	\$2118.00	THJK426225WL	\$3085.00			TJK426T225	\$464.00			
250	750	2500	TJK426250WL	\$2118.00	THJK426250WL	\$3085.00			TJK426T250	\$464.00			
300	900	3000	TJK426300WL	\$2118.00	THJK426300WL	\$3085.00			TJK426T300	\$464.00			
350	1050	3500	TJK426350WL	\$2118.00	THJK426350WL	\$3085.00	THJK426F000	\$2565.00	TJK426T350	\$464.00			
400	1200	4000	TJK426400WL	\$2118.00	THJK426400WL	\$3085.00	Hi-Break		TJK426T400	\$464.00			
400A Frame — Three-Pole													
125	375	1250	TJK436125WL	\$2573.00	THJK436125WL	\$3675.00			TJK436T125	\$464.00	TCAL43 ²	\$14.00	(1) 6-600 or (2) 2/0-250 Cu/Al
150	450	1500	TJK436150WL	\$2573.00	THJK436150WL	\$3675.00	TJK436F000	\$2025.00	TJK436T150	\$464.00			
175	525	1750	TJK436175WL	\$2573.00	THJK436175WL	\$3675.00	Standard		TJK436T175	\$464.00			
200	600	2000	TJK436200WL	\$2573.00	THJK436200WL	\$3675.00	Frame		TJK436T200	\$464.00			
225	675	2250	TJK436225WL	\$2573.00	THJK436225WL	\$3675.00			TJK436T225	\$464.00			
250	750	2500	TJK436250WL	\$2573.00	THJK436250WL	\$3675.00			TJK436T250	\$464.00			
300	900	3000	TJK436300WL	\$2573.00	THJK436300WL	\$3675.00			TJK436T300	\$464.00			
350	1050	3500	TJK436350WL	\$2573.00	THJK436350WL	\$3675.00	THJK436F000	\$3127.00	TJK436T350	\$464.00			
400	1200	4000	TJK436400WL	\$2573.00	THJK436400WL	\$3675.00	Hi-Break		TJK436T400	\$464.00			
400	600	2000	—	—	—	—	—	—	TJK436TM1400 ³	\$558.00			
Mag Only	1200	4000	—	—	—	—	—	—	TJK436TM2400 ³	\$558.00			
	350	1000	—	—	—	—	—	—	TJK436TM3400 ³	\$558.00			

¹For optional lugs, see page 3-101.

²Not UL listed.

³Alternate lug for 750 kcmil Cu/Al cable, Product Number TCAL47 List Price \$26.00, GO-135B.

Accessories: See pages 3-85 to 3-104.

MOLDED CASE CIRCUIT BREAKERS

3



Industrial Circuit Breakers

125-600A Circuit Breakers

Thermal-Magnetic Trip

J600 Line Circuit Breakers

Types TJJ, TJK, THJK

Types TJK, THJK — Interchangeable Trip

GO-135S

Complete Circuit Breaker Includes Line and Load Lugs							Terminal Lugs for Front Connection (Cu/Al) ¹						
Amperes Rating	Adjustable Instantaneous Trip Ampere Range		Standard Product Number	List Price	Hi-Break Product Number	List Price	Frame Only Product Number	List Price	Trip Unit Only. Use with Standard and Hi-Break Frames	List Price	Product Number (Order 2 per pole)	List Price	Wire Size
	Low	High											
600A Frame — Two-Pole													
250	750	2500	TJK626250WL	\$2812.00	THJK626250WL	\$3704.00			TJK626T250	\$1221.00	TCAL43 ²	\$14.00	(1) 6-600 or (2) 2/0-250 Cu/Al
300	900	3000	TJK626300WL	\$2812.00	THJK626300WL	\$3704.00	TJK626F000	\$1535.00	TJK626T300	\$1221.00			
350	1050	3500	TJK626350WL	\$2812.00	THJK626350WL	\$3704.00	Standard		TJK626T350	\$1221.00			
400	1200	4000	TJK626400WL	\$2812.00	THJK626400WL	\$3704.00	Frame		TJK626T400	\$1221.00			
450	1350	4500	TJK626450WL	\$2848.00	THJK626450WL	\$3740.00	THJK626F000		TJK626T450	\$1221.00			(2) 4/0-350 Cu
500	1500	5000	TJK626500WL	\$2848.00	THJK626500WL	\$3740.00	Hi-Break	\$2427.00	TJK626T500	\$1221.00	TCAL63	\$23.00	or
600	1800	6000	TJK626600WL	\$2848.00	THJK626600WL	\$3740.00	Frame		TJK626T600	\$1221.00			(2) 300-500 Al
600A Frame — Three-Pole													
250	750	2500	TJK636250WL	\$3539.00	THJK636250WL	\$4457.00			TJK636T250	\$1221.00	TCAL43 ²	\$14.00	(1) 6-600 or (2) 2/0-250 Cu/Al
300	900	3000	TJK636300WL	\$3539.00	THJK636300WL	\$4457.00	TJK636F000	\$2234.00	TJK636T300	\$1221.00			
350	1050	3500	TJK636350WL	\$3539.00	THJK636350WL	\$4457.00	Standard		TJK636T350	\$1221.00			
400	1200	4000	TJK636400WL	\$3539.00	THJK636400WL	\$4457.00	Frame		TJK636T400	\$1221.00			
450	1350	4500	TJK636450WL	\$3593.00	THJK636450WL	\$4511.00	THJK636F000		TJK636T450	\$1221.00			(2) 4/0-350 Cu
500	1500	5000	TJK636500WL	\$3593.00	THJK636500WL	\$4511.00	Hi-Break	\$3152.00	TJK636T500	\$1221.00	TCAL63	\$23.00	or
600	1800	600	TJK636600WL	\$3593.00	THJK636600WL	\$4511.00	Frame		TJK636T600	\$1221.00			(2) 300-500 Al
600	6000	2000	—	—	—	—			TJK636TM1600 ³	\$1465.00			
Mag Only	1800	6000	—	—	—	—			TJK636TM2600 ³	\$1465.00			

¹For optional lugs, see page 3-101.

²Alternate lug for 750 kcmil Cu/Al cable, Product Number TCAL47 List Price \$26.00, GO-135B.

³Not UL listed.

Accessories: See pages 3-85 to 3-104.



Industrial Circuit Breakers

300-1200A Circuit Breakers

Electronic Trip

Spectra RMS

SK1200 Line, Suitable for Reverse Feed, UL File E-11592, CSA LR 40350

GO-135S

UL/CSA: 800A, 600 Vac Max., IEC 947-2:800A 690 Vac Max.

Rating Plug					Frame					Terminal Lugs for Front Connection (Cu/Al)				
Ampere Rating	Adjustable Instantaneous Trip Ampere Range		Product Number	List Price	UL 489 IC @480 Vac				Product Number	List Price	Wire Range			
	Low	High			Current Sensor	Poles	Product Number	List Price				Product Number	List Price	
300	940	3015	SRPK800A300	\$106.00	800	2	SKHA26AT0800	\$3377.00	SKLA26AT0800	\$4301.00	TCAL81	\$47.00	(3) 3/0-500 Cu	
400	1255	4015	SRPK800A400	\$106.00										
500	1570	5020	SRPK800A500	\$106.00										
600	1875	6195	SRPK800A600	\$106.00										
700	2155	7420	SRPK800A700	\$106.00										
800	2440	8705	SRPK800A800	\$106.00										

SK1200 Line, Suitable for Reverse Feed, UL File E-11592, CSA LR 40350

GO-135S

UL/CSA: 800A, 600 Vac Max., IEC 947-2:800A 690 Vac Max.

Rating Plug					Frame					Terminal Lugs for Front Connection (Cu/Al)				
Ampere Rating	Adjustable Instantaneous Trip Ampere Range		Product Number	List Price	UL 489 IC @480 Vac				Product Number	List Price	Wire Range			
	Low	High			Current Sensor	Poles	Product Number	List Price				Product Number	List Price	
300	940	3015	SRPK800A300	\$106.00	800	2	SKPA26AT0800	\$6746.00	SKLA26AT0800	\$4301.00	TCAL81	\$47.00	(3) 3/0-500 Cu	
400	1255	4015	SRPK800A400	\$106.00										
500	1570	5020	SRPK800A500	\$106.00										
600	1875	6195	SRPK800A600	\$106.00										
700	2155	7420	SRPK800A700	\$106.00										
800	2440	8705	SRPK800A800	\$106.00										

SK1200 Line, Suitable for Reverse Feed, UL File E-11592, CSA LR 40350

GO-135S

UL/CSA: 1200A, 600 Vac Max., IEC 947-2: 1250A, 690 Vac Max.

Rating Plug					Frame					Terminal Lugs for Front Connection (Cu/Al)				
Ampere Rating	Adjustable Instantaneous Trip Ampere Range		Product Number	List Price	UL 489 IC @480 Vac				Product Number	List Price	Wire Range			
	Low	High			Current Sensor	Poles	Product Number	List Price				Product Number	List Price	
600	1825	6110	SRPK1200A600	\$106.00	1200	2	SKHA26AT1200	\$7057.00	SKLA26AT1200	\$7958.00	TCAL125	\$76.00	(4) 250-500 Cu ¹	
700	2125	7125	SRPK1200A700	\$106.00										
800	2430	8145	SRPK1200A800	\$106.00										
1000	3040	10180	SRPK1200A1000	\$106.00										
1200	3650	12215	SRPK1200A1200	\$106.00										

SK1200 Line, Suitable for Reverse Feed, UL File E-11592, CSA LR 40350

GO-135S

UL/CSA: 1200A, 600 Vac Max., IEC 947-2: 1250A, 690 Vac Max.

Rating Plug					Frame					Terminal Lugs for Front Connection (Cu/Al)				
Ampere Rating	Adjustable Instantaneous Trip Ampere Range		Product Number	List Price	UL 489 IC @480 Vac				Product Number	List Price	Wire Range			
	Low	High			Current Sensor	Poles	Product Number	List Price				Product Number	List Price	
600	1825	6110	SRPK1200A600	\$106.00	1200	2	SKPA26AT1200	\$10136.00	SKLA26AT1200	\$7958.00	TCAL125	\$76.00	(4) 250-500 Cu ¹	
700	2125	7125	SRPK1200A700	\$106.00										
800	2430	8145	SRPK1200A800	\$106.00										
1000	3040	10180	SRPK1200A1000	\$106.00										
1200	3650	12215	SRPK1200A1200	\$106.00										

¹Suitable for 500 kcmil copper for voltage drop consideration, 1200 ampere max. rating.

MOLDED CASE CIRCUIT BREAKERS

3



Industrial Circuit Breakers
300-1200A Circuit Breakers
Electronic Trip
Spectra RMS

SK1200 Line, Suitable for Reverse Feed, UL File E-11592, CSA LR 40350 **GO-135S**

100% UL Rated, 3-Pole: 800A, 600 Vac Max.; IEC 947-2: 800A, 690 Vac Max.

Rating Plug					Frame					Terminal Lugs for Front Connection (Cu/Al)			
Ampere Rating	Adjustable Instantaneous Trip Ampere Range		Product Number	List Price	UL 489 IC @480 Vac				Product Number	List Price	Wire Range		
	Low	High			50kA		65kA						
					Current Sensor	Poles	Product Number	List Price				Product Number	List Price
300	940	3015	SRPK800A300	\$106.00	800	3	SKHH36AT0800	\$7514.00	SKLL36AT0800	\$9325.00	TCAL81	\$47.00	(3) 3/0-500 Cu
400	1255	4015	SRPK800A400	\$106.00									
500	1570	5020	SRPK800A500	\$106.00									
600	1875	6195	SRPK800A600	\$106.00									
700	2155	7420	SRPK800A700	\$106.00									
800	2440	8705	SRPK800A800	\$106.00									

SK1200 Line, Suitable for Reverse Feed, UL File E-11592, CSA LR 40350 **GO-135S**

100% UL Rated, 3-Pole: 800A, 600 Vac Max.; IEC 947-2: 800A, 690 Vac Max.

Rating Plug					Frame				Terminal Lugs for Front Connection (Cu/Al)		
Ampere Rating	Adjustable Instantaneous Trip Ampere Range		Product Number	List Price	UL 489 IC @480 Vac				Product Number	List Price	Wire Range
	Low	High			100kA						
					Current Sensor	Poles	Product Number	List Price			
300	940	3015	SRPK800A300	\$106.00	800	3	SKPP36AT0800	\$10712.00	TCAL81	\$47.00	(3) 3/0-500 Cu
400	1255	4015	SRPK800A400	\$106.00							
500	1570	5020	SRPK800A500	\$106.00							
600	1875	6195	SRPK800A600	\$106.00							
700	2155	7420	SRPK800A700	\$106.00							
800	2440	8705	SRPK800A800	\$106.00							

SK1200 Line, Suitable for Reverse Feed, UL File E-11592, CSA LR 40350 **GO-135S**

100% UL Rated, 3-Pole: 1000A, 600 Vac Max.; IEC 947-2: 1000A, 690 Vac Max.

Rating Plug					Frame					Terminal Lugs for Front Connection (Cu/Al)			
Ampere Rating	Adjustable Instantaneous Trip Ampere Range		Product Number	List Price	UL 489 IC @480 Vac				Product Number	List Price	Wire Range		
	Low	High			50kA		65kA						
					Current Sensor	Poles	Product Number	List Price				Product Number	List Price
600	1825	6110	SRPK1200A600	\$106.00	1200	3	SKHH36AT1000	\$11051.00	SKLL36AT1000	\$13678.00	TCAL125	\$76.00	(4) 250-500 Cu ²
700	2125	7125	SRPK1200A700	\$106.00									
800	2430	8145	SRPK1200A800	\$106.00									
1000	3040	10180	SRPK1200A1000	\$106.00									
1200	3650	12215	SRPL1200A1200	\$106.00									

SK1200 Line, Suitable for Reverse Feed, UL File E-11592, CSA LR 40350 **GO-135S**

100% UL Rated, 3-Pole: 1000A, 600 Vac Max.; IEC 947-2: 1000A, 690 Vac Max.

Rating Plug					Frame				Terminal Lugs for Front Connection (Cu/Al)		
Ampere Rating	Adjustable Instantaneous Trip Ampere Range		Product Number	List Price	UL 489 IC @480 Vac				Product Number	List Price	Wire Range
	Low	High			100kA						
					Current Sensor	Poles	Product Number	List Price			
600	1825	6110	SRPK1200A600	\$106.00	1200	3	SKPP36AT1000	\$14538.00	TCAL125	\$76.00	(4) 250-500 Cu ²
700	2125	7125	SRPK1200A700	\$106.00							
800	2430	8145	SRPK1200A800	\$106.00							
1000	3040	10180	SRPK1200A1000	\$106.00							
1200	3650	12215	SRKP1200A1200	\$106.00							

¹100% UL rated SK1200 supplied with back-connected assembly which increases breaker depth. Refer to outline drawings for details.

²Suitable for 500 kcmil copper for voltage drop consideration, 1200A max. rating.

Publications and Reference: See Section 21 for a list of additional product-related publications



MOLDED CASE CIRCUIT BREAKERS

3

Industrial Circuit Breakers

300-1200A Circuit Breakers

Electronic Trip

Spectra RMS

SK1200 with MicroVersaTrip Plus and PM

MicroVersaTrip Plus, Standard UL Rated

GO-135S

SK1200 Line, Suitable for Reverse Feed, UL File E-11592, CSA LR 40350

3-Pole, UL/CSA: 1200A, 600 Vac Max., IEC 947-2: 1250A, 690 Vac Max. (SKL, SKP only)

		Frame						Terminal Lugs for Front connection (Cu/Al)		
		IC @480 Vac, UL 489		IC @480 Vac, UL 489		IC @480 Vac, UL 489				
Current Sensor	Trip Function	50kA Product Number	List Price	65kA Product Number	List Price	100kA Product Number	List Price	Product Number	List Price	Wire Range
800	LIT	SKHB36BA0800	\$4588.00	SKLB36BA0800	\$5552.00	SKPB36BA0800	\$8734.00	TCAL81	\$47.00	(3) 3/0-500 Cu (3) 3/0-500 Al
	LSIT	SKHB36BB0800	\$5953.00	SKLB36BB0800	\$6917.00	SKPB36BB0800	\$10099.00			
	LIGT ¹	SKHB36BC0800	\$5798.00	SKLB36BC0800	\$6762.00	SKPB36BC0800	\$9944.00			
	LSIGT ¹	SKHB36BD0800	\$7163.00	SKLB36BD0800	\$8127.00	SKPB36BD0800	\$11309.00			
	LIT-CP ²	SKHB36BE0800	\$4888.00	SKLB36BE0800	\$5852.00	SKPB36BE0800	\$9034.00			
	LSIT-CP ²	SKHB36BF0800	\$6253.00	SKLB36BF0800	\$7217.00	SKPB36BF0800	\$10399.00			
1200	LIT	SKHB36BA1200	\$8077.00	SKLB36BA1200	\$9048.00	SKPB36BA1200	\$11854.00	TCAL125	\$76.00	(4) 250-350 Cu ³ (4) 250-500 Al
	LSIT	SKHB36BB1200	\$9442.00	SKLB36BB1200	\$10413.00	SKPB36BB1200	\$13219.00			
	LIGT ¹	SKHB36BC1200	\$9287.00	SKLB36BC1200	\$10258.00	SKPB36BC1200	\$13064.00			
	LSIGT ¹	SKHB36BD1200	\$10652.00	SKLB36BD1200	\$11623.00	SKPB36BD1200	\$14429.00			
	LIT-CP ²	SKHB36BE1200	\$8377.00	SKLB36BE1200	\$9348.00	SKPB36BE1200	\$12154.00			
	LSIT-CP ²	SKHB36BF1200	\$9742.00	SKLB36BF1200	\$10713.00	SKPB36BF1200	\$13519.00			

MicroVersaTrip Plus, 100% UL Rated⁴

GO-135S

SK1200 Line, Suitable for Reverse Feed, UL File E-11592, CSA LR 40350

3-Pole, UL/CSA: 1200A, 600 Vac Max., IEC 947-2: 1250A, 690 Vac Max. (SKL, SKP only)

		Frame						Terminal Lugs for Front connection (Cu/Al)		
		IC @480 Vac, UL 489		IC @480 Vac, UL 489		IC @480 Vac, UL 489				
Current Sensor	Trip Function	50kA Product Number	List Price	65kA Product Number	List Price	100kA Product Number	List Price	Product Number	List Price	Wire Range
800	LIT	SKHH36BA0800	\$7975.00	SKLL36BA0800	\$9892.00	SKPP36BA0800	\$11354.00	TCAL81	\$47.00	(3) 3/0-500 Cu (3) 3/0-500 Al
	LSIT	SKHH36BB0800	\$9340.00	SKLL36BB0800	\$11257.00	SKPP36BB0800	\$12719.00			
	LIGT ¹	SKHH36BC0800	\$9185.00	SKLL36BC0800	\$11102.00	SKPP36BC0800	\$12564.00			
	LSIGT ¹	SKHH36BD0800	\$10550.00	SKLL36BD0800	\$12467.00	SKPP36BD0800	\$13929.00			
	LIT-CP ²	SKHH36BE0800	\$8275.00	SKLL36BE0800	\$10192.00	SKPP36BE0800	\$11654.00			
	LSIT-CP ²	SKHH36BF0800	\$9640.00	SKLL36BF0800	\$11557.00	SKPP36BF0800	\$13019.00			
1200	LIT	SKHH36BA1000	\$11624.00	SKLL36BA1000	\$14414.00	SKPP36BA1000	\$15410.00	TCAL125	\$76.00	(4) 250-350 Cu ³ (4) 250-500 Al
	LSIT	SKHH36BB1000	\$12989.00	SKLL36BB1000	\$15779.00	SKPP36BB1000	\$16775.00			
	LIGT ¹	SKHH36BC1000	\$12834.00	SKLL36BC1000	\$15624.00	SKPP36BC1000	\$16620.00			
	LSIGT ¹	SKHH36BD1000	\$14199.00	SKLL36BD1000	\$16989.00	SKPP36BD1000	\$17985.00			
	LIT-CP ²	SKHH36BE1000	\$11924.00	SKLL36BE1000	\$14714.00	SKPP36BE1000	\$15710.00			
	LSIT-CP ²	SKHH36BF1000	\$13289.00	SKLL36BF1000	\$16079.00	SKPP36BF1000	\$17075.00			
1200 ⁴	LIT	SKHH36BA1200	\$11624.00	SKLL36BA1200	\$14414.00	SKPP36BA1200	\$15410.00	TCAL125	\$76.00	(4) 250-350 Cu ³ (4) 250-500 Al
	LSIT	SKHH36BB1200	\$12989.00	SKLL36BB1200	\$15779.00	SKPP36BB1200	\$16775.00			
	LIGT ¹	SKHH36BC1200	\$12834.00	SKLL36BC1200	\$15624.00	SKPP36BC1200	\$16620.00			
	LSIGT ¹	SKHH36BD1200	\$14199.00	SKLL36BD1200	\$16989.00	SKPP36BD1200	\$17985.00			
	LIT-CP ²	SKHH36BE1200	\$11924.00	SKLL36BE1200	\$14714.00	SKPP36BE1200	\$15710.00			
	LSIT-CP ²	SKHH36BF1200	\$13289.00	SKLL36BF1200	\$16079.00	SKPP36BF1200	\$17075.00			

MicroVersaTrip Plus and PM Rating Plug Selection —

All Plugs List Price, \$106.00

GO-135S

SKHB, SKHH, SKLB, SKLL, SKPB, SKPP	800	300	SRPK800B300
		400	SRPK800B400
		500	SRPK800B500
		600	SRPK800B600
		700	SRPK800B700
		800	SRPK800B800
	1200	600	SRPK1200B600
		700	SRPK1200B700
		800	SRPK1200B800
		1000	SRPK1200B1000
		1200	SRPK1200B1200 ⁶

¹For grounded neutral systems (1**/3w or 3**4w) a neutral current sensor is required. Refer to page 3-109.

²For +24 Vdc Control Power Accessories refer to pages 3-106 to 3-109.

³Suitable for 500 kcmil copper, 1200A max. rating.

⁴100% UL rated SK1200 supplied with back-connected assembly which increases breaker depth. Refer to outline drawing 168D1678 Sh2 for details.

⁵For ground fault neutral current sensor, use 1200A rating.

⁶Not suitable for use with 100% rated, 1000A breaker frame.



MOLDED CASE
CIRCUIT BREAKERS

3

Industrial Circuit Breakers

300-1200A Circuit Breakers

Electronic Trip

Spectra RMS

SK1200 with MicroVersaTrip PM¹

MicroVersaTrip PM, Standard UL Rated (No Protective Relays)

SK1200 Line, Suitable for Reverse Feed, UL File E-11592, CSA LR 40350

3-Pole, UL/CSA: 1200A, 600 Vac Max., IEC 947-2: 1250A, 690 Vac Max. (SKL, SKP only)

Current Sensor	Trip Function	Frame						Terminal Lugs for Front connection (Cu/Al)		
		IC @480 Vac, UL 489		IC @480 Vac, UL 489		IC @480 Vac, UL 489		Product Number	List Price	Wire Range
		50kA Product Number	List Price	65kA Product Number	List Price	100kA Product Number	List Price			
800	LIT	SKHB36CA0800	\$5788.00	SKLB36CA0800	\$6752.00	SKPB36CA0800	\$9934.00	TCAL81	\$47.00	(3) 3/0-500 Cu (3) 3/0-500 Al
	LSIT	SKHB36CB0800	\$7153.00	SKLB36CB0800	\$8117.00	SKPB36CB0800	\$11299.00			
	LIGT ²	SKHB36CC0800	\$6998.00	SKLB36CC0800	\$7962.00	SKPB36CC0800	\$11144.00			
	LSIGT ²	SKHB36CD0800	\$8363.00	SKLB36CD0800	\$9327.00	SKPB36CD0800	\$12509.00			
1200	LIT	SKHB36CA1200	\$9277.00	SKLB36CA1200	\$10248.00	SKPB36CA1200	\$13054.00	TCAL125	\$76.00	(4) 250-350 Cu ³ (4) 250-500 Al
	LSIT	SKHB36CB1200	\$10642.00	SKLB36CB1200	\$11613.00	SKPB36CB1200	\$14419.00			
	LIGT ²	SKHB36CC1200	\$10487.00	SKLB36CC1200	\$11458.00	SKPB36CC1200	\$14264.00			
	LSIGT ²	SKHB36CD1200	\$11852.00	SKLB36CD1200	\$12823.00	SKPB36CD1200	\$15629.00			

MicroVersaTrip PM, 100% UL Rated (No Protective Relays)

SK1200 Line, Suitable for Reverse Feed, UL File E-11592, CSA LR 40350

3-Pole, UL/CSA: 1200A, 600 Vac Max., IEC 947-2: 1250A, 690 Vac Max. (SKL, SKP only)

Current Sensor	Trip Function	Frame						Terminal Lugs for Front connection (Cu/Al)		
		IC @480 Vac, UL 489		IC @480 Vac, UL 489		IC @480 Vac, UL 489		Product Number	List Price	Wire Range
		50kA Product Number	List Price	5kA Product Number	List Price	00kA Product Number	List Price			
800	LIT	SKHH36CA0800	\$9175.00	SKLL36CA0800	\$11092.00	SKPP36CA0800	\$12554.00	TCAL81	\$47.00	(3) 3/0-500 Cu (3) 3/0-500 Al
	LSIT	SKHH36CB0800	\$10540.00	SKLL36CB0800	\$12457.00	SKPP36CB0800	\$13919.00			
	LIGT ²	SKHH36CC0800	\$10385.00	SKLL36CC0800	\$12302.00	SKPP36CC0800	\$13764.00			
	LSIGT ²	SKHH36CD0800	\$11750.00	SKLL36CD0800	\$13667.00	SKPP36CD0800	\$15129.00			
1200 ⁴	LIT	SKHH36CA1000	\$12824.00	SKLL36CA1000	\$15614.00	SKPP36CA1000	\$16610.00	TCAL125	\$76.00	(4) 250-350Cu ⁴ (4) 250-500 Al
	LSIT	SKHH36CB1000	\$14189.00	SKLL36CB1000	\$16979.00	SKPP36CB1000	\$17975.00			
	LIGT ²	SKHH36CC1000	\$14034.00	SKLL36CC1000	\$16824.00	SKPP36CC1000	\$17820.00			
	LSIGT ²	SKHH36CD1000	\$15399.00	SKLL36CD1000	\$18189.00	SKPP36CD1000	\$19185.00			
1200 ⁵	LIT	SKHH36CA1200	\$12824.00	SKLL36CA1200	\$15614.00	SKPP36CA1200	\$16610.00	TCAL125	\$76.00	(4) 250-350Cu ⁴ (4) 250-500 Al
	LSIT	SKHH36CB1200	\$14189.00	SKLL36CB1200	\$16979.00	SKPP36CB1200	\$17975.00			
	LIGT ²	SKHH36CC1200	\$14034.00	SKLL36CC1200	\$16824.00	SKPP36CC1200	\$17820.00			
	LSIGT ²	SKHH36CD1200	\$15399.00	SKLL36CD1200	\$18189.00	SKPP36CD1200	\$19185.00			

MicroVersaTrip Plus and PM Rating Plug Selection —

All Plugs List Price, \$106.00

GO-135S

SKHB, SKHH, SKLB, SKLL, SKPB, SKPP	800	300	SRPK800B300
		400	SRPK800B400
		500	SRPK800B500
		600	SRPK800B600
		700	SRPK800B700
		800	SRPK800B800
	1200	600	SRPK1200B600
		700	SRPK1200B700
		800	SRPK1200B800
		1000	SRPK1200B1000
		1200	SRPK1200B1200 ⁶

¹MicroVersaTrip PM Trip Units require 24 Vdc control power and voltage sensing signals. Refer to pages 3-106 to 3-109.

²For grounded neutral systems (1**/3w or 3**/4w) a neutral current sensor is required. Refer to page 3-109.

³Suitable for 500 kcmil copper, 1200A max. rating.

⁴For ground fault neutral current sensor, use 1200A rating.

⁵100% UL rated SK1200 supplied with back-connected assembly which increases breaker depth. Refer to outline drawing 168D1678 Sh2 for details.

⁶Not suitable for use with 100% rated, 1000A breaker frame.

Publications and Reference: See Section 21 for a list of additional product-related publications



Industrial Circuit Breakers

300-1200A Circuit Breakers

Electronic Trip

Spectra RMS

SK1200 with MicroVersaTrip Plus and PM¹

MicroVersaTrip PM, Standard UL Rated (With Protective Relaying)

SK1200 Line, Suitable for Reverse Feed, UL File E-11592, CSA LR 40350

3-Pole, UL/CSA: 1200A, 600 Vac Max., IEC 947-2: 1250A, 690 Vac Max. (SKL, SKP only)

		Frame						Terminal Lugs for Front connection (Cu/Al)		
		IC @480 Vac, UL 489		IC @480 Vac, UL 489		IC @480 Vac, UL 489				
Current Sensor	Trip Function	50kA Product Number	List Price, GO-135PM	65kA Product Number	List Price, GO-135PM	100kA Product Number	List Price, GO-135PM	Product Number	List Price, GO-135S	Wire Range
800	LIT	SKHB36DA0800	\$6988.00	SKLB36DA0800	\$7952.00	SKPB36DA0800	\$11134.00	TCAL81	\$47.00	(3) 3/0-500 Cu (3) 3/0-500 Al
	LSIT	SKHB36DB0800	\$8353.00	SKLB36DB0800	\$9317.00	SKPB36DB0800	\$12499.00			
	LIGT ²	SKHB36DC0800	\$8198.00	SKLB36DC0800	\$9162.00	SKPB36DC0800	\$12344.00			
	LSIGT ²	SKHB36DD0800	\$9563.00	SKLB36DD0800	\$10527.00	SKPB36DD0800	\$13709.00			
1200	LIT	SKHB36DA1200	\$10477.00	SKLB36DA1200	\$11448.00	SKPB36DA1200	\$14254.00	TCAL125	\$76.00	(4) 250-350 Cu ³ (4) 250-500 Al
	LSIT	SKHB36DB1200	\$11842.00	SKLB36DB1200	\$12813.00	SKPB36DB1200	\$15619.00			
	LIGT ²	SKHB36DC1200	\$11687.00	SKLB36DC1200	\$12658.00	SKPB36DC1200	\$15464.00			
	LSIGT ²	SKHB36DD1200	\$13052.00	SKLB36DD1200	\$14023.00	SKPB36DD1200	\$16829.00			

MicroVersaTrip PM, 100% UL Rated (With Protective Relays)

SK1200 Line, Suitable for Reverse Feed, UL File E-11592, CSA LR 40350

3-Pole, UL/CSA: 1200A, 600 Vac Max., IEC 947-2: 1250A, 690 Vac Max. (SKL, SKP only)

		Frame						Terminal Lugs for Front connection (Cu/Al)		
		IC @480 Vac, UL 489		IC @480 Vac, UL 489		IC @480 Vac, UL 489				
Current Sensor	Trip Function	50kA Product Number	List Price, GO-135PM	65kA Product Number	List Price, GO-135PM	100kA Product Number	List Price, GO-135PM	Product Number	List Price, GO-135S	Wire Range
800	LIT	SKHH36DA0800	\$10375.00	SKLL36DA0800	\$12292.00	SKPP36DA0800	\$13754.00	TCAL81	\$47.00	(3) 3/0-500 Cu (3) 3/0-500 Al
	LSIT	SKHH36DB0800	\$11740.00	SKLL36DB0800	\$13657.00	SKPP36DB0800	\$15119.00			
	LIGT ²	SKHH36DC0800	\$11585.00	SKLL36DC0800	\$13502.00	SKPP36DC0800	\$14964.00			
	LSIGT ²	SKHH36DD0800	\$12950.00	SKLL36DD0800	\$14867.00	SKPP36DD0800	\$16329.00			
1200 ⁴	LIT	SKHH36DA1000	\$14024.00	SKLL36DA1000	\$16814.00	SKPP36DA1000	\$17810.00	TCAL125	\$76.00	(4) 250-350 Cu ³ (4) 250-500 Al
	LSIT	SKHH36DB1000	\$15389.00	SKLL36DB1000	\$18179.00	SKPP36DB1000	\$19175.00			
	LIGT ²	SKHH36DC1000	\$15234.00	SKLL36DC1000	\$18024.00	SKPP36DC1000	\$19020.00			
	LSIGT ²	SKHH36DD1000	\$16599.00	SKLL36DD1000	\$19389.00	SKPP36DD1000	\$20385.00			
1200 ⁵	LIT	SKHH36DA1200	\$14024.00	SKLL36DA1200	\$16814.00	SKPP36DA1200	\$17810.00	TCAL125	\$76.00	(4) 250-350 Cu ³ (4) 250-500 Al
	LSIT	SKHH36DB1200	\$15389.00	SKLL36DB1200	\$18179.00	SKPP36DB1200	\$19175.00			
	LIGT ²	SKHH36DC1200	\$15234.00	SKLL36DC1200	\$18024.00	SKPP36DC1200	\$19020.00			
	LSIGT ²	SKHH36DD1200	\$16599.00	SKLL36DD1200	\$19389.00	SKPP36DD1200	\$20385.00			

MicroVersaTrip Plus and PM Rating Plug Selection —

All Plugs List Price, \$106.00

GO-135S

SKHB, SKHH, SKLB, SKLL, SKPB, SKPP	800	300	SRPK800B300
		400	SRPK800B400
		500	SRPK800B500
		600	SRPK800B600
		700	SRPK800B700
		800	SRPK800B800
	1200	600	SRPK1200B600
		700	SRPK1200B700
		800	SRPK1200B800
		1000	SRPK1200B1000
		1200	SRPK1200B1200 ⁶

¹MicroVersaTrip PM Trip Units require 24 Vdc control power and voltage sensing signals. Refer to pages 3-106 to 3-109.

²For grounded neutral systems (1**/3w or 3**4w) a neutral current sensor is required. Refer to page 3-109.

³Suitable for 500 kcmil copper, 1200A max. rating.

⁴For ground fault neutral current sensor, use 1200A rating.

⁵100% UL rated SK1200 supplied with back-connected assembly which increases breaker depth. Refer to outline drawing 168D1678 Sh2 for details.

⁶Not suitable for use with 100% rated, 1000A breaker frame.



Industrial Circuit Breakers

300-1200A Circuit Breakers

Thermal-Magnetic Trip

K1200 Line Circuit Breakers

Types TKM, THMK

Types TKM, THKM — Interchangeable Trip, not suitable for reverse feed

GO-135B

Complete Circuit Breaker Includes Line and Load Lugs							Terminal Lugs for Front Connection (Cu/Al) ¹						
Adjustable Instantaneous							Frame Only Product Number	List Price	Trip Unit Only. Use with Standard and Hi-Break Frames	List Price	Product Number		
Ampere Rating	Trip Ampere Range Low High		Standard Product Number	List Price	Hi-Break ¹ Product Number	List Price					(Order 2 per pole)	List Price	Wire Size
800A Frame—Two-Pole													
300	900	3000	TKMA826300WL	\$3672.00	THKMA826300WL	\$4579.00	TKM826F000 Standard Frame	\$1244.00	TKMA836T300	\$2268.00	TCAL61	\$40.00	(2) 2/0-500 Cu/Al
350	1050	3500	TKMA826350WL	\$3672.00	THKMA826350WL	\$4579.00			TKMA836T350	\$2268.00			
400	1200	4000	TKMA826400WL	\$3672.00	THKMA826400WL	\$4579.00			TKMA836T400	\$2268.00			
450	1350	4500	TKMA826450WL	\$3672.00	THKMA826450WL	\$4579.00			TKMA836T450	\$2268.00			
500	1500	5000	TKMA826500WL	\$3672.00	THKMA826500WL	\$4579.00			TKMA836T500	\$2268.00			
600	1800	6000	TKMA826600WL	\$3672.00	THKMA826600WL	\$4579.00			TKMA836T600	\$2268.00			
700	2100	6400	TKMA826700WL	\$3700.00	THKMA826700WL	\$4611.00	THKM826F000 Hi-Break Frame	\$2167.00	TKMA836T700	\$2268.00	TCAL81	\$47.00 ²	(3) 3/0-500 Cu/Al
800	2400	6400	TKMA826800WL	\$3700.00	THKMA826800WL	\$4611.00			TKMA836T800	\$2268.00			
800A Frame—Three-Pole													
300	900	3000	TKMA836300WL	\$4713.00	THKMA836300WL	\$5624.00	TKM836F000 Standard Frame	\$2205.00	TKMA836T300	\$2268.00	TCAL61	\$40.00	(2) 2/0-500 Cu/Al
350	1050	3500	TKMA836350WL	\$4713.00	THKMA836350WL	\$5624.00			TKMA836T350	\$2268.00			
400	1200	4000	TKMA836400WL	\$4713.00	THKMA836400WL	\$5624.00			TKMA836T400	\$2268.00			
450	1350	4500	TKMA836450WL	\$4713.00	THKMA836450WL	\$5624.00			TKMA836T450	\$2268.00			
500	1500	5000	TKMA836500WL	\$4713.00	THKMA836500WL	\$5624.00			TKMA836T500	\$2268.00			
600	1800	6000	TKMA836600WL	\$4713.00	THKMA836600WL	\$5624.00			TKMA836T600	\$2268.00			
700	2100	6400	TKMA836700WL	\$4755.00	THKMA836700WL	\$5666.00	THKM836F000 Hi-Break Frame	\$3116.00	TKMA836T700	\$2268.00	TCAL81	\$47.00 ⁴	(3) 3/0-500 Cu/Al
800	2400	6400	TKMA836800WL	\$4755.00	THKMA836800WL	\$5666.00			TKMA836T800	\$2268.00			
800	1200	4000	—	—	—	—			TKMA836TM48 ³	\$2268.00			
Mag Only	2400	8000	—	—	—	—	TKMA836TM68 ³	\$2268.00					

¹For optional lugs, see page 3-101.

²Not UL listed.

³Internal accessory installation requires dummy trip unit. See page 3-91 for additional details. Nonautomatic trip unit and dummy trip unit not UL listed for field installation.

⁴GO-135S.



Industrial Circuit Breakers

300-1200A Circuit Breakers

Thermal-Magnetic Trip

K1200 Line Circuit Breakers

Types TKM, THMK

Types TKM, THKM — Interchangeable Trip, not suitable for reverse feed

GO-135B

Adjustable Instantaneous Trip Ampere Range							Complete Circuit Breaker Includes Line and Load Lugs				Terminal Lugs for Front Connection (Cu/Al) ¹		
Ampere Rating	Low	High	Standard Product Number	List Price	Hi-Break ¹ Product Number	List Price	Frame Only Product Number	List Price	Trip Unit Only. Use with Standard and Hi-Break Frames	List Price	Product Number (Order 2 per pole)	List Price	Wire Size
1200 Frame — Two-Pole													
600	1800	6000	TKMA20600WL	\$5172.00	THKMA20600WL	\$6069.00	TKM2F		TKMA3T0600	\$2294.00	TCAL81	\$47.00 ²	(3) 3/0-500
700	2100	6400	TKMA20700WL	\$5172.00	THKMA20700WL	\$6069.00	Standard	\$2690.00	TKMA3T0700	\$2294.00			Cu/Al
800	2400	6400	TKMA20800WL	\$5172.00	THKMA20800WL	\$6069.00	Frame		TKMA3T0800	\$2294.00			
1000	3000	10000	TKMA21000WL ³	\$5472.00	THKMA21000WL ³	\$6353.00			TKMA3T1000 ⁴	\$2478.00			(4) 250-350 ⁵
1200	3600	10000	TKMA21200WL ³	\$7471.00	THKMA21200WL ³	\$8368.00			TKMA3T1200 ⁴	\$4477.00	TCAL121	\$76.00 ²	Cu or (4) 300-500 Al
1200 Frame — Three-Pole													
600	1800	6000	TKMA30600WL	\$5885.00	THKMA30600WL	\$6795.00			TKMA3T0600	\$2294.00	TCAL81	\$47.00 ²	(3) 3/0-500
700	2100	6400	TKMA30700WL	\$5885.00	THKMA30700WL	\$6795.00			TKMA3T0700	\$2294.00			Cu/Al
800	2400	6400	TKMA30800WL	\$5885.00	THKMA30800WL	\$6795.00	TKM3F	\$3309.00	TKMA3T0800	\$2294.00			
1000	3000	10000	TKMA31000WL ⁴	\$6243.00	THKMA31000WL ⁴	\$7153.00	Standard		TKMA3T1000 ⁴	\$2478.00			
1200	3600	10000	TKMA31200WL ⁴	\$8242.00	THKMA31200WL ⁴	\$9152.00	Frame		TKMA3T1200 ⁴	\$4477.00			(4) 250-350 ⁵
Mag Only	1800	6000	—	—	—	—	THKM2F	\$4219.00	TKMA3TM512 ³	\$4477.00	TCAL121	\$76.00 ²	Cu or (4) 300-500 Al
	2400	8000	—	—	—	—	Hi-Break Frame		TKMA3TM612 ³	\$4477.00			

¹For optional lugs, see page 3-101.

²GO-135S.

³Not UL listed.

⁴Not Suitable for use on dc systems.

⁵Suitable for 500 kcmil Cu for voltage drop considerations.

Accessories: See pages 3-85 to 3-104.

MOLDED CASE CIRCUIT BREAKERS

3



Industrial Circuit Breakers

400-2000A Circuit Breakers

Electronic Trip

R Frame Circuit Breaker Frames

- R-Frame Molded Case Circuit Breaker Frames
- 600 Vac, 50/60 Hz, 3-Poles only. Suitable for Reverse Feed
- Complete breaker requires frame and rating plug.
- For 4-wire GF application, select neutral CT from page 3-105, order separately.
- IC Ratings shown are at 480 Vac.

Circuit Breaker Frame Selection

MicroVersaTrip Plus Trip Units

GO-135S

Current Sensor	Trip Function	Standard Rating		100% Rating			
		Product Number	List Price	Product Number	List Price		
1000 A	LIT	TRLA36BA10	\$10610.00	TRLL36BA10	\$13871.00		
		LSIT	TRLA36BB10	\$11975.00	TRLL36BB10	\$15236.00	
		LIGT	TRLA36BC10	\$11820.00	TRLL36BC10	\$15081.00	
		LSIGT	TRLA36BD10	\$13185.00	TRLL36BD10	\$16446.00	
		LIGTZ1	TRLA36BE10	\$12405.00	TRLL36BE10	\$15666.00	
		LSIGTZ1	TRLA36BF10	\$13770.00	TRLL36BF10	\$17031.00	
	1600 A	LIT	TRLA36BA16	\$10610.00	TRLL36BA16	\$13871.00	
			LSIT	TRLA36BB16	\$11975.00	TRLL36BB16	\$15236.00
			LIGT	TRLA36BC16	\$11820.00	TRLL36BC16	\$15081.00
			LSIGT	TRLA36BD16	\$13185.00	TRLL36BD16	\$16446.00
			LIGTZ1	TRLA36BE16	\$12405.00	TRLL36BE16	\$15666.00
			LSIGTZ1	TRLA36BF16	\$13770.00	TRLL36BF16	\$17031.00
2000 A	LIT	TRLA36BA20	\$11488.00	TRLL36BA20	\$14986.00		
		LSIT	TRLA36BB20	\$12853.00	TRLL36BB20	\$16351.00	
		LIGT	TRLA36BC20	\$12698.00	TRLL36BC20	\$16196.00	
		LSIGT	TRLA36BD20	\$14063.00	TRLL36BD20	\$17561.00	
		LIGTZ1	TRLA36BE20	\$13283.00	TRLL36BE20	\$16781.00	
		LSIGTZ1	TRLA36BF20	\$14648.00	TRLL36BF20	\$18146.00	
	2000 A	LIT	TRLA36BA20	\$11488.00	TRLL36BA20	\$14986.00	
			LSIT	TRLA36BB20	\$12853.00	TRLL36BB20	\$16351.00
			LIGT	TRLA36BC20	\$12698.00	TRLL36BC20	\$16196.00
			LSIGT	TRLA36BD20	\$14063.00	TRLL36BD20	\$17561.00
			LIGTZ1	TRLA36BE20	\$13283.00	TRLL36BE20	\$16781.00
			LSIGTZ1	TRLA36BF20	\$14648.00	TRLL36BF20	\$18146.00

R-Frame Current Sensors and Rating Plugs

GO-245A

Sensor	Current Rating	Rating Plug Product Number	List Price
1000 A	400 A	TR10B400	\$89.00
	600 A	TR10B600	\$89.00
	800 A	TR10B800	\$89.00
	1000A	TR10B1000	\$89.00
1600 A	600 A	TR16B600	\$89.00
	800 A	TR16B800	\$89.00
	1000 A	TR16B1000	\$89.00
	1100 A	TR16B1100	\$89.00
2000 A	1200 A	TR16B1200	\$89.00
	1600 A	TR16B1600	\$89.00
	750 A	TR20B750	\$89.00
	800 A	TR20B800	\$89.00
2000 A	1000 A	TR20B1000	\$89.00
	1200 A	TR20B1200	\$89.00
	1500 A	TR20B1500	\$89.00
	1600 A	TR20B1600	\$89.00
	2000 A	TR20B2000	\$89.00
Rating Plug Removal Tool		TRTOOL	\$12.00 ¹

¹GO-135S.

Current Sensor	Trip Function	Standard Rating		100% Rating			
		Product Number	List Price	Product Number	List Price		
1000 A	LIT	TRPA36BA10	\$12465.00	TRPP36BA10	\$16258.00		
		LSIT	TRPA36BB10	\$13830.00	TRPP36BB10	\$17623.00	
		LIGT	TRPA36BC10	\$13675.00	TRPP36BC10	\$17468.00	
		LSIGT	TRPA36BD10	\$15040.00	TRPP36BD10	\$18833.00	
		LIGTZ1	TRPA36BE10	\$14260.00	TRPP36BE10	\$18053.00	
		LSIGTZ1	TRPA36BF10	\$15625.00	TRPP36BF10	\$19418.00	
	1600 A	LIT	TRPA36BA16	\$12465.00	TRPP36BA16	\$16258.00	
			LSIT	TRPA36BB16	\$13830.00	TRPP36BB16	\$17623.00
			LIGT	TRPA36BC16	\$13675.00	TRPP36BC16	\$17468.00
			LSIGT	TRPA36BD16	\$15040.00	TRPP36BD16	\$18833.00
			LIGTZ1	TRPA36BE16	\$14260.00	TRPP36BE16	\$18053.00
			LSIGTZ1	TRPA36BF16	\$15625.00	TRPP36BF16	\$19418.00
2000 A	LIT	TRPA36BA20	\$13472.00	TRPP36BA20	\$17566.00		
		LSIT	TRPA36BB20	\$14837.00	TRPP36BB20	\$18931.00	
		LIGT	TRPA36BC20	\$14682.00	TRPP36BC20	\$18776.00	
		LSIGT	TRPA36BD20	\$16047.00	TRPP36BD20	\$20141.00	
		LIGTZ1	TRPA36BE20	\$15267.00	TRPP36BE20	\$19361.00	
		LSIGTZ1	TRPA36BF20	\$16632.00	TRPP36BF20	\$20726.00	
		TRPA36BG20	\$17217.00	TRPP36BG20	\$21311.00		

www.DataSheet4U.com

Publications and Reference: See Section 21 for a list of additional product-related publications



www.DataSheet4U.com

MOLDED CASE CIRCUIT BREAKERS 3

Molded Case Switches

150-1200A
Spectra RMS

Molded Case Switches

GO-135S

UL File E-57546, CSA LR 91464

Includes fixed, high-set Instantaneous trip suitable for reverse feed.

Frame Type	Ampere Rating	Switch ¹		Terminal Lugs for Front Connection (Cu/Al)		Wire Range	Maximum Short Circuit Withstand Rating ² (kA rms symmetrical)		
		Product Number	List Price	Product Number	List Price		240 Vac	480 Vac	600 Vac
SE150	100	SEDA36AN0100	\$650.00	TCAL18	\$3.00	Aluminum: #12-3/0 Copper: #14-3/0	200	100	25
	150	SEDA36AN0150	\$948.00						
SF250	250	SFDA36AN0250	\$1126.00	TCAL29	\$8.00	Aluminum: #8-350 kcmil Copper: #8-350 kcmil	200	100	25
	400	SGDA36AN0400	\$1813.00	3-pole lug kit					
SG600	600	SGDA36AN0600	\$2489.00	TCLK365 ³	\$42.00	Aluminum: (2) 2/0-500 kcmil or (1) #6-600 kcmil Copper: (2) 2/0-500 kcmil or (1) #8-600 kcmil	200	100	42
	800	SKDA36AN0800	\$2483.00	TCAL81	\$47.00				
SK1200	1000	SKDA36AN1000	\$3600.00	TCAL125	\$76.00	Aluminum: (3) 3/0-500 kcmil Copper: (3) 3/0-500 kcmil	100	65	42
	1200	SKDA36AN1200	\$3600.00						

¹No rating plug required.

²The maximum withstand rating is limited by the application to the value set forth in this table or the short circuit rating of the upstream fuse or circuit breaker, whichever is less. The upstream protective device must have an instantaneous trip function or element and its rated ampacity may not exceed the ampere rating of the switch.

³Order one kit for either line or load end; two kits required for both.

⁴Suitable for 500 kcmil copper, 1200A max. rating.

Noninterchangeable Trip, Includes Cu/Al load lugs. For optional lugs, see page 3-101 and 3-102.

GO-135B

Type	Ampere Rating	Number of Poles	Voltage Rating	Product Number	List Price
TEB	100	1	120 Vac, 125 Vdc	TEB111Y100 ⁵	\$65.50
TEB	100	2	240 Vac, 250 Vdc	TEB122Y100 ⁵	\$159.00
TEB	100	3	240 Vac	TEB132Y100 ⁵	\$240.00
TED	100	1	277 Vac, 125 Vdc	TED113Y100 ⁵	\$82.50
TED	100	2	480 Vac, 250 Vdc	TED124Y100 ⁵	\$263.00
TED	150	2	480 Vac, 250 Vdc	TED124Y150 ^{5,6}	\$708.00
TFJ	225	2	480 Vac	TFJ226Y225 ^{5,7}	\$803.00
TFJ	225	3	600 Vac	TFJ236Y225	\$1174.00
TJJ	400	2	600 Vac, 250 Vdc	TJJ426Y400 ⁸	\$1577.00
TJJ	400	2	600 Vac	TJJ436Y400 ⁸	\$1904.00

Interchangeable Trip, Includes Cu/Al load lugs. For optional lugs, see page 3-101 and 3-102.

GO-135B

Type	Ampere Rating	Number of Poles	Voltage Rating	Product Number	List Price
TFK	225	2	480 Vac, 250 Vdc	TFK226Y225 ^{7,8,9}	\$937.00
TFK	225	3	600 Vac, 250 Vdc	TFK236Y225 ^{8,9}	\$1174.00
TJK	400	2	600 Vac, 250 Vdc	TJK426Y400 ⁸	\$1874.00
TJK	400	3	600 Vac, 250 Vdc	TJK436Y400 ⁸	\$2330.00
TJK	600	2	600 Vac, 250 Vdc	TJK626Y600 ⁸	\$1844.00
TJK	600	3	600 Vac, 250 Vdc	TJK636Y600 ⁸	\$2595.00
TMK	800	2	600 Vac, 250 Vdc	TMKA836Y800 ⁸	\$1692.00
TMK	800	3	600 Vac, 250 Vdc	TMKA826Y800 ⁸	\$2769.00
TMK	1000	2	600 Vac, 250 Vdc	TMKA2Y1000 ⁸	\$3311.00
TMK	1000	3	600 Vac, 250 Vdc	TMKA3Y1000 ⁸	\$4030.00
TMK	1200	2	600 Vac, 250 Vdc	TMKA2Y1200 ⁸	\$3420.00
TMK	1200	3	600 Vac, 250 Vdc	TMKA3Y1200 ⁸	\$4191.00

⁵Internal accessory requires factory installed dummy trip. Specify on order. Accessories not available for one-pole TEB, TED.

⁶Not UL listed.

⁷600 Volts max.

⁸Internal accessory requires factory installed dummy trip unit. See page 3-91 for additional details. Nonautomatic trip unit and dummy trip not UL listed for field installation.

⁹UL listed only when ordered as a complete switch.



MOLDED CASE CIRCUIT BREAKERS

3

Motor Circuit Protectors

3-1200A

Spectra RMS

Spectra RMS Mag-Break Motor Circuit Protectors
Current Limiting, UL Component Recognized¹

Features

- Suitable for Reverse Feed
- UL Recognized File E-11592
- CSA Certified LR 40350
- IEC 947-2 690 Vac Max.
 - SE 150 160 Ampere Max.
 - SF250 250 Ampere Max.
 - SG600 630 Ampere Max.
 - SK1200 1250 Ampere Max.
- UL Current Limiting

High Interrupting Capacity Spectra RMS Motor Circuit Protectors

Rating Plug				Frame				Terminal Lugs for Front Connection (Cu/Al)				
Ampere Rating	Adjustable Instantaneous Trip Ampere Range		Product Number	List Price, GO-135S	Current Sensor	65kAIC @480 Vac		100kAIC @480 Vac		Product Number	List Price, GO-135S	Wire Range
	Low	High				Product Number	List Price, GO-141S	Product Number	List Price, GO-141S			
SE150 Line 3-Pole												
3	11	39	SRPE7A3	\$106.00	7	SELA36AI0007	\$530.00	SEPA36AI0007	\$663.00	TCAL18	\$3.00	14-3/0 Cu
7	22	90	SRPE7A7	\$106.00								
15	43	182	SRPE30A15	\$106.00								
20	58	254	SRPE30A20	\$106.00								
25	73	332	SRPE30A25	\$106.00	30	SELA36AI0030	\$530.00	SEPA36AI0030	\$663.00	TCAL18	\$3.00	12-3/0 Al
30	87	415	SRPE30A30	\$106.00								
40	118	501	SRPE60A40	\$106.00								
50	148	637	SRPE60A50	\$106.00								
60	178	777	SRPE60A60	\$106.00	60	SELA36AI0060	\$686.00	SEPA36AI0060	\$858.00	TCAL18	\$3.00	12-3/0 Al
70	206	863	SRPE100A70	\$106.00								
80	236	999	SRPE100A80	\$106.00								
90	267	1138	SRPE100A90	\$106.00								
100	297	1280	SRPE100A100	\$106.00	100	SELA36AI0100	\$754.00	SEPA36AI0100	\$943.00	TCAL18	\$3.00	12-3/0 Al
110	328	1426	SRPE150A110	\$106.00								
125	374	1640	SRPE150A125	\$106.00								
150	450	1991	SRPE150A150	\$106.00								
150	450	1991	SRPE150A150	\$106.00	150	SELA36AI0150	\$848.00	SEPA36AI0150	\$1060.00	TCAL18	\$3.00	12-3/0 Al

Standard Capacity Mag-Break Motor Circuit Protectors—Adjustable Magnetic Trip, Noninterchangeable Types TEC, TECL GO-141

Complete Breaker (includes line and load lugs)

Ampere Rating	Adjustable Trip Ampere Range ²		Two-Pole, 480 Vac ³		Three-Pole, 600 Vac		Add-on Limiter Three-Pole, 100 kAIC	
	Low	High	Product Number	List Price	Product Number	List Price	Product Number	List Price
3	8	38	TEC24003	\$318.00	TEC36003	\$388.00	TECL36003	\$231.00
7	18	90	TEC24007	\$318.00	TEC36007	\$388.00	TECL36007	\$231.00
15	42	198	TEC24015	\$318.00	TEC36015	\$388.00	TECL36015	\$231.00
30	90	390	TEC24030	\$318.00	TEC36030	\$388.00	TECL36030	\$231.00
50	180	660	TEC24050	\$377.00	TEC36050	\$464.00	TECL36050	\$231.00
100	300	1300	TEC24100	\$413.00	TEC36100	\$498.00	TECL36100	\$524.00
150	600	2700	TEC24150	\$477.00	TEC36150	\$545.00	TECL36150	\$1079.00

¹Per UL 489, interrupting capacities are not shown on product label.

²AC only

³Two-pole furnished in three-pole case.

www.DataSheet4U.com

Publications and Reference: See Section 31 for a list of additional product-related publications



www.DataSheet4U.com

Motor Circuit Protectors

150-1200A

Spectra RMS

Spectra RMS Mag-Break Motor Circuit Protectors

Current Limiting, UL Component Recognized¹

SF250 Line 3-Pole

Rating Plug				Frame				Terminal Lugs for Front Connection (Cu/Al)				
Ampere Rating	Adjustable Instantaneous Trip Ampere Range		Product Number	List Price, GO-135S	Current Sensor	65kAIC @480 Vac		100kAIC @480 Vac		Product Number	List Price, GO-135S	Wire Range
	Low	High				Product Number	List Price, GO-141S	Product Number	List Price, GO-141S			
SE150 Line 3-Pole												
70	205	700	SRPF250A70	\$106.00	250	SFLA36AI0250	\$1297.00	SFPA36AI0250	\$1622.00	TCAL29	\$8.00	8-350 Cu 8-350 Al
90	265	900	SRPF250A90	\$106.00								
100	295	1000	SRPF250A100	\$106.00								
110	325	1100	SRPF250A110	\$106.00								
125	370	1250	SRPF250A125	\$106.00								
150	440	1500	SRPF250A150	\$106.00								
175	515	1750	SRPF250A175	\$106.00								
200	590	2000	SRPF250A200	\$106.00								
225	665	2250	SRPF250A225	\$106.00								
250	736	2500	SRPF250A250	\$106.00								

Types TFC, TJC, TKC 3-Pole

GO-135B

Ampere Rating	Adjustable Instantaneous Trip Ampere Range		Complete Breaker (includes line and load lugs)	
	Low	High	Product Number	List Price
225	600	1400	TFC36225	\$1448.00
	100	2250	TFC36225A	\$1448.00
400	330	1100	TJC36400E	\$2589.00
	550	1670	TJC36400F	\$2589.00
	1000	3300	TJC36400G	\$2589.00
	1200	4000	TJC36400B	\$2589.00
600	1000	3300	TJC36600G	\$3676.00
	1800	6000	TJC36600H	\$3676.00
800	3000	6000	TKC36800L ²	\$4880.00
	5000	10000	TKC36800M ²	\$4880.00
1200	3000	6000	TKC361200L ²	\$8412.00
1200	5000	10000	TKC361200M ²	\$8412.00

Type TBC with Current Limiters

GO-135B

Complete Breaker (includes line and load lugs)						
Ampere Rating	Adjustable Instantaneous Trip Ampere Range		Product Number	List Price	Standard Replacement Current Limiters	
	Low	High			Product Number	List Price
225	550	1670	TBC43225F14F	\$3810.00	TB10F14	\$377.00
400	1000	3300	TBC43400F14G	\$5149.00	TB10F14	\$377.00
600	3000	6000	TBC63600J14L	\$7443.00	TB10BJ14	\$543.00
800	2400	6000	TBC83800K22 ²	\$8622.00	TB15K22	\$543.00

¹Per UL 489, interrupting capacities are not shown on product label.

²Balanced three-phase inrush current will trip the circuit breaker at lower than indicated currents.

For motors over 350 hp, use Spectra RMS SK frame or circuit breakers with MicroVersaTrip Plus Trip Units

Accessories: See pages 3-83 to 3-104.

www.DataSheet4U.com



MOLDED CASE CIRCUIT BREAKERS 3

Motor Circuit Protectors

150-1200A

Spectra RMS

Spectra RMS Mag-Break Motor Circuit Protectors

Current Limiting, UL Component Recognized¹

SG 600 Line 3-Pole

Rating Plug				Frame				Terminal Lugs for Front Connection (Cu/Al)					
Ampere Rating	Adjustable Instantaneous Trip Ampere Range		Product Number	List Price, GO-135S	Current Sensor	65kAIC @480 Vac		Product Number	List Price, GO-141S	Product Number	List Price, GO-135S	Wire Range	
	Low	High				Product Number	List Price, GO-141S						
400 Ampere Max.													
125	380	1275	SRPG400A125	\$106.00	400	SGLA36AI0400	\$2396.00	SGPA36AI0400	\$2995.00	3-Pole lug kit	TCLK365 ²	\$42.00	(2) 2/0-500 Cu or (1) 8-600 Cu
150	455	1530	SRPG400A150	\$106.00									
175	530	1785	SRPG400A175	\$106.00									
200	605	2040	SRPG400A200	\$106.00									
225	680	2295	SRPG400A225	\$106.00									
250	755	2550	SRPG400A250	\$106.00									
300	905	3060	SRPG400A300	\$106.00									
350	1060	3570	SRPG400A350	\$106.00									
400	1210	4080	SRPG400A400	\$106.00									
600 Ampere Max.													
250	765	2530	SRPG600A250	\$106.00	600	SGLA36AI0600	\$3481.00	SGPA36AI0600	\$4350.00	3-Pole lug kit	TCLK365 ²	\$42.00	(2) 2/0-500 Cu or (1) 8-600 Cu
300	915	3035	SRPG600A300	\$106.00									
350	1070	3545	SRPG600A350	\$106.00									
400	1220	4050	SRPG600A400	\$106.00									
450	1375	4555	SRPG600A450	\$106.00									
500	1525	5060	SRPG600A500	\$106.00									
600	1830	6075	SRPG600A600	\$106.00									

SK1200 Line (Not Current Limiting) 3-Pole

Rating Plug				Frame				Terminal Lugs for Front Connection (Cu/Al)					
Ampere Rating	Adjustable Instantaneous Trip Ampere Range		Product Number	List Price, GO-135S	Current Sensor	65kAIC @480 Vac		Product Number	List Price, GO-141S	Product Number	List Price, GO-135S	Wire Range	
	Low	High				Product Number	List Price, GO-141S						
800 Ampere Max.													
300	940	3015	SRPK800A300	\$106.00	800	SKLA36AI0800	\$4490.00	TCAL81	\$47.00	3-Pole lug kit	TCAL81	\$47.00	(3) 3/0-500 Cu
400	1250	4015	SRPK800A400	\$106.00									
500	1570	5020	SRPK800A500	\$106.00									
600	1875	6195	SRPK800A600	\$106.00									
700	2155	7420	SRPK800A700	\$106.00									
800	2440	8705	SRPK800A800	\$106.00									
1200 Ampere Max.													
600	1825	6110	SRPK1200A600	\$106.00	1200	SKLA36AI1200	\$7859.00	TCAL125	\$76.00	3-Pole lug kit	TCAL125	\$76.00	(4) 250-500 Cu ³ or (4) 250-350 Al
700	2125	7125	SRPK1200A700	\$106.00									
800	2430	8145	SRPK1200A800	\$106.00									
1000	3040	10180	SRPK1200A1000	\$106.00									
1200	3650	12215	SRPK1200A1200	\$106.00									

¹Per UL 489, interrupting capacities are not shown on product label.

²Order one kit for either the line or load end; two kits required for both.

³Suitable for 500 kcmil copper, 1200A max. rating.



MOLDED CASE CIRCUIT BREAKERS

3

Special Purpose

Mine Duty Breakers

Mine Duty Circuit Breakers

Standard Duty

50-1200 amperes

600 Vac

300 Vdc

Three-Pole 1000 Wye 577 Vac (Not UL Listed) — Without Line or Load Lugs¹

GO-135A

Ampere Rating	Complete Breaker						Frame Only		Trip Unit Only			
	Thermal Magnetic			Magnetic Only			Product Number	List Price	Thermal Magnetic		Magnetic Only	
	Magnetic Instantaneous Trip Low	Magnetic Instantaneous Trip High	Product Number	List Price	Product Number	List Price			Product Number	List Price	Product Number	List Price
E Frame — 100 Amperes Maximum, Noninterchangeable Trip												
50	50 ²	180 ²	TE131050MD	\$1104.00	TE131M050MD	\$1104.00	—	—	—	—	—	—
100	100 ²	500 ²	TE131100MD	\$1104.00	TE131M100MD	\$1104.00	—	—	—	—	—	—
J Frame — 225 Amperes Maximum, Interchangeable Trip³												
225	300	1000	TJ132225MD1	—	TJ132M2MD1	—	TJ132FMD	\$3231.00	TJ32225TMD1	\$920.00	TJ32M2TMD1	\$920.00
225	500	1500	TJ132225MD2	—	TJ132M2MD2	—	—	—	TJ32225TMD2	\$920.00	TJ32M2TMD2	\$920.00
J Frame — 400 Amperes Maximum, Interchangeable Trip³												
400	500	1500	TJ134400MD2	—	TJ134M4MD2	—	TJ134FMD	\$4499.00	TJ34400TMD2	\$1007.00	TJ34M4TMD2	\$1007.00
400	900	3000	TJ134400MD3	—	TJ134M4MD3	—	—	—	TJ34400TMD3	\$1007.00	TJ34M4TMD3	\$1007.00
J Frame — 600 Amperes Maximum, Interchangeable Trip³												
600	900	3000	TJ136600MD3	—	TJ136M6MD3	—	TJ136FMD	\$4636.00	TJ36600TMD3	\$1071.00	TJ36M6TMD3	\$1671.00
K Frame — 800 Amperes Maximum, Interchangeable Trip³												
300	900	3000	TK138600MD3	—	—	—	—	—	TK38300TMD3	\$1815.00	—	—
400	1250	3000	TK138400MD4	—	—	—	—	—	TK38400TMD4	\$1815.00	—	—
600	1250	3000	TK138600MD4	—	—	—	TK138FMD	\$5296.00	TK38600TMD4	\$2813.00	—	—
600	2000	4000	TK138600MD5	—	—	—	—	—	TK38600TMD5	\$2813.00	—	—
800	1250	3000	TK138800MD4	—	TK13M8MD4	—	—	—	TK38800TMD4	\$2813.00	TK38M8TMD4	\$2813.00
800	2000	4000	TK138800MD5	—	TK13M8MD5	—	—	—	TK38800TMD5	\$2813.00	TK38M8TMD5	\$2813.00
K Frame — 1200 Amperes Maximum, Interchangeable Trip^{3,4}												
800	2000	4000	TK13A10MD5	—	—	—	TK13AFMD	\$7600.00	TK3A10TMD5	\$5923.00	—	—
800	2000	4000	TK13A12MD5	—	TK13M12MD5	—	—	—	TK3A12TMD5	\$5923.00	TK3M12TMD5	\$5923.00

¹The lugs recommended for use with all Mine Duty breakers are copper for use with copper cable. Select from page 3-101.

²Applies only to magnetic-only breakers.

³Order frame plus trip unit; not available as complete breaker.

⁴Not suitable for use on dc.

Accessories: See pages 3-85 to 3-104.

MOLDED CASE CIRCUIT BREAKERS

3



Replacement Breakers

TriBreak
Internally Fused

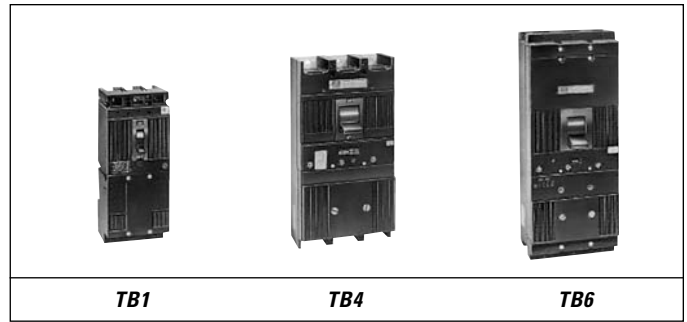

TB1, 150A Frame, Noninterchangeable Trip (Includes line and load lugs) GO-135B

Ampere Rating	Adjustable Instantaneous Trip Amperes Range Low High		Tri-Break—Including Current Limiters ¹		Lugs ²		Replacement		Current Limiters ¹			
			Three-Pole		Product No. and Wire Sizes (order 2 per pole)	List Price	Trip Units ³ Product Number	List Price	Standard Product Number	List Price	Optional ¹ Product Number	List Price
			Product Number	List Price								
15	Fixed		TB13015BWE05	\$2680.00 ⁴	TCAL14 #14-8 Cu-Al	\$14.00	Lugs Furnished with Breaker	TB4E05	\$280.00 ⁴	Not Available		
20	Fixed		TB13020BWE05	\$2680.00 ⁴								
25	Fixed		TB13025BWE05	\$2680.00 ⁴								
30	Fixed		TB13030BWE05	\$2680.00 ⁴								
35	Fixed		TB13035BWE05	\$2680.00 ⁴								
40	Fixed		TB13040BWE05	\$2680.00 ⁴	TCAL 12 #14-2/0 Cu-Al	\$14.00	Lugs Furnished with Breaker	TB7E09	\$360.00 ⁴	TB4E05	\$280.00 ⁴	
45	Fixed		TB13045BWE05	\$2680.00 ⁴								
50	Fixed		TB13050BWE09	\$2680.00 ⁴								
60	Fixed		TB13060BWE09	\$2680.00 ⁴								
70	Fixed		TB13070BWE09	\$2680.00 ⁴								
80	Fixed		TB13080BWE09	\$2680.00 ⁴								
90	Fixed		TB13090BWE09	\$2680.00 ⁴								
100	Fixed		TB13100BWE09	\$2680.00 ⁴								
100NA	-		TB13BYWE09 ^{5,6}	\$2680.00 ⁴								

TB4, 400A Frame, Interchangeable Trip (Without line or load lugs) GO-135B

Ampere Rating	Adjustable Instantaneous Trip Amperes Range Low High		Tri-Break—Including Current Limiters ¹		Lugs ²		Replacement		Current Limiters ¹				
			Three-Pole		Product No. and Wire Sizes (order 2 per pole)	List Price	Trip Units ³ Product Number	List Price	Standard Product Number	List Price	Optional ¹ Product Number	List Price	
			Product Number	List Price									
125	375	1250	TB43125AF14	\$4079.00	TCAL43 (1) 6-600 kcmil or (2) 2/0-250 kcmil	\$14.00	Lugs Furnished with Breaker	TB43T125	\$473.00	TB10F14	\$377.00	TB3F05 or TB6F09	\$401.00 or \$377.00
150	450	1500	TB43150AF14	\$4079.00									
175	525	1750	TB43175AF14	\$4079.00									
200	600	2000	TB43200AF14	\$4079.00									
225	675	2250	TB43225AF14	\$4079.00									
250	750	2500	TB43250AF14	\$5542.00									
300	900	3000	TB43300AF14	\$5542.00									
350	1050	3500	TB43350AF14	\$5542.00									
400	1200	3500	TB43400AF14	\$5542.00									
400NA	-	-	TB43AYW F14 ^{5,6}	\$4802.00									

¹Standard current limiters (bolt on: TB1, TB6, TB8 and plug-in: TB4) have been selected based upon recommended coordination with thermal magnetic trip characteristics of the breaker. Optional current limiters are not UL listed in combination with breaker except TB4 with TB3F05 or TB6F09, 250A maximum.

²For optional lugs, see page 3-101.

³Trip units fit 2 and 3 pole frames.

⁴GO-148D.

⁵Molded case switch. Includes dummy trip, line and load lugs.

⁶Not UL listed.



Replacement Breakers

TriBreak
Internally Fused

TB6, 600A Frame, Interchangeable Trip (Without line or load lugs)

GO-135B

Ampere Rating	Adjustable Instantaneous Trip Amperes Range		Tri-Break—Including Current Limiters ¹		Lugs ²		Replacement					
			Three-Pole		Product No. and Wire Sizes (order 2 per pole)	List Price	Trip Units ³		Current Limiters ¹		Optional ¹ Product Number	List Price
			Product Number	List Price			Product Number	List Price	Standard Product Number	List Price		
300	1200	3500	TB63300BJ14	\$7123.00	TCAL61 (2) 2/0-500 kcmil	\$40.00	TB63T300	\$2334.00	TB10BJ14	\$543.00	TB3BJ05 or TB6BJ09	\$579.00
350	1200	3500	TB63350BJ14	\$7123.00			TB63T350	\$2334.00				
400	1200	3500	TB63400BJ14	\$7123.00			TB63T400	\$2334.00				
500	1200	3500	TB63500BJ14	\$7123.00			TB63T500	\$2334.00				
600	1200	3500	TB63600BJ14	\$7123.00			TB63T600	\$2334.00				
600NA	-	-	TB63BYWJ14 ⁴	\$6894.00	-	-	-	-	-	-	-	-

TB8, 800A Frame, Interchangeable Trip (Without line or load lugs)

GO-135B

Ampere Rating	Adjustable Instantaneous Trip Amperes Range		Tri-Break—Including Current Limiters ¹		Lugs ²		Replacement					
			Three-Pole		Product No. and Wire Sizes (order 2 per pole)	List Price	Trip Units ³		Current Limiters ¹		Optional ¹ Product Number	List Price
			Product Number	List Price			Product Number	List Price	Standard Product Number	List Price		
600	1800	3000	TB83600BK22	\$8204.00	TCAL81 (3) 250-500 kcmil	\$47.00	TB83T600	\$2334.00	TB15K22	543.00	TB6BJ09 ⁵ or TB10BJ14 ⁵	\$543.00
700	2100	4000	TB83700BK22	\$8204.00			TB83T700	\$2334.00				
800	2400	4000	TB83800BK22	\$8204.00			TB83T800	\$2334.00				
800NA	-	-	TB83AYWK22 ^{4,5}	\$8204.00	-	-	-	-	-	-	-	-

Old Style (Plug-in) Replacement Limiters

Breaker Type	Ampere Range	Replacement Limiter ¹	
		Standard	Optional ¹
TB1	15-45	TB3E05	
TB1	50-100	TB6E09	TB3E05
TB1	110-150	TB7E10	TB7E09
TB6	300-600	TB10J14	TB3J05 TB6J09
TB8	600-800	TB15K18	-

¹Standard current limiters (bolt on: TB1, TB6, TB8 and plug-in: TB4) have been selected based upon recommended coordination with thermal magnetic trip characteristics of the breaker. Optional current limiters are not UL listed in combination with breaker except TB4 with TB3F05 or TB6F09, 250A maximum.

²For optional lugs, see page 3-101.

³Trip units fit 2 and 3 pole frames.

⁴Molded case switch. Includes dummy trip, line and load lugs.

⁵Not UL listed.

⁶GO-135S.

MOLDED CASE
CIRCUIT BREAKERS

3

www.DataSheet4U.com



Replacement Breakers

THLC Current Limiting

Unfused

15-400 Amperes

20kAIC @ 240 Vac max.

20kAIC @ 480 Vac max.

50kAIC @ 600 Vac max.

THLC1, 150A Frame, 15-150 Amperes, Noninterchangeable Trip with Line and Load Lugs **GO-135B**

Ampere Rating	3-Pole Product Number	List Price
15	THLC136015WL	\$2910.00
20	THLC136020WL	\$2910.00
30	THLC136030WL	\$2910.00
40	THLC136040WL	\$2910.00
50	THLC136050WL	\$2910.00
60	THLC136060WL	\$2910.00
70	THLC136070WL	\$2910.00
80	THLC136080WL	\$2910.00
90	THLC136090WL	\$2910.00
100	THLC1360100WL	\$2910.00
125	THLC1360125WL	\$5520.00
150	THLC1360150WL	\$5520.00

Internal accessories for THLC1 are same as Type TED accessories. Refer to pages 3-86 to 3-91.

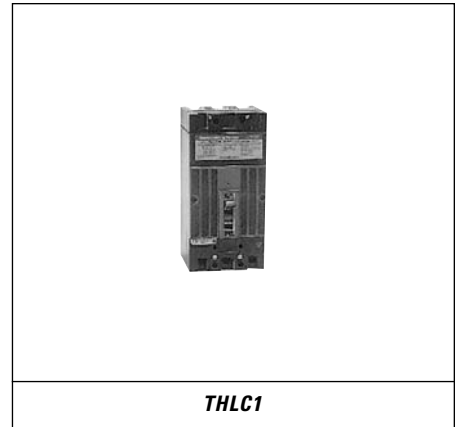

THLC2, 225A Frame, 125-225 Amperes, Noninterchangeable Trip with Line and Load Lugs **GO-135B**

Ampere Rating	Adjustable Trip Range Amperes		3-Pole Product Number	List Price
	Low	High		
125	550	1250	THLC236125WL	\$5540.00
150	675	1500	THLC236150WL	\$5540.00
175	775	1750	THLC236175WL	\$5540.00
200	900	2000	THLC236200WL	\$5540.00
225	1000	2500	THLC236225WL	\$5540.00

Internal accessories for THLC2 and THLC4 are same as Type TFK accessories. Refer to pages 3-87 to 3-91. Accessory must have code date 535+ or later.

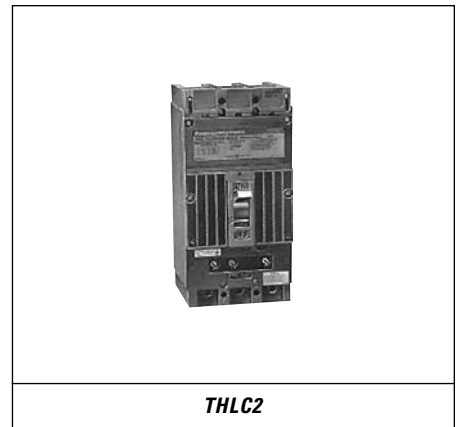

THLC4, 400A Frame, 250-400 Amperes, Noninterchangeable Trip without Line and Load Lugs¹ **GO-135B**

Ampere Rating	Adjustable Trip Range Amperes		3-Pole Product Number	List Price
	Low	High		
250	1175	2500	THLC436250	\$7450.00
300	1400	3000	THLC436300	\$7450.00
350	1650	3500	THLC436350	\$7450.00
400	1870	4000	THLC436400	\$7450.00

¹Lug kit for THLC4 for line or load end. Order Product Number TCLK43, List Price \$49.00, GO-135B. Consists of three-pole assembly. Wire range (1) 3/0-500 or (2) 3/0-250 Cu-Al.



www.DataSheet4U.com

Publications and Reference: See Section 21 for a list of additional product-related publications



www.DataSheet4U.com

Replacement Breakers

J and K Frame Circuit Breakers with MicroVersaTrip Plus Trip Units

For Replacement Use Only

For New Breaker Designs, use Spectra RMS Breakers with MicroVersaTrip Plus

How To Order

- Determine the required breaker frame (i.e. 600 or 1200 amperes), IC rating, and load requirements (UL Standard or 100%). Select frame product number and list price from table below.
- Select and price the appropriate trip unit from table below.
- Select and price the required rating plug from table below. The sensor rating of frame must match the sensor rating of the rating plug in table.
- Select and price lugs and lug covers as required from pages 3-101 and 3-102.
- When ordering, specify separate product numbers as follows.
The trip unit will be installed in the frame. Rating plugs and lugs/lug covers will be shipped unassembled.
- Frame
- Trip Unit
- Rating plug
- Lugs/Lug covers
- Other accessories (assembled or separate items)

Pricing Example

J600 frame, 300 ampere sensor, 250 ampere rating plug, 35kAIC, 480 Vac, IC 100% rated, trip unit functions to include long-time (L), short-time (S), instantaneous (I), ground fault (G), trip targets (T2), ground fault/short-time zone selective interlocking (Z2), 3-phase/3-wire system.

Description	Product Number	List Price, GO-135D
Frame	TJH3SS	\$4774.00
Trip Unit and Suffix Adder	TS20LSIGT2Z2	\$4915.00
Rating Plug	TR3S250J	\$106.00
Zone Interlock Module (120 Vac)	TIM1	\$402.00 ¹
Neutral Current Sensor	TSRG203	\$532.00 ²

¹GO-245B.

²GO-135S.

MicroVersaTrip Plus Trip Unit Characteristics

Current Setting (Multiple of rating plug ampere) (X)	Long-Time ²		Short-Time		Adjustable Instantaneous Pick-Up (Multiple of Rating Plug Amperes) (X)	Ground Fault	
	Delay (Seconds)	Pick-Up (Multiple of Current Setting) (C)	Delay (Seconds)	Pick-Up (Multiple of Sensor Ampere Rating) (S)		Delay (Seconds)	
1.0, .95, .90, .85, .80, .70, .60, .50	2.4, 4.9, 9.8, 20 at 600% of current setting at lower limit of each band	1.5, 2.0, 2.5, 3.0, 4.0, 6.0, 7.0, 9.0	I^2t in; ³ .44 I^2t out; ⁵ .10, .21, .35	1.5, 2.0, 3.0, 5.0, 7.0, 9.0, 10.0 without short-time 1.5, 2.0, 3.0, 5.0, 7.0, 9.0, 10.0, 13.0, 15.0 ⁶ with short-time	.20, .25, .30, .35, .40, .45, .50, .60	I^2t in; ⁴ .44 I^2t out; ⁵ .10, .21, .35	

²Pick-up fixed at 1.1C.

³Time delay at 600% of current setting at lower limit of band.

⁴Time delay at 200% of pick-up setting at lower limit of band.

⁵Time delay shown at lower limit of each band. Pick-up tolerances ±10%. Ground fault pick-up not to exceed 1200 amperes.

⁶J600 frame with 600 amp sensor for high IC 65kA rating (TJL) limited to 10X

X = rating plug amperes

S = sensor ampere rating

C = current setting

Circuit Breaker Frame Selection (less lugs)

GO-135D

Frame Type	Sensor Rating (Amperes)	65 kAIC Product Number	List Price	100% 65 kAIC Product Number	List Price	Hi-Break Product Number	List Price	100% Hi-Break ⁷ Product Number	List Price
J600	150	TJL1S	\$5149.00	TJL1SS	\$5919.00	TJH1S	\$4151.00	TJH1SS	\$4774.00
	300	TJL3S	\$5149.00	TJL3SS	\$5919.00	TJH3S	\$4151.00	TJH3SS	\$4774.00
	400	TJL4S	\$5149.00	TJL4SS	\$5919.00	TJH4S	\$4151.00	TJH4SS	\$4774.00
	600	TJL6S	\$6222.00	TJL6SS	\$7155.00	TJH6S	\$5018.00	TJH6SS	\$5771.00
K1200	800	TKL8S	\$8603.00	TKL8SS	\$9892.00	TKH8S	\$6935.00	TKH8SS	\$7975.00
	1200	TKL12S	\$12536.00	TKL12SS	\$14414.00	TKH12S	\$10108.00	TKH12SS	\$11624.00

⁷100% supplied with back-connected assembly which increases breaker depth. Refer to outline drawing 139C4335 Sh7 for details.



Replacement Breakers

J and K Frame Circuit Breakers with MicroVersaTrip Trip Units
For Replacement Use Only

For New Breaker Designs, use Spectra RMS Breakers with MicroVersaTrip Plus

J/K Rating Plug Selection—All plugs List Price, \$106.00				GO-135D			
Frame Type	Sensor Rating (Amperes)	Current Rating (Amperes)	Rating Plug Product Number	Frame Type	Sensor Rating (Amperes)	Current Rating (Amperes)	Rating Plug Product Number
J600	150	60	TR1S60J	J600	600	300	TR6S300J
		80	TR1S80J			400	TR6S400J
		100	TR1S100J			450	TR6S450J
		125	TR1S125J			500	TR6S500J
	300	150	TR1S150J	K800	800	600	TR6S600J
		150	TR3S150J			300	TR6S300K
		200	TR3S200J			400	TR6S400K
		225	TR3S225J			500	TR6S500K
		250	TR3S250J			600	TR6S600K
		300	TR3S300J			700	TR6S700K
	400	150	TR4S150J	K1200	1200	800	TR6S800K
		200	TR4S200J			600	TR12S600K
225		TR4S225J	800			TR12S800K	
250		TR4S250J	1000			TR12S1000K	
		300	TR4S300J			1200	TR12S1200K
		400	TR4S400J				

Trip Unit Function Definitions

Long-Time (L)	Adjustable current setting Adjustable long-time delay
Short-Time (S)	Adjustable short-time pick-up Adjustable short-time delay with I ² t Adjustable short-time delay without I ² t
Instantaneous (I)	Adjustable pick-up
Ground Fault (G)	Adjustable ground fault pick-up Adjustable ground fault delay with I ² t Adjustable ground fault delay without I ² t
Trip Indication Target (T1, T2)	Overload/short circuit targets (T1) Overload/short circuit/ground fault targets (T2)
Zone Selective Interlock (Z1, Z2)	Ground fault (Z1) Ground fault/short-time (Z2)

MicroVersaTrip Trip Unit Selection

GO-135D

Trip Unit Suffix	List Price	Long-Time (L)	Short-Time (S)	Instantaneous (I)	Ground Fault ¹ (G)	Targets		Zone Interlock	
						OL, SC (T1)	OL, SC, GF (T2)	GF (Z1)	GF, ST (Z2)
TS20LIT1	\$755.00	•	–	•	–	•	–	–	–
TS20LSIT1	\$2120.00	•	•	•	–	•	–	–	–
TS20LIGT2	\$2380.00	•	–	•	•	–	•	–	–
TS20LSIGT2	\$3745.00	•	•	•	•	–	•	–	–
TS20LIGT2Z1	\$3965.00	•	–	•	•	•	–	•	–
TS20LSIGT2Z1	\$4330.00	•	•	•	•	–	•	•	–
TS20LSIGT2Z2	\$4915.00	•	•	•	•	–	•	–	•

¹For single-phase, 3-wire or three-phase, 4-wire applications select appropriate neutral-current sensor from page 3-103.

Publications and Reference: See Section 21 for a list of additional product-related publications



Replacement Breakers

J and K Frame Circuit Breakers with Power+ 4 Trip Unit

Part Number Selection Instructions

1. Select product number of circuit breaker, including trip unit suffix.
2. Select lugs, internal/external accessories and neutral current sensor, as required from pages 3-85 through 3-104.

Power+ Trip Unit Characteristics

Frame Type	Max. Amperes	(X) Fixed Sensor		Long-Time		Short-Time 1,2		Adjustable Instantaneous Pick-Up ¹ (Multiple of Sensor Current Rating) (X)	Ground Fault ²	
		Sensor Current Ratings (Amperes)	Current Setting (Multiple of Sensor Current Rating) (X)	Pick-up (Multiple of Current Setting) (C)	Delay ³ (Seconds)	Pick-up (Multiple of Current Setting) (C)	I ² t Delay Ramp ³ (Seconds)		Pick-Up (Multiple of Sensor Current Rating) (X)	Delay ⁴ (Seconds)
J600	600	150, 200 300, 400, 500, 600	.5, .6, .7, .8, .9, .95, 1.0 (X)	.5, .6, .7, .8, .9, .95, 1.0	3, 6, 12, 25 Bands 1, 2, 3, 4	1.5, 2, 2.5, 3, 4, 5, 7, 9 (C)	.13, .26, .42 (Min, Int, Max)	1.5, 2, 3, 4, 5, 7, 9, 10 (X)	.2, .25, .3, .35, .4, .45, .5, .6 (X)	0.10, 0.21 0.35 (Min, Int, Max)
K1200	1200	800, 1000, 1200								

¹ When optional adjustable short-time pick-up is provided, instantaneous is fixed at 15X. Short-time and fixed instantaneous are not available on TJL with 500A and 600A sensors.

² Delay Curve = I²t in, I²t out

³ Time delay shown at 600% of current setting at lower limit of each band.

⁴ Time delay shown at lower limit of each band. All pick-up tolerances are ± 10%. Ground Fault Pick-up not to exceed 1200 amperes.

X = sensor current rating

C = current setting

Select trip unit product number from specific circuit breaker pages—J and K frames, page 3-81.

Circuit Breaker Product Number Selection (less lugs)⁵

Frame Type	Current Sensor Ampere	Standard Circuit Breaker				Hi-Break					
		Base Product No.	List Price, GO-148D with Suffix				Base Product No.	List Price, GO-148D with Suffix			
			None	N	G	NG		None	N	G	NG
J600	150	TJ4V2601A	\$2703.00	\$2703.00	\$3909.00	\$3909.00	THJ4V2601A	\$3858.00	\$3858.00	\$5064.00	\$5064.00
	200	TJ4V2602A	\$2703.00	\$2703.00	\$3909.00	\$3909.00	THJ4V2602A	\$3858.00	\$3858.00	\$5064.00	\$5064.00
	300	TJ4V2603A	\$2703.00	\$2703.00	\$3909.00	\$3909.00	THJ4V2603A	\$3858.00	\$3858.00	\$5064.00	\$5064.00
	400	TJ4V2604A	\$2703.00	\$2703.00	\$3909.00	\$3909.00	THJ4V2604A	\$3858.00	\$3858.00	\$5064.00	\$5064.00
	500	TJ4V2605A	\$3657.00	\$3657.00	\$4863.00	\$4863.00	THJ4V2605A	\$4611.00	\$4611.00	\$5816.00	\$5816.00
	600	TJ4V2606A	\$3657.00	\$3657.00	\$4863.00	\$4863.00	THJ4V2606A	\$4611.00	\$4611.00	\$5816.00	\$5816.00
K1200	800	TK4V4608A	\$4694.00	\$4694.00	\$5900.00	\$5900.00	—	—	—	—	—
	1000	TK4V4610A	\$8183.00	\$8183.00	\$9389.00	\$9389.00	—	—	—	—	—
	1200	TK4V4612A	\$8183.00	\$8183.00	\$9389.00	\$9389.00	—	—	—	—	—

Circuit Breaker Product Number Selection (less lugs)^{5,6}

Frame Type	Current Sensor Ampere	65 kAIC Breaker				
		Base Product No.	List Price, GO-148D with Suffix			
			None	N	G	NG
J600	150	TJL4V2601A	\$4242.00	\$4242.00	\$5448.00	\$5448.00
	200	TJL4V2602A	\$4242.00	\$4242.00	\$5448.00	\$5448.00
	300	TJL4V2603A	\$4242.00	\$4242.00	\$5448.00	\$5448.00
	400	TJL4V2604A	\$4242.00	\$4242.00	\$5448.00	\$5448.00
	500	TJL4V2605A ²	\$5071.00	7	\$6275.00	7
	600	TJL4V2606A ²	\$5071.00	7	\$6275.00	7
K1200	800	TKL4V4608A	\$5658.00	\$5658.00	\$6864.00	\$6864.00
	1000	TKL4V4610A	\$9154.00	\$9154.00	\$10360.00	\$10360.00
	1200	TKL4V4612A	\$9154.00	\$9154.00	\$10360.00	\$10360.00

⁵ For single-phase, 3-wire or three phase, 4-wire applications, select appropriate neutral-current sensor from page 3-103.

⁶ Select and price lugs and lug covers as required from pages 3-101 and 3-102.

• = Function included.

Power+ 4 Trip Unit Selection

Trip Unit Functions	Suffix			
	None	W	G	NG
Adjustable Current Setting	•	•	•	•
Long-Time				
Fixed Long-Time Pick-Up	•	•	•	•
Fixed Long-Time Delay	•	•	•	•
Long-Time Timing Light	•	•	•	•
Short-Time				
Adj. Short-Time Pick-Up	—	•	—	•
Fixed Short-Time Delay I ² t Ramp	—	•	—	•
Instantaneous				
Adj. Instantaneous Pick-Up	•	—	•	—
Fixed Instantaneous Pick-Up ⁷	—	•	—	•
Ground Fault ⁵				
Adj. Ground Fault Pick-Up Zero Sequence	—	—	•	•
Adj. Ground Fault Delay	—	—	•	•

⁷ TJL4V with 500 and 600A sensors available with adjustable instantaneous only.



Internal Accessories

Spectra RMS Circuit Breakers

Universal Field-Installable Internal Accessories

All Spectra RMS circuit breakers from the SE150 through the SK1200, including instantaneous-trip Mag Break motor circuit protectors and molded case switches, use the same UL listed, field-installable internal accessories that do not require cover removal to install.

Accessory Mounting

All accessories mount in pouches accessible from a front cover. All breakers have a left-side pouch and right-side pouch. The following combinations may be installed:

Left-Side Pouch—either shunt trip or undervoltage release plus bell alarm.

Right-Side Pouch—auxiliary switch (single or double pole).

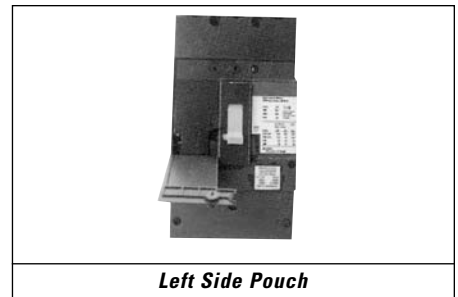

Left Side Pouch

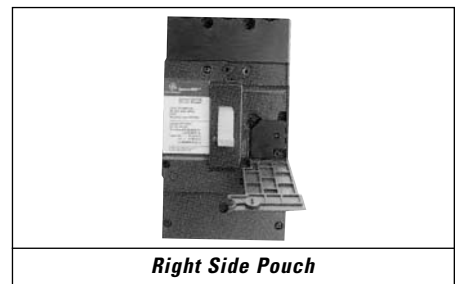

Right Side Pouch

Auxiliary Switch

GO-135S

Auxiliary switches provide remote indication of whether the circuit breaker main contacts are opened or closed via open or closed SPDT switch elements.

Switch Rating	Number of Switch Elements	Auxiliary Switch Product Number	List Price
5A @ 240 Vac/ 0.5A @ 125 Vdc	1 form C	SAUXPAB1	\$149.00
	2 form C	SAUXPAB2	\$295.00
Gold-Plated Contacts	1 form C	SAUXGAB1	\$149.00
0.5A @ 30V	2 form C	SAUXGAB2	\$295.00
One each of above types	2 form C	SAUXGPAB2	\$295.00

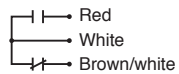

All accessory contacts shown with the circuit breaker in tripped position.

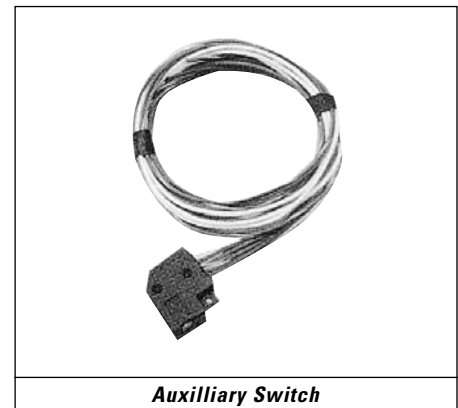

Auxilliary Switch

Shunt Trip

GO-135S

For remote tripping of breaker, use with momentary close contact. Not recommended for use with latching relay contact since electronics in shunt trip will pulse power to the coil if continuously energized, and breaker shunt tripping upon reclosure will be delayed 1-2 seconds at rated control voltage. (A short-circuit trip would be instantaneous.)

If maintained (latching relay) contact must be used and delayed shunt tripping is not acceptable, use small bell alarm in series with control power for SE150 and SF250 frames and auxiliary switch for SG600 and SK1200 breakers.

These devices are suitable for use with ground fault sensing and relaying equipment. Maximum VA is 75. AC devices are UL listed for 50-60 Hz.

Voltage		Current (mA)		Product Number	List Price
ac	dc	Inrush	Cont		
120	125	500	6.0	SAST1	\$363.00
240	250	400	5.0	SAST2	\$363.00
12	12	1000	800	SAST5 ¹	\$363.00
24	24	300	10.0	SAST3	\$363.00
48	48	300	10.0	SAST4	\$363.00

¹Not suitable for use with ground fault sensing and relaying equipment.

Note: UL listed at 200,000 AIC without internal accessories, 100,000 AIC with internally mounted accessories.

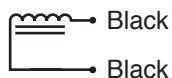

All accessory contacts shown with the circuit breaker in tripped position.

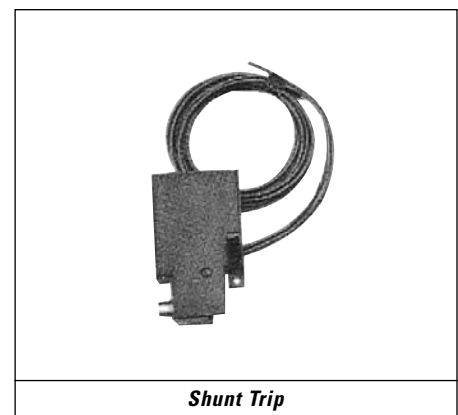

Shunt Trip

Publications and Reference: See Section 21 for a list of additional product-related publications

Internal Accessories

Spectra RMS Circuit Breakers

Undervoltage Release

GO-135S

The undervoltage release provides automatic circuit breaker tripping when there is a power loss or major dip (to 35%-70% of rated voltage) in accessory control voltage. AC devices are UL listed for 50-60 Hz. Product number SAUV1 may be used with time delay unit SPUVTD (List Price \$430.00, GO-245B) (delay 0.1 to 1.0 seconds), 120 Vac input, 125 Vdc output.

Voltage		Peak Current (mA)	Product Number	List Price
ac	dc			
120	125	200	SAUV1	\$363.00
240	250	200	SAUV2	\$363.00
24	24	100	SAUV3	\$363.00
48	48	100	SAUV4	\$363.00
120	125		SPUVTD	\$430.00 ¹

¹GO-245B.

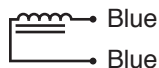

All accessory contacts shown with the circuit breaker in tripped position.

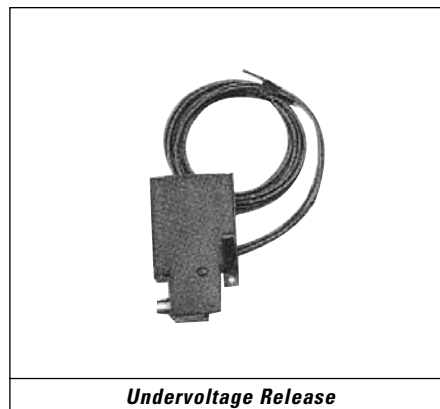

Undervoltage Release

Bell Alarm Switch

GO-135S

The bell alarm switch provides remote indication of whether the circuit breaker has been tripped via open or closed SPDT switch elements, but remains unchanged during "On/Off" circuit breaker operation and during operation by the "Push-to-Trip" button.

Switch Rating	Number of Switch Elements	Product Number	List Price
5A @ 240 Vac/ 0.5A @ 125 Vdc	1 form C	SABAP1	\$154.00
Gold-Plated Contacts 0.5A @30V	1 form C	SABAG1	\$154.00

Note: UL listed at 200,000 AIC without internal accessories, 100,000 AIC with internally mounted accessories.

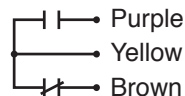

All accessory contacts shown with the circuit breaker in tripped position.



Bell Alarm Switch

MOLDED CASE
CIRCUIT BREAKERS

3



Internal Accessories

Molded Case Circuit Breakers

Accessory Devices and Ratings

Internally mounted accessories can be either factory or field installed, but should be factory installed when UL listing is required.

F225 frame accessories, including THLC2, and THLC4 are UL listed for field installation¹.

Factory installed devices with leads exiting from the side are UL listed, but when leads exit from the back the UL listing is void.

For accessory installation combinations refer to table below. "Mounting Pole" refers to left-, center- or right-hand pole as seen when facing the front of the breaker. Control leads may exit the breaker from its side (S) or back (B)².

Nonautomatic circuit breakers (molded case switches) require dummy trip units if internal accessories are to be field installed (refer to page 3-91).

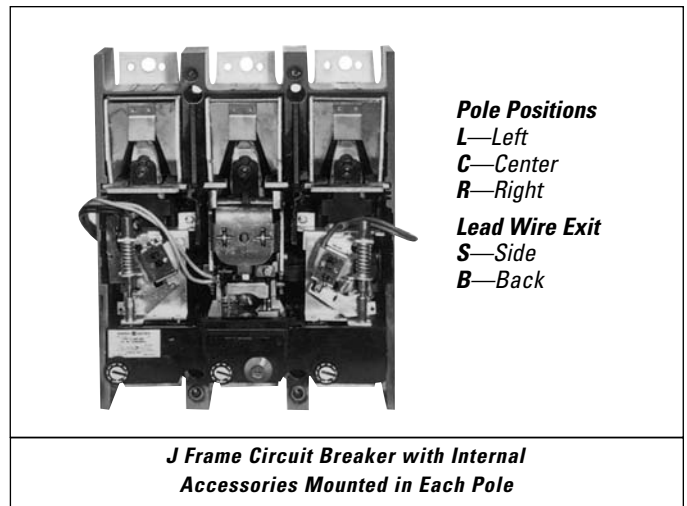

Breaker Type	Bell Alarm Switch			Auxiliary Switch ³ or Shunt Trip			Undervoltage Release			Three Coil Shunt Trip			Total Number of Accessories Within any One Circuit Breaker	
	Mounting Pole			Inst. Sheet GEH-		Mounting Pole		Inst. Sheet GEH-		Mounting Pole		Inst. Sheet GEH-		
	L	C	R	L	R	L	R	L	R	L	R	L	R	
TQB, THQB, THHQB, TXQB, TQL, THQL, THHQL, TXQL, TQC, THQC, THHQC, TXQC	—	—	—	—	—	UL	—	4	—	—	—	—	—	One accessory only. Mounts in a one-inch frame and increase overall breaker size by one pole. May be applied to 1-, 2-, or 3-pole breakers.
TQD, THQD	—	—	—	—	—	UL	—	4	—	—	—	—	—	One accessory only
E150 TEB, TEC, TED, THED, THLC ¹ , TB1 ^{5,6,8}	UL ⁷	—	UL	4576	UL ⁷	UL	3418 Aux 3416 S.T.	—	UL	3417	—	UL ⁸	3434	2-pole circuit breaker—any one 3-pole circuit breaker—any two except UVR and 3-coil shunt trip
F225 ⁹ TFC, TFJ, TFK, THFK, THLC2, THLC4, TLB2, TLB4	—	—	UL	4620	UL	UL	4653	UL	UL	4653	UL ⁸	UL	4622	any two
J600 TJC, TJD, TJJ, TJK, THJK, TB4 ⁹ , TBC4 ⁹	—	UL ⁸	—	3320	UL	UL	3321 Aux 3435 S.T.	—	UL	5407	UL ⁸	—	3346	Any two plus bell alarm except TB4, TBC4 any one plus bell alarm.
K1200 TKC, TKM, THKM, TB6 ⁹ , TBC6 ⁹ , TB8, TBC8	—	UL ⁸	—	4305	UL	UL	3321 Aux 3344 S.T.	—	UL	5408	UL ⁸	—	3346	Any two plus bell alarm
TJ4V, TKL4V, TJH6S, TKL12S ⁸ solid-state trips	—	UL	—	4626	—	UL	4623 Aux 4623 S.T.	—	UL	4623	—	—	—	Any one plus bell alarm

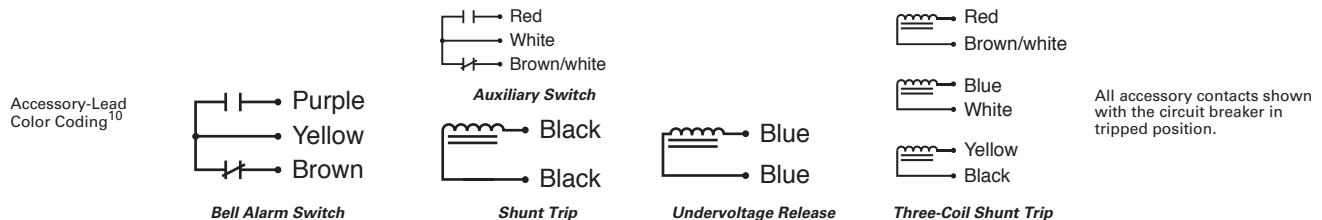

¹ Except TFC and TFJ, F225 line model 4 frames and trips (mfg. code date J101+ (1981 or later), and THLC2, THLC4, TLB4 are UL listed for field installation of most accessories.

² Not UL listed.

³ 600 Vac auxiliary switches are not UL listed.

⁴ Accessories are factory installed only.

⁵ UL listed at 200 AIC without internal accessories, 100 AIC with internally mounted accessories.

⁶ Accessories not available for single-pole TEB/TED frame. Use two-pole circuit breaker.

⁷ Left pole mounting not available for two-pole TEB, TED.

⁸ Not available with lead exit from the back of breaker.

⁹ UL listed interrupting capacity with accessories: 10 kAIC at 600 Vac, 22 kAIC at 480 Vac, 22 kAIC at 240 Vac.

¹⁰ Leads are #18 125°C Vulkene insulated.

Publications and Reference: See Section 21 for a list of additional product-related publications

Internal Accessories

Internally Mounted Signaling and Controlling Functions

How to Order

For factory installation, specify breaker product number, accessory base number, and appropriate suffix. (Example: Product Number TJK436125WL, TJUV1RS, TJKASA2AB2LS specifies a type TJK breaker with factory installed undervoltage release in the right-hand pole and an auxiliary switch in the left-hand pole.)

For field replacement, order the accessory by the base number only.

Where this number ends in "R" or "L" right-hand and left-hand devices are physically different. Specify only one suffix letter per accessory product number when option is available.

Nonautomatic circuit breakers require dummy trip units if internal accessories are to be mounted.

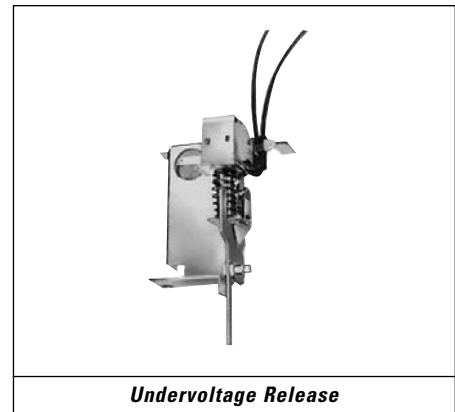

Mine Duty Circuit Breaker Undervoltage Release GO-135A

Circuit Breaker Frame	Control Voltage	Factory Installed ¹ Product Number Premium Duty	List Price	Field Replacement Product Number ²	List Price
E	24 Vac	TEDMDVAS	\$485.00	TEMVAS	\$485.00
	120 Vac	TEDMDVBS	\$485.00	TEMDVBS	\$485.00
	240 Vac	TEDMDVCS	\$485.00	TEMDVCS	\$485.00
	12 Vdc	TEDMDVDS	\$485.00	TEMDVDS	\$485.00
	24 Vdc	TEDMDVES	\$485.00	TEMDVES	\$485.00
	60 Vdc	TEDMDVFS	\$485.00	TEMDVFS	\$485.00
J	24 Vac	TJMDVAS	\$509.00	TJRMDVA	\$526.00
	120 Vac	TJMDVBS	\$509.00	TJRMDVB	\$526.00
	230 Vac	TJMDVCS	\$509.00	TJRMDVC	\$526.00
	12 Vdc	TJMDVDS	\$509.00	TJRMDVD	\$526.00
	24 Vdc	TJMDVES	\$509.00	TJRMDVE	\$526.00
	60 Vdc	TJMDVFS	\$509.00	TJRMDVF	\$526.00
K	24 Vac	TKMDVAS	\$509.00	TKRMDVA	\$526.00
	120 Vac	TKMDVBS	\$509.00	TKRMDVB	\$526.00
	240 Vac	TKMDVCS	\$509.00	TKRMDVC	\$526.00
	12 Vdc	TKMDVDS	\$509.00	TKRMDVD	\$526.00
	24 Vdc	TKMDVES	\$509.00	TKRMDVE	\$526.00
	60 Vdc	TKMDVFS	\$509.00	TKRMDVF	\$526.00

¹Mounts in right pole only. "S" suffix-wires out the side of breaker.

²Replacement for standard and premium duty mine duty UVR, both old and new design.

MOLDED CASE
CIRCUIT BREAKERS

3

www.DataSheet4U.com



Internal Accessories

Internally Mounted Signaling and Controlling Functions

Auxiliary Switches

GO-135B

Unless otherwise noted switch is SPDT rated 6 amperes at rated ac voltage, 1/2 amperes at 125 Vdc, 1/4 amperes at 250 Vdc.

Breaker Type	Number of SPDT Switch Elements	Control Voltage 240 Vac, 250 Vdc Maximum UL Listed When Factory Installed Suffix ¹			Control Voltage 600 Vac, 250 Vdc Maximum Not UL Listed Suffix ¹		
		Base Number	Add to Base Product Number for Factory Installation	List Price	Base Number	Add to Base Product Number for Factory Installation	List Price
TQB, THQB, THHQB, TXQB, TQL, ² THQL, THQL, TXQL	1 ³	TQAS2A1 ⁴	5	\$64.50	-	-	-
TQC, THQC, THHQC, TXQC ²	1 ³	TQCAS2A1 ⁴	5	\$77.50	-	-	-
TQD, THQD	1	TQDAS2AB1RS	N/A	\$148.00 ⁶	-	-	-
TEB, TEC, TB1	1	TEDAS2AB1R,L ^{7,8}	S	\$148.00	TEDAS6AB1R,L ^{7,8}	S	\$179.00
TED, THED, THLC1 ⁸	2	TEDAS2AB2R,L ^{7,8}	S	\$295.00	TEDAS6AB2R,L ^{7,8}	S	\$360.00
TFC, TFJ, TFK, THFK, ⁹	1	TFKASA2AB1 ¹⁰	RS or LS	\$148.00	TFKASA6AB1 ¹⁰	RS	\$167.00
THLC2, THLC4, TLB2, TLB4	2	TFKASA2AB2 ¹⁰	RS or LS	\$295.00	TFKASA6AB2 ¹⁰	RS	\$360.00
TJC, TJD, TJJ, TJK, THJK	1	TJKASA2AB1R,L	S	\$148.00	TJKASA6AB1R,L	S	\$179.00
	2	TJKASA2AB2R,L	S	\$295.00	TJKASA6AB2R,L	S	\$360.00
	3	TJKASA2AB3R,L	S	\$439.00	TJKASA6AB3R,L	S	\$530.00
	4	TJKASA2AB4R,L	S	\$598.00	TJKASA6AB4R,L	S	\$712.00
TB4, TBC4	1	TB4ASA2AB1R,L	S	\$148.00	TB4ASA6AB1R,L	S	\$179.00
	2	TB4ASA2AB2R,L	S	\$295.00	TB4ASA6AB2R,L	S	\$360.00
	3	TB4ASA2AB3R,L	S	\$439.00	TB4ASA6AB3R,L	S	\$530.00
	4	TB4ASA2AB4R,L	S	\$598.00	TB4ASA6AB4R,L	S	\$712.00
TKM, THKM, TKC, TB6, TB8, TBC6, TBC8	1	TKMAAS2AB1	RS or LS	\$148.00	TKMAAS6AB1	RS or LS	\$179.00
	2	TKMAAS2AB2	RS or LS	\$295.00	TKMAAS6AB2	RS or LS	\$360.00
	3	TKMAAS2AB3	RS or LS	\$439.00	TKMAAS6AB3	RS or LS	\$530.00
	4	TKMAAS2AB4	RS or LS	\$598.00	TKMAAS6AB4	RS or LS	\$712.00
TJ4V/TJL, TK4V/TKL	2	TVAS2AB2R ¹⁰	S	\$297.00 ¹¹	TVAS6AB2R	S	\$341.00 ¹¹
	4	TVAS2AB4R ¹⁰	S	\$553.00 ¹¹	TVAS6AB4R	S	\$657.00 ¹¹
	1	TPAS2AB1 ¹⁰	S	\$251.00 ¹²	TPAS6AB1	S	\$251.00 ¹²
	2	TPAS2AB2 ¹⁰	S	\$503.00 ¹²	TPAS6AB2	S	\$503.00 ¹²
	3	TPAS2AB3 ¹⁰	S	\$534.00 ¹²	TPAS6AB3	S	\$534.00 ¹²
	4	TPAS2AB4 ¹⁰	S	\$562.00 ¹²	TPAS6AB4	S	\$562.00 ¹²
TRL/TRP R Frame	5	TPAS2AB5 ¹⁰	S	\$623.00 ¹²	TPAS6AB5	S	\$623.00 ¹²
	6	TPAS2AB6 ¹⁰	S	\$680.00 ¹²	TPAS6AB6	S	\$680.00 ¹²
	7	TPAS2AB7S ¹⁰	Must be Factory Installed	\$924.00 ¹²	TPAS6AB7S	Must be Factory Installed	\$924.00 ¹²
	8	TPAS2AB8S ¹⁰	Must be Factory Installed	\$1180.00 ¹²	TPAS6AB8S	Must be Factory Installed	\$1180.00 ¹²
	9	TPAS2AB9S ¹⁰	Must be Factory Installed	\$1215.00 ¹²	TPAS6AB9S	Must be Factory Installed	\$1215.00 ¹²
	10	TPAS2AB10S ¹⁰	Must be Factory Installed	\$1240.00 ¹²	TPAS6AB10S	Must be Factory Installed	\$1240.00 ¹²
	11	TPAS2AB11S ¹⁰	Must be Factory Installed	\$1300.00 ¹²	TPAS6AB11S	Must be Factory Installed	\$1300.00 ¹²
	12	TPAS2AB12S ¹⁰	Must be Factory Installed	\$1365.00 ¹²	TPAS6AB12S	Must be Factory Installed	\$1365.00 ¹²

¹"S" suffix for wires out the side of breaker. For lead exit from back of breaker, replace suffix "S" with "B" and multiply list price by 1.25. "B" suffix not UL listed. Not available with leads out the back for "Q Line".

²Not available on GFCI (5 ma) or Equipment Ground Fault (30 ma) breakers.

³Switch is SPST. Operates like "A" side of an "AB" contact and is rated six amperes at 120 Vac and three amperes at 24 Vac.

⁴Accessories mounted in a one-inch frame and increase overall breaker size by one pole added to left side. May be applied to 1-, 2-, or 3-pole breakers. Must be factory installed. Maximum total breaker width is four poles.

⁵To order, specify both the accessory and breaker product number, e.g. THQL2130, TQASA1 identifies a 30 ampere, 2-pole plug-in breaker with a factory installed SPST auxiliary switch.

⁶GO-135F.

⁷Auxiliary switch mounts in right pole only on two-pole TEB, TED breakers. (Factory installed only.)

⁸Not available with "B" suffix-leads out back.

⁹Changes circuit breaker interrupting capacity to 10kAIC, 600 Vac; 22 kAIC, 240 and 480 Vac.

¹⁰UL listed for field installation.

¹¹GO-135C.

¹²GO-145A.



MOLDED CASE CIRCUIT BREAKERS 3

Internal Accessories

Internally Mounted Signaling and Controlling Functions

How to Order

For field replacement, order base number only. For factory installation, order base number plus appropriate suffix. For a nonautomatic breaker (molded case switch) a dummy trip is required when installing either a shunt trip or UVR.

Shunt Trip

Remote Tripping – Trips breaker by remote control. Trip coil de-energized when breaker opens. Device meets UL requirements for service to ground fault system.

Undervoltage Release

Undervoltage release automatically trips breaker when applied coil voltage drops to 30 to 70 percent of rated value. Time-delay unit prevent nuisance tripping due to momentary loss of voltage. Separate externally mounted unit has 120 Vac input and 125 Vdc output. Used in conjunction with 125 Vdc undervoltage release which must be ordered separately. Product number SPUVTD for adjustable delay .1 to 1.0 seconds. List Price \$430.00 GO-245B.

Shunt Trip

GO-135B

Breaker Type	Accessory Voltage		Product Number ^{1,2} — UL Listed When Factory Installed		List Price
	Vac	Vdc	Base Number for Field Replacement	Suffix Number ³	
				Add to Base Product Number for Factory Installation	
TOB, THQB, THQB, TXQB, TOL, THQL, THQL, TXQL	120-240	12	TQSTA ^{1,4,5,6,7}	10	\$95.50
			TQSTA ^{7,6,7}	10	\$95.50
			TQSTA ^{8,6,7}	10	\$95.50
TQC, THQC, THQC, TXQ	120-240	12	TQCSTA ^{1,4,6}	10	\$112.00
			TQCSTA ^{7,4,6}	10	\$112.00
			TQCSTA ^{8,4,6}	10	\$112.00
TOD, THOD	120	12	TQDSTA ^{8,9}	10	\$178.00
			TQDSTA ^{2,9}	10	\$178.00
			TQDSTA ^{7,9}	10	\$178.00
	240	24	TQDSTA ^{8,9}	10	\$178.00
			TEDST12	RS or LS ^{8,12}	\$363.00
			TEDST12	RS or LS ^{8,12}	\$363.00
TEB, TEC, TB1-B, ¹¹	480	12	TEDST13	RS or LS ^{8,12}	\$363.00
			TEDST13	RS or LS ^{8,12}	\$363.00
			TEDST7	RS or LS ^{8,12}	\$363.00
TED, THED, THLC1	600	24	TEDST8	RS or LS ^{8,12}	\$363.00
			TEDST9	RS or LS ^{8,12}	\$363.00
			TEDST12	RS or LS ^{8,12}	\$363.00
	120	250	TEDST11	RS or LS ^{8,12}	\$363.00
			TFKSTA12 ¹	RS or LS	\$363.00
			TFKSTA12 ¹	RS or LS	\$363.00
TFC, TFJ, TFK, THFK, THLC2, THLC4, TLB2, TLB4	240	12	TFKSTA13 ¹	RS or LS	\$363.00
			TFKSTA13 ¹	RS or LS	\$363.00
			TFKSTA13 ¹	RS or LS	\$363.00
	480	24	TFKSTA7 ¹	RS or LS	\$363.00
			TFKSTA8 ¹	RS or LS	\$363.00
			TFKSTA9 ¹	RS or LS	\$363.00
	600	48	TFKSTA12 ¹	RS or LS	\$363.00
			TFKSTA12 ¹	RS or LS	\$363.00
			TFKSTA11 ¹	RS or LS	\$363.00

¹UL listed for field installation on TFC, TFJ, TFK, and THFK model 4 frames and trips (mfg. Code date J101 or later) and on THLC2, THLC4, TLB4.

²For replacement voltage suppressor on 120 Vac UVRs for F225 line, order Product Number 286A8062G1. for 120 Vac UVRs on all other breaker lines, order Product Number 192A8300G1.

³"S" suffix for wires out the side of the breaker. For lead exit from back of breaker, replace suffix "S" with "B", and multiply "S" accessory List Price by 1.25. "B" suffix not UL listed. Not available with leads out the back on "Q Line."

⁴Mounts on a one-inch frame and increases overall breaker size by one pole added to left side. May be applied to 1-, 2-, or 3-pole breakers. Maximum total breaker width is 4-pole. Must be factory installed.

⁵A selective listing of breaker product numbers that include 120 Volt ac shunt trip appears on page 3-14.

⁶Not available on GFCI (5 ma) or Equipment Ground Fault (30 ma) breakers.

⁷TQST shunt trips not available on breakers over 100 A.

⁸Not available with "B" suffix—leads out back.

⁹Must be factory installed, right pole only.

¹⁰To order, specify both the accessory and breaker product number =, e.g. THQL2130, TQST1 identifies a 30 A, 2-pole plug-in breaker with a factory installed 120 Vac shunt trip.

¹¹For TB1 with bolt-on limiters.

¹²Mounts in the right pole only on 2-pole TEB, TED breakers.

MOLDED CASE CIRCUIT BREAKERS

3



Internal Accessories

Internally Mounted Signaling and Controlling Functions

Shunt Trip (continued)

GO-135B

Breaker Type	Accessory Voltage		Product Number ^{1,2} — UL Listed When Factory Installed		List Price
	Vac	Vdc	Base Number for Field Replacement	Suffix Number ³ Add to Base Product Number for Factory Installation	
TJC, TJD, TJJ, TJK, THJK	120		TJKSTA12R,L	S	\$363.00
	240		TJKSTA12R,L	S	\$363.00
	480		TJKSTA13R,L	S	\$363.00
	600		TJKSTA13R,L	S	\$363.00
		12	TJKSTA7R,L	S	\$363.00
		24	TJKSTA8R,L	S	\$363.00
		48	TJKSTA9R,L	S	\$363.00
		125	TJKSTA12R,L	S	\$363.00
		250	TJKSTA11R,L	S	\$363.00
	TB4, TBC4	120		TB4STA12R,L	S
240			TB4STA12R,L	S	\$363.00
480			TB4STA13R,L	S	\$363.00
600			TB4STA13R,L	S	\$363.00
		12	TB4STA7R,L	S	\$363.00
		24	TB4STA8R,L	S	\$363.00
		48	TB4STA9R,L	S	\$363.00
		125	TB4STA12R,L	S	\$363.00
		250	TB4STA11R,L	S	\$363.00
TKC, TKM, THKM, TB6, TB8, TBC6, TBC8 ⁴		120		TKMASTA12R,L	S
	240		TKMASTA12R,L	S	\$363.00
	480		TKMASTA13R,L	S	\$363.00
	600		TKMASTA13R,L	S	\$363.00
		12	TKMASTA7R,L	S	\$363.00
		24	TKMASTA8R,L	S	\$363.00
		48	TKMASTA9R,L	S	\$363.00
		125	TKMASTA12R,L	S	\$363.00
		250	TKMASTA11R,L	S	\$363.00
	TJ4V, TKL4V, TJH6S, TKL12S	120		TVST12R	S
240			TVST12R	S	\$363.00 ⁵
480			TVST13R	S	\$363.00 ⁵
600			TVST13R	S	\$363.00 ⁵
		12	TVST7R	S	\$363.00 ⁵
		24	TVST8R	S	\$363.00 ⁵
		48	TVST9R	S	\$363.00 ⁵
		125	TVST12R	S	\$363.00 ⁵
		250	TVST11R	S	\$363.00 ⁵
R Frame TRL, TRP		120		TPST12R	S
	240		TPST12R	S	\$630.00 ⁶
	480		TPST13R	S	\$630.00 ⁶
	600		TPST13R	S	\$630.00 ⁶
		12	TPST7R	S	\$630.00 ⁶
		24	TPST8R	S	\$630.00 ⁶
		48	TPST9R	S	\$630.00 ⁶
		125	TPST12R	S	\$630.00 ⁶
		250	TPST11R	S	\$630.00 ⁶

¹UL listed for field installation on TFC, TFJ, TFK, and THFK model 4 frames and trips (mfg. Code date J101 or later) and on THLC2, THLC4, TLB4.

²For replacement voltage suppressor on 120 Vac UVRs for F225 line, order Product Number 286A8062G1. for 120 Vac UVRs on all other breaker lines, order Product Number 192A8300G1.

³"S" suffix for wires out the side of the breaker. For lead exit from back of breaker, replace suffix "S" with "B", and multiply "S" accessory List Price by 1.25. "B" suffix not UL listed. Not available with leads out the back on "Q Line."

⁴Not UL listed.

⁵GO-135C UL listed for field installation.

⁶GO-145A UL listed for field installation.



Internal Accessories

Internally Mounted Signaling and Controlling Functions

UnderVoltage Release

GO-135B

Breaker Type	Accessory Voltage		Product Number ^{1,2} — UL Listed When Factory Installed		List Price	
	Vac	Vdc	Base Number for Field Replacement	Suffix Number ³ Add to Base Product Number for Factory Installation		
TEB, TEC, TB1-B ⁵ TED, THED, THLC1	120		TEDUV1	RS ⁸	\$363.00	
	240		TEDUV2	RS ⁸	\$363.00	
	480		TEDUV4	RS ⁸	\$363.00	
	600		TEDUV6	RS ⁸	\$363.00	
		12	TEDUV7	RS ⁸	\$363.00	
		24	TEDUV8	RS ⁸	\$363.00	
		48	TEDUV9	RS ⁸	\$363.00	
		125	TEDUV10	RS ⁸	\$363.00	
		250	TEDUV11	RS ⁸	\$363.00	
	TFC, TFJ, TFK, THFK, THLC2, THLC4, TLB2, TLB4	120		TFKUYA1 ¹	RS or LS	\$363.00
		240		TFKUYA2	RS or LS	\$363.00
480			TFKUYA4	RS or LS	\$363.00	
600			TFKUYA6	RS or LS	\$363.00	
		12	TFKUYA7	RS or LS	\$363.00	
		24	TFKUYA8	RS or LS	\$363.00	
		48	TFKUYA9	RS or LS	\$363.00	
		125	TFKUYA10	RS or LS	\$363.00	
		250	TDKUYA11	RS or LS	\$363.00	
TJC, TJD, TJJ, TJK, THJK		120		TJUV1R	S	\$363.00
		240		TJUV2R	S	\$363.00
	480		TJUV4R	S	\$363.00	
	600		TJUV6R	S	\$363.00	
		12	TJUV7R	S	\$363.00	
		24	TJUV8R	S	\$363.00	
		48	TJUV9R	S	\$363.00	
		125	TJUV10R	S	\$363.00	
		250	TJUV11R	S	\$363.00	
	TKC, TKM, THKM, TB6, TB8, TBC6, TBC8 ⁶	120		TKUV1R	S	\$363.00
		240		TKUV2R	S	\$363.00
480			TKUV4R	S	\$363.00	
600			TKUV6R	S	\$363.00	
		12	TKUV7R	S	\$363.00	
		24	TKUV8R	S	\$363.00	
		48	TKUV9R	S	\$363.00	
		125	TKUV10R	S	\$363.00	
		250	TKUV11R	S	\$363.00	
TJ4V, TKL4V, TJH6S, TKL12S ⁵		120		TVUV1R	S	\$363.00 ⁷
		240		TVUV2R	S	\$363.00 ⁷
	480		TVUV4R	S	\$363.00 ⁷	
	600		TVUV6R	S	\$363.00 ⁷	
		12	TVUV7R	S	\$363.00 ⁷	
		24	TVUV8R	S	\$363.00 ⁷	
		48	TVUV9R	S	\$363.00 ⁷	
		125	TVUV10R	S	\$363.00 ⁷	
		250	TVUV11R	S	\$363.00 ⁷	
		380	TVUV3R	S	\$363.00 ⁷	
	R Frame TRL, TRP ⁵	120		TPUV1	S	\$630.00 ⁸
240			TPUV2	S	\$630.00 ⁸	
480			TPUV4	S	\$630.00 ⁸	
600			TPUV6	S	\$630.00 ⁸	
		12	TPUV7	S	\$630.00 ⁸	
		24	TPUV8	S	\$630.00 ⁸	
		48	TPUV9	S	\$630.00 ⁸	
		125	TPUV10	S	\$630.00 ⁸	
		250	TPUV11	S	\$630.00 ⁸	

¹UL listed for field installation on TFC, TFJ, TFK, and THFK model 4 frames and trips (mfg. Code date J101 or later) and on THLC2, THLC4, TLB4.

²For replacement voltage suppressor on 120 Vac UVRs for F225 line, order Product Number 286A8062G1 for 120 Vac UVRs on all other breaker lines, order Product Number 192A8300G1.

³"S" suffix for wires out the side of the breaker. For lead exit from back of breaker, replace suffix "S" with "B"; and multiply "S" accessory List Price by 1.25. "B" suffix not UL listed. Not available with leads out the back on "Q Line."

⁴For TB1 with bolt-on limiters.

⁵Not available with "B" suffix — leads out back.

⁶Not UL listed.

⁷GO-135C UL listed for field installation.

⁸GO-145A UL listed for field installation.

MOLDED CASE
CIRCUIT BREAKERS

3



Internal Accessories

Internally Mounted Signaling and Controlling Functions

Heavy-Duty Undervoltage Release¹ GO-135B

Automatically trips breaker when an undervoltage or power outage condition occurs. Special PUSH-TO-TRIP/PUSH-TO-RESET button is used to manually trip the breaker (E-frame only). On J and K frames, the UVR is handle resettable with a cover-mounted button to provide local mechanical tripping.

The Heavy-Duty Undervoltage Release (UVR) is designed for applications where repeated UVR trips are anticipated. The manual reset feature prevents breaker reset or possible contact kiss until power is available and reset button is depressed.

Mounts in right pole of breaker only. Must be factory installed to incorporate special breaker frame modifications.² Motor-operated mechanism cannot be provided when heavy-duty UVR is installed.

Breaker Type	Voltage		Product Number ³	List Price
	ac	dc		
TEB, TED, THED, TEC, TB14,5	24	–	TEDXUVARS ¹³	\$543.00
	120	–	TEDXUVBRS ¹³	\$543.00
	240	–	TEDXUVCRS ¹³	\$543.00
	–	12	TEDXUVDRS ¹³	\$543.00
	–	24	TEDXUVERS ¹³	\$543.00
	–	60	TEDXUVFRS ¹³	\$543.00
TJJ, TJK, THJK, TJD, TJC, TB4, TBC4	24	–	TJMDVAS	\$509.00 ⁷
	120	–	TJMDVBS	\$509.00 ⁷
	240	–	TJMDVCS	\$509.00 ⁷
	–	12	TJMDVDS	\$509.00 ⁷
	–	24	TJMDVES	\$509.00 ⁷
	–	60	TJMDVFS	\$509.00 ⁷
TKM, THKM, TKC, TB6, TB8, TBC6 ⁶ , TBC8 ⁶	24	–	TKMDVAS	\$509.00 ⁷
	120	–	TKMDVBS	\$509.00 ⁷
	240	–	TKMDVCS	\$509.00 ⁷
	–	12	TKMDVDS	\$509.00 ⁷
	–	24	TKMDVES	\$509.00 ⁷
	–	60	TKMDVFS	\$509.00 ⁷

¹Not UL listed when field installed.

²For replacement purposes, order from page 3-84 using field replacement Product Number.

³Add "B" suffix for leads exit from back of breaker; for price, multiply List Price by 1.25.

⁴For TB1 with bolt-on limiters.

⁵Not available with "B" suffix – leads out back.

⁶Not UL listed.

⁷GO-135A.

⁸Not available for two-pole TEB, TED. Order TEDBAR.

⁹Changes circuit breaker interrupting capacity to: 10kA @ 600 Vac, 22kA @ 480 Vac, 22kA @ 240 Vac, for TFC, TFJ, TFK and THFK only.

¹⁰UL listed for field installation.

¹¹Mounts in center pole with leads out left side.

¹²GO-135C.

¹³GO-145A.

Bell Alarm Switches GO-135B

Breaker Type	Product Number UL Listed When Factory Installed		List Price
	Base No.	Suffix	
TEB, TEC, TB1	TEDBAR or	S	\$154.00
TED, THED, THLC1	TEDBAL ^{5,8}		\$154.00
TFC, TFJ, TFK, THFK, THLC2, THLC4, TLB4	TFKBAAR ^{9,10}	S	\$154.00
TJC, TJJ, TJK, THJK, TB4, TBC4, TJD	TJKBAAL ¹¹	S	\$156.00
TKC, TKM, THKM, TB6, TBC6, TBC8, TB8	TKMABAAL ¹¹	S	\$141.00
TJL, TKL	TJVBALS TKVBALS	S	\$156.00 ¹² \$156.00 ¹²
(R Frame) TRL, TRP	TPSBAS	S	\$259.00 ¹³

Blown Fuse Detector-Three-Coil Shunt Trip GO-135B

Breaker Type	Product Number UL Listed When Factory Installed		List Price
	Base No.	Suffix	
TED, THED, TEC ⁵	TEDST316	RS	\$672.00
TFJ, TJK, THFK, TFC	TFKBF316	LS or RS	\$672.00
TJJ, TJK, THJK, TJD, TJC	TJKST316	LS	\$672.00
TKM, THKM, TKC	TKMAST316	LS	\$672.00
(R Frame) TRL, TRP	TPST316	S	\$1530.00 ¹³

Dummy Trip¹ GO-135B

Breaker Type	Product Number	List Price
E150	Internal accessories for these noninterchangeable breakers require factory-installed dummy trips.	No Charge
FJ225	Automatically supplied when accessories are ordered.	
JJ400		
FK225	TFKYT2 (two-pole)	\$148.00
FK225	TFKYT3 (three-pole)	\$208.00
JK400	TJKYT3 (two-pole, three-pole)	\$212.00
JK600	TJKYT36 (two-pole, three-pole)	\$212.00
KM800	TKMAYT3 (two-pole, three-pole)	\$261.00
KM1200	TKMA3YT12 (two-pole, three-pole)	\$424.00



External Accessories

Cable Operators

Spectra Flex Cable Operators

- UL Listed—File E-57253
- Reduced installation costs:
 - Simpler, faster installation
 - No special alignment required
- Optimized panel layout:
 - Breaker mounting position is independent of flange-mounted handle location
- Covers a full spectrum of enclosure types and sizes:
 - Flange-mounted handle for NEMA Types 1, 3R, 12 and 13 enclosures
 - Flange-mounted handle for NEMA 4/4X enclosures—optional
 - Broad range of enclosure sizes and breaker mounting configurations
 - 8 different operating cable lengths available from 3 to 10 feet
 - For circuit breaker types E150, SE150, SF250, SG600 and SK1200
 - Force and motion transmitted independently of breaker mounting plane or position relative to handle location
 - Common breaker mounted operator for SE150 and SF250 frames

Spectra Flex cable operating mechanisms are suitable for application with GE circuit breakers mounted in a wide variety of flanged enclosure types and sizes.

Flange-mounted handle mechanisms are available for NEMA Types 1, 12 or 13 enclosures in either 6 inch (Model SCH1) or 10 inch (Model SCH2) handle lengths. Corresponding mechanisms, SCH1X and SCH2X, are available for NEMA Type 4/4X enclosures. Handle mechanisms are suitable for either left or right flange operation.

The handle mechanism is combined with one of eight operating cables, with lengths from 3 to 10 feet, to cover a broad range of possible breaker mounting locations in the enclosure. The cable links the handle mechanism to the breaker-mounted operating mechanism and transmits the mechanical force and motion of the handle mechanism to the breaker mounted mechanism. The force and motion is transmitted independently of the breaker mounting plane or location relative to the location of the handle mechanism, provided only that the bending radius of the cable is not less than 3 inches. No mounting reinforcement of the breaker or enclosure flange is required.

The breaker-operating mechanism mounts directly to the face of the breaker and does not involve any mounting interface with the enclosure. A standard breaker mounting screw kit for tapped holes is furnished with each mechanism to mount the breaker in the enclosure.

See page 3-93 for ordering and pricing information.



www.DataSheet4U.com



External Accessories

Cable Operators

How to order

Use the circuit breaker mounting zone dimension table to determine the correct cable length for the application and ensure that the 3-inch minimum bending radius is not violated. Select the breaker mounted mechanism, operating cable and handle mechanism below. Order as separate components.

Publication References

Breaker types E150, SE150, SF250, SG600	GEH-6290
Breaker type SK1200	GEH-6291

See Section 21 for publication ordering information.

Maximum Dimensions in Inches

To determine the maximum mounting dimensions for 60-through 120-inch-long operating cables, add the respective additional lengths to the 48-inch cable maximum dimensions. (Example: Add 12 inches to E, F and G dimensions for 60-inch cable length.) When cable is installed, the minimum cable bend radius should not be less than 3 inches. The minimum cable bending requirement must be met to ensure a safe operating environment.

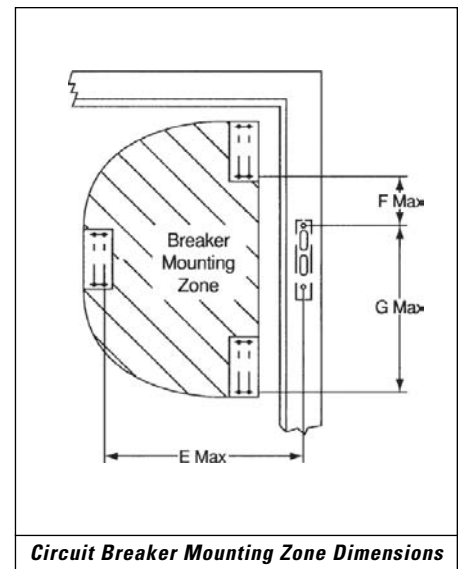

Maximum Mounting Dimensions (in.)

Box Depth	36" Cable			48" Cable		
	E ¹	F	G	E ¹	F	G
8"	13.5	4.0	15.0	25.5	16.0	27.0
10"	13.0	5.0	14.8	25.0	17.0	26.8
12"	12.8	6.0	14.5	24.8	17.0	26.5
16"	10.5	4.5	14.2	22.5	16.5	26.2
18"	8.5	3.5	12.6	20.5	15.5	24.6
20"	-	0.5	10.0	22.0	15.0	24.0
24"	-	-	-	19.5	14.0	22.0

¹Maximum E Dimension only if F = 4.5"

Operating Cables

GO-144A

Cable Length	Circuit Breaker Type			
	E150, SE150, SF250, SG600		SK1200	
	Product Number	List Price	Product Number	List Price
3'	SC3L	\$91.00	SC3H	\$119.00
4'	SC4L	\$108.00	SC4H	\$141.00
5'	SC5L	\$119.00	SC5H	\$163.00
6'	SC6L	\$134.00	SC6H	\$185.00
7'	SC7L	\$148.00	SC7H	\$207.00
8'	SC8L	\$163.00	SC8H	\$229.00
9'	SC9L	\$196.00	SC9H	\$251.00
10'	SC10L	\$211.00	SC10H	\$273.00

Breaker and Handle Mechanisms

Circuit Breaker Type	Breaker Mounted Mechanism		Flange-Mounted Handle Mechanism							
			NEMA Enclosure Type 1, 3R, 12, 13				NEMA Enclosure Type 4, 4X			
	Product Number	List Price GO-144A	6"		10"		6"		10"	
			Product Number	List Price GO-144A	Product Number	List Price GO-144A	Product Number	List Price GO-144A	Product Number	List Price GO-144A
E150	SCOM1A	\$96.00	-	-	-	-	-	-	-	-
SE150	SCOM1EF	\$133.00	SCH1	\$188.00	SCH2	\$322.00	SCH1X	\$258.00	SCH2X	\$373.00
SF250	SCOM1EF	\$133.00	-	-	-	-	-	-	-	-
SG600	SCOM1G	\$148.00	-	-	-	-	-	-	-	-
SK1200	SCOM1K	\$149.00	-	-	SCH2K	\$322.00	-	-	SCH2KX	\$373.00



External Accessories

Flange-Mounted Operators

Type STDA Flange Handles and Variable Depth Operating Mechanisms

- Designed to meet automotive duty specifications
- NEMA 12/13 and 4/4X UL Component Recognized components, File E-57253I CSA LR 10263
- For right or left hand flange mounting – field convertible
- Mounting dimensions to fit standard flange enclosures 8 inches – 24 inches deep
- Detailed installation instructions
- Superior strength

Flange Handle Construction

- Rugged die cast housing with provisions for locking in OFF position with up to three 3/16-inch to 5/16-inch padlocks
- O-ring seals for dirt-tight/oil-tight duty
- Gusseted, 3/32-inch thick double-sided steel handle with large, red-black self-extinguishing grade plastic grip.

Flange Handle Selection **GO-144A**

Product Number STDA1 (6 inch) and STDA2 (10 inch) flange series handles are interchangeable. While the SE150 through SG600 operating mechanisms can be easily operated with the 6-inch STDA1 handle, the 10-inch STDA2 may be used to obtain lower operating force and/or to provide a proportionally larger handle on large enclosures. STDA3 and STDA3X can be used only with SDOM6 (for SK1200) operating mechanism.

NEMA 12/13 Flange Handle Product Number	List Price	NEMA 4/4X Flange Handle Product Number	List Price	Nominal Length Inches	Installation Instruction Number	Drilling Template Number
STDA1	\$82.50	STDA1X	\$148.00	6	GEH-5314	GEH-5314
STDA2	\$94.50	STDA2X	\$165.00	10		
STDA3	\$94.50	STDA3X	\$165.00	10		

Operating Mechanism Selection **GO-144A**

Circuit Breaker Type	Flange Handle Product Number	Operating Mechanism Product Number	List Price	
SE150	STDA1, 1X (6 inch)	SDOM1A	\$67.00	
SF250		SDOM3	\$76.50	
SG600	STDA2, 2X (10-inch)	SDOM4	\$194.00	
SK1200 ¹	STDA3, 3X	SDOM6 ¹	\$303.00	
TEB, TED, THED, TEC	STDA1, 1X (6 inch) or STDA2, 2X (10-inch)	SDOM1A	\$67.00	
TB1 (150A),		SDOM1A	\$67.00	
TEC with TECL		SDOM1AP	\$15.00	
THLC1 (150A)		TDOM1D	\$252.00	
TEJ, TFK, TFC (225A)		TDOM3 ²	\$76.50	
J-Frames, TJC (400, 600A) ³		TDOM4	\$194.00	
TB4 (400A) TJH/TJL ⁴ (600A Max)		TDOM5	\$265.00	
K-Frames, TKC (800A, 1200A) ⁵ , THLC2 (225A), THLC4 (400A)	TDOM6	TDOM6	\$303.00	
TB6 (600A), TB8 (800A)		TDOM7	TDOM7	\$303.00
TKH/TKLD ⁶ (1200A Max)				

¹Requires STDA3 or STDA3X (10 inch, SK1200 only).

²Not suitable for left hand mounting.

³Includes T/J/THJ/TJL with MicroVersaTrip R trip unit.

⁴Use TDOM5 for TJH/TJL with MicroVersaTrip R RMS-9 trip unit.

⁵Includes TK/TKL with MicroVersaTrip R trip unit.

⁶Use TDOM7 for TKH/TKL with MicroVersaTrip R trip unit.

Flange Stiffener Kit or Extended Length Drive Rod, Product Number TDSR **GO-144A**

Provides rigid 3/8-inch diameter rod between STDA handle mounting surface (flange or center mullion) and operating mechanism when STDA handle would otherwise not be rigidly supported.

Rod length is 22 inches and may be cut to appropriate length. Also used as extended-length drive rod for SDOM1A and SDOM3 when standard 16 inch rod is not long enough. (Operating mechanism Product Number SDOM6 for SK1200 includes two 22" unique 3/8-16x22 inch flange stiffener rods, Product Number TDSR and drive rod.)

Operating Mechanism Product Number	Flange Stiffener Kit Product Number	Extended Drive Rod Product Number	List Price
SDOM1A, SDOM3, TDOM1A through TDOM3	TDSR	TDSR	\$29.50
SDOM4, TDOM4 through TDOM7	TDSR (16" supplied with operating mechanism)	TDSR1	\$28.00

Extended Drive Stud, Product Number TDS1, TDS2 **GO-144A**

This optional drive stud permits locating the operating mechanism 1-5/16 inches farther to the left (When flange handle is on right side) or to the right (when handle is on the left side) to accommodate specific mounting restrictions. Not suitable for use with SDOM4, SDOM6, TDOM4 and TDOM5 operating mechanisms.

Operating Mechanism Product Number	Extended Drive Stud Product Number	List Price
SDOM1A, SDOM3, TDOM1A through TDOM3	TDS1	\$29.50
TDOM6, TDOM7	TDS2	\$29.50

Door Hardware NEMA 12/13 and 4/4X **GO-144A**

Type TDV door hardware provides sealing and interlocking of 3/4-inch nominal door depth hinged on left or right. Interlocking design requires use of screwdriver to release. When used with an STDA flange handle and operating mechanisms, disconnect or circuit breaker cannot be turned on unless door and door hardware have been closed. For noninterlocking type, one bracket in kit is not used. Use of third point latch recommended for doors 40 inches or longer.

Description	Door Hinged on Left Product Number	Door Hinged on Right Product Number	List Price
NEMA 12/13 two point interlocking door hardware kit	TDV1	TDV1L	\$134.00
NEMA 4/4X two point interlocking door hardware kit	TDV1X	TDV1LX	\$174.00
Third point latch kit for above	TDV3	TDV3L	\$29.50



MOLDED CASE CIRCUIT BREAKERS

3

External Accessories

Flange-Mounted Operators

Auxiliary Contact Kits GO-144A

Available SPDT and DPDT and actuated by operating mechanism yoke.

Used With Operating Mechanism Product Number	When STDA handle is on		Auxiliary Contact Kit			
	Right Flange	Left Flange	SPDT		DPDT	
			Product Number	List Price	Product Number	List Price
SDOM1A, SDOM3 SDOM4	•		TDAS1L1	\$71.00	TDAS1L2	\$134.00
TDOM1A, JA TDOM1B, JB TDOM1C TDOM1D TDOM3		•	TDAS1R1	\$71.00	TDAS1R2	\$134.00
SDOM6 TDOM4 TDOM5 TDOM6 TDOM7	•		TDAS2L1	\$71.00	TDAS2L2	\$134.00
		•	TDAS1R1	\$71.00	TDAS1R2	\$134.00

Publication References

Instructions:

Door Hardware	GEH-5322
Auxiliary Contact Kit	GEH-5323
Flange Stiffener Kit or Extended Length Drive Rod	GEH-5324
Extended Drive Stud	GEH-5325

Operating Mechanism:

SDOM1A through SDOM4, SDOM6	GEH-5684
TDOM1A through TDOM1D	GEH-5315
TDOM3	GEH-5317
TDOM4 and TDOM5	GEH-5318
TDOM6 and TDOM7	GEH-5319

See Section 21 for publication ordering information.



External Accessories

Door-Mounted Operators

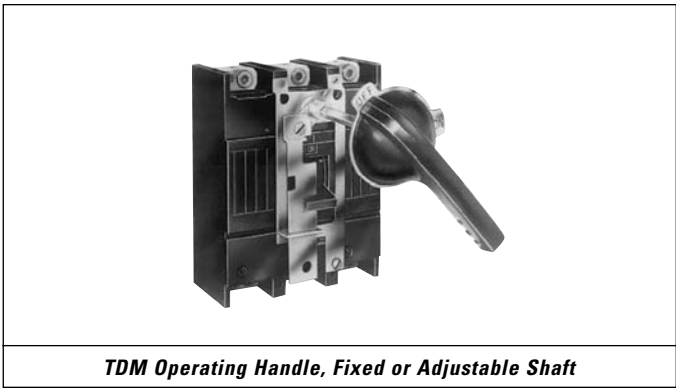

TDM Operating Handle, Fixed or Adjustable Shaft

TDM Handle Operating Mechanisms, Door Mounted

GO-144A

Complete mechanism with handle UL listed, E-57253

Operating mechanism only, UL Component Recognized, E-57253

Breaker Type	Box Depth in Inches	Complete Mechanism ¹ with NEMA 1, 3R, 12 Handle		Operating Mechanism Only		Handle Only			
		Product Number	List Price	Product Number	List Price	NEMA 1, 3R, 12		NEMA 4/4X	
						Product Number	List Price	Product Number	List Price
TQD, THQD	Shallow Mount 3 7/16	TQDHM1	\$69.00	TQDOM1	\$42.00				
	Extended Shaft 4 5/16 - 14 5/16	TQDHM2	\$82.00	TQDOM2 ²	\$55.00				
TEB, TEC, TB1, TED, THED	Shallow Mount 4 3/16	TEFHM1	\$69.00	TEFOM1	\$42.00				
	Extended Shaft 5-1/8 - 5 7/32	TEFHM3	\$82.00	TEFOM3	\$55.00	TH1	\$27.00		
	5 1/8 - 5 13/16	TEFHM4	\$82.00	TEFOM4	\$55.00				
	5 1/8 - 15	TEFHM2	\$82.00	TEFOM2	\$55.00				
TFC, TFJ, TFK, THFK	Shallow Mount 5 7/8	TFKHM1	\$103.50	TFKOM1	\$76.50			THCH45 ^{3,4}	\$303.00
	Extended Shaft 6 7/8 - 15 1/2	TFKHM2	\$107.50	TFKOM2 ²	\$80.50				
TJC, TJD, TJJ, TJK, THJK, TB4, TBC4	Shallow Mount 5 7/8	TJKHM1	\$143.00	TJKOM1	\$102.00				
	Extended Shaft 5 5/8 - 15 5/8	TJKHM2	\$147.00	TJKOM2 ⁴	\$106.00				
TKC, TKM, THKM, TB6, TBC6, TB8, TBC8	Shallow Mount 7 7/16	TKMHM1	\$143.00	TKMOM1	\$102.00				
	Extended Shaft 7 1/32 - 17 5/16	TKMHM2	\$147.00	TKMOM2 ⁴	\$106.00	TH2	\$41.00		
TJ4V, TJL	Shallow	TJVHM1	\$143.00	TJVOM1	\$102.00				
	Extended	TJVHM2	\$147.50	TJVOM2	\$106.00				
TK4V, TKL	Shallow	TKVHM1	\$143.00	TKVOM1	\$102.00				
	Extended	TKVHM2	\$147.00	TKVOM2	\$106.00				
SE150 (GEH-5611) ⁵	4 3/16	SEFHM1	\$79.00	SEFOM1	\$52.00				
	6 1/8 - 15	SEFHM2	\$81.50	SEFOM2 ²	\$55.00	TH1	\$7.00		
SF250 (GEH-5611) ⁵	5 7/8	SEFHM1	\$79.00	SEFOM1	\$52.00				
	7 3/4 - 15 1/2	SEFHM2	\$81.50	SEFOM2 ²	\$55.00			THCH45 ^{3,4}	\$303.00
SG600 (GEH-5653) ⁵	5 7/8	SGHM1	\$143.00	SGOM1	\$102.00				
	5 5/8 - 15 5/8	SGHM2	\$147.00	SGOM2 ⁴	\$106.00	TH2	\$41.00		
SK1200 (GEH-5612) ⁵	6	SKHM1	\$143.00	SKOM1	\$102.00				
	7	SKHM2	\$147.00	SKOM2 ⁴	\$106.00				

¹Handle assembly and operating mechanism separately packaged.

²For 15-inch long shaft order Product Number 788A831G10, List Price, \$40.00, GO-135B. For 20-inch long shaft order Product Number 788A831G21 List Price \$40.00, GO-135B.

³Provides interlocking for J600, SG600 SK1200, and K1200 breakers when used with the extended shaft operating mechanism. For interlocking with E150/SE150, F225 and SF250 order special shaft Product Number 788A832G1, List Price, \$40.00, GO-135B.

⁴For 15-inch long shaft order Product Number 788A832G2, List Price \$40.00, GO-135B. For 20-inch long shaft order Product Number 788A832G5, List Price \$40.00, GO-135B.

⁵Installation instructions publication number.

⁶MOD 1 is 7 7/16; MOD 2 is 8 3/32.

⁷MOD 1 is 7 3/16 - 17 3/16; MOD 2 is 7 15/16 - 17 15/16.

Handle Accessories for TDM Operating Mechanisms GO-139

Device	Product Number	List Price
Replacement neoprene gaskets for NEMA 1, 3R and 12 enclosures		
Use with TH1	788A742P3	\$2.80
Use with TH2	788A742P4	\$6.10



MOLDED CASE CIRCUIT BREAKERS

3

External Accessories
Door-Mounted Operators

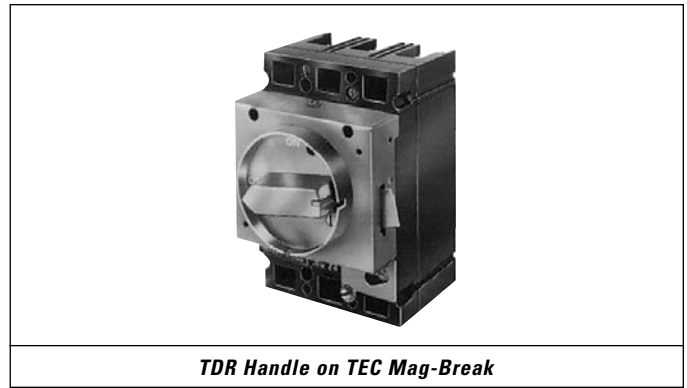

TDR Handle on TEC Mag-Break

TDR Integral Handle Mechanism¹ Suitable for NEMA 12 Applications² GO-144

Breaker Type	Handle		List Price	Ship Weight	Door Ring - Interlock Catch Kit		NEMA 12 Gasket Kit	
	Vertical Mounting Product Number	Horizontal Mounting Product Number			Product Number	List Price	Product Number	List Price
TEB, TEC, TB1-B, TED, THED	TEFR1B	TEFR1HB	\$65.50	17 ³	SEFRDRCK	\$11.25		
THLC1	TLC1RB	TLC1RHB	\$65.50	17 ³	-	-	SEFRGSK	\$4.00
TFC, TFJ, TFK, THFK	TFKR1B	TFKR1HB	\$78.50	22 ³	343L483G5	\$11.25		
THLC2, 4; TLB4	TLC4RB	TLC4RHB	\$78.50	3	343L483G9	\$11.25		
TJD, TJC, TJJ, TJK, THJK, TB4, TBC4	TJR1B	TJR1HB	\$78.50	5	343L483G2	\$20.25	SGRGSK	\$11.00
TKC, TKM, THKM, TB6, TB8, TBC6, TBC8	TKMR1B	TKMR1HB	\$128.00	5	SKRDRCK	\$21.75	SKRGSK	\$11.00
TJ4V, TJL	TJVR1B	TJVR1HB	\$78.50	5	343L483G7	\$20.25	SGRGSK	\$11.00
	TJVR1BKLP ⁴	TJVR1HBKLP ⁴	\$524.00					
TKL	TKVR1B	TKVR1HB	\$128.00	5	343L483G8	\$21.75	SKRGSK	\$11.00
	TKVR1BKLP ⁴	TKVR1HBKLP ⁴	\$572.00					
SE150, SF250 (GEH-5609) ⁶	SEFR1 ⁵	SEFR1H ⁵	\$65.50	17 ³	SEFRDRCK	\$11.25	SEFRGSK	\$4.00
SG600 (GEH-5654) ⁶	SGR1	SGR1H	\$78.50	5	SGRDRCK	\$20.25	SGRGSK	\$11.00
SK1200 (GEH-5610) ⁶	SKR1	SKR1H	\$128.00	5	SKRDRCK	\$21.75	SKRGSK	\$11.00

¹Not suitable for use with mine duty or heavy duty UVR breakers.

²Requires Gasket kit.

³Shipped 12 per pack.

⁴With provision for Kirk Key Interlock. Lock supplied by customer (type FN with one-inch bolt projection - bolt extended, key removable with breaker open).

⁵For F250 Frame also order adapter bracket, Product Number SFRAK, no charge when ordered with handle.

⁶Installation instructions publication number. See Section 21 for publication ordering information.

External Accessories

Motor Operators and Plug-in Hardware

Motor Mounted Mechanism GO-135S

UL Listed

Breaker Type	Voltage		Product Number	List Price	Installation Instructions
	Vac 50/60 Hz	Vdc			
TEB, ¹ TEC, TED, ¹ THED, TB1, THLC ^{1,2}	-	24	TEDMOMA8	\$1572.00 ⁶	-
	120 ³	-	TEDMOMA1	\$710.00 ⁶	
	240 ^{4,5}	-	TEDMOMA2	\$710.00 ⁶	
TFC, TFJ, TFK, THFK	-	24	TFKMOMA8	\$1692.00 ⁶	-
	-	48	TFKMOMA9	\$1692.00 ⁶	
	120	125	TFKMOMA1	\$1692.00 ⁶	
	240 ^{4,5}	250	TFKMOMA2	\$1692.00 ⁶	
TJC, TJJ, TJD, TJK, THJK, TB4, TBC4	-	24	TJKMOMA8	\$2160.00 ⁶	-
	-	48	TJKMOMA9	\$2160.00 ⁶	
	120	125	TJKMOMA1	\$2160.00 ⁶	
	240 ^{4,5}	250	TJKMOMA2	\$2160.00 ⁶	
TKC, TKM, THKM, TB6, TB8, TBC6, TBC8	-	24	TKMMOMA8	\$2340.00 ⁶	-
	-	48	TKMMOMA9	\$2340.00 ⁶	
	120	125	TKMMOMA1	\$2340.00 ⁶	
	240 ^{4,5}	250	TKMMOMA2	\$2340.00 ⁶	
SE150	120	125	SEMOM1	\$710.00	GEH-5613
	240 ⁴	-	SEMOM2	\$710.00	
	-	24	SEMOM8	\$710.00	
	-	48	SEMOM9	\$710.00	
SF250	120	125	SFMOM1	\$1692.00	GEH-5613
	240 ⁴	-	SFMOM2	\$1692.00	
	-	24	SFMOM8	\$1692.00	
	-	48	SFMOM9	\$1692.00	
SG600	120	125	SGMOM1	\$2160.00	GEH-5657
	240 ⁴	250	SGMOM2	\$2160.00	
	-	24	SGMOM8	\$2160.00	
	-	48	SGMOM9	\$2160.00	
SK1200	120	125	SKMOM1	\$2340.00	GEH-5614
	240 ⁴	250	SKMOM2	\$2340.00	
	-	24	SKMOM8	\$2340.00	
	-	48	SKMOM9	\$2340.00	

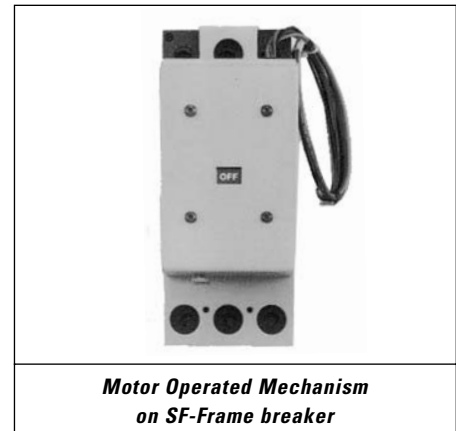

For TJ4V, TJL, TKL, TK4V ONLY ⁷ GO-135B

Breaker Type	Volts	Mechanism Product Number	Mounting Plate Product Number	List Price
TJ4V, TJL	120 Vac 125 Vdc	TJKMOMA1	286A7558G8	\$2160.00
	240 Vac ^{4,5} 250 Vdc	TJKMOMA2	286A7558G8	\$2160.00
	24 Vdc	TJKMOMA8	286A7558G8	\$2160.00
	48 Vdc	TJKMOMA9	286A7558G8	\$2160.00
	120 Vac 125 Vdc	TKMMOMA1	286A7558G7	\$2340.00
TKL, TK4V	240 Vac ^{4,5} 250 Vdc	TKMMOMA2	286A7558G7	\$2340.00
	24 Vdc	TKMMOMA8	286A7558G7	\$2340.00
	48 V	TKMMOMA9	286A7558G7	\$2340.00

Mounting Screw Kit for Motor-Operated Mechanism ⁸ GO-148B

Breaker Type	Mounting Screw Kit Product Number	List Price
TED, TB1	343L564G7	\$33.50 ⁶
TFJ, TFK	343L564G1	\$8.70 ⁶
TJJ, TJK, TB4	343L564G2	\$87.00
SG600	SGMSKMOM	\$87.00 ⁹
TKM, TB6, TB8, SK	343L564G3	\$121.00

Mounting Screw Kit for TDR Integral Handle GO-135B

Breaker Type	Mounting Screw Kit Product Number	List Price
TFC, TFJ, TFK	343L564G4	\$8.60
TEC, TED, TB1-B, TJC, TJJ, TJK, TB4, TBC, TKC, TKM, TB6, TB8, TBC6, TBC8	No Special Mounting Screw Required	

¹For use on 3-pole breaker only.

²Motor-operated mechanisms must have Code Date 506 + or later for use with THLC1.

³TEDMOMA1 not rated at 50 hertz.

⁴Suitable for use at 208 Vac.

⁵Not UL listed.

⁶GO-135B.

⁷Requires mounting plate which is supplied at no charge when ordered with mechanism. Order both items.

⁸Required with plug-in mounting base assembly when used with motor-operating mechanisms or TDR integral-handle kits. Furnished no charge when ordered with mounting base.

⁹GO-135S.

MOLDED CASE CIRCUIT BREAKERS

3



External Accessories

Mechanical Interlocks and Locking Devices

Mechanical Interlocks

Walking Beam Type Externally Mounted—UL Component Recognized

Breaker Type	Panel Thickness in Inches	Requires Breaker with Special Factory Drilling. Order 2 Breakers per Interlock, Specifying "Drilled for Mech. Interlock" Product Number	List Price GO-135B
E-150, TB1	.25-1.0	TEDMI	\$341.00
F225	.25-1.0	TFKMI	\$341.00
TJJ, TJK, TJ4V, THJ4V, TB4	0.38	TJKMIB	\$341.00
	1.0	TJKMIE	\$341.00
TKM, TK4V, TB6, TB8	.75-1.0	TKMMI	\$341.00 ¹

These face-mounted interlocks prevent two adjacent breakers from being in the ON position at the same time.

Spectra RMS Breaker Type	Face-mounted Interlock Product Number	List Price GO-135S	Adapter Kit Required when using handle operator (TDM) or motor operator. Order separately.	List Price GO-135S
SE150, SF250	SEFFMI	\$341.00	SEFFMIAK ²	\$33.50
SG600	SGFMI	\$683.00	SGFMIAK ³	\$42.00
SK1200	SKFMI	\$683.00	SKFMIAK	\$59.50

Handle-Locking, Handle-Extension Devices GO-135B

Breaker Type	Device	Product Number	List Price
TQB, TQC, TQL	Handle locking	THL103	\$6.50 ⁴
TQB, TQC, TQL	Snap-on handle tie - trip indicating	TQHT1	\$2.30 ⁴
TQL	Snap-on handle tie - solid	THT104	\$2.30 ⁴
TEY	Handle locking	TEYLD1	\$5.00
E150 Line	Handle locking	TLD3	\$5.00
F225 Line, THLC2, 4	Handle locking	TFKLD1	\$6.00
SE150, SF250	Handle locking	SBD1	\$4.70 ⁵
SK1200	Handle extension - replacement	SKHDLEXT	\$96.50 ⁵

Q Line, TEY Mounting Accessories GO-135B

Description	Breaker Type	Product Number	List Price
Back Mounting plates	1-pole THQC	TQCBMPA1	\$8.30
Screw Type	2-pole THQC	TQCBMPA2	\$9.80
THQC Breaker held to Mounting Plate by screw clip	3-pole THQC	TQCBMPA3	\$12.00
Snap In	10-pole THQC	TQCBMPA10	\$32.00
THQC, THQC-GF snaps in to spring retaining clip	1-pole	TQCGFBMPA1	\$6.10 ⁶
	2-pole	TQCGFBMPA2	\$7.60 ⁶
	3-pole	TQCGFBMPA3	\$9.10 ⁶
	10-pole	TQCGFBMPA10	\$25.00 ⁶
Bolt-on Base for THQB, TEY	3-pole	TEY3B	\$31.50
	1-pole THQC	TQCFMP1	\$8.30
	2-pole THQC	TQCFMP2	\$9.80
Front-mounting Plates ⁷	3-pole THQC	TQCFMP3	\$12.00
	10-pole THQC	TQCFMP10	\$14.00
3-pole Plug-in Mounting Base (70 Amp)	3-pole TQL	571B595DDG2	\$32.00 ⁸
2-pole Plug-in Mounting Base (70 Amp)	2-pole TQL	571B595DDG1	\$23.75 ⁸
3-pole Plug-in Mounting Base (100 Amp)	3-pole TQL	565B837G1	\$38.00 ⁸
2-pole Plug-in Mounting Base (100 Amp)	2-pole TQL	565B837G2	\$23.75 ⁸
Pack of 48 Front/Rear Mounting Clips	1 & 2-pole 15-60A THQC	THQCFMK	\$48.00 ⁹
Pack of 24 DIN rail clips	DIN rail THQC	THQCIN	\$24.00 ⁹

¹GO-144.

²Not suitable with THCH45 handle.

³Compatible with motor operator only. Product Number SGFMI cannot be used with the handle operator.

⁴GO-137A.

⁵GO-135S.

⁶GO-133.

⁷Not UL listed.

⁸GO-134A.

⁹Price is per pack.

¹⁰Suitable for circuit breakers used in group mounted panelboard construction only except for J600, K1200, SE150/SF250, SG600 and SK1200 which screw down to face of breaker.

¹¹Field installable.

Standard Padlocking Devices¹⁰

GO-135B

Breaker Type	Device Product Number	List Price
TQC	TQPLD1	\$4.70
TQD	TQDPLD1	\$20.75 ⁴
TQDL	TQDPLD1	\$17.75 ⁴
TQB, TQL	THP100	\$6.50 ⁴
TEY	TEYPLD1	\$9.00
E150, TB1	TEFPLD1	\$8.00
THLC1	TLC1PLD1	\$17.00
F225	TFKPLD1	\$4.00
THLC2, THLC4, TLB4	TLC4PLD1	\$22.00
J600 Line	TJKPLD1	\$8.00
K1200 Line	TKMPLD1	\$28.50
SE150, SF250	SEPLD	\$8.70 ⁵
SG600	SGPLD	\$15.00 ⁵
SK1200	SKPLD	\$28.50 ⁵

EUSERC Approved—Factory Installed Only

GO-135B

Breaker Type	Product Number	List Price
TQD	TQDPLD2	\$32.00
E150	TEFPLD2	\$32.00
SE150, SF250 ¹¹	SEFPLD2	\$32.00 ⁵
SG600	SGPLD2	\$48.00 ⁵
J600	TJKPLD2	\$48.00
SK1200	SKPLD2	\$60.00 ⁵
THLC1	THLC1PLD2	\$48.00
THLC2/4	THLC4PLD2	\$48.00

PowerMark Gold Main Circuit Breaker Kit

GO-138M

Description	Product Number	List Price
Order appropriate THQL (10 kAIC) or THHQL breakers separately.	TQMHO00	\$10.50

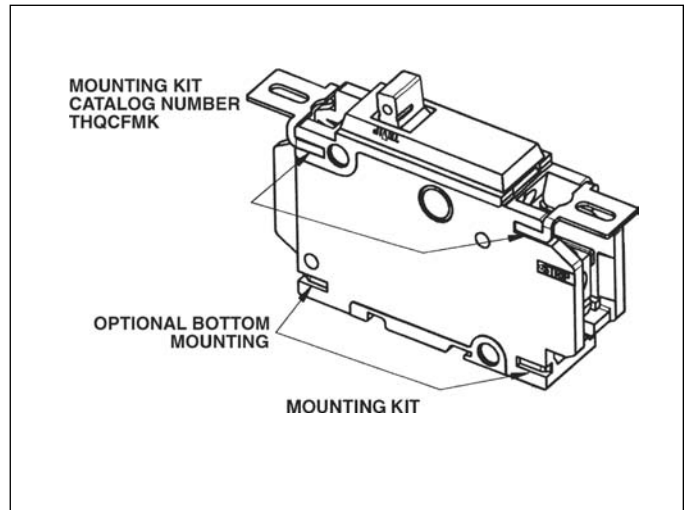

MOLDED CASE CIRCUIT BREAKERS 3

Publications and Reference: See Section 21 for a list of additional product-related publications

External Accessories

Breaker Mounting Hardware and Kits

Breaker Mounting Screw Kits GO-135S

Application	Spectra RMS Breaker Type	Kit Product Number	Screw Size (inches)	List Price
For use on mounting plates with tapped holes (4 screws and lockwashers)	SE150	SEMSK1	10-33x2 7/8 (std.)	\$2.10
		SEMSK3	8-32x2 7/8 (opt.)	\$2.10
	SF250	SFGMSK1	12-24x3 3/4 (std.)	\$6.10
		SFMSK1	10-32x3 3/4 (opt.)	\$6.10
	SG600	SFGMSK1	12-24x3 3/4	\$6.10
SK1200	SKMSK1	5/16-18x1 1/4	\$8.70	
For use on mounting plates with clearance holes (4 screws, lockwashers and nuts)	SE150	SEMSK2	10-32x3 (std.)	\$2.10
		SEMSK4	8-32x3 (opt.)	\$2.10
	SF250	SFGMSK2	12-24x4 (std.)	\$6.10
		SFMSK2	10-32x4 (opt.)	\$6.10
	SG600	SFGMSK2	12-24x4	\$6.10
SK1200	SKMSK2	5/16-18x1 3/4	\$8.70	

Breaker Mounting Screw Kits GO-135B

Application	Breaker Type	Product Number	List Price
For use on mounting plates with clearance holes	1-pole E150	343L162G1	\$0.85
	2- and 3-pole E150	SEMSK4	\$2.10 ¹
	THLC1	343L162G22	\$2.10
	F225	SFGMSK2	\$6.10 ¹
	THLC2, 4, TLB4	343L162G24	\$5.70
	J600	343L162G20	\$4.50
	K1200	SKMSK2	\$8.70 ¹
For use on mounting plates with tapped holes	1-pole TE, E150	343L162G7	\$0.85
	2- and 3-pole E150	SEMSK3	\$2.10 ¹
	THLC1	343L162G23	\$2.10
	2- and 3-pole TQD/THQD	343L184G18	\$4.40 ²
	F225	SFGMSK1	\$6.10 ¹
	THLC2, 4, TLB4	343L162G25	\$5.70
	J600	343L162G11	\$4.50
K1200	SKMSK1	\$8.70 ¹	
24 mounting screws for connecting low tab to panel board	THQB	TQBS1 (packaged 24/kit)	\$6.00 ³
Cup washer (for mounting 1-pole breakers)	E150	254V644P1 (2 req'd per breaker)	\$0.10

Back-Connected Line and Load Studs GO-135B

Breaker Type	Amperes	Length, Back of Breaker in Inches	Std Pkg	Product Number	List Price
E150 ⁴ , TB1 ⁴ , THLC1 ⁴	50	2 25/32 (short)	1	TEF1	\$27.00
		4 13/32 (long)	1	TEF2	\$27.00
TFJ ⁴ , TFK ⁴ , THFK ⁴	150	3 13/32 (short)	1	TEF3	\$28.00
		5 25/32 (long)	1	TEF4	\$31.50
J600, TJ4V, TB4, TJL	225	2 23/32 (short)	1	TFK1	\$38.50
		5 31/32 (long)	1	TFK2	\$59.50
K1200, TB6, TB8	400	5 17/32	1	TJK1	\$83.50
		5 17/32	1	TJK2	\$119.00
SE150	600	5 1/2	2	TKM11	\$220.00
		8	2	TKM12	\$242.00
SF250	1200	2 25/32 (short)	1	TEF1	\$27.00
		4 13/32 (long)	1	TEF2	\$27.00
SG600	150	3 13/32 (short)	1	TEF3	\$28.00
		5 25/32 (long)	1	TEF4	\$31.50
SK1200	250	2 23/32 (short)	1	TFK1	\$38.50
		5 31/32 (long)	1	TFK2	\$59.50
24 mounting screws for connecting low tab to panel board	600	2 13/16 (short)	2	SGBCS1	\$119.00 ¹
		6 1/16 (long)	2	SGBCS2	\$119.00 ¹
Cup washer (for mounting 1-pole breakers)	1200	5 1/2	2	TKM11	\$220.00
		8	2	TKM12	\$242.00

Back-Connected Center Studs

for Dual Voltage Applications GO-135B

3-pole only. Order frame and trip unit separately. Not UL listed. Breaker frame can be supplied with center stud connections permitting operation at both voltages with one trip unit rating. At the higher voltage, connection is made at the line and load terminals only and thus the trip unit carries all the load current. At the lower voltage, where current is double, connection is also made through the center studs permitting half the current to bypass the trip unit. At either voltage, full-load current is carried by the breaker contacts.

Maximum Frame Ampere Rating	Trip Unit Maximum Ampere Rating	Dual Voltage Frame Only Product Number	List Price ⁵
225A	110	TFK236F000DV	\$1244.00
400A	200	TJK436F000DV	\$2364.00
600A	300	TJK636F000DV	\$2576.00
800A	400	TKM836F000DV	\$3095.00
1200A	600	TKM3FDV	\$4064.00

¹GO-135S.

²GO148C.

³Price is per screw. Packaged in quantity of 24. Must be ordered in multiples of 24.

⁴For proper clearance between poles, a short and long stud must be assembled adjacent to each other.

⁵Price includes center studs, but does not include line and load back-connected studs or trip unit.

MOLDED CASE CIRCUIT BREAKERS

3



External Accessories
Lugs and Associated Hardware

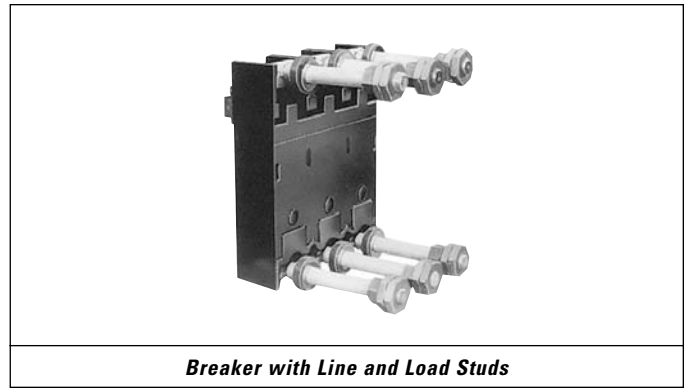

Breaker with Line and Load Studs

Lugs, Line Shields, Covers and Bus Connectors

GO-135B

Accessory	Wire Size	For Use With	Product Number	List Price
Copper-Aluminum Lugs	#14-6 Cu, #12-2 Al	TQC (15-60A) (Non DIN Rail)	TOAL3	\$1.50
	#4-1/0 Cu-Al	TQC (70-100A)	TOAL4	\$1.50
	#1-300 kcmil Cu-Al	TQD	TCAL25	\$8.00 ¹
	#14-8	E150, THLC1, TB1, (15-30A)	TCAL14	\$3.00
	#14-3 Cu, #12-1 Al	E150, THLC1, TB1, (15-60A)	TCAL12	\$3.00
	#6-2/0 Cu, #4-2/0 Al	E150, THLC1, TB1, (70-90A)	TCAL12A	\$3.00
	#3-3/0 Cu, #1-3/0 Al	E150, THLC1, TB1, (100-150A)	TCAL15	\$3.00
	#4-300kcmil Cu-Al	F225	TCAL24	\$8.00
	#4-300kcmil Cu-Al	THLC2	TCAL27	\$10.00
	(1) 6-600kcmil or (2) 2/0-250kcmil Cu-Al	J400, TB4, J600 (Thru 400A), TJD	TCAL43	\$14.00
	(2) 4/0-350kcmil Cu or (2) 300-500kcmil Al	J600 (450-600A)	TCAL63	\$23.00
	(1) 750 kcmil Cu-Al	J400, TJD	TCAL47	\$26.00
	(1) 3/0-500kcmil or (2)3/0-250kcmil Cu-Al	TLB4, THLC4	TCLK43	\$49.00
	(2) 1/0-250kcmil or (1) #4-600 kcmil Cu-Al	K1200, TB6 (300-400A)	TCAL41	\$38.00
	(2) 2/0-500 kcmil Cu-Al	K1200, TB6, (500-600A)	TCAL61	\$40.00
	(3) 3/0-500 kcmil Cu-Al	K1200 (700-1000A), TB8	TCAL81 ²	\$47.00 ³
	(3) 3/0-500 kcmil Cu-Al	TK4V - Load end	TCAL91 ²	\$47.00 ³
	(4) 250-350 kcmil Cu or (4) 250-500 kcmil Al	K1200 (1200A)	TCAL121 ⁴	\$76.00 ³
	(4) 250-350 kcmil Cu or (4) 250-500 kcmil Al	TK4V - Load end	TCAL122	\$103.00 ⁵
	(4) 250-350 kcmil Cu or (4) 250-500 kcmil Al	TK4V - Load end	TCAL131 ⁴	\$76.00 ³
Copper Only Lugs With Follower and Extra Plating	#14-2/0	E150, TB1 (thru 150A)	TC012	\$6.00
	(1) 6-600 kcmil or (2) 1/0-250 kcmil Cu	J400, TB4	TC043	\$21.00
	(2) 250-350 kcmil Cu	J600	TC063	\$34.00
	(1) 1/0-600kcmil or (2) 1/0-250 kcmil Cu	K1200, TB6 (300-400A)	TC041 ⁵	\$38.00
	(2) 2/0-500 kcmil Cu	K1200, TB6, (500-600A)	TC061	\$40.00
	(3) 3/0-500 kcmil Cu	K1200 (700-1000A), TB8	TC081A	\$53.00 ³
	(3) 3/0-500 kcmil Cu	TK4V - Load end	TC091	\$53.00 ³
	(4) 250-400kcmil Cu	K1200 (1200A)	TC0121	\$80.00 ³
	(4) 250-400kcmil Cu	TK4V - Load end	TC0131	\$80.00 ³
	Line Shield		TEB, TEC, TED, THED	TEDLS
		TFJ, TFK, TFC	TFKLS	\$16.25
		TJJ, TJK, TJC	TJKLS	\$14.25
		TC041, TCAL41 Lugs	789A448G3 ⁶	\$35.00
Lug Cover, TKM Breaker (two per breaker)		TC061, TCAL61, TCAL81 Lugs, TC081A	789A448G1	\$35.00
		TC0121; TCAL121 Lugs	789A448G2	\$35.00
		TH4V, THK9V	286A8066G1	\$33.50 ³
Connector (back strap)		TKM	TKMC1	\$38.00
Line voltage control wire kit for terminating control wire at breaker lugs		J600	TJLVK ⁷	\$9.00
		K1200	SKLVK ⁷	\$12.00 ³

¹GO-135F.

²Not suitable for 100 A aluminum conductor.

³GO-135S.

⁴Suitable for 500 kcmil copper for voltage drop considerations.

⁵Not UL listed.

⁶End cover supplied with 800A frame is used as lug cover.

⁷3-pole kit.

www.DataSheet4U.com

Publications and Reference: See Section 21 for a list of additional product-related publications



www.DataSheet4U.com

MOLDED CASE
CIRCUIT BREAKERS
3

External Accessories

Lugs and Associated Hardware

Spectra RMS Lugs, Lug Covers, and Bus Lugs

GO-135S

Accessory	For Use With	Wire Range (Qty.)		Product Number	Description	Ampacity Range ¹	List Price
		Copper	Aluminum				
Plated extruded aluminum lugs for terminating copper or aluminum cables	SE150	#12-3/0	#12-3/0	TCAL18	Single lug	15-150	\$3.00
	SF250	#8-350 kcmil	#8-350 kcmil	TCAL29	Single lug	70-250	\$8.00
	SG600	(2)2/0-500 kcmil or (1)#8-600 kcmil	(2)2/0-500 kcmil or (1)#8-600 kcmil	TCLK265	2-pole lug kit ²	125-600	\$28.00
				TCLK365	3-pole lug kit ²	125-600	\$42.00
	SK1200	(3)300-750 kcmil (3)3/0-500 kcmil (4)250-350 ³ kcmil	(3)300-750 kcmil (3)3/0-500 kcmil (4)250-500 kcmil	TCAL124	Single lug	Cu 275-1200 Al 225-1100	\$103.00
				TCAL81	Single lug	300-800	\$47.00
TCAL125 ³				Single lug	600-1200	\$76.00	
Replacement Lug Covers and End Covers	SE150	-	-	SE3LCK	Three lug covers for upper (line) end	-	\$5.10
	SF250	-	-	SF3LCK	Three lug covers for upper (line) end	-	\$9.80
	SG600	-	-	SG1LCK	3-pole lug cover for upper (line) or lower (load) end	-	\$21.25
				SG1BCK	3-pole lug cover for upper (line) or lower (load) end ⁷	-	\$37.00
	SK1200	-	-	SK1LCK	Lug cover for upper (line) or lower (load) end ⁴	-	\$33.50
Plated Copper Lugs	SE150	#12-3/0	-	TCO18	Single lug	15-150	\$6.00
	SF250	#8-350 kcmil	-	TCO19	Single lug	70-250	\$21.25
	SG600	(2)2/0-500 kcmil or (1)#8-600 kcmil	-	TCOK265	2-pole lug kit	125-600	\$42.00
				TCOK365	3-pole lug kit	125-600	\$63.00
	SK1200	(3)250-500 kcmil (4)250-400 kcmil (3)250-750 kcmil	-	TCO81A	Single lug	300-800	\$53.00
				TCO121	Single lug	600-1200	\$80.00
TCO124	Single lug	600-1200	\$155.00				
Line voltage control wire kit for terminating control wire at breaker lugs	SE150	#12-3/0	#12-3/0	TCAL18LV	Single lug with .25 Quick Connect	15-150	\$6.60
	SF250	#8-350 kcmil	#8-350 kcmil	TCAL29LV	for Control Voltage	70-250	\$17.75
	SG600	-	-	SGLVK	3-pole kit	-	\$9.00
	SK1200	-	-	SKLVK	3-pole kit	-	\$12.00
Clear rating plug cover with provision for wire seal	SG600 / SK1200	-	-	SPCOV1	Replacement cover for MicroVersaTrip Plus and MicroVersaTrip PM	-	\$13.25
				SPCOV2	Cover with access to instantaneous set point	-	\$13.25
				SPCOV3	Cover with no access to instantaneous set point	-	\$13.25

Lugs and Lug Covers for J and K Frames with MVT-4 and RMS-9 Trip Units

GO-135S

Breaker Type	Sensor Rating (Amps)	Standard Lugs		Optional Lugs		Lug Covers ⁵		End Covers ⁵									
		Cu/Al Product Number	List Price	Cu Only Product Number	List Price	Product Number	List Price	Product Number	List Price								
TJ, TJL with RMS-9 or MVT-4	150	TCAL43	\$14.00 ⁶	TCO43	\$21.00 ⁶	-	-	-	-								
	200																
	300	TCAL63	\$23.00 ⁶	TCO63	\$34.00 ⁶	-	-	-	-								
	400																
TKH, TKL with RMS-9	500	TCAL81	\$47.00	TCO81A	\$53.00	286A8066G3	\$33.50	286A8066G2	\$33.50								
	600																
	800																
K with MVT-4 TRIP UNIT	1000	TCAL121 ³	\$76.00	TCO121	\$80.00	286A8066G1	\$33.50	286A8066G2	\$33.50								
	1200																
	400									TCAL81-Line ³	\$47.00	TCO81A-Line	\$53.00	286A8066G3	\$33.50	286A8066G2	\$33.50
	600									TCAL91-Load ³	\$47.00	TCO91-Load	\$53.00	286A8066G3	\$33.50	286A8066G2	\$33.50
	800	TCAL121-Line ³	\$76.00	TCO121-Line	\$80.00	286A8066G1	\$33.50	286A8066G2	\$33.50								
	1000	TCAL131-Load ³	\$76.00	TCO131-Load	\$80.00												
	1200																

¹Both copper and aluminum cables may not cover full ampacity range.

²With lug cover for line or load end.

³500 kcmil acceptable for voltage drop considerations.

⁴100kA, 480 Vac (SKPA) uses longer lug cover/arc shield on upper end. Use Product Number SKPSHLD for replacement. May be used on other SK1200 devices.

⁵Breakers supplied less lugs with end covers. When ordering K-frame breaker and lugs, order appropriate lug covers.

⁶GO-135B.

⁷Required for line end bus connection.

MOLDED CASE CIRCUIT BREAKERS

3



External Accessories

Neutral Grounds and Sensors

Power Distribution Lugs GO-135

Breaker Type	Max Amperes	Wire Range	Product Number	List Price
SE, TED	125	(2) 4-14 or (1) 2/0-4 Cu only	TCAL19PD3	\$50.00
SF	250	(6) 4-14 Cu only	TCAL28PD3	\$75.00
SG	400	(12) 4-14 Cu only	TCAL40PD3	\$88.00

Neutral Current Sensors GO-135S

For grounded neutral system ground fault applications

Breaker Type	Ampere Rating	Product Number	List Price
J	150	TSRG201	\$532.00
	200	TSRG202	\$532.00
	300	TSRG203	\$532.00
	400	TSRG204	\$532.00
	500	TSRG205	\$532.00
	600	TSRG206	\$532.00
K	800	TSKG408	\$532.00
	1000	TSKG410	\$532.00
	1200	TSKG412	\$532.00

Fungus and Moisture Proofing GO-135B

Poles	Q Line	E150	F225	J600	K1200	TB-1	TB-4	TB-6, 8
	List Price	List Price	List Price	List Price	List Price	List Price	List Price	List Price
1, 2	\$8.90	\$28.50	\$84.00	\$84.00	\$216.00	\$62.50	\$231.00	\$295.00
and 3	\$22.25	\$62.50						

Test Set for MicroVersaTrip Plus, MicroVersaTrip PM and MicroVersaTrip RMS-9 Trip Units GO-245B

Description	Product Number	List Price
Portable Test Set	TVRMS2	\$3000.00

Rating Plug Removal Tool GO-135S

Product Number	List Price
TRTOOL	\$12.00

"Naval Use" Molded Case Circuit Breakers

The following molded case circuit breaker types are optionally available as UL listed per Standard 489, Supplement SB for naval use:

- THQB
- THQC
- SE150
- SF250
- SG600
- SK1200

Contact GE sales office for price and delivery.

Special Calibration

Contact GE sales office for availability. May void UL listing status.



Power Distribution Lugs

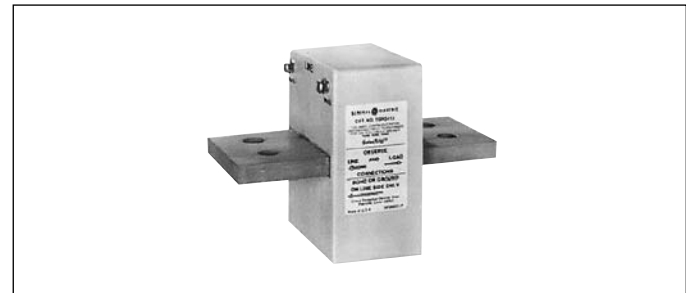

Neutral Current Sensor

www.DataSheet4U.com

Publications and Reference: See Section 21 for a list of additional product-related publications



External Accessories

Plug-in Hardware

Each plug-in mounting base assembly includes all mounting hardware, studs, and male or female connectors for attachment to one end of breaker. Studs are of different length so by using proper combinations of PD1 and PD2 units, adequate electrical spacing will be assured between adjacent breakers, i.e., a short-long-short (SLS) unit must be used adjacent to a long-short-long (LSL) unit. Two-pole breakers of the E150 line require an open-long-short (OLS) unit on one end of the breaker and a short-long-open (SLO) on the other since these breakers are built with the normal left pole missing while the mounting bases are built from standard three-pole molded supports.

Spectra RMS and all other two-pole breakers are basically three-pole devices with the center pole omitted. When these breakers are to be mounted side by side, a short-open-short (SOS) unit must be used on one end and a long-open-long (LOL) on the other. Horizontal studs are normally supplied with the flat surface of studs at right angles to the long axis of the breaker. If vertical studs are desired, substitute "C" for "D" in the product number, e.g., TE13PC1 (vertical) or TE13PD1 (horizontal).

The optional mounting plate (TMP1, etc.) accurately locates and supports the pair of line and load plug-in mounting-base assemblies and provides a convenient means to attach the entire unit to a metal structure, and serves as a dead front barrier. New drawings are available for customers who prefer to fabricate their own mounting plates.

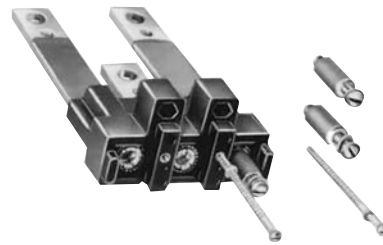

Plug-in Mounting Base with Hardware
Product Number TF23PD2 shown

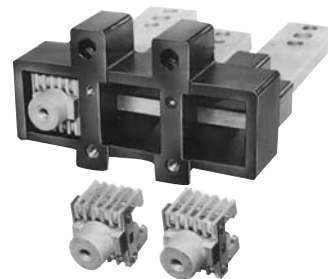

Plug-in Mounting Base
Product Number TK123PD2A shown

Plug-In Mounting Base Assembly

GO-135B

Ampere Rating	Breaker Type	Plug-In Mounting Bases - 2 Required Per Breaker				Product Number	List Price	Optional Mounting Base	
		No. Poles	Stud Configuration		Product Number			List Price	
			PD1	PD2					Product Number
150	E150 ¹	2	OLS	SLO	TE12PD1,2	\$250.00	TMP1	\$40.00	
	TB1	3	SLS	LSL	TE13PD1,2	\$375.00	TMP5	\$40.00	
	SE150	3	SLS	LSL	TE13PD1,2	\$375.00	TMP1	\$40.00	
225	F225	2	SOS	LOL	TF22PD1,2	\$300.00	TMP2	\$40.00	
		3	SLS	LSL	TF23PD1,2	\$450.00	TMP2	\$40.00	
250	SF250	2	SOS	LOL	TF22PD1,2	\$300.00	TMP2	\$40.00	
		3	SLS	LSL	TF23PD1,2	\$450.00	TMP2	\$40.00	
400	J400	2	SOS	LOL	TJ42PD1A,2A	\$400.00	TMP3	\$40.00	
		3	SLS	LSL	TJ43PD1A,2A	\$600.00	TMP3	\$40.00	
	TB4	2	SOS	LOL	TJ42PD1A,2A	\$400.00	TMP6	\$50.00	
		3	SLS	LSL	TJ43PD1A,2A	\$600.00	TMP6	\$50.00	
	SG400	3	SLS ²	LSL ²	SGPC1, SGPC2	\$600.00 ³	SMP3	\$40.00 ³	
600	J600, TJ4V, TJL	2	SOS	LOL	TJ62PD1A,2A	\$500.00	TMP3	\$40.00	
		3	SLS	LSL	TJ63PD1A,2A	\$750.00	TMP3	\$40.00	
	K1200, TKL, TK4V	2	SOS	LOL	TK62PD1A,2A	\$500.00	TMP4	\$50.00	
		3	SLS	LSL	TK63PD1A,2A	\$750.00	TMP4	\$50.00	
	TB6	2	SOS	LOL	TK62PD1A,2A	\$500.00	TMP7	\$50.00	
		3	SLS	LSL	TK63PD1A,2A	\$750.00	TMP7	\$50.00	
SG600	3	SLS ²	LSL ²	SGPC1, SGPC2	\$600.00 ³	SMP3	\$40.00 ³		
800	K1200, TK4V, TKL	2	SOS	LOL	TK82PD1A,2A	\$600.00	TMP4	\$50.00	
		3	SLS	LSL	TK83PD1A,2A	\$900.00	TMP4	\$50.00	
	TB8	2	SOS	LOL	TK82PD1A,2A	\$600.00	TMP7	\$50.00	
		3	SLS	LSL	TK83PD1A,2A	\$900.00	TMP7	\$50.00	
SK800	3	SLS	LSL	TK83PD1A,2A	\$900.00	TMP4	\$50.00		
1000	K1200, TK4V, TKL	2	SOS	LOL	TK102PD1A,2A	\$700.00	TMP4	\$50.00	
		3	SLS	LSL	TK103PD1A,2A	\$1050.00	TMP4	\$50.00	
1200	K1200, TK4V, TKL	2	SOS	LOL	TK103PD1A,2A	\$1050.00	TMP4	\$50.00	
		2	SOS	LOL	TK122PD1A,2A	\$800.00	TMP4	\$50.00	
		3	SLS	LSL	TK123PD1A,2A	\$1200.00	TMP4	\$50.00	
	SK1200	3	SLS	LSL	TK123PD1A,2A	\$1200.00	TMP4	\$50.00	

¹Order 3-pole base for use with 2-pole Hi Break and 600 Vac breakers.

²Vertical studs only for SG600 frame.

³GO-135S.



External Accessories

R-Frame

Ground Fault Neutral Sensors GO-245B

Current Sensor Rating	Neutral Sensor Product Number	List Price
1000A	TSVG810A	\$266.00
1600A	TSVG816A	\$266.00
2000A	TSVG820A	\$266.00

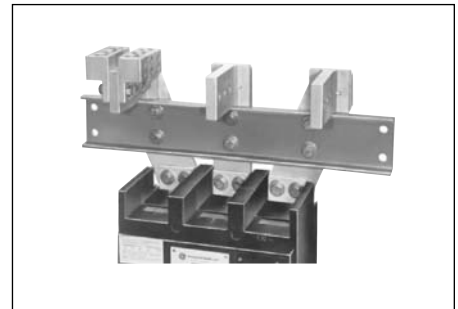

1600A Power Break with TPLUGA16 Adapter and 6 TPLUG108 Lugs

T-Studs GO-145A

Studs mount to breaker or adapter kit. Studs may be rotated for either vertical or horizontal bus. Product number includes 1 stud.

Maximum Breaker Ampacity	Product Number	List Price
1600A	TP16FCA	\$113.00
2000A	TP20FCA	\$113.00



Type TP16FCA T-Stud

Lug Kits GO-245B

Kits accept Cu/Al wire and are suitable for direct mounting to breaker. Order one kit per line or load pole. TPLUG108 is suitable for use only with the adapter kits described below.

Circuit Breaker Frame Size	Maximum Ampere Rating	Product Number	Lugs per Kit	Maximum Cables per Pole	Wire Range Cu/Al	List Price
1000-1600	1600	TPLUG408	1	4	500-800 kcmil	\$39.00
		TPLUG401	1	6	250-800 kcmil	\$23.00



Type TPLUG408 Lug Kit

Lug Adapter Kits GO-245B

Premounts to bus structure allowing cabling or bussing to be completed prior to breaker mounting. Accepts either lugs or crimp type connector terminals. Product number includes adapter and hardware for three-pole line side or three-pole load side connection. Kits include a set of three corresponding T-studs and are suitable for use with from 1 to 6 TPLUG108 lugs per pole or with from 1 to 6 Crimp Lugs (Anderson No. VCEL-075-12H1 or equivalent) per pole.

Maximum Breaker Ampacity	Product Number	List Price
1000/1600 A	TPLUGA16	\$389.00
2000 A	TPLUGA20	\$486.50

Kirk Key Provision (Factory Installation Only) GO-145A

Equips the breaker to accept a zero bolt projection Kirk Key device (supplied by customer) to permit sequencing of breaker operations with other key-type devices. The key remains captured in the breaker frame except when the breaker has been locked in the open position. Not compatible with door interlock and padlock device.

Number of Locks	Product Number	List Price
1	TPK01 (Type F)	\$817.00
2	TPK02 (Type M2F)	\$817.00
3	TPK03 (Type M3F)	\$817.00
4	TPK04 (Type M4F)	\$817.00

Terminal Block (Factory Installed Only) GO-145A

Offers an external means of terminating accessory leads at the breaker. A maximum of 18 terminals can be supplied on each side of the breaker (36 terminals total). For stationary breakers only. Terminal blocks are rated 10 amperes at 600 Vac.

Breaker	Terminals	Factory Installed Product Numbers Breaker Envelope Size (Amps) 1000, 1600 and 2000 ¹		List Price
		Product Number	List Price	
TRL/TRP R Frame	6	TPTB1R,L	\$158.00	
	12	TPTB2R,L	\$221.00	
	18	TPTB3R,L	\$286.00	
	24	TPTB4L	\$444.00	
	30	TPTB5L	\$508.00	
	36	TPTB6L	\$573.00	

¹Limited to left side only.

Walking Beam Interlock—Not UL listed GO-145A

Product Number	List Price
TPWB	\$525.00

Publications and Reference: See Section 21 for a list of additional product-related publications

Power Management System Accessories

Spectra RMS Circuit Breakers with MicroVersaTrip Plus and MicroVersaTrip PM Trip Units
All Devices UL Listed for Factory or Field Installation (UL File No. E-57253)

Required Accessories

	Type	Accessories
MicroVersaTrip Plus Trip Unit	Standard	-
	Ground Fault Option with 3-phase, 4-wire or 1-phase, 3-wire service	Neutral Current Sensor and Terminal Block or Neutral Current Sensor and Junction Box
	Control Power Option	Power Supply Plate or Voltage Module ¹ or Power Supply Assembly ²
MicroVersaTrip PM Trip Unit	Standard or with Protective Relaying	Power Supply Plate and Voltage Conditioner Plate or Voltage Module ¹ or Power Supply Assembly ² and Voltage Conditioner Assembly ²
	Ground Fault Option with 3-phase, 4-wire or 1-phase, 3-wire service	Junction Box, Cable Harness and Auxiliary Switch
		Neutral Current Sensor

¹For installation into GE Spectra Series Switchboards only.

²Requires fuse protection and other components; refer to accessory detail for additional information.

Power Supply Plate

GO-135PM

The Power Supply Plate is used to provide +24 Vdc control power to Spectra RMS Molded Case Circuit Breakers with MicroVersaTrip PM or MicroVersaTrip Plus trip systems via the Distribution Cable System. The Power Supply Plate includes the Power Supply Assembly (product number SPSAA) as an integral component and also includes fuse protection for AC source input. Supplemental +24 Vdc input terminals are provided for backup control power applications. Five versions are available. Not suitable for 400 Hz.

Description	Voltage Rating	Product Number	List Price
The Power Supply Plate is rated 24 watts (+24 Vdc at 1.0 amperes) and has the maximum capacity to power a distribution Cable System consisting of 20 breakers and has a maximum system cable length of 40 feet.	120 Vac	SPSA120	\$1215.00
	208 Vac	SPSA208	\$1215.00
	240 Vac	SPSA240	\$1215.00
	480 Vac	SPSA480	\$1215.00
	600 Vac	SPSA600	\$1215.00

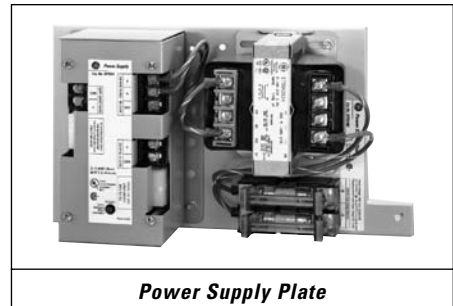

Power Supply Plate

Voltage Conditioner Plate

GO-135PM

The Voltage Conditioner Plate is used to provide voltage sensing signals to Spectra RMS Molded Case Circuit Breakers with MicroVersaTrip PM Trip Units via the Distribution Cable System. The Voltage Conditioner Plate includes the Voltage Conditioner Assembly (product number SVCAA) as an integral component and also includes fuse protection for the AC source input terminals and three 1-VA high accuracy potential transformers.

The Voltage Conditioner Plate requires a control power source of +24 Vdc to operate properly (the Power Supply Assembly or Power Supply Plate can provide this required input). The unit also requires AC direct voltage inputs from the AC source. A GE POWER LEADER network (commnet) connection is provided. Seven versions are available. Not suitable for 400 Hz.

Voltage Rating and Service Type	Comments	Product Number	List Price
120 Vac Wye system	Phase to Neutral potential	SVCA120Y	\$1000.00
208 Vac Wye system	Phase to Phase potential	SVCA208Y	\$1000.00
240 Vac Delta system	Phase to Phase potential	SVCA240D	\$1000.00
277 Vac Wye system	Phase to Neutral potential	SVCA277Y	\$1000.00
480 Vac Wye system	Phase to Phase potential	SVCA480Y	\$1000.00
480 Vac Delta system	Phase to Phase potential	SVCA480D	\$1000.00
600 Vac Delta system	Phase to Phase potential	SVCA600D	\$1000.00

Note: The Voltage Conditioner Plate has the maximum capacity to power a Distribution Cable System consisting of 20 breakers and has a maximum system cable length of 40 feet.

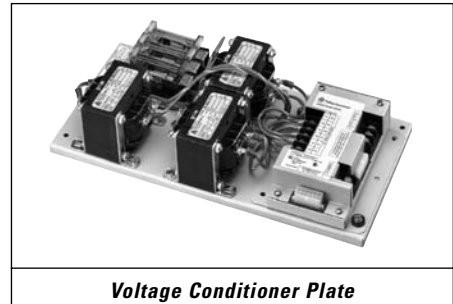

Voltage Conditioner Plate

Distribution Cable Junction Box

GO-135PM

The Distribution Cable Junction Box is a modular connector used to provide quick, easy and reliable attachment of Spectra RMS Molded Case Circuit Breakers with MicroVersaTrip Plus trip systems or MicroVersaTrip PM trip systems to the Distribution Cable System. The Junction Box contains two Distribution Cable Harness plugs, one breaker plug and a terminal block for the connection of a neutral current sensor and an auxiliary switch. Product number SDCJBA is for general purpose OEM applications. Product number SDCJBB is designed for mounting in Spectra Series Panelboards.

Description	Product Number	List Price
Distribution Cable Junction Box	SDCJBA	\$155.00
Distribution Cable Junction Box	SDCJBB	\$155.00

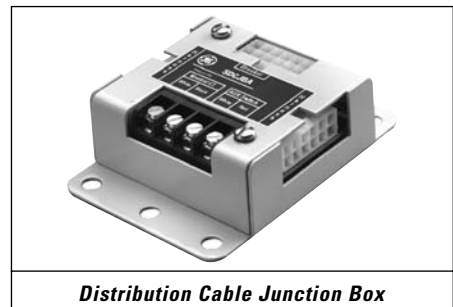

Distribution Cable Junction Box

Distribution Cable Harness³

GO-135PM

The Distribution Cable Harness is a modular connector used to carry electronic signals and/or control power between Spectra RMS Molded Case Circuit Breakers with MicroVersaTrip Plus or MicroVersaTrip PM Trip Units and Distribution Cable accessories. The harnesses come in three lengths.

Description	Harness Length	Product Number	List Price
Distribution Cable Harness	11 inches	SDCHA11	\$70.00
Distribution Cable Harness	30 inches	SDCHA30	\$80.00
Distribution Cable Harness	60 inches	SDCHA60	\$100.00

³Cannot be connected together. Use 30 inch Distribution Cable Extension (SDCEA30) to extend.

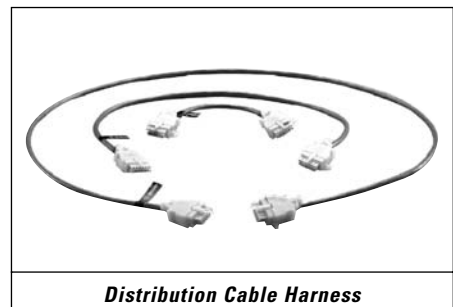

Distribution Cable Harness



Power Management System Accessories

Spectra RMS Circuit Breakers with MicroVersaTrip Plus and MicroVersaTrip PM Trip Units
All Devices UL Listed for Factory or Field Installation (UL File No. E-57253)

Required Accessories

	Type	Accessories
MicroVersaTrip Plus Trip Unit	Standard	—
	Ground Fault Option with 3-phase, 4-wire or 1-phase, 3-wire service	Neutral Current Sensor and Terminal Block or Neutral Current Sensor and Junction Box
	Control Power Option	Power Supply Plate or Voltage Module ¹ or Power Supply Assembly ²
MicroVersaTrip PM Trip Unit	Standard or with Protective Relaying	Power Supply Plate and Voltage Conditioner Plate or Voltage Module ¹ or Power Supply Assembly ² and Voltage Conditioner Assembly ²
	Ground Fault Option with 3-phase, 4-wire or 1-phase, 3-wire service	Junction Box, Cable Harness and Auxiliary Switch Neutral Current Sensor

¹For installation into GE Spectra Series Switchboards only.

²Requires fuse protection and other components; refer to accessory detail for additional information.

Distribution Cable Extension

GO-135PM

The Distribution Cable Extension is used to provide modular expansion of the Distribution Cable System.

Description	Harness Length	Product Number	List Price
Distribution Cable Extension	30 inches	SDCEA30	\$80.00

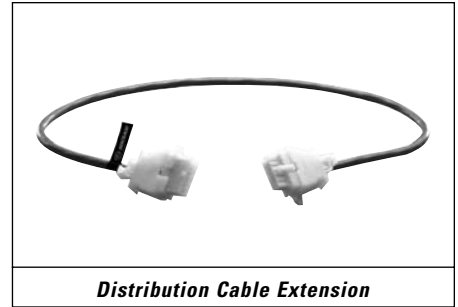

Distribution Cable Extension

Distribution Cable Terminal Block

GO-135PM

The Distribution Cable Terminal Block is a modular attachment primarily used to provide an alternate means of input to Spectra RMS Molded Case Circuit Breakers with MicroVersaTrip Plus or MicroVersaTrip PM Trip Units. The Terminal Block plugs into the breaker distribution cable receptacle allowing the direct connection of breaker signals via screw terminals. This allows point-to-point wiring of breakers instead of using the Distribution Cable System.

Description	Product Number	List Price
Distribution Cable Terminal Block	SDCTBA11	\$110.00

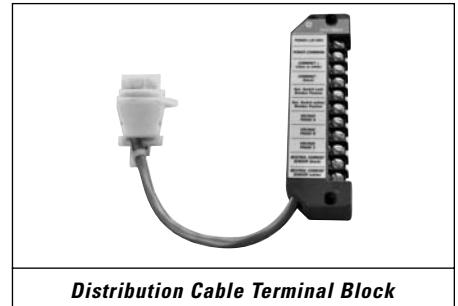

Distribution Cable Terminal Block

Power Supply Assembly

GO-135PM

The Power Supply Assembly is used to provide +24 Vdc Control Power to Spectra RMS Molded Case Circuit Breakers with MicroVersaTrip Plus or MicroVersaTrip PM trip systems via the Distribution Cable System. The assembly requires a minimum input voltage of 85 Vac to operate properly (the maximum voltage rating is 240 Vac). Supplemental +24 Vdc input terminals are provided for backup control power applications. The input must be fused with 1/2 ampere class CC fuses (not included). Not suitable for 400 Hz.

Description	Voltage Rating	Product Number	List Price
The Power Supply Assembly is rated 24 watts (+24 Vdc @ 1.0 ampere) and has the maximum capacity to power a Distribution Cable System consisting of 20 breakers and has a maximum system cable length of 40 feet.	85 - 240 Vac	SPSAA	\$1000.00

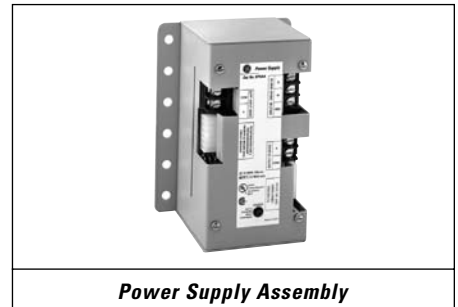

Power Supply Assembly

Voltage Conditioner Assembly

GO-135PM

The Voltage Conditioner Assembly is used to provide voltage sensing signals to Spectra RMS Molded Case Circuit Breakers with MicroVersaTrip PM Trip Units via the Distribution Cable System. The Voltage Conditioner Assembly requires a control power source of +24 Vdc to operate properly (the Power Supply Assembly or Power Supply Plate can provide this required input). The unit also requires 120 Vac voltage inputs from the secondary of three 1-VA high accuracy potential transformers (not included). The primary side of the potential transformers must be fused with three, 1/2 ampere class CC fuses (not included). A GE POWER LEADER network (commnet) connection is provided. Not suitable for 400 Hz.

Description	Voltage Rating	Product Number	List Price
Requires 120 Vac voltage inputs from the secondary of three 1.0 VA high accuracy potential transformers	120 Vac	SVCAA	\$680.00

Note: the Voltage Conditioner Assembly has the maximum capacity to power a Distribution Cable System consisting of 20 breakers and has a maximum system cable length of 40 feet.

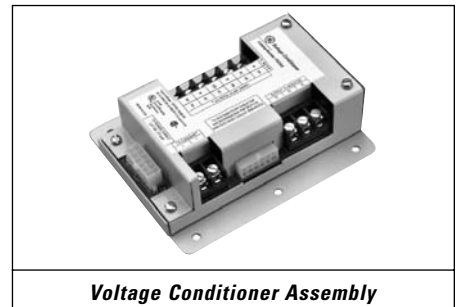

Voltage Conditioner Assembly

Publications and Reference: See Section 21 for a list of additional product-related publications

Power Management System Accessories

Spectra RMS Circuit Breakers with MicroVersaTrip Plus and MicroVersaTrip PM Trip Units

All Devices UL Listed for Factory or Field Installation (UL File No. E-57253)

Voltage Modules

GO-135PM

The Voltage Module is used primarily as a Spectra Series Switchboard component to provide +24 Vdc Control Power to Spectra RMS Molded Case Circuit Breakers with MicroVersaTrip Plus or MicroVersaTrip PM Trip Units via the Distribution Cable System. The Module also provides voltage sensing signals to Spectra RMS Molded Case Circuit Breakers with MicroVersaTrip PM Trip Units on the same Distribution Cable System. The Module contains both a Power Supply Plate and a Voltage Conditioner as integral components. It also includes fuse protection for the AC source input terminals (the modules pressure connectors which mate with the switchboard interior bus bars). A GE POWER LEADER Network (commnet) connection is provided as well as supplemental 24 Vdc input terminals for backup control power applications. Seven versions are available. Not suitable for 400 Hz.

Voltage Rating and Service Type	Comments	Product Number	List Price
120 Vac Wye system	Phase to Neutral potential	ADSVMA120Y	\$2350.00
208 Vac Wye system	Phase to Phase potential	ADSVMA208Y	\$2350.00
240 Vac Delta system	Phase to Phase potential	ADSVMA240D	\$2350.00
277 Vac Wye system	Phase to Neutral potential	ADSVMA277Y	\$2350.00
480 Vac Wye system	Phase to Phase potential	ADSVMA480Y	\$2350.00
480 Vac Delta system	Phase to Phase potential	ADSVMA480D	\$2350.00
600 Vac Delta system	Phase to Phase potential	ADSVMA600D	\$2350.00

Note: The Voltage Module has the maximum capacity to power a Distribution Cable System consisting of 20 breakers and has a maximum system cable length of 40 feet.

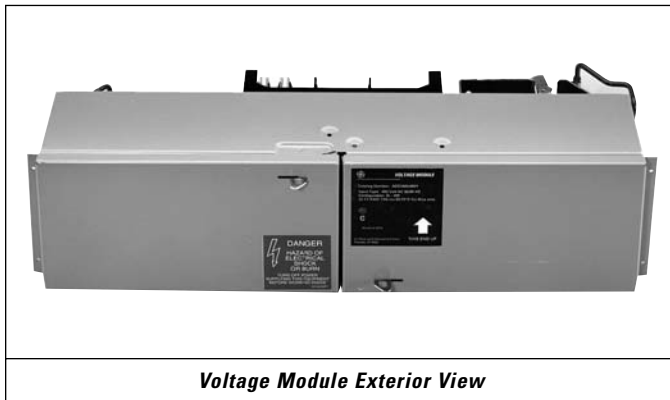

Voltage Module Exterior View

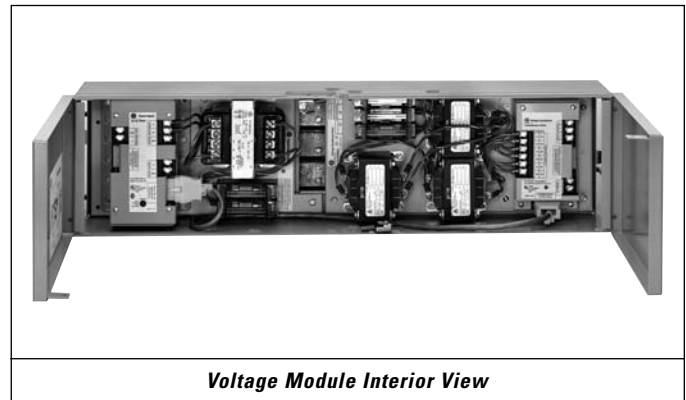

Voltage Module Interior View



Accessories—Other

Spectra RMS Circuit Breakers with MicroVersaTrip Plus and MicroVersaTrip PM Trip Units
All Devices UL Listed for Factory or Field Installation Except Where Noted

Neutral Current Sensor

GO-135S

The neutral current sensor is used in conjunction with breakers that have a MicroVersaTrip Plus or MicroVersaTrip PM Trip Unit with the optional ground fault function and the breaker is connected to a grounded neutral service (3-phase, 4-wire or 1-phase, 3-wire). The neutral current sensor provides an input signal to the breaker trip unit. Breakers connected to a service without a neutral (3-phase, 3-wire) require no external connection or shorting of the breaker cable connector for ground fault to function properly.

Breaker Type	Sensor Rating (S)	Product Number	List Price
SG	150	TSRG201	\$532.00
SG	400	TSRG204	\$532.00
SG	600	TSRG206	\$532.00
SK	800	TSKG408	\$532.00
SK	1200	TSKG412	\$532.00

MicroVersaTrip Rating Plug Removal Tool

GO-135S

Product Number	List Price
TRTOOL	\$12.00

MicroVersaTrip Portable Power Pack

GO-245A

The hand-held MicroVersaTrip portable battery pack provides an independent power source for MicroVersaTrip Plus and MicroVersaTrip PM trip units as an alternative to the TVRMS test set. The power pack is used to power up the trip unit to set or adjust trip set points when the breaker is on the bench or otherwise not powered up. It connects to the trip unit through the rating plug test jack. It requires three standard 9 Vdc alkaline batteries (not included).

Description	Product Number	List Price
Portable Power Pack	TVPBP	\$75.00

MicroVersaTrip Portable Test Set

GO-245A

The portable, battery-powered test kit provides for RMS-9, Plus, or PM trip unit self-tests and functional trip/no trip tests. It also provides defeat of the ground fault function and can be used in conjunction with high current test equipment. Interface is via a plug on the front of the trip unit and tests can be conducted with breaker in service. Kit uses six rechargeable ni-cad or standard alkaline "D" cells supplied by customer. Kit can also be powered by 120 Vac source.

Description	Product Number	List Price
Portable Test Set ²	TVRMS2	\$3000.00

²May also be used to temporarily defeat ground fault function when using primary injection (high current test set).
 Note: This test kit is for use with MicroVersaTrip RMS-9, Plus, or PM Trip Units only. Not for use with MicroVersaTrip 4- or 9-Function Trip Units.



