

RAD-TOLERANT CLASS V, WIDEBAND, FULLY DIFFERENTIAL AMPLIFIER

FEATURES

- Fully Differential Architecture
- Centered Input Common-Mode Range
- Minimum Gain of 2V/V (6 dB)
- Bandwidth: 1100 MHz (Gain = 6 dB)
- Slew Rate: 5100 V/ μ s
- 1% Settling Time: 5.5 ns
- HD₂: -76 dBc at 70 MHz
- HD₃: -88 dBc at 70 MHz
- OIP₂: 84 dBm at 70 MHz
- OIP₃: 42 dBm at 70 MHz
- Input Voltage Noise: 2.2 nV/ $\sqrt{\text{Hz}}$ (f >10 MHz)
- Noise Figure: 19.8 dB
- Output Common-Mode Control
- Power Supply:
 - Voltage: 3 V (± 1.5 V) to 5 V (± 2.5 V)
 - Current: 37.7 mA
- Power-Down Capability: 0.65 mA
- Rad-Tolerant: 150 kRad (Si) TID
- QML-V Qualified, SMD 5962-07223

APPLICATIONS

- 5 V Data-Acquisition Systems
- High-Linearity ADC Amplifier
- Wireless Communication
- Medical Imaging
- Test and Measurement

RELATED PRODUCTS

DEVICE	MIN. GAIN	COMMON-MODE RANGE OF INPUT ⁽¹⁾
THS4511-SP	6 dB	-0.3 V to 2.3 V
THS4513-SP	6 dB	0.75 V to 4.25 V

(1) Assumes a 5 V single-ended power supply.

DESCRIPTION/ORDERING INFORMATION

The THS4513 is a wideband, fully differential op amp designed for 3.3 V to 5 V data-acquisition systems. It has very low noise at 2.2 nV/ $\sqrt{\text{Hz}}$, and extremely low harmonic distortion of -76 dBc HD₂ and -88 dBc HD₃ at 70 MHz with 2 V_{pp} output, G = 14 dB, and 100 Ω load. Slew rate is very high at 5100 V/ μ s and with settling time of 5.5 ns to 1% (2 V step), it is ideal for pulsed applications. It is suitable for minimum gain of 6 dB.

To allow for dc coupling to ADCs, its unique output common-mode control circuit maintains the output common-mode voltage within 5 mV offset (typ) from the set voltage, when set within 0.5 V of mid-supply, with less than 4 mV differential offset voltage. The common-mode set point is set to mid-supply by internal circuitry, which may be over-driven from an external source.

The input and output are optimized for best performance with their common-mode voltages set to mid-supply. Along with high performance at low power supply voltage, this makes for extremely high performance single supply 5 V data acquisition systems.

The THS4513 is offered in a 16-pin ceramic flatpack package (W), and is characterized for operation over the full military temperature range from -55°C to 125°C.

THS4513 + ADS5424 Circuit

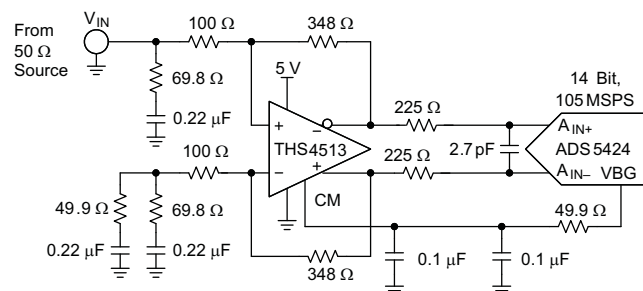

Please be aware that an important notice concerning availability, standard warranty, and use in critical applications of Texas Instruments semiconductor products and disclaimers thereto appears at the end of this data sheet.



This integrated circuit can be damaged by ESD. Texas Instruments recommends that all integrated circuits be handled with appropriate precautions. Failure to observe proper handling and installation procedures can cause damage.

ESD damage can range from subtle performance degradation to complete device failure. Precision integrated circuits may be more susceptible to damage because very small parametric changes could cause the device not to meet its published specifications.

PACKAGING/ORDERING INFORMATION⁽¹⁾

TEMPERATURE	PACKAGED DEVICES	
	CERAMIC FLATPACK W (16) ⁽²⁾	SYMBOL
-55°C to 125°C	5962-0722301VFA	5962-0722301VFA

- (1) For the most current package and ordering information, see the Package Option Addendum at the end of this document, or see the TI website at www.ti.com.
- (2) Package drawings, thermal data, and symbolization are available at www.ti.com/packaging.

ABSOLUTE MAXIMUM RATINGS⁽¹⁾

over operating free-air temperature range (unless otherwise noted)

		UNIT
V_{S-} to V_{S+}	Supply voltage	6 V
V_I	Input voltage	$\pm V_S$
V_{ID}	Differential input voltage	4 V
I_O	Output current	200 mA
Continuous power dissipation		See Dissipation Rating Table
T_J	Maximum junction temperature	150°C
T_A	Operating free-air temperature range	-55°C to 125°C
T_{stg}	Storage temperature range	-65°C to 150°C
ESD ratings	HBM	2000
	CDM	1500
	MM	100

- (1) The absolute maximum ratings under any condition are limited by the constraints of the silicon process. Stresses above these ratings may cause permanent damage. Exposure to absolute maximum conditions for extended periods may degrade device reliability. These are stress ratings only, and functional operation of the device at these or any other conditions beyond those specified is not implied.

DISSIPATION RATING TABLE

PACKAGE	θ_{JC}	θ_{JA}	POWER RATING	
			$T_A \leq 25^\circ\text{C}$	$T_A = 125^\circ\text{C}$
W (16)	14.7°C/W	189°C/W	661 mW	132 mW

SPECIFICATIONS; $V_{S+} - V_{S-} = 5\text{ V}$ (Unchanged after 150 kRad):

 Test conditions unless otherwise noted: $V_{S+} = 2.5\text{ V}$, $V_{S-} = -2.5\text{ V}$, $G = 14\text{ dB}$, $CM = \text{open}$, $V_O = 2\text{ Vpp}$, $R_F = 348\ \Omega$, $R_L = 200\ \Omega$ Differential, $T_A = 25^\circ\text{C}$ Single-Ended Input, Differential Output, Input and Output Referenced to Mid-Supply

PARAMETER	TEST CONDITIONS	MIN	TYP	MAX	UNIT
AC PERFORMANCE					
Small-Signal Bandwidth	$G = 6\text{ dB}$, $V_O = 100\text{ mVpp}$		1.1		GHz
	$G = 10\text{ dB}$, $V_O = 100\text{ mVpp}$		1.0		GHz
	$G = 14\text{ dB}$, $V_O = 100\text{ mVpp}$		720		MHz
Gain-Bandwidth Product	$G = 10\text{ dB}$		3.0		GHz
Bandwidth for 0.1 dB Flatness	$G = 10\text{ dB}$, $V_O = 2\text{ Vpp}$		65		MHz
	$G = 14\text{ dB}$, $V_O = 2\text{ Vpp}$		115		
Large-Signal Bandwidth	$G = 6\text{ dB}$, $V_O = 2\text{ Vpp}$		1.1		GHz
Slew Rate (Differential)			5100		V/ μs
Rise Time Fall Time	2 V Step, $G = 6\text{ dB}$		0.5		ns
Settling Time to 1%			0.5		
2 nd Order Harmonic Distortion	$f = 10\text{ MHz}$, $R_L = 100\ \Omega$		-106		dBc
	$f = 50\text{ MHz}$, $R_L = 100\ \Omega$		-90		
	$f = 100\text{ MHz}$, $R_L = 100\ \Omega$		-87		
3 rd Order Harmonic Distortion	$f = 10\text{ MHz}$, $R_L = 100\ \Omega$		-108		dBc
	$f = 50\text{ MHz}$, $R_L = 100\ \Omega$		-106		
	$f = 100\text{ MHz}$, $R_L = 100\ \Omega$		-83		
2 nd Order Intermodulation Distortion	$V_O = 2\text{ Vpp}$ envelope, 200 kHz Tone Spacing, $R_L = 100\ \Omega$	$f_C = 50\text{ MHz}$	-83		dBc
3 rd Order Intermodulation Distortion		$f_C = 100\text{ MHz}$	-75		
2 nd Order Output Intercept Point	200 kHz Tone Spacing $R_L = 100\ \Omega$	$f_C = 50\text{ MHz}$	84		dBm
		$f_C = 100\text{ MHz}$	77		
3 rd Order Output Intercept Point	$f_C = 50\text{ MHz}$	42			
	$f_C = 100\text{ MHz}$	38			
Noise Figure	50 Ω System, 10 MHz, $G = 6\text{ dB}$		19.8		dB
Input Voltage Noise	$f > 10\text{ MHz}$		2.2		nV/ $\sqrt{\text{Hz}}$
Input Current Noise	$f > 10\text{ MHz}$		1.7		pA/ $\sqrt{\text{Hz}}$
DC PERFORMANCE					
Open-Loop Voltage Gain (A_{OL})			63		dB
Input Offset Voltage	$T_A = 25^\circ\text{C}$		1	4	mV
	$T_A = -55^\circ\text{C}$ to 125°C			5.5	mV
Average Offset Voltage Drift	$T_A = -55^\circ\text{C}$ to 125°C		2.6		$\mu\text{V}/^\circ\text{C}$
Input Bias Current	$T_A = 25^\circ\text{C}$		8	15.5	μA
	$T_A = -55^\circ\text{C}$ to 125°C			20	
Average Bias Current Drift	$T_A = -55^\circ\text{C}$ to 125°C		20		nA/ $^\circ\text{C}$
Input Offset Current	$T_A = 25^\circ\text{C}$		1.6	3.6	μA
	$T_A = -55^\circ\text{C}$ to 125°C			7	
Average Offset Current Drift	$T_A = -55^\circ\text{C}$ to 125°C		4		nA/ $^\circ\text{C}$

SPECIFICATIONS; $V_{S+} - V_{S-} = 5\text{ V}$ (Unchanged after 150 kRad): (continued)

Test conditions unless otherwise noted: $V_{S+} = 2.5\text{ V}$, $V_{S-} = -2.5\text{ V}$, $G = 14\text{ dB}$, $CM = \text{open}$, $V_O = 2\text{ Vpp}$, $R_F = 348\ \Omega$, $R_L = 200\ \Omega$ Differential, $T_A = 25^\circ\text{C}$ Single-Ended Input, Differential Output, Input and Output Referenced to Mid-Supply

PARAMETER	TEST CONDITIONS	MIN	TYP	MAX	UNIT
INPUT					
Common-Mode Input Range High			1.75		V
Common-Mode Input Range Low			-1.75		
Common-Mode Rejection Ratio			80		dB
Differential Input Impedance			1.67 0.5		M Ω pF
Common-Mode Input Impedance			1.2 1.5		
OUTPUT					
Maximum Output Voltage High	Each output with 100 Ω to mid-supply	$T_A = 25^\circ\text{C}$	1.2	1.4	V
		$T_A = -55^\circ\text{C}$ to 125°C	1.0		
Minimum Output Voltage Low		$T_A = 25^\circ\text{C}$		-1.4	V
		$T_A = -55^\circ\text{C}$ to 125°C		-1.0	
Differential Output Voltage Swing	$T_A = 25^\circ\text{C}$	4.8	5.6		V
	$T_A = -55^\circ\text{C}$ to 125°C	4.0			
Differential Output Current Drive	$R_L = 10\ \Omega$		96		mA
Output Balance Error	$V_O = 100\text{ mV}$, $f = 1\text{ MHz}$		-52		dB
Closed-Loop Output Impedance	$f = 1\text{ MHz}$		0.3		Ω
OUTPUT COMMON-MODE VOLTAGE CONTROL					
Small-Signal Bandwidth			250		MHz
Slew Rate			110		V/ μs
Gain			1		V/V
Output Common-Mode Offset from CM input	$-1\text{ V} < CM < 1\text{ V}$		5		mV
CM Input Bias Current	$-1\text{ V} < CM < 1\text{ V}$		± 40		μA
CM Input Voltage Range			-1.25 to 1.25		V
CM Input Impedance			23 2.8		k Ω pF
CM Default Voltage			0		V
POWER SUPPLY					
Specified Operating Voltage		3	5	5.5	V
Maximum Quiescent Current	$T_A = 25^\circ\text{C}$		37.7	40.9	mA
	$T_A = -55^\circ\text{C}$ to 125°C			42.5	
Minimum Quiescent Current	$T_A = 25^\circ\text{C}$	34.5	37.7		mA
	$T_A = -55^\circ\text{C}$ to 125°C	32.5			
Power Supply Rejection ($\pm\text{PSRR}$)			90		dB
POWER DOWN					
Enable Voltage Threshold	Referenced to V_{S-} , Assured on above $2.1\text{ V} + V_{S-}$		$>2.1 + V_{S-}$		V
Disable Voltage Threshold	Assured off below $0.7\text{ V} + V_{S-}$		$<0.7 + V_{S-}$		V
Powerdown Quiescent Current	$T_A = 25^\circ\text{C}$		0.65	0.9	mA
	$T_A = -55^\circ\text{C}$ to 125°C			1.2	
Input Bias Current	$\overline{PD} = V_{S-}$		100		μA
Input Impedance			50 2		k Ω pF
Turn-on Time Delay	Measured to output on		55		ns
Turn-off Time Delay	Measured to output off		10		μs

SPECIFICATIONS; $V_{S+} - V_{S-} = 3\text{ V}$ (Unchanged after 150 kRad):

Test conditions unless otherwise noted: $V_{S+} = 1.5\text{ V}$, $V_{S-} = -1.5\text{ V}$, $G = 14\text{ dB}$, $CM = \text{open}$, $V_O = 1\text{ Vpp}$, $R_F = 348\ \Omega$, $R_L = 200\ \Omega$ Differential, $T_A = 25^\circ\text{C}$ Single-Ended Input, Differential Output, Input and Output Referenced to Mid-Supply

PARAMETER	TEST CONDITIONS	TYP	UNIT	
AC PERFORMANCE				
Small-Signal Bandwidth	$G = 6\text{ dB}$, $V_O = 100\text{ mVpp}$	1.1	GHz	
	$G = 10\text{ dB}$, $V_O = 100\text{ mVpp}$	1.0	GHz	
Gain-Bandwidth Product	$G = 10\text{ dB}$	3.0	GHz	
Bandwidth for 0.1 dB Flatness	$G = 10\text{ dB}$, $V_O = 1\text{ Vpp}$	68	MHz	
	$G = 14\text{ dB}$, $V_O = 1\text{ Vpp}$	115		
Large-Signal Bandwidth	$G = 6\text{ dB}$, $V_O = 1\text{ Vpp}$	1.1	GHz	
Slew Rate (Differential)	1V Step, $G = 6\text{ dB}$	2600	V/ μs	
Rise Time		0.25	ns	
Fall Time		0.25		
Settling Time to 1%		5.5		
2 nd Order Harmonic Distortion		$f = 10\text{ MHz}$, $R_L = 100\ \Omega$	-100	dBc
	$f = 50\text{ MHz}$, $R_L = 100\ \Omega$	-70		
	$f = 100\text{ MHz}$, $R_L = 100\ \Omega$	-63		
3 rd Order Harmonic Distortion	$f = 10\text{ MHz}$, $R_L = 100\ \Omega$	-75	dBc	
	$f = 50\text{ MHz}$, $R_L = 100\ \Omega$	-64		
	$f = 100\text{ MHz}$, $R_L = 100\ \Omega$	-45		
2 nd Order Intermodulation Distortion	$V_O = 1\text{ Vpp}$ 200 kHz Tone Spacing, $R_L = 100\ \Omega$	$f_C = 50\text{ MHz}$	-93	dBc
3 rd Order Intermodulation Distortion		$f_C = 100\text{ MHz}$	-80	
		$f_C = 50\text{ MHz}$	-80	
		$f_C = 100\text{ MHz}$	-74	
2 nd Order Output Intercept Point	200 kHz Tone Spacing $R_L = 100\ \Omega$	$f_C = 50\text{ MHz}$	58	dBm
3 rd Order Output Intercept Point		$f_C = 100\text{ MHz}$	52	
		$f_C = 50\text{ MHz}$	32	
		$f_C = 100\text{ MHz}$	26	
Noise Figure	50 Ω System, 10 MHz, $G = 6\text{ dB}$	19.8	dB	
Input Voltage Noise	$f > 10\text{ MHz}$	2.2	nV/ $\sqrt{\text{Hz}}$	
Input Current Noise	$f > 10\text{ MHz}$	1.7	pA/ $\sqrt{\text{Hz}}$	
DC PERFORMANCE				
Open-Loop Voltage Gain (A_{OL})		68	dB	
Input Offset Voltage	$T_A = 25^\circ\text{C}$	1	mV	
Average Offset Voltage Drift	$T_A = -55^\circ\text{C}$ to 125°C	2.6	$\mu\text{V}/^\circ\text{C}$	
Input Bias Current	$T_A = 25^\circ\text{C}$	6	μA	
Average Bias Current Drift	$T_A = -55^\circ\text{C}$ to 125°C	20	nA/ $^\circ\text{C}$	
Input Offset Current	$T_A = 25^\circ\text{C}$	1.6	μA	
Average Offset Current Drift	$T_A = -55^\circ\text{C}$ to 125°C	4	nA/ $^\circ\text{C}$	
INPUT				
Common-Mode Input Range High		0.75	V	
Common-Mode Input Range Low		-0.75		
Common-Mode Rejection Ratio		80	dB	
Differential Input Impedance		1.67 0.5	M Ω pF	
Common-Mode Input Impedance		1.2 1.5		

SPECIFICATIONS; $V_{S+} - V_{S-} = 3\text{ V}$ (Unchanged after 150 kRad): (continued)

Test conditions unless otherwise noted: $V_{S+} = 1.5\text{ V}$, $V_{S-} = -1.5\text{ V}$, $G = 14\text{ dB}$, $CM = \text{open}$, $V_O = 1\text{ V}_{pp}$, $R_F = 348\ \Omega$, $R_L = 200\ \Omega$ Differential, $T_A = 25^\circ\text{C}$ Single-Ended Input, Differential Output, Input and Output Referenced to Mid-Supply

PARAMETER	TEST CONDITIONS	TYP	UNIT
OUTPUT			
Maximum Output Voltage High	Each output with 100 Ω to mid-supply	0.45	V
Minimum Output Voltage Low		-0.45	V
Differential Output Voltage Swing		1.8	V
Differential Output Current Drive	$R_L = 10\ \Omega$	50	mA
Output Balance Error	$V_O = 100\text{ mV}$, $f = 1\text{ MHz}$	-54	dB
Closed-Loop Output Impedance	$f = 1\text{ MHz}$	0.3	Ω
OUTPUT COMMON-MODE VOLTAGE CONTROL			
Small-Signal Bandwidth		150	MHz
Slew Rate		60	V/ μs
Gain		1	V/V
Output Common-Mode Offset from CM input	$-0.5\text{ V} < CM < 0.5\text{ V}$	4	mV
CM Input Bias Current	$-0.5\text{ V} < CM < 0.5\text{ V}$	± 40	μA
CM Input Voltage Range		-1.5 to 1.5	V
CM Input Impedance		20 2.8	k Ω pF
CM Default Voltage		0	V
POWER SUPPLY			
Quiescent Current		34.8	mA
Power Supply Rejection ($\pm\text{PSRR}$)		80	dB
POWER DOWN			
Enable Voltage Threshold	Referenced to V_{S-} , Assured on above $2.1\text{ V} + V_{S-}$	>2.1	V
Disable Voltage Threshold	Assured off below $0.7\text{ V} + V_{S-}$	<0.7	V
Powerdown Quiescent Current		0.46	mA
Input Bias Current	$\text{PD} = V_{S-}$	65	μA
Input Impedance		50 2	k Ω pF
Turn-On Time Delay	Measured to output on	100	ns
Turn-Off Time Delay	Measured to output off	10	μs

**W PACKAGE
TOP VIEW**

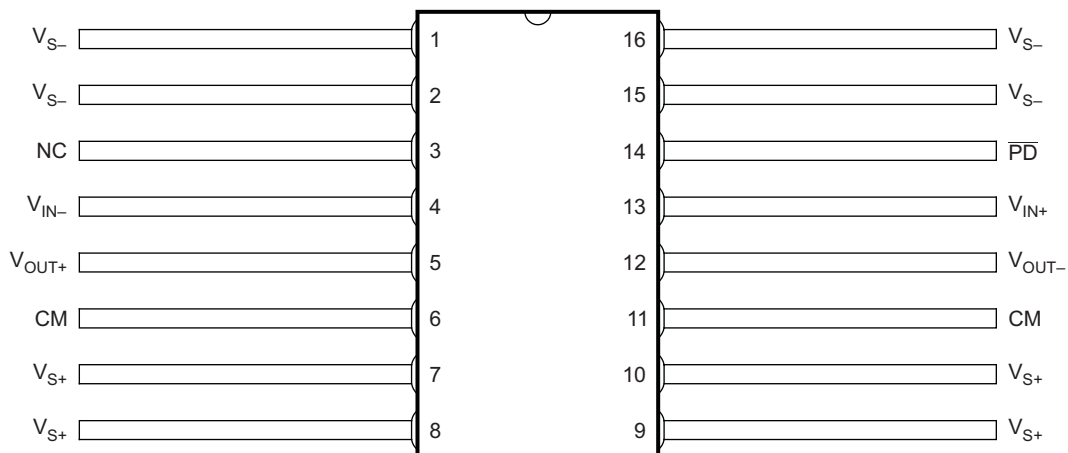

TERMINAL FUNCTIONS

TERMINAL (RGT PACKAGE)		DESCRIPTION
NO.	NAME	
3	NC	No internal connection
4	V_{IN-}	Inverting amplifier input
5	V_{OUT+}	Non-inverting amplifier output
6, 11	CM	Common-mode voltage input
7, 8, 9, 10	V_{S+}	Positive amplifier power supply input
12	V_{OUT-}	Inverting amplifier output
13	V_{IN+}	Non-inverting amplifier input
14	\overline{PD}	Powerdown, \overline{PD} = logic low puts part into low power mode, \overline{PD} = logic high or open for normal operation
1, 2, 15, 16	V_{S-}	Negative amplifier power supply input

TYPICAL CHARACTERISTICS

TYPICAL AC PERFORMANCE: $V_{S+} - V_{S-} = 5\text{ V}$

Test conditions unless otherwise noted: $V_{S+} = +2.5\text{ V}$, $V_{S-} = -2.5\text{ V}$, CM = open, $V_{OD} = 2\text{ V}_{PP}$, $R_F = 348\ \Omega$, $R_L = 200\ \Omega$
Differential, G = 14 dB, Single-Ended Input, Input and Output Referenced to Mid-Supply

Small-Signal Frequency Response	G = 6 dB, $V_{OD} = 100\text{ mV}_{PP}$		Figure 1
	G = 10 dB, $V_{OD} = 100\text{ mV}_{PP}$		Figure 2
	G = 14 dB, $V_{OD} = 100\text{ mV}_{PP}$		Figure 3
Large-Signal Frequency Response	G = 6 dB, $V_{OD} = 2\text{ V}_{PP}$		Figure 4
	G = 10 dB, $V_{OD} = 2\text{ V}_{PP}$		Figure 5
	G = 14 dB, $V_{OD} = 2\text{ V}_{PP}$		Figure 6
Harmonic Distortion	HD ₂ , G = 14 dB, $V_{OD} = 2\text{ V}_{PP}$	vs Frequency	Figure 7
	HD ₃ , G = 14 dB, $V_{OD} = 2\text{ V}_{PP}$	vs Frequency	Figure 8
	HD ₂ , G = 14 dB	vs Output Voltage	Figure 9
	HD ₃ , G = 14 dB	vs Output Voltage	Figure 10
Intermodulation Distortion	IMD ₂ , G = 14dB	vs Frequency	Figure 11
	IMD ₃ , G = 14dB	vs Frequency	Figure 12
Output Intercept Point	OIP ₂	vs Frequency	Figure 13
	OIP ₃	vs Frequency	Figure 14
Transition Rate		vs Output Voltage	Figure 15
Transient Response			Figure 16
Rejection Ratio		vs Frequency	Figure 17
Overdrive Recovery			Figure 18
Output Voltage Swing		vs Load Resistance	Figure 19
Turn-Off Time			Figure 20
Turn-On Time			Figure 21
Input Offset Voltage		vs Input Common-Mode Voltage	Figure 22
Input Referred Noise		vs Frequency	Figure 23
Noise Figure		vs Frequency	Figure 24
Quiescent Current		vs Supply Voltage	Figure 25
Power Down Quiescent Current		vs Supply Voltage	Figure 26
Output Balance Error		vs Frequency	Figure 27
CM Input Bias Current		vs CM Input Voltage	Figure 28
Differential Output Offset Voltage		vs CM Input Voltage	Figure 29
Common-Mode Output Offset Voltage		vs CM Input Voltage	Figure 30

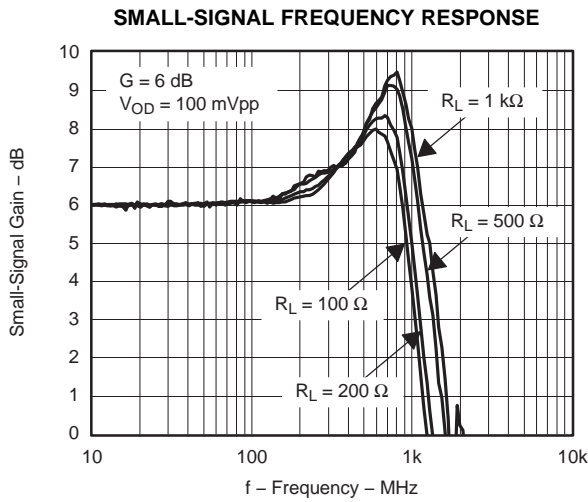

Figure 1.

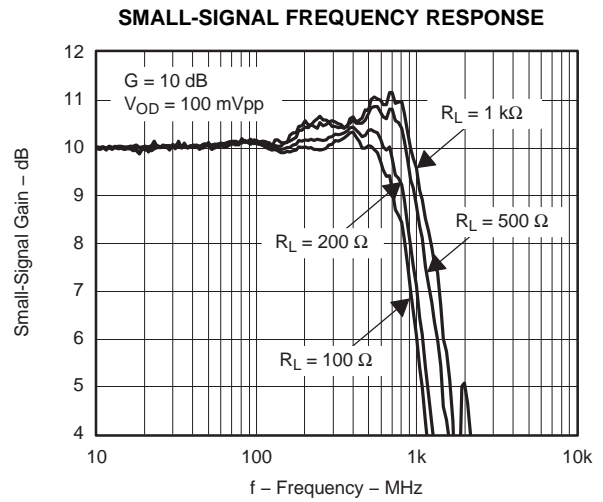

Figure 2.

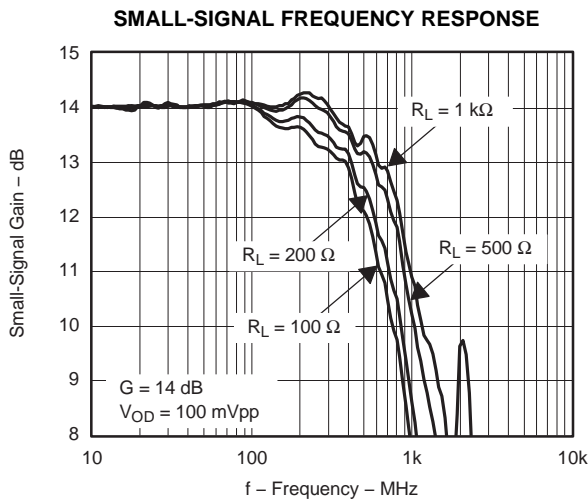

Figure 3.

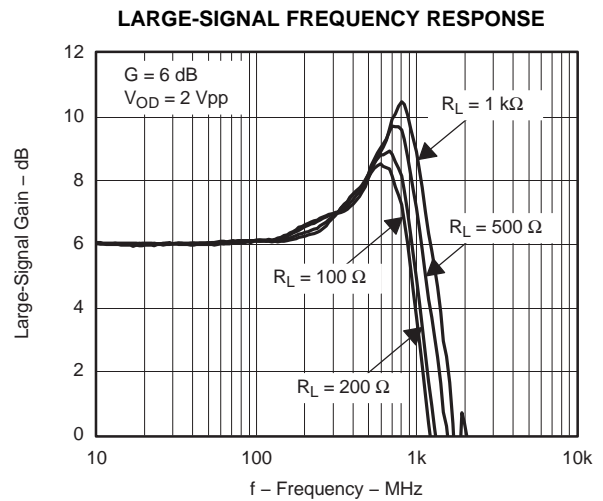

Figure 4.

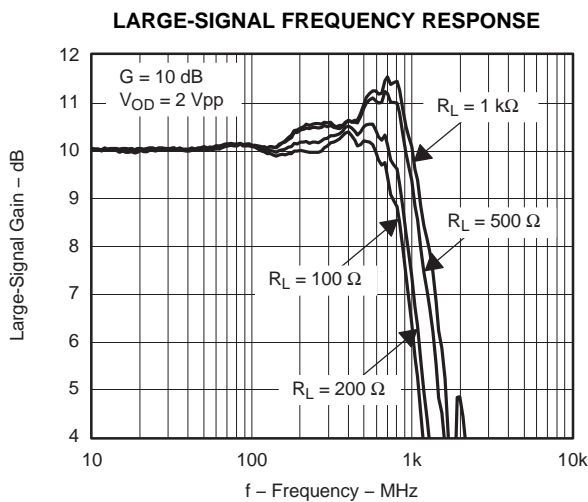

Figure 5.

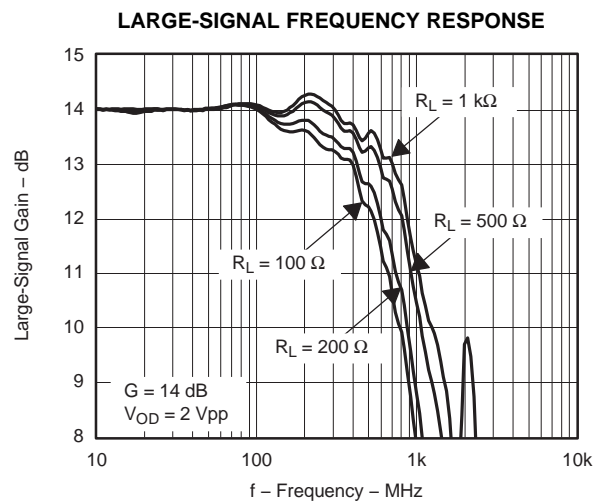

Figure 6.

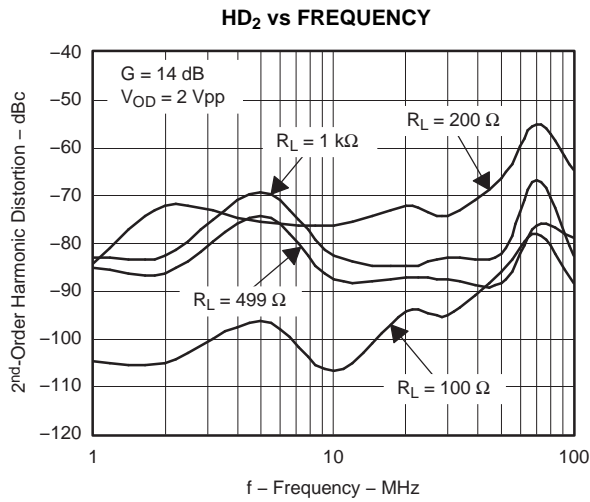

Figure 7.

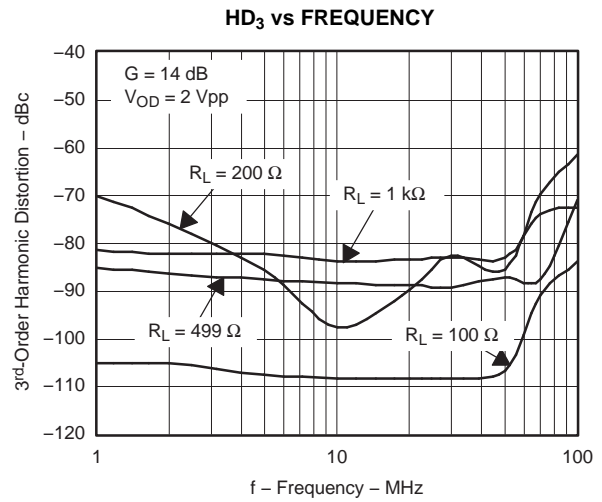

Figure 8.

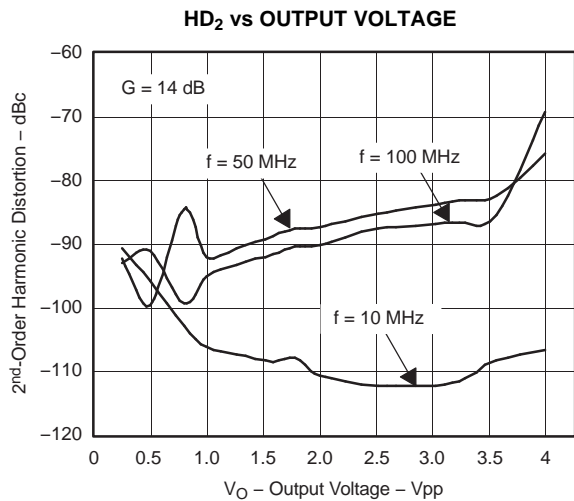

Figure 9.

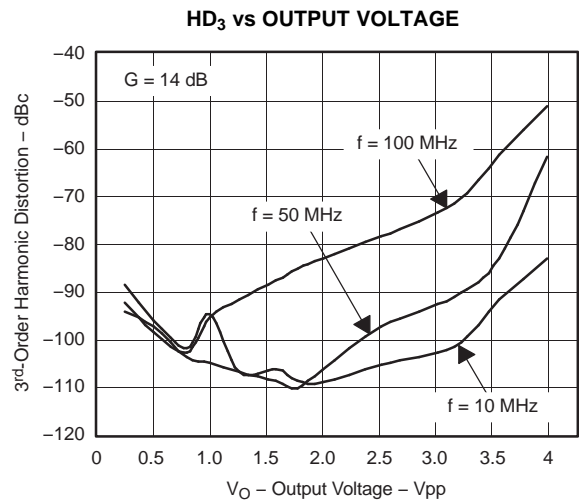

Figure 10.

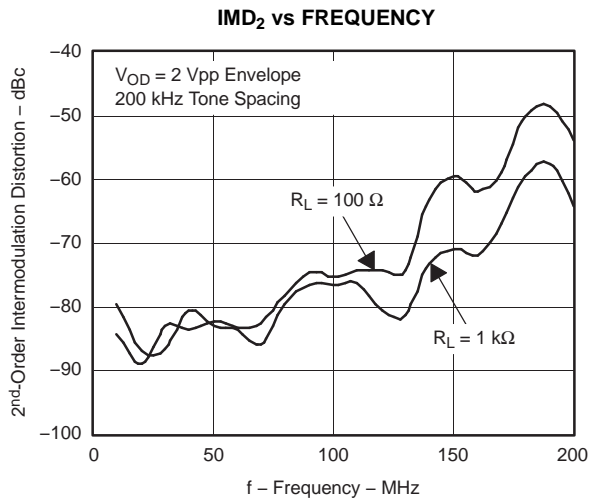

Figure 11.

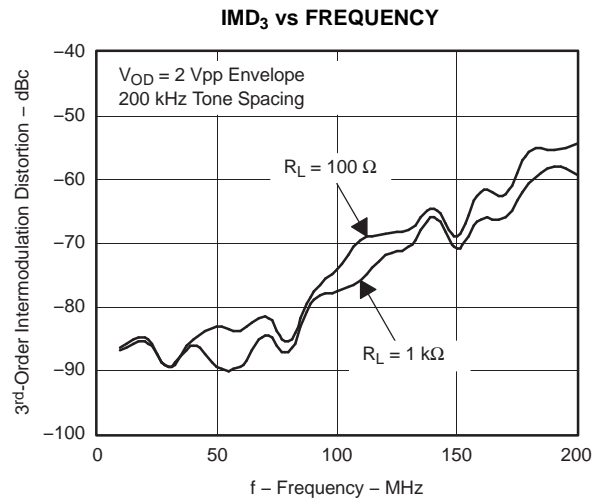

Figure 12.

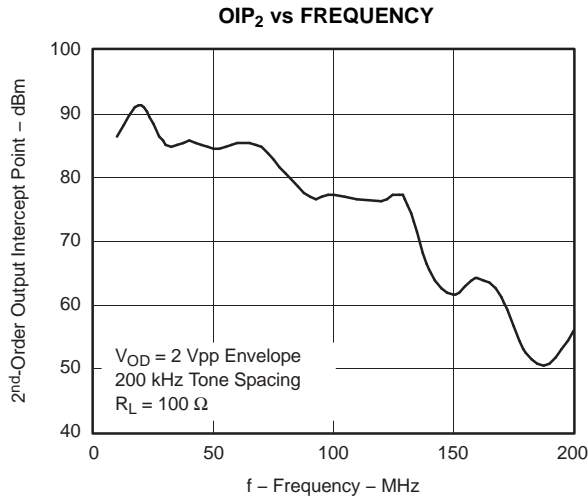

Figure 13.

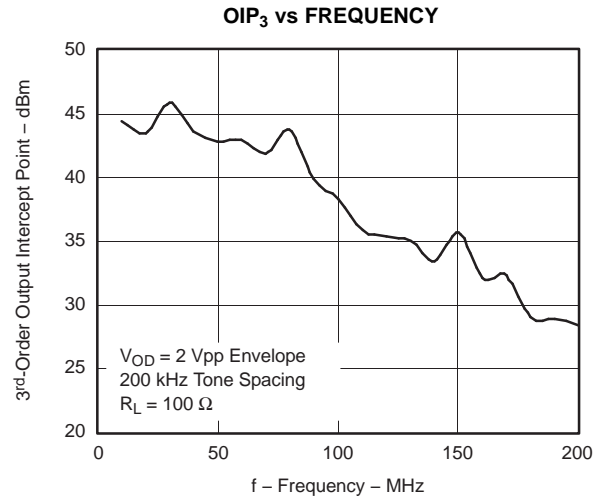

Figure 14.

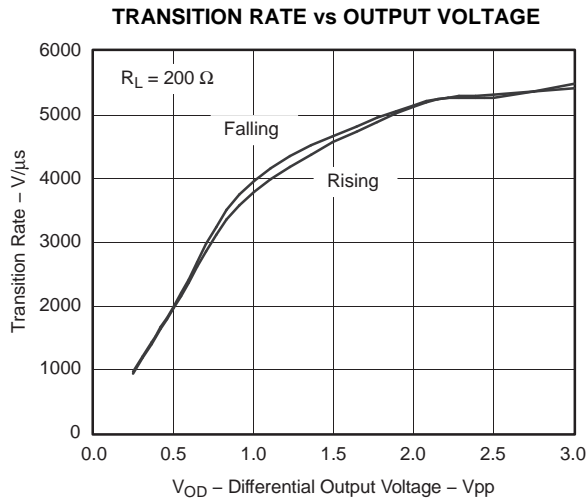

Figure 15.

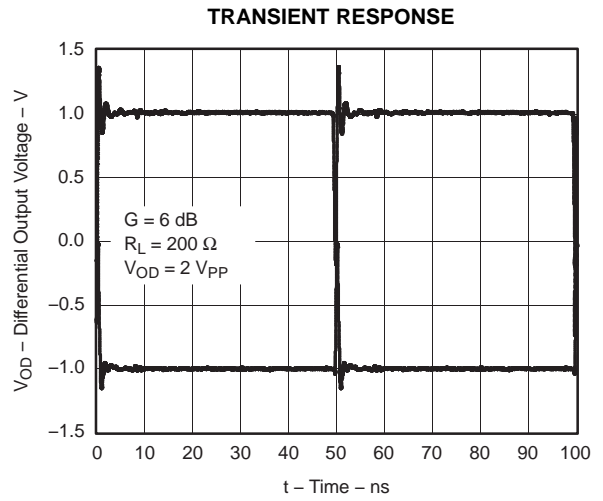

Figure 16.

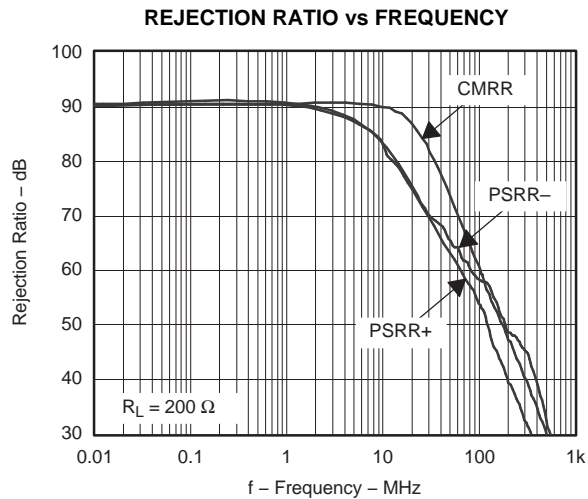

Figure 17.

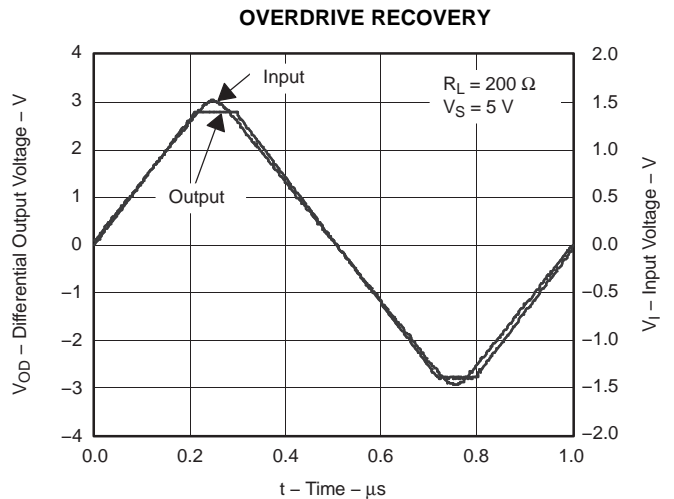

Figure 18.

OUTPUT VOLTAGE SWING vs LOAD RESISTANCE

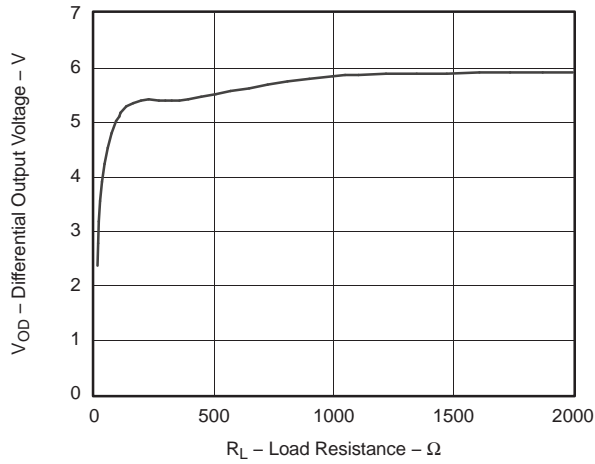

Figure 19.

TURN-OFF TIME

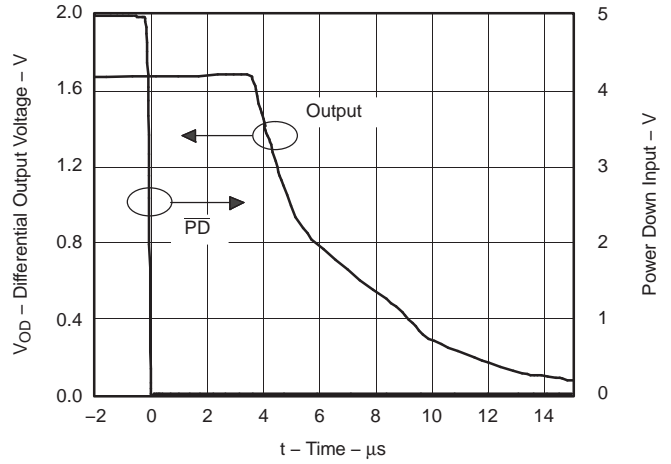

Figure 20.

TURN-ON TIME

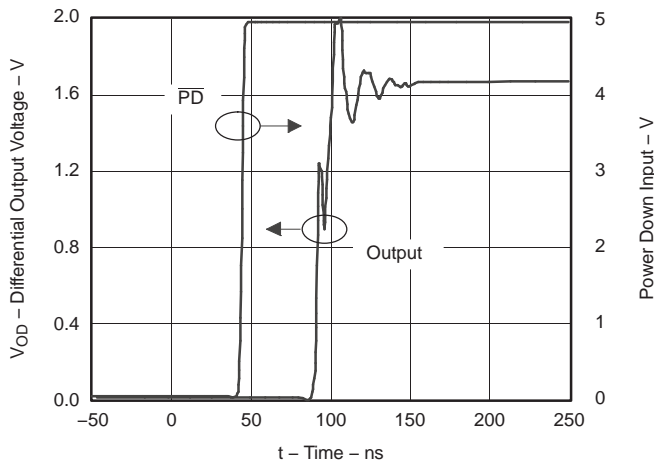

Figure 21.

INPUT OFFSET VOLTAGE vs COMMON-MODE INPUT VOLTAGE

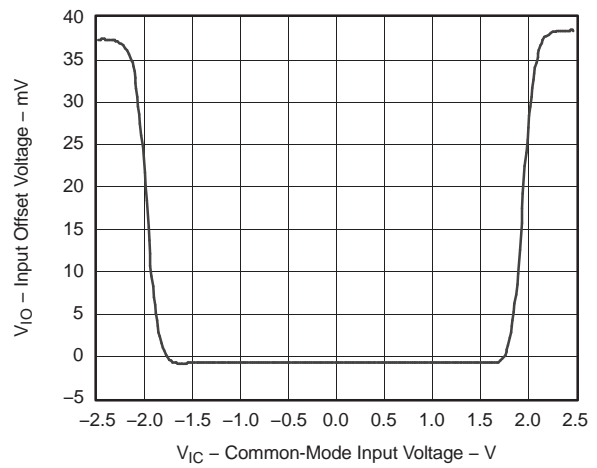

Figure 22.

INPUT REFERRED NOISE vs FREQUENCY

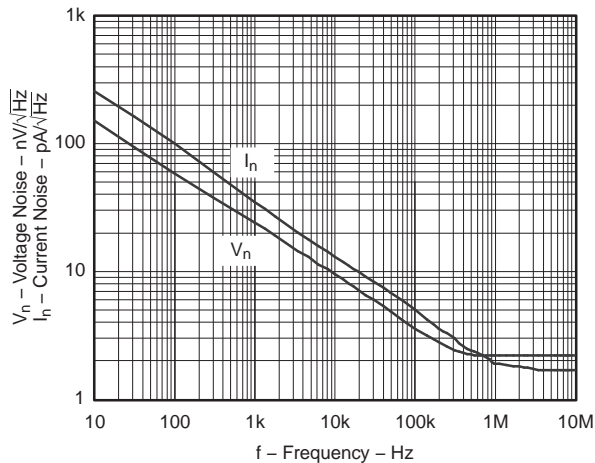

Figure 23.

NOISE FIGURE vs FREQUENCY

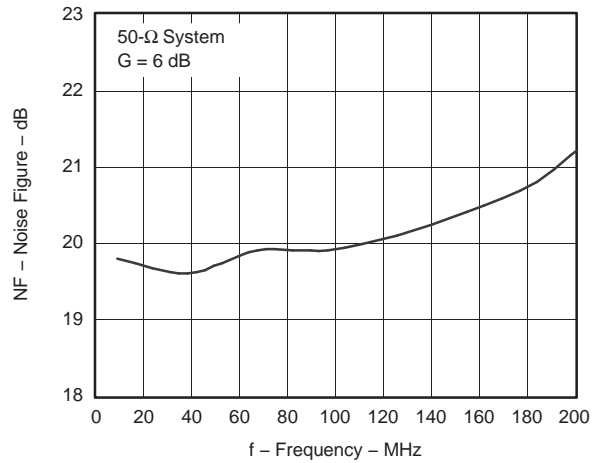

Figure 24.

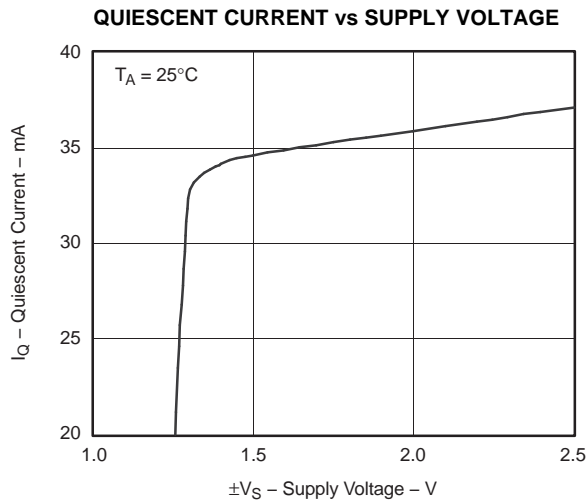

Figure 25.

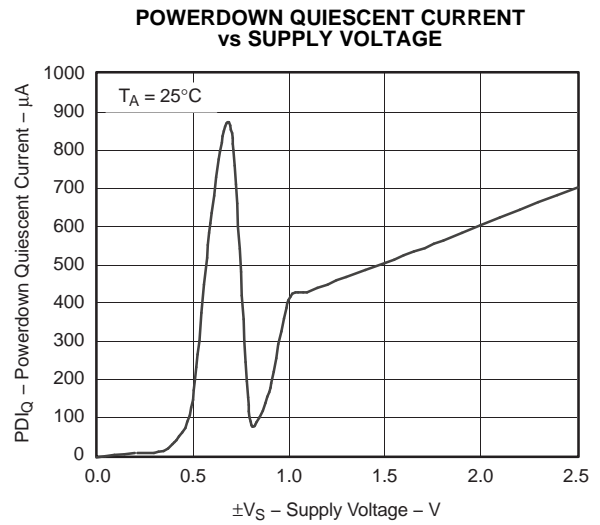

Figure 26.

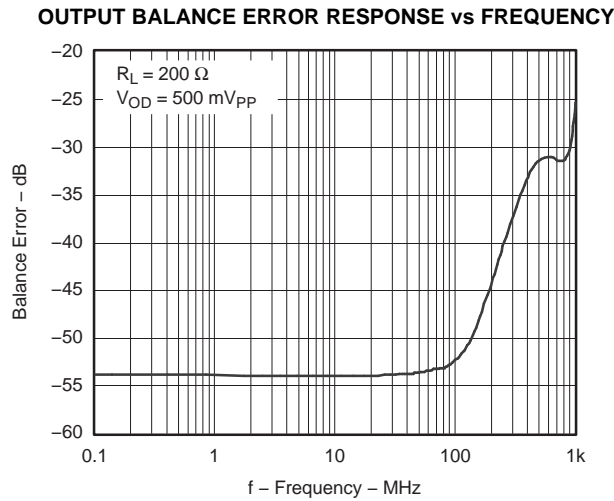

Figure 27.

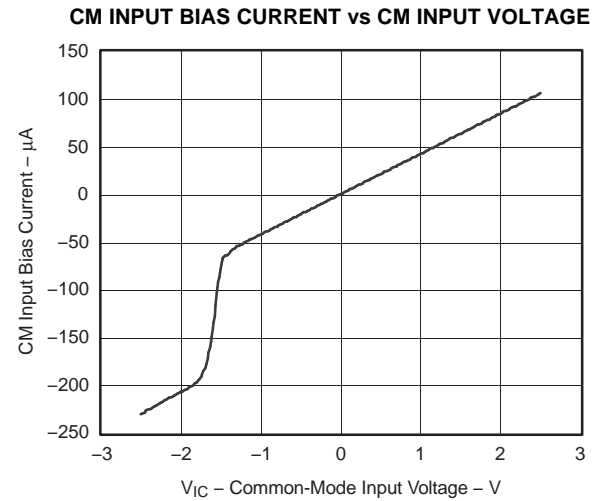

Figure 28.

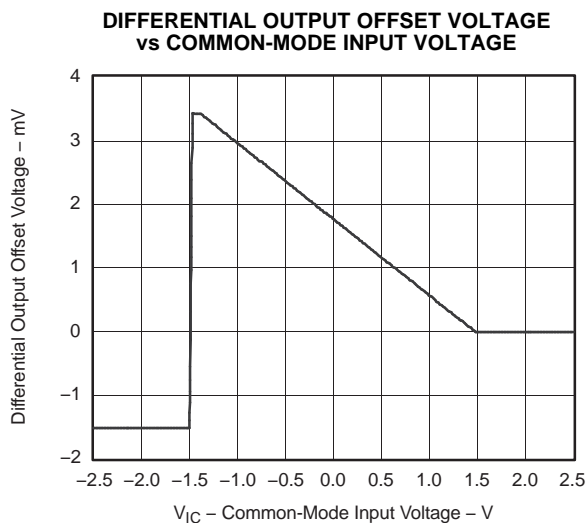

Figure 29.

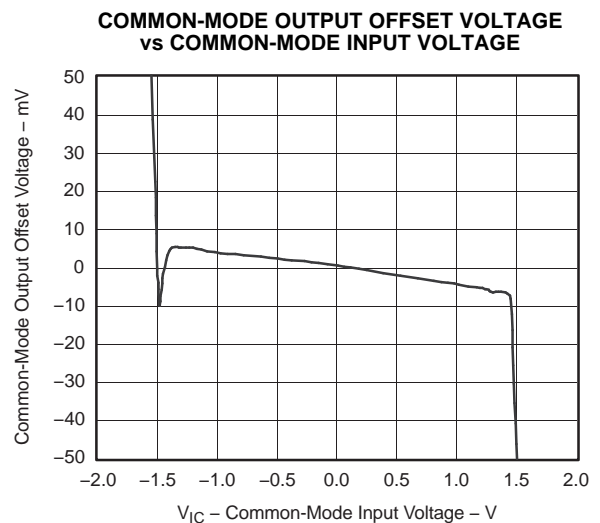

Figure 30.

TYPICAL AC PERFORMANCE: $V_{S+} - V_{S-} = 3\text{ V}$

Test conditions unless otherwise noted: $V_{S+} = +1.5\text{ V}$, $V_{S-} = -1.5\text{ V}$, CM = open, $V_{OD} = 1\text{ V}_{pp}$, $R_F = 348\ \Omega$, $R_L = 200\ \Omega$ Differential, G = 14 dB, Single-Ended Input, Input and Output Referenced to Mid-Supply

Small-Signal Frequency Response	G = 6 dB, $V_{OD} = 100\text{ mV}_{pp}$		Figure 31
	G = 10 dB, $V_{OD} = 100\text{ mV}_{pp}$		Figure 32
	G = 14 dB, $V_{OD} = 100\text{ mV}_{pp}$		Figure 33
Large Signal Frequency Response	G = 6 dB, $V_{OD} = 1\text{ V}_{pp}$		Figure 34
	G = 10 dB, $V_{OD} = 1\text{ V}_{pp}$		Figure 35
	G = 14 dB, $V_{OD} = 1\text{ V}_{pp}$		Figure 36
Harmonic Distortion	HD ₂ , G = 14 dB, $V_{OD} = 1\text{ V}_{pp}$	vs Frequency	Figure 37
	HD ₃ , G = 14 dB, $V_{OD} = 1\text{ V}_{pp}$	vs Frequency	Figure 38
	HD ₂ , G = 14 dB	vs Output Voltage	Figure 39
	HD ₃ , G = 14 dB	vs Output Voltage	Figure 40
Intermodulation Distortion	IMD ₂ , G = 14dB	vs Frequency	Figure 41
	IMD ₃ , G = 14 dB	vs Frequency	Figure 42
Output Intercept Point	OIP ₂	vs Frequency	Figure 43
	OIP ₃	vs Frequency	Figure 44
Transition Rate		vs Output Voltage	Figure 45
Transient Response			Figure 46
Rejection Ratio		vs Frequency	Figure 47
Output Voltage Swing		vs Load Resistance	Figure 48
Turn-Off Time			Figure 49
Turn-On Time			Figure 50
Noise Figure		vs Frequency	Figure 51
Output Balance Error		vs Frequency	Figure 52
Differential Output Offset Voltage		vs CM Input Voltage	Figure 53
Output Common-Mode Offset		vs CM Input Voltage	Figure 54

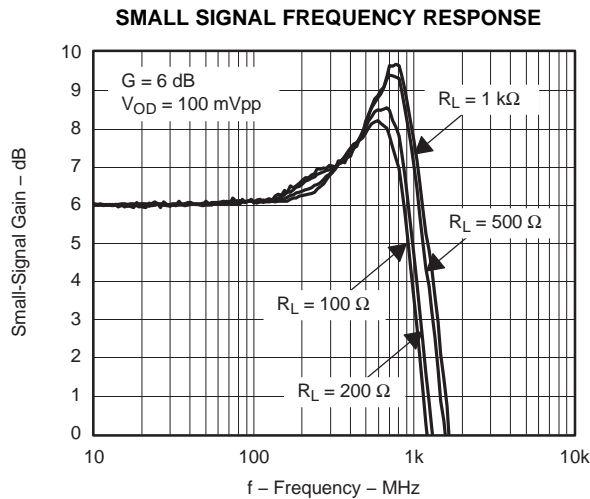

Figure 31.

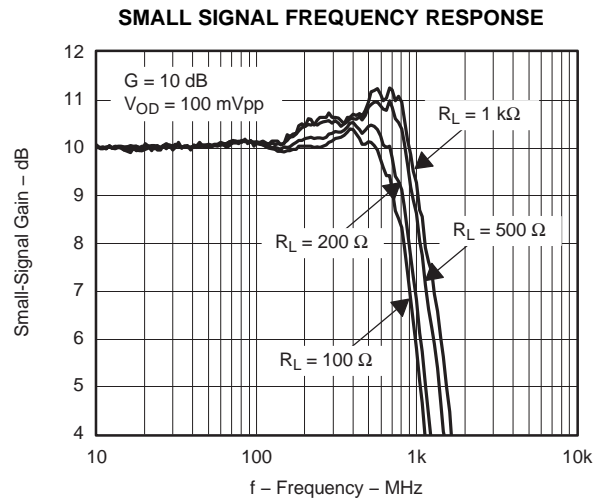

Figure 32.

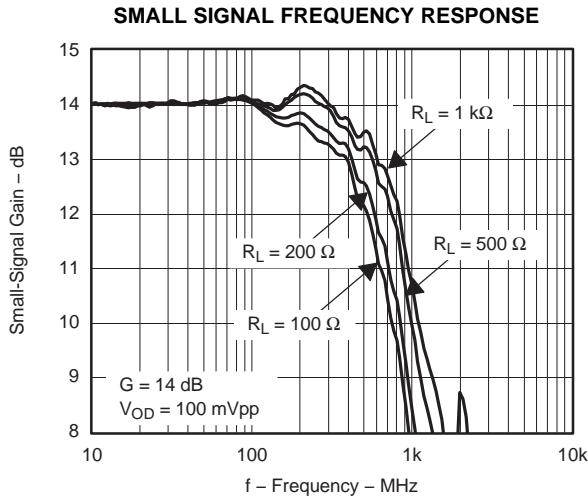

Figure 33.

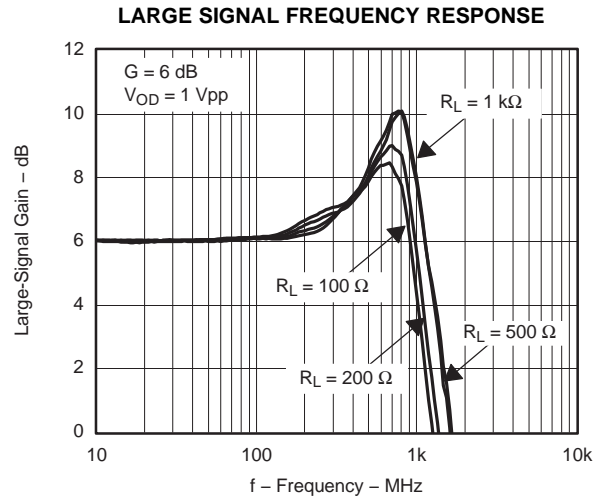

Figure 34.

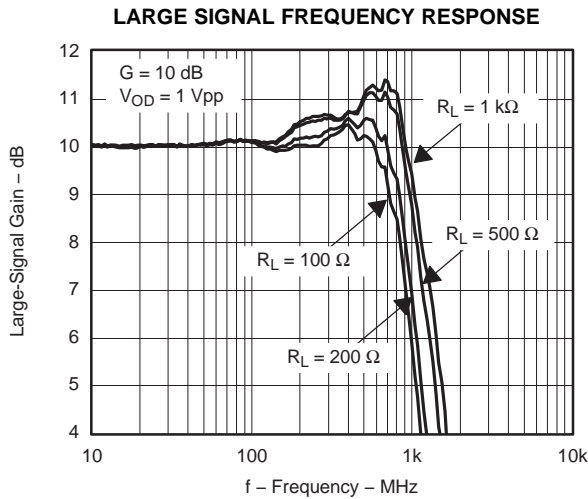

Figure 35.

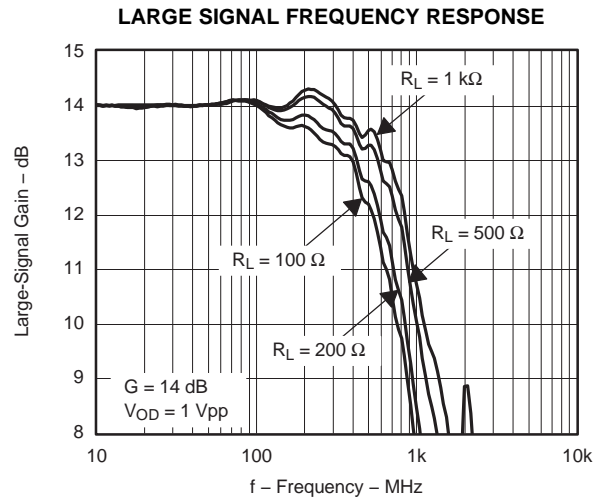

Figure 36.

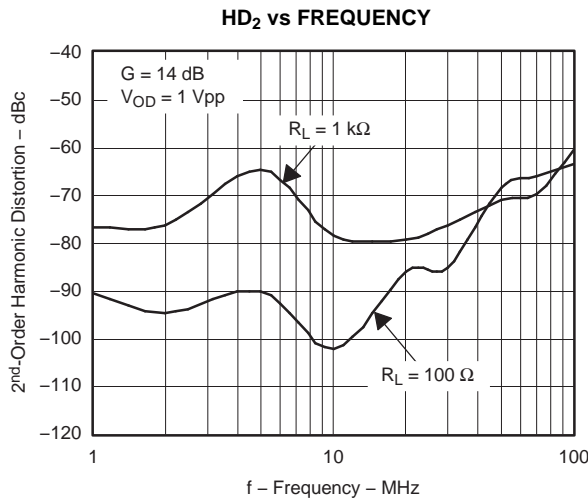

Figure 37.

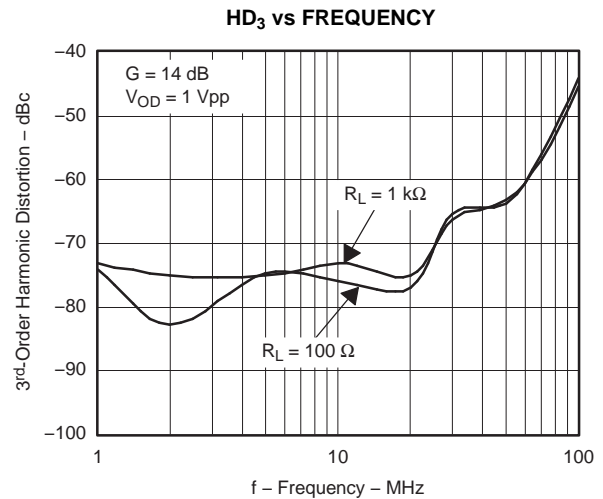

Figure 38.

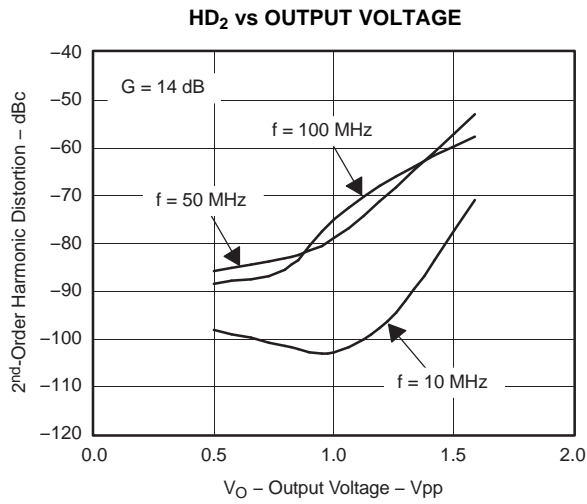

Figure 39.

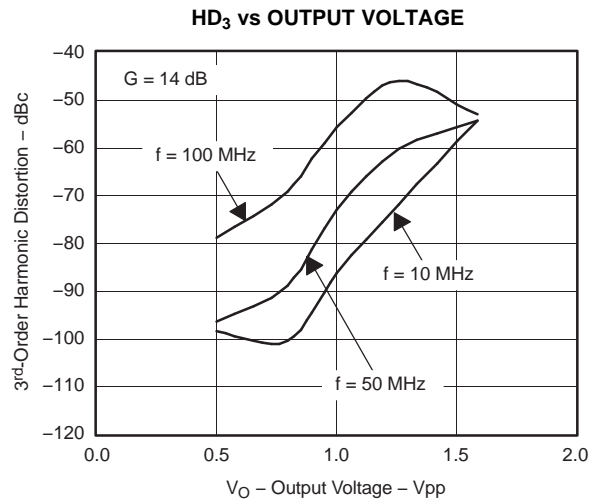

Figure 40.

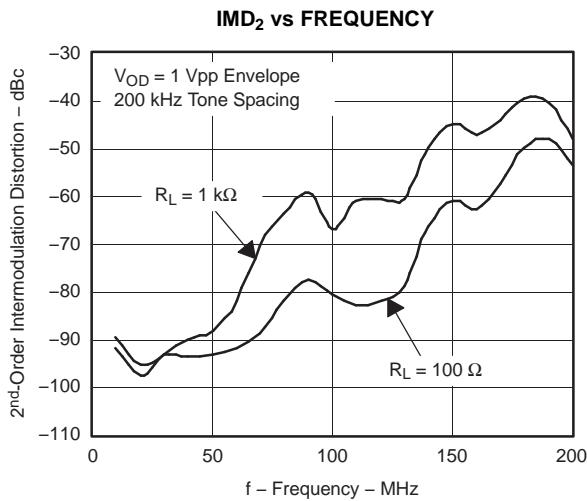

Figure 41.

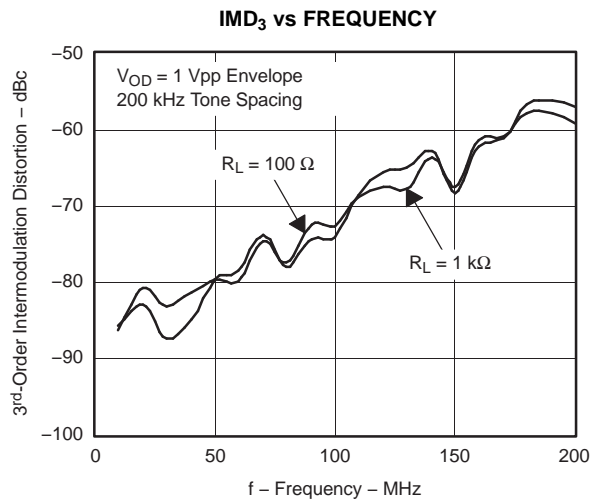

Figure 42.

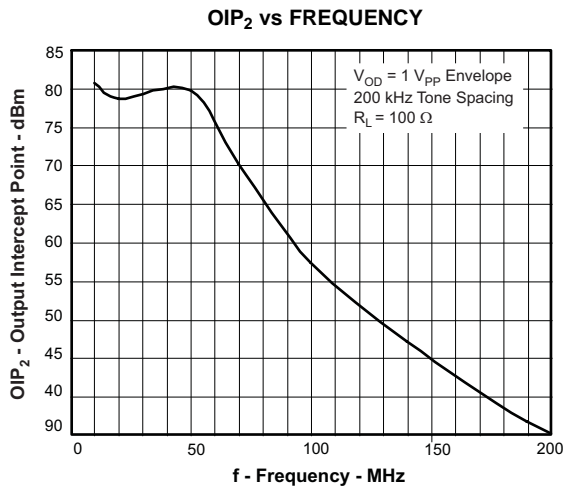

Figure 43.

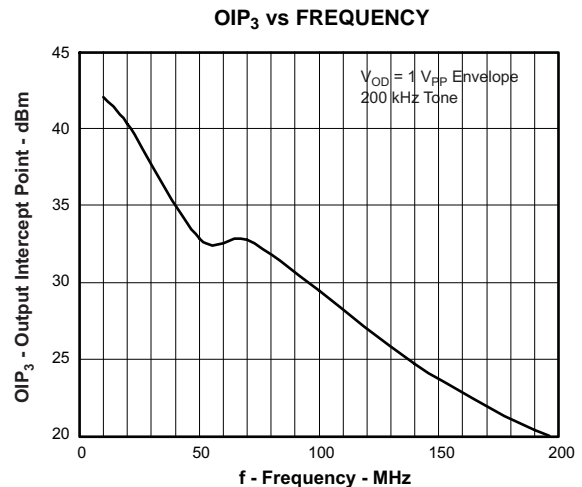

Figure 44.

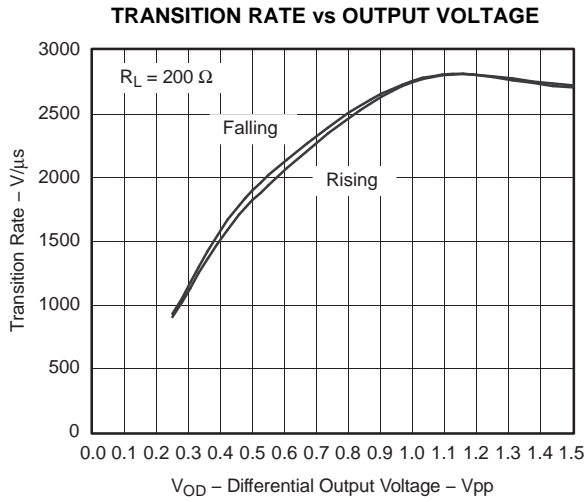

Figure 45.

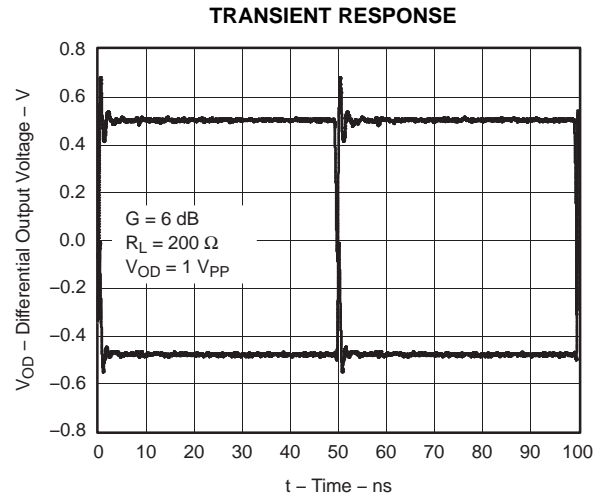

Figure 46.

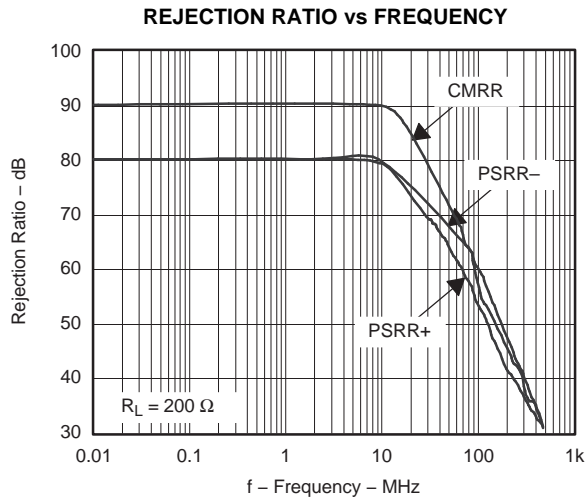

Figure 47.

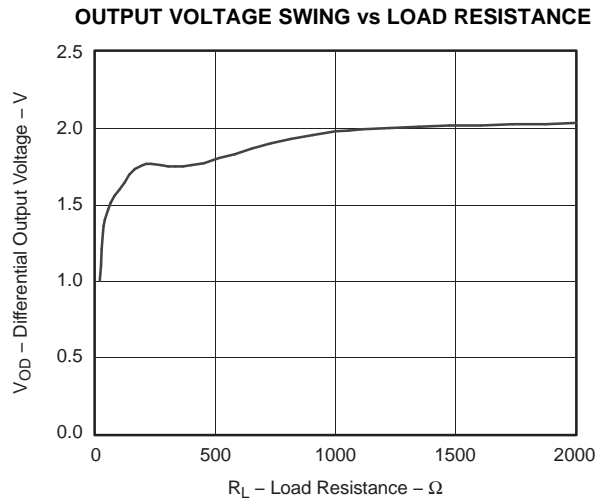

Figure 48.

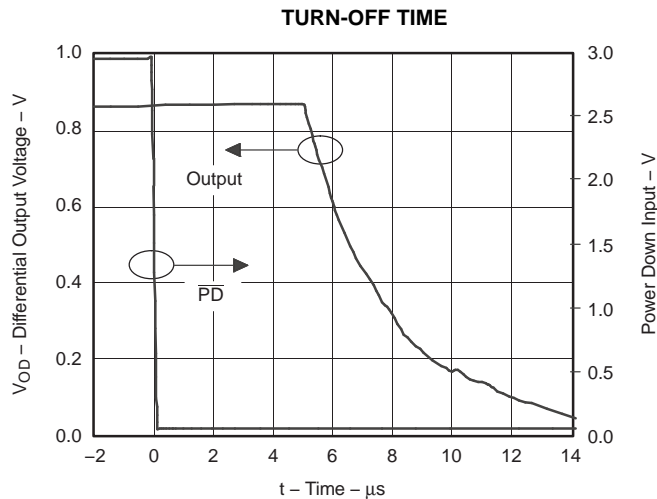

Figure 49.

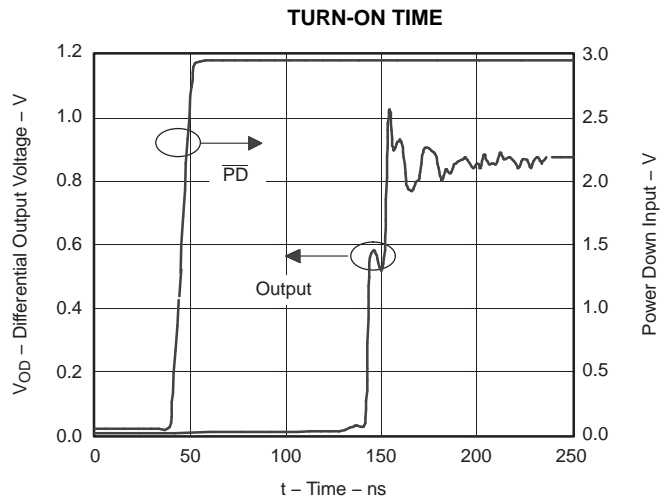

Figure 50.

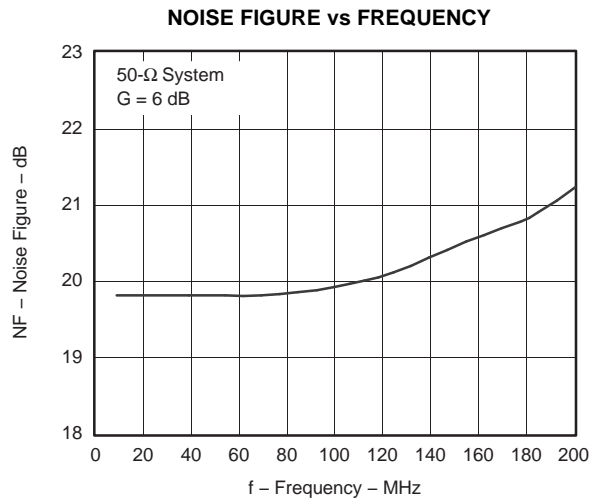

Figure 51.

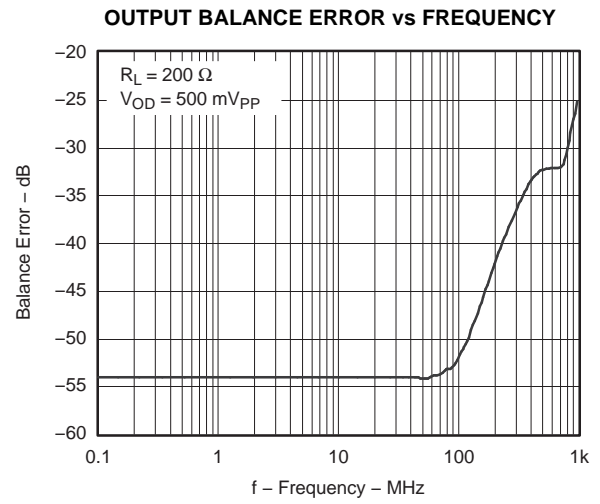

Figure 52.

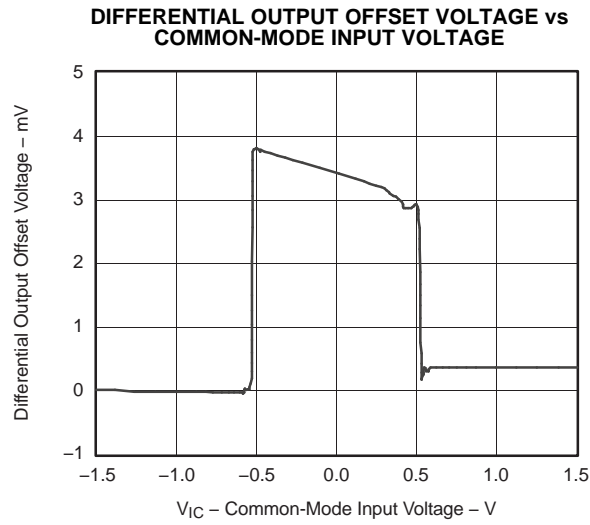

Figure 53.

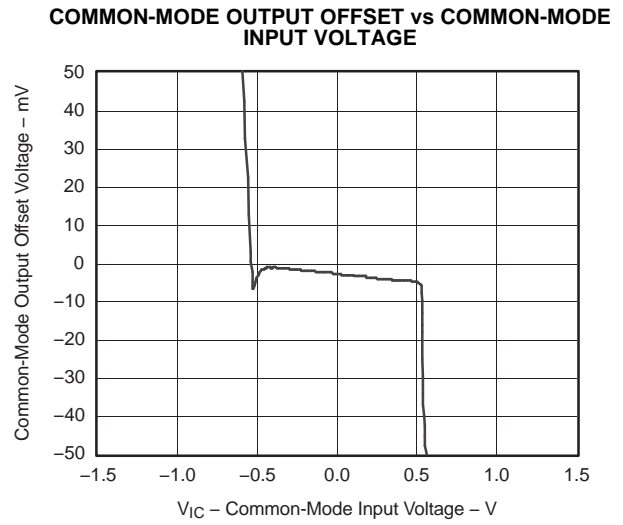

Figure 54.

TEST CIRCUITS

The THS4513 is characterized with the following test circuits. For simplicity, power supply decoupling is not shown – see layout in the *Application Information* section for recommendations. Depending on the test conditions, component values are changed per the following tables, or as otherwise noted. The signal generators used are ac coupled 50 Ω sources and a 0.22 μF capacitor and a 49.9 Ω resistor to ground are inserted across R_{IT} on the alternate input to balance the circuit. A split power supply is used to ease the interface to common test equipment, but the amplifier can be operated single-supply as described in the *Application Information* section with no impact on performance.

Table 1. Gain Component Values

GAIN	R_F	R_G	R_{IT}
6 dB	348 Ω	165 Ω	61.9 Ω
10 dB	348 Ω	100 Ω	69.8 Ω
14 dB	348 Ω	56.2 Ω	88.7 Ω
20 dB	348 Ω	16.5 Ω	287 Ω

Note: the gain setting includes 50 Ω source impedance. Components are chosen to achieve gain and 50 Ω input termination.

Table 2. Load Component Values

R_L	R_O	R_{OT}	Atten
100 Ω	25 Ω	open	6 dB
200 Ω	86.6 Ω	69.8 Ω	16.8 dB
499 Ω	237 Ω	56.2 Ω	25.5 dB
1k Ω	487 Ω	52.3 Ω	31.8 dB

Note: the total load includes 50 Ω termination by the test equipment. Components are chosen to achieve load and 50 Ω line termination through a 1:1 transformer.

Due to the voltage divider on the output formed by the load component values, the amplifier's output is attenuated. The column *Atten* in Table 2 shows the attenuation expected from the resistor divider. When using a transformer at the output as shown in Figure 56, the signal will see slightly more loss, and these numbers will be approximate.

Frequency Response

The circuit shown in Figure 55 is used to measure the frequency response of the circuit.

A network analyzer is used as the signal source and as the measurement device. The output impedance

of the network analyzer is 50 Ω . R_{IT} and R_G are chosen to impedance match to 50 Ω , and to maintain the proper gain. To balance the amplifier, a 0.22 μF capacitor and 49.9 Ω resistor to ground are inserted across R_{IT} on the alternate input.

The output is probed using a high-impedance differential probe across the 100 Ω resistor. The gain is referred to the amplifier output by adding back the 6-dB loss due to the voltage divider on the output.

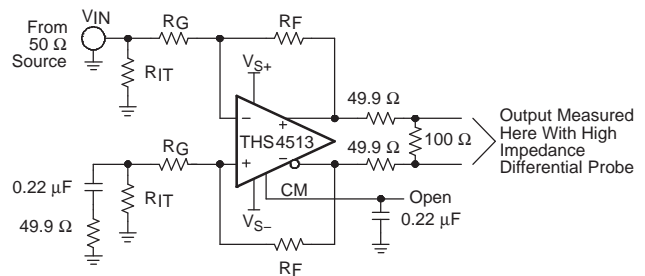

Figure 55. Frequency Response Test Circuit

Distortion

The circuit shown in Figure 56 is used to measure harmonic distortion and intermodulation distortion of the amplifier. A signal generator is used as the signal source and the output is measured with a spectrum analyzer. The output impedance of the signal generator is 50 Ω . R_{IT} and R_G are chosen to impedance-match to 50 Ω , and to maintain the proper gain. To balance the amplifier, a 0.22 μF capacitor and 49.9 Ω resistor to ground are inserted across R_{IT} on the alternate input.

A low-pass filter is inserted in series with the input to reduce harmonics generated at the signal source. The level of the fundamental is measured, then a high-pass filter is inserted at the output to reduce the fundamental so that it does not generate distortion in the input of the spectrum analyzer.

The transformer used in the output to convert the signal from differential to single ended is an ADT1-1WT. It limits the frequency response of the circuit so that measurements cannot be made below approximately 1 MHz.

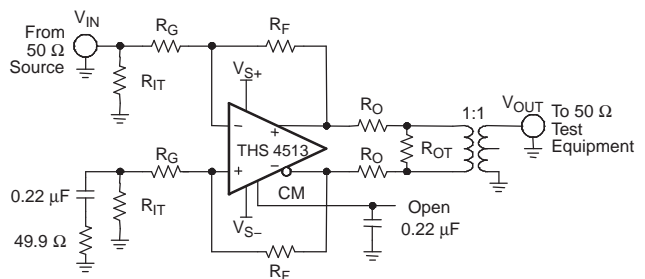

Figure 56. Distortion Test Circuit

Slew Rate, Transient Response, Settling Time, Output Impedance, Overdrive, Output Voltage, and Turn-On/Off Time

The circuit shown in Figure 57 is used to measure slew rate, transient response, settling time, output impedance, overdrive recovery, output voltage swing, and turn-on/turn-off times of the amplifier. For output impedance, the signal is injected at V_{OUT} with V_{IN} left open, and the drop across the 49.9 Ω resistor is used to calculate the impedance seen looking into the amplifier's output.

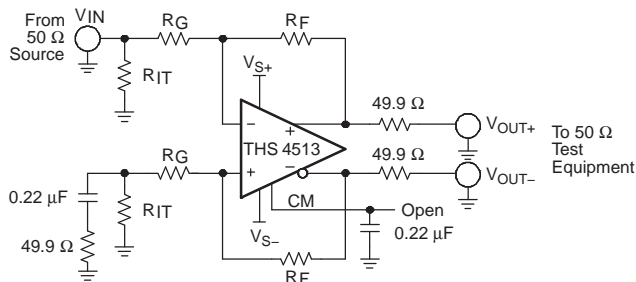

Figure 57. SR, Transient Response, Settling Time, Z_O , Overdrive Recovery, V_{OUT} Swing, and Turn-On/Off Test Circuit

CM Input

The circuit shown in Figure 58 is used to measure the frequency response and input impedance of the CM input. Frequency response is measured single-ended at V_{OUT+} or V_{OUT-} with the input injected at V_{IN} , $R_{CM} = 0 \Omega$ and $R_{CMT} = 49.9 \Omega$. The input impedance is measured with $R_{CM} = 49.9 \Omega$ with $R_{CMT} = \text{open}$, and calculated by measuring the voltage drop across R_{CM} to determine the input current.

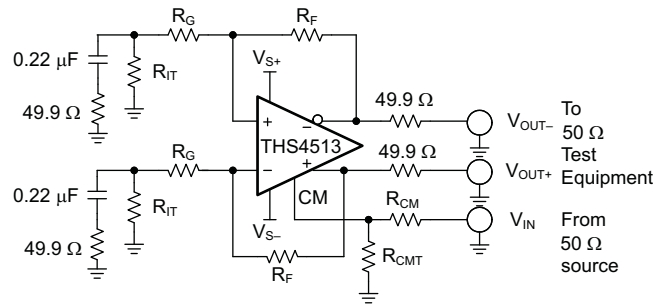

Figure 58. CM Input Test Circuit

CMRR and PSRR

The circuit shown in Figure 59 is used to measure the CMRR and PSRR of V_{S+} and V_{S-} . The input is switched appropriately to match the test being performed.

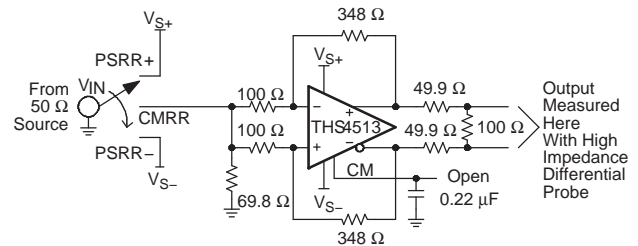

Figure 59. CMRR and PSRR Test Circuit

APPLICATION INFORMATION

APPLICATIONS

The following circuits show application information for the THS4513. For simplicity, power supply decoupling capacitors are not shown in these diagrams. Please see the THS4513 EVM section for recommendations. For more detail on the use and operation of fully differential op amps refer to application report *Fully-Differential Amplifiers* (SLOA054).

Differential Input to Differential Output Amplifier

The THS4513 is a fully differential op amp and can be used to amplify differential input signals to differential output signals. A basic block diagram of the circuit is shown in Figure 60 (CM input not shown). The gain of the circuit is set by R_F divided by R_G .

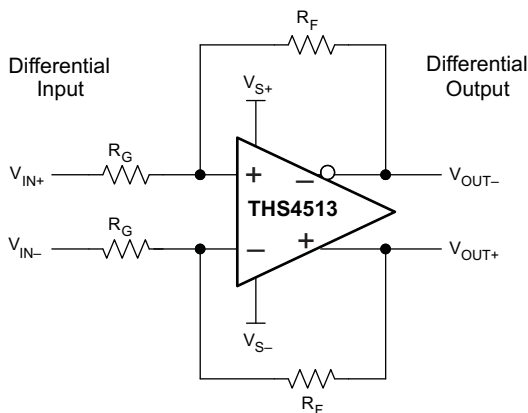

Figure 60. Differential Input to Differential Output Amplifier

Depending on the source and load, input and output termination can be accomplished by adding R_{IT} and R_O .

Single-Ended Input to Differential Output Amplifier

The THS4513 can be used to amplify and convert single-ended input signals to differential output signals. A basic block diagram of the circuit is shown in Figure 61 (CM input not shown). The gain of the circuit is again set by R_F divided by R_G .

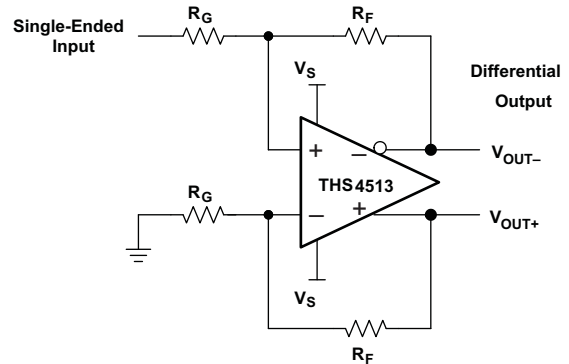

Figure 61. Single-Ended Input to Differential Output Amplifier

Input Common-Mode Voltage Range

The input common-mode voltage of a fully differential op amp is the voltage at the '+' and '-' input pins of the op amp.

It is important to not violate the input common-mode voltage range (V_{ICR}) of the op amp. Assuming the op amp is in linear operation, the voltage across the input pins is only a few millivolts at most. So finding the voltage at one input pin will determine the input common-mode voltage of the op amp.

Treating the negative input as a summing node, the voltage is given by Equation 1:

$$V_{IC} = \left(V_{OUT+} \times \frac{R_G}{R_G + R_F} \right) + \left(V_{IN-} \times \frac{R_F}{R_G + R_F} \right) \quad (1)$$

To determine the V_{ICR} of the op amp, the voltage at the negative input is evaluated at the extremes of V_{OUT+} .

As the gain of the op amp increases, the input common-mode voltage becomes closer and closer to the input common-mode voltage of the source.

Setting the Output Common-Mode Voltage

The output common-mode voltage is set by the voltage at the CM pin(s). The internal common-mode control circuit maintains the output common-mode voltage within 3 mV offset (typ) from the set voltage, when set within 0.5 V of mid-supply, with less than 4 mV differential offset voltage. If left unconnected, the common-mode set point is set to mid-supply by internal circuitry, which may be over-driven from an external source. Figure 62 is representative of the CM input. The internal CM circuit has about 700 MHz of -3 dB bandwidth, which is required for best

performance, but it is intended to be a DC bias input pin. Bypass capacitors are recommended on this pin to reduce noise at the output. The external current required to overdrive the internal resistor divider is given by Equation 2:

$$I_{EXT} = \frac{2V_{CM} - (V_{S+} - V_{S-})}{50\text{ k}\Omega} \quad (2)$$

where V_{CM} is the voltage applied to the CM pin.

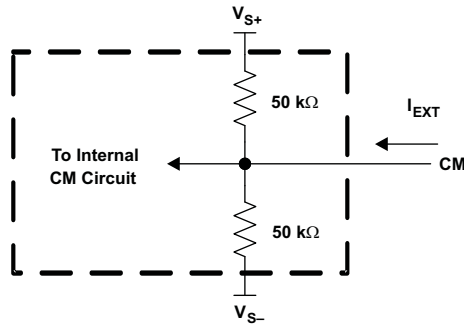

Figure 62. CM Input Circuit

Single-Supply Operation (3 V to 5 V)

To facilitate testing with common lab equipment, the THS4513 EVM allows split-supply operation, and the characterization data presented in this data sheet was taken with split-supply power inputs. The device easily can be used with a single-supply power input without degrading the performance. Figure 63, Figure 64, and Figure 65 show DC and AC-coupled single-supply circuits with single-ended inputs. These configurations all allow the input and output common-mode voltage to be set to mid-supply allowing for optimum performance. The information presented here also can be applied to differential input sources.

In Figure 63, the signal source is referenced to a voltage derived from the CM pin via a unity-gain wideband buffer such as the BUF602. V_{CM} is set to mid-supply by THS4513 internal circuitry. R_T along with the input impedance of the amplifier provides input termination, which also is referenced to V_{CM} .

Note that R_S and R_T are added to the alternate input from the signal input to balance the amplifier. Alternately, one resistor can be used equal to the combined value $R_G + R_S || R_T$ on this input. This is also true of the circuits shown in Figure 64 and Figure 65.

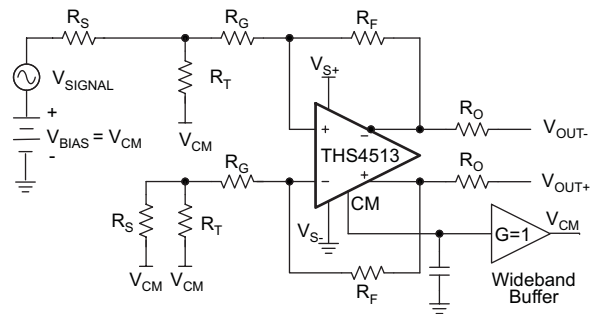

Figure 63. THS4513 DC Coupled Single-Supply with Input Biased to V_{CM}

In Figure 64 the source is referenced to ground and so is the input termination resistor. R_{PU} is added to the circuit to avoid violating the V_{ICR} of the op amp. The proper value of resistor to add can be calculated from Equation 3:

$$R_{PU} = \frac{(V_{IC} - V_{S+})}{V_{CM} \left(\frac{1}{R_F} \right) - V_{IC} \left(\frac{1}{R_{IN}} + \frac{1}{R_F} \right)} \quad (3)$$

V_{IC} is the desired input common-mode voltage, $V_{CM} = V_{CM}$, and $R_{IN} = R_G + R_S || R_T$. To set to mid-supply, make the value of $R_{PU} = R_G + R_S || R_T$.

Table 3 is a modification of Table 1 to add the proper values with R_{PU} assuming a 50 Ω source impedance and setting the input and output common-mode voltage to mid-supply.

There are two drawbacks to this configuration. One is that it requires additional current from the power supply. Using the values shown for a gain of 10 dB requires 37 mA more current with 5 V supply, and 22 mA more current with 3 V supply.

The other drawback is this configuration also increases the noise gain of the circuit. In the 10 dB gain case, noise gain increases by a factor of 1.5.

Table 3. RPU Values for Various Gains

Gain	R_F	R_G	R_{IT}	R_{PU}
6 dB	348 Ω	169 Ω	64.9 Ω	200 Ω
10 dB	348 Ω	102 Ω	78.7 Ω	133 Ω
14 dB	348 Ω	61.9 Ω	115 Ω	97.6 Ω
20 dB	348 Ω	40.2 Ω	221 Ω	80.6 Ω

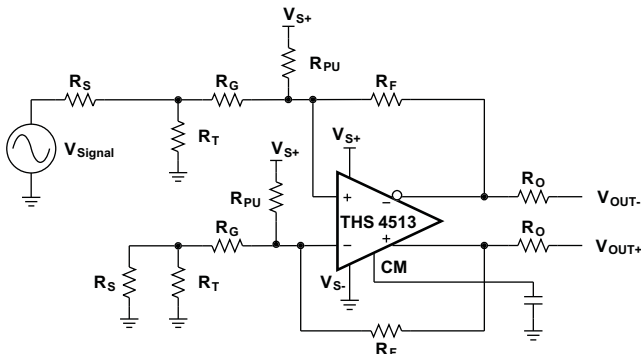

Figure 64. THS4513 DC Coupled Single-Supply With R_{PU} Used to Set V_{IC}

Figure 65 shows AC coupling to the source. Using capacitors in series with the termination resistors allows the amplifier to self-bias both input and output to mid-supply.

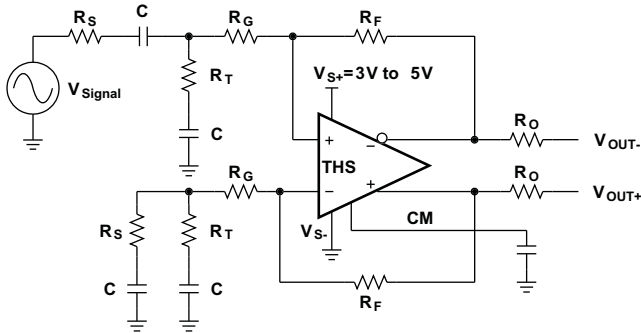

Figure 65. THS4513 AC Coupled Single-Supply

THS4513 + ADS5500 Combined Performance

The THS4513 is designed to be a high-performance drive amplifier for high-performance data converters like the ADS5500 14 bit 125 MSPS ADC. Figure 66 shows a circuit combining the two devices. The THS4513 amplifier circuit provides 10 dB of gain, converts the single-ended input to differential, and sets the proper input common-mode voltage to the ADS5500. The 100 Ω resistors and 2.7 pF capacitor between the THS4513 outputs and ADS5500 inputs, along with the input capacitance of the ADS5500, limit the bandwidth of the signal to 115 MHz (-3 dB). For testing, a signal generator is used for the signal source. The generator is an AC-coupled 50 Ω source. A band-pass filter is inserted in series with the input to reduce harmonics and noise from the signal source. Input termination is accomplished via the 69.8 Ω resistor and 0.22 μ F capacitor to ground in conjunction with the input impedance of the amplifier circuit. A 0.22 μ F capacitor and 49.9 Ω resistor is inserted to ground across the 69.8 Ω resistor and 0.22 μ F capacitor on the alternate input to balance the circuit. Gain is a function of the source

impedance, termination, and 348 Ω feedback resistor. Refer to Table 3 for component values to set proper 50 Ω termination for other common gains. A split power supply of 4 V and -1 V is used to set the input and output common-mode voltages to approximately mid-supply while setting the input common-mode of the ADS5500 to the recommended 1.55 V. This maintains maximum headroom on the internal transistors of the THS4513 to ensure optimum performance.

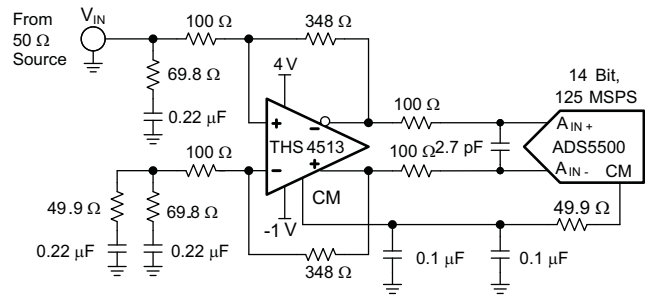

Figure 66. THS4513 + ADS5500 Circuit

Figure 67 shows the 2-tone FFT of the THS4513 + ADS5500 circuit with 65 MHz and 70 MHz input frequencies. The SFDR is 90 dBc.

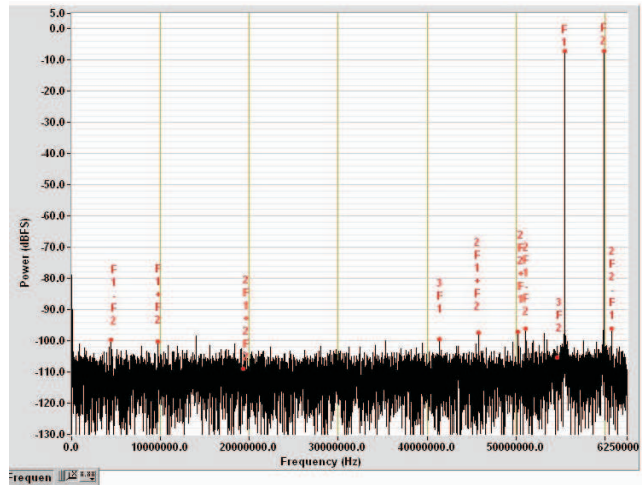

Figure 67. THS4513 + ADS5500 2-Tone FFT With 65 MHz and 70 MHz Input

THS4513 + ADS5424 Combined Performance

Figure 68 shows the THS4513 driving the ADS5424 ADC.

The THS4513 amplifier provides 10 dB of gain, converts the single-ended input to differential, and sets the proper input common-mode voltage to the ADS5424. Input termination and circuit testing is the same as described above for the THS4513 + ADS5500 circuit.

The 225 Ω resistors and 2.7 pF capacitor between the THS4513 outputs and ADS5424 inputs (along with the input capacitance of the ADC) limit the bandwidth of the signal to about 100 MHz (−3 dB).

Because the ADS5424s recommended input common-mode voltage is 2.4 V, the THS4513 is operated from a single power supply input with $V_{S+} = 5\text{ V}$ and $V_{S-} = 0\text{ V}$ (ground).

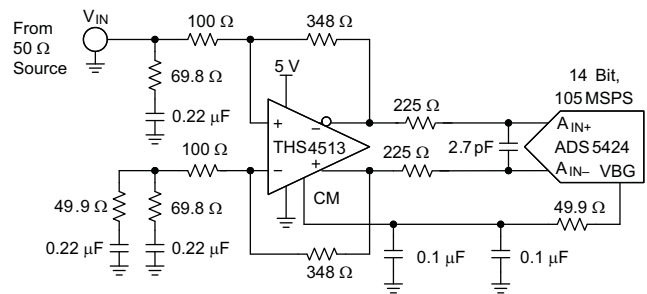

Figure 68. THS4513 + ADS5424 Circuit

Layout Recommendations

It is recommended to follow the layout of the external components near the amplifier, ground plane construction, and power routing of the EVM as closely as possible. General guidelines are:

1. Signal routing should be direct and as short as possible into and out of the opamp circuit.
2. The feedback path should be short and direct avoiding vias.
3. Ground or power planes should be removed from directly under the amplifier's input and output pins.
4. An output resistor is recommended on each output, as near to the output pin as possible.
5. Two 10 μF and two 0.1 μF power-supply decoupling capacitors should be placed as near the power-supply pins as possible.
6. Two 0.1 μF capacitors should be placed between the CM input pins and ground. This limits noise coupled into the pins. One each should be placed to ground near pin 4 and pin 9.
7. It is recommended to split the ground plane on layer 2 (L2) as shown below and to use a solid ground on layer 3 (L3). A single-point connection should be used between each split section on L2 and L3.
8. A single-point connection to ground on L2 is recommended for the input termination resistors R1 and R2. This should be applied to the input gain resistors if termination is not used.

THS4513 EVM

Figure 69 is the THS4513 EVAL1 EVM schematic for the plastic QFN (RGT) package. Layers 1 through 4 of the PCB are shown in Figure 70, and Table 4 is the bill of materials for the EVM as supplied from TI. The same layout recommendations should be followed for the THS4513 ceramic flatpack devices. Contact your TI representative for availability of the THS4513 EVM.

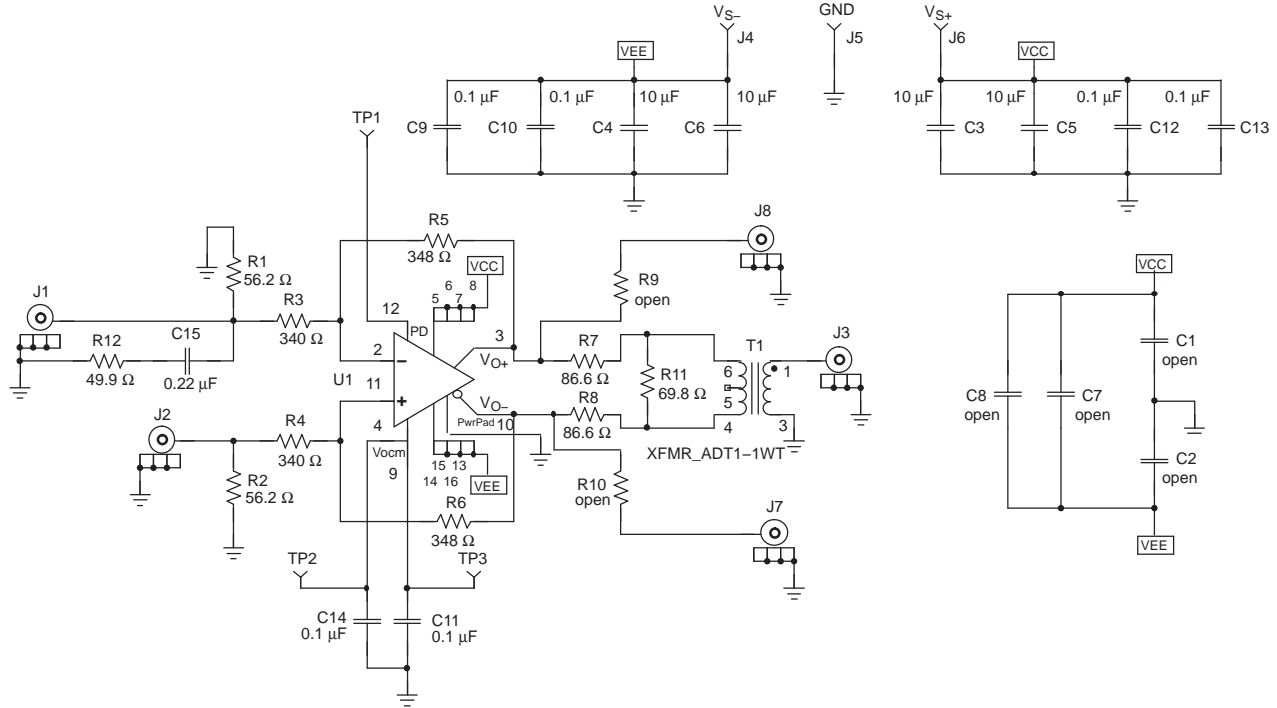

Figure 69. THS4513 EVAL1 EVM Schematic

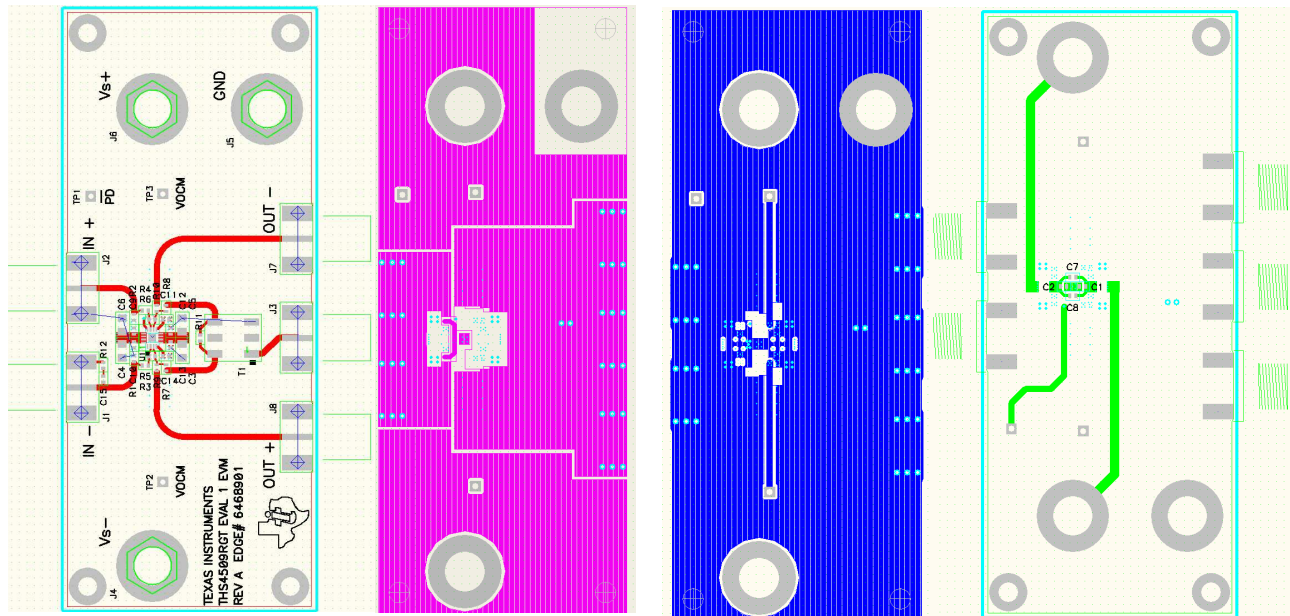



Figure 70. THS4513 EVAL1 EVM Layer 1 Through 4

Table 4. THS4513 EVAL1 EVM Bill of Materials

ITEM	DESCRIPTION	SMD SIZE	REFERENCE DESIGNATOR	PCB QTY	MANUFACTURER'S PART NUMBER
1	CAP, 10.0 μ F, Ceramic, X5R, 6.3 V	0805	C3, C4, C5, C6	4	(AVX) 08056D106KAT2A
2	CAP, 0.1 μ F, Ceramic, X5R, 10 V	0402	C9, C10, C11, C12, C13, C14	6	(AVX) 0402ZD104KAT2A
3	CAP, 0.22 μ F, Ceramic, X5R, 6.3 V	0402	C15	1	(AVX) 04026D224KAT2A
4	OPEN	0402	C1, C2, C7, C8	4	
5	OPEN	0402	R9, R10	2	
6	Resistor, 49.9 Ω , 1/16W, 1%	0402	R12	1	(KOA) RK73H1ETTP49R9F
7	Resistor, 56.2 Ω , 1/16W, 1%	0402	R1,R2	2	(KOA) RK73H1ETTP56R2F
8	Resistor, 69.8 Ω , 1/16W, 1%	0402	R11	1	(KOA) RK73H1ETTP69R8F
9	Resistor, 86.6 Ω , 1/16W, 1%	0402	R7, R8	2	(KOA) RK73H1ETTP86R6F
10	Resistor, 340 Ω , 1/16W, 1%	0402	R3, R4	2	(KOA) RK73H1ETTP3400F
11	Resistor, 348 Ω , 1/16W, 1%	0402	R5, R6	2	(KOA) RK73H1ETTP3480F
12	Transformer, RF		T1	1	(MINI-CIRCUITS) ADT1-1WT
13	Jack, banana receptance, 0.25" diameter hole		J4, J5, J6	3	(HH SMITH) 101
14	OPEN		J1, J7, J8	3	
15	Connector, edge, SMA PCB Jack		J2, J3	2	(JOHNSON) 142-0701-801
16	Test point, Red		TP1, TP2, TP3	3	(KEYSTONE) 5000
17	IC, THS4513		U1	1	(TI) THS4513RGT
18	Standoff, 4-40 HEX, 0.625" length			4	(KEYSTONE) 1808
19	Screw, Phillips, 4-40, 0.250"			4	SHR-0440-016-SN
20	Printed circuit board			1	(TI) EDGE# 6475514

PACKAGING INFORMATION

Orderable Device	Status (1)	Package Type	Package Drawing	Pins	Package Qty	Eco Plan (2)	Lead finish/ Ball material (6)	MSL Peak Temp (3)	Op Temp (°C)	Device Marking (4/5)	Samples
5962-0722301VFA	ACTIVE	CFP	HKT	16	1	Non-RoHS & Green	Call TI	N / A for Pkg Type	-55 to 125	5962-0722301VF A THS4513M	
THS4513HKT/EM	ACTIVE	CFP	HKT	16	1	RoHS & Green	Call TI	N / A for Pkg Type	25 to 25	THS4513HKT/EM EVAL ONLY	

(1) The marketing status values are defined as follows:

ACTIVE: Product device recommended for new designs.

LIFEBUY: TI has announced that the device will be discontinued, and a lifetime-buy period is in effect.

NRND: Not recommended for new designs. Device is in production to support existing customers, but TI does not recommend using this part in a new design.

PREVIEW: Device has been announced but is not in production. Samples may or may not be available.

OBSELETE: TI has discontinued the production of the device.

(2) **RoHS:** TI defines "RoHS" to mean semiconductor products that are compliant with the current EU RoHS requirements for all 10 RoHS substances, including the requirement that RoHS substance do not exceed 0.1% by weight in homogeneous materials. Where designed to be soldered at high temperatures, "RoHS" products are suitable for use in specified lead-free processes. TI may reference these types of products as "Pb-Free".

RoHS Exempt: TI defines "RoHS Exempt" to mean products that contain lead but are compliant with EU RoHS pursuant to a specific EU RoHS exemption.

Green: TI defines "Green" to mean the content of Chlorine (Cl) and Bromine (Br) based flame retardants meet JS709B low halogen requirements of <=1000ppm threshold. Antimony trioxide based flame retardants must also meet the <=1000ppm threshold requirement.

(3) MSL, Peak Temp. - The Moisture Sensitivity Level rating according to the JEDEC industry standard classifications, and peak solder temperature.

(4) There may be additional marking, which relates to the logo, the lot trace code information, or the environmental category on the device.

(5) Multiple Device Markings will be inside parentheses. Only one Device Marking contained in parentheses and separated by a "~" will appear on a device. If a line is indented then it is a continuation of the previous line and the two combined represent the entire Device Marking for that device.

(6) Lead finish/Ball material - Orderable Devices may have multiple material finish options. Finish options are separated by a vertical ruled line. Lead finish/Ball material values may wrap to two lines if the finish value exceeds the maximum column width.

Important Information and Disclaimer:The information provided on this page represents TI's knowledge and belief as of the date that it is provided. TI bases its knowledge and belief on information provided by third parties, and makes no representation or warranty as to the accuracy of such information. Efforts are underway to better integrate information from third parties. TI has taken and continues to take reasonable steps to provide representative and accurate information but may not have conducted destructive testing or chemical analysis on incoming materials and chemicals. TI and TI suppliers consider certain information to be proprietary, and thus CAS numbers and other limited information may not be available for release.

In no event shall TI's liability arising out of such information exceed the total purchase price of the TI part(s) at issue in this document sold by TI to Customer on an annual basis.

OTHER QUALIFIED VERSIONS OF THS4513-SP :

- Catalog : [THS4513](#)

NOTE: Qualified Version Definitions:

- Catalog - TI's standard catalog product

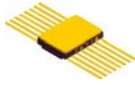

PACKAGE OUTLINE

HKT0016A

CFP - 2.13 mm max height

CERAMIC DUAL FLATPACK

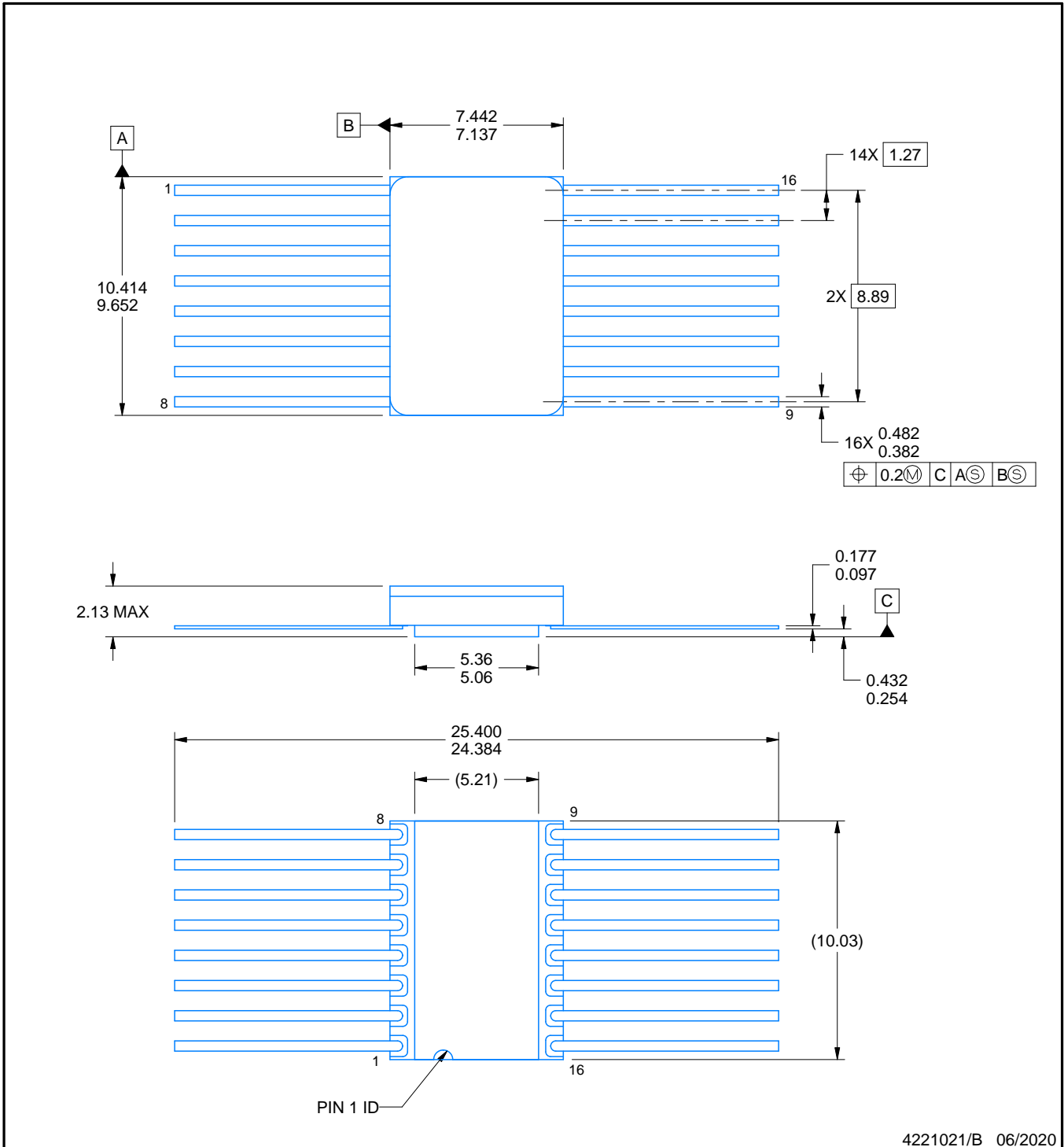

4221021/B 06/2020

NOTES:

1. All linear dimensions are in millimeters. Any dimensions in parenthesis are for reference only. Dimensioning and tolerancing per ASME Y14.5M.
2. This drawing is subject to change without notice.
3. This package is hermetically sealed with a metal lid. Lid and cavity are electrically isolated
4. The terminals are gold plated.
5. Falls within MIL-STD-1835 CDFP-F11A.

IMPORTANT NOTICE AND DISCLAIMER

TI PROVIDES TECHNICAL AND RELIABILITY DATA (INCLUDING DATASHEETS), DESIGN RESOURCES (INCLUDING REFERENCE DESIGNS), APPLICATION OR OTHER DESIGN ADVICE, WEB TOOLS, SAFETY INFORMATION, AND OTHER RESOURCES "AS IS" AND WITH ALL FAULTS, AND DISCLAIMS ALL WARRANTIES, EXPRESS AND IMPLIED, INCLUDING WITHOUT LIMITATION ANY IMPLIED WARRANTIES OF MERCHANTABILITY, FITNESS FOR A PARTICULAR PURPOSE OR NON-INFRINGEMENT OF THIRD PARTY INTELLECTUAL PROPERTY RIGHTS.

These resources are intended for skilled developers designing with TI products. You are solely responsible for (1) selecting the appropriate TI products for your application, (2) designing, validating and testing your application, and (3) ensuring your application meets applicable standards, and any other safety, security, or other requirements. These resources are subject to change without notice. TI grants you permission to use these resources only for development of an application that uses the TI products described in the resource. Other reproduction and display of these resources is prohibited. No license is granted to any other TI intellectual property right or to any third party intellectual property right. TI disclaims responsibility for, and you will fully indemnify TI and its representatives against, any claims, damages, costs, losses, and liabilities arising out of your use of these resources.

TI's products are provided subject to TI's Terms of Sale (<https://www.ti.com/legal/termsofsale.html>) or other applicable terms available either on [ti.com](https://www.ti.com) or provided in conjunction with such TI products. TI's provision of these resources does not expand or otherwise alter TI's applicable warranties or warranty disclaimers for TI products.

Mailing Address: Texas Instruments, Post Office Box 655303, Dallas, Texas 75265
Copyright © 2021, Texas Instruments Incorporated