

# TIG067SS



## IGBT

400V, 150A, VCE(sat);3.8V Single N-Channel

ON Semiconductor®

www.onsemi.com

### Features

- Low-saturation Voltage
- Enhancement Type
- High Speed Switching
- 4.0V Drive
- Built-in Gate-to-Emitter Protection Diode
- Pb-Free, Halogen Free and RoHS Compliance

### Applications

- Light-controlling Flash

### Specifications

Absolute Maximum Ratings at Ta=25°C

Parameter	Symbol	Conditions	Ratings	Unit
Collector-to-Emitter Voltage (DC)	V <sub>CES</sub>		400	V
Collector-to-Emitter Voltage (Pulse)	V <sub>CESP</sub>	PW≤1ms	450	V
Gate-to-Emitter Voltage (DC)	V <sub>GES</sub>		±6	V
Gate-to-Emitter Voltage (Pulse)	V <sub>GESP</sub>	PW≤1ms	±8	V
Collector Current (Pulse)	I <sub>CP</sub>	C <sub>M</sub> =600μF	150	A
Maximum Collector-to-Emitter dv / dt	dv / dt	V <sub>CE</sub> ≤320V, starting T <sub>ch</sub> =25°C	1500	V / μs
Allowable Power Dissipation	P <sub>D</sub>	When mounted on FR4 substrate (11,680mm <sup>2</sup> ×1.6mm)	1.2	W
Channel Temperature	T <sub>ch</sub>		150	°C
Storage Temperature	T <sub>stg</sub>		-40 to +150	°C

Stresses exceeding Maximum Ratings may damage the device. Maximum Ratings are stress ratings only. Functional operation above the Recommended Operating Conditions is not implied. Extended exposure to stresses above the Recommended Operating Conditions may affect device reliability.

### Package Dimensions

unit : mm (typ)

7072-002

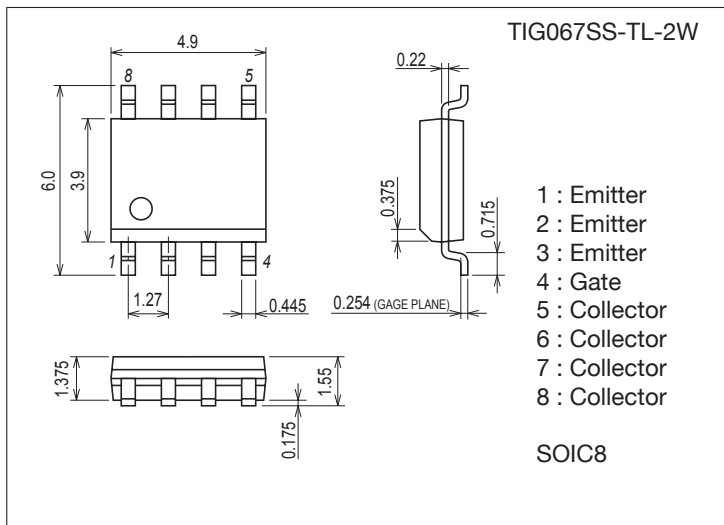

### Product & Package Information

- Package : SOIC8
- JEITA, JEDEC : SC-87, SOT-96
- Minimum Packing Quantity : 2500 pcs./reel

### Packing Type: TL

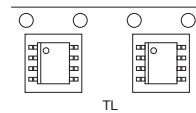

### Marking

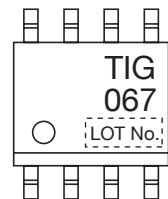

### Electrical Connection

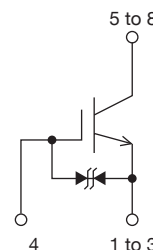

### ORDERING INFORMATION

See detailed ordering and shipping information on page 2 of this data sheet.

# TIG067SS

## Electrical Characteristics at Ta=25°C

Parameter	Symbol	Conditions	Ratings			Unit
			min	typ	max	
Collector-to-Emitter Breakdown Voltage	V(BR)CES	IC=2mA, VGE=0V	400			V
Collector-to-Emitter Cutoff Current	ICES	VCE=320V, VGE=0V			10	μA
Gate-to-Emitter Leakage Current	IGES	VGE=±6V, VCE=0V			±10	μA
Gate-to-Emitter Threshold Voltage	VGE(off)	VCE=10V, IC=1mA	0.4		1.0	V
Collector-to-Emitter Saturation Voltage	VCE(sat)	IC=150A, VGE=4V		3.8	5	V
Input Capacitance	Cies	VCE=10V, f=1MHz		5100		pF
Output Capacitance	Coes				59	pF
Reverse Transfer Capacitance	Cres				43	pF
Fall Time	tf	IC=150A, VCC=320V, Resistor load VGE=4V, RG=36Ω		270		ns

Product parametric performance is indicated in the Electrical Characteristics for the listed test conditions, unless otherwise noted. Product performance may not be indicated by the Electrical Characteristics if operated under different conditions.

**Fig1 Large Current R Load Switching Circuit**

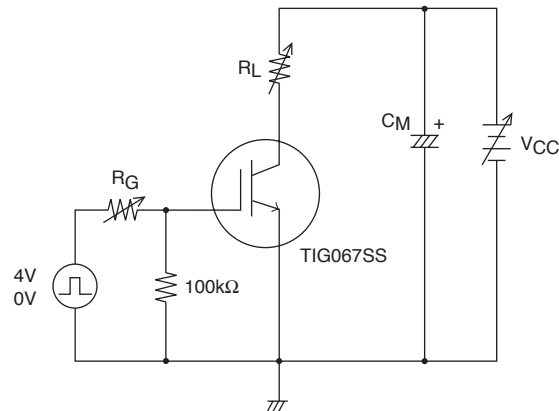

Note1. Gate Series Resistance  $R_G \geq 36\Omega$  is recommended for protection purpose at the time of turn OFF. However, if  $dv/dt \leq 1500/\mu s$  is satisfied at customer's actual set evaluation,  $R_G < 36\Omega$  can also be used.

Note2. The collector voltage gradient  $dv/dt$  must be smaller than  $1500V/\mu s$  to protect the device when it is turned off.

## ORDERING INFORMATION

Device	Package	Shipping	memo
TIG067SS-TL-2W	SOIC8	2,500pcs./reel	Pb-Free and Halogen Free

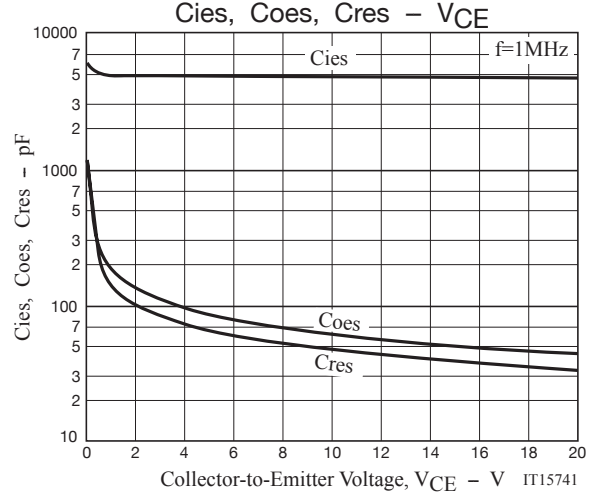
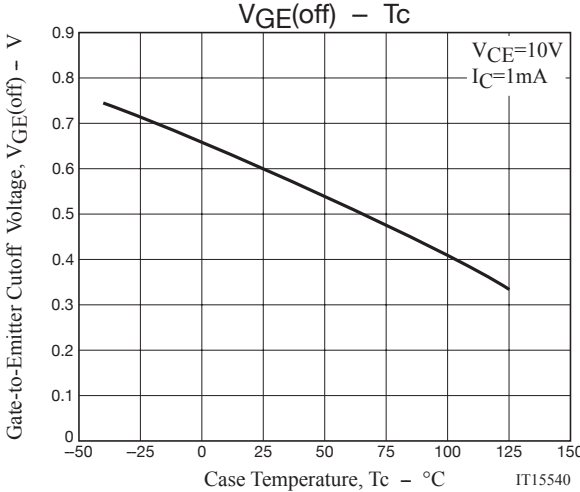
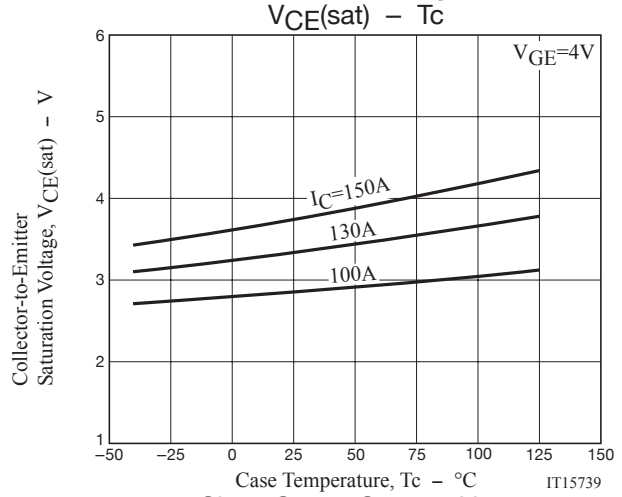
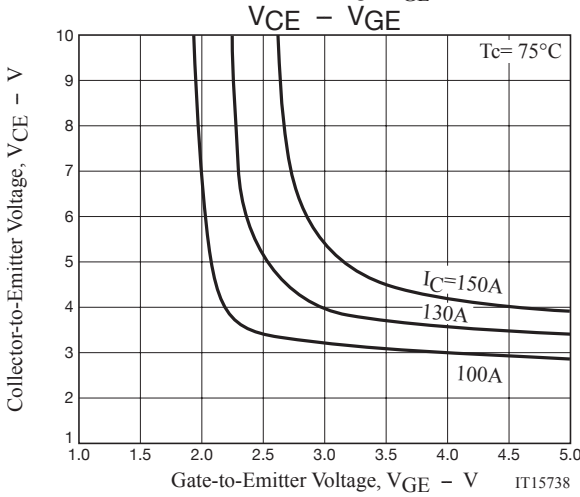
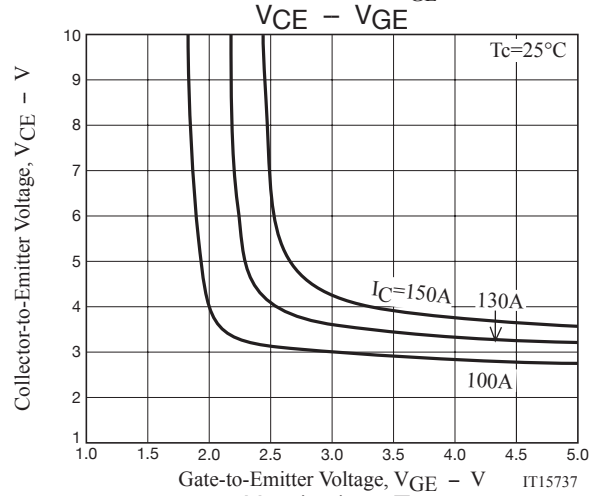
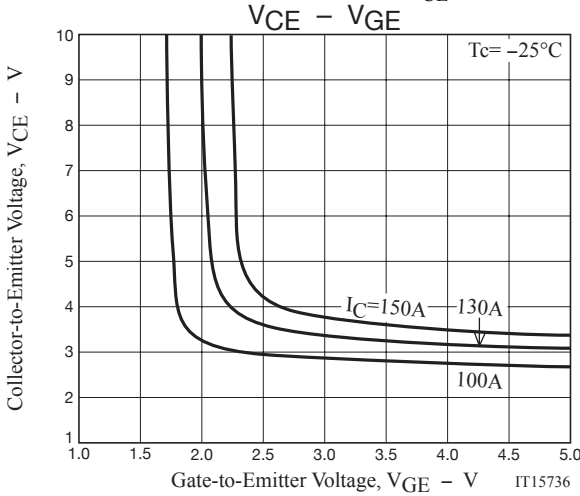
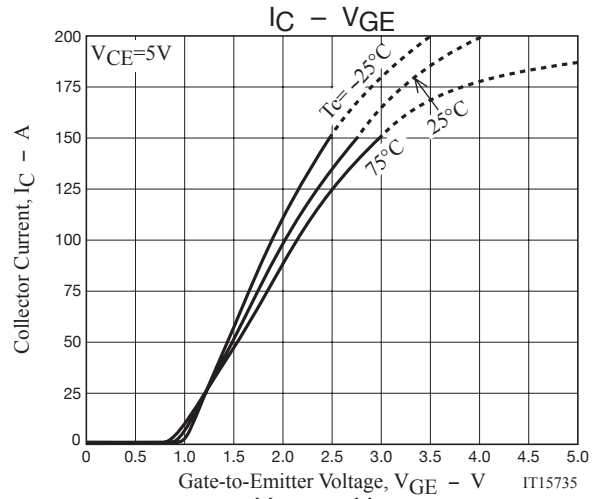
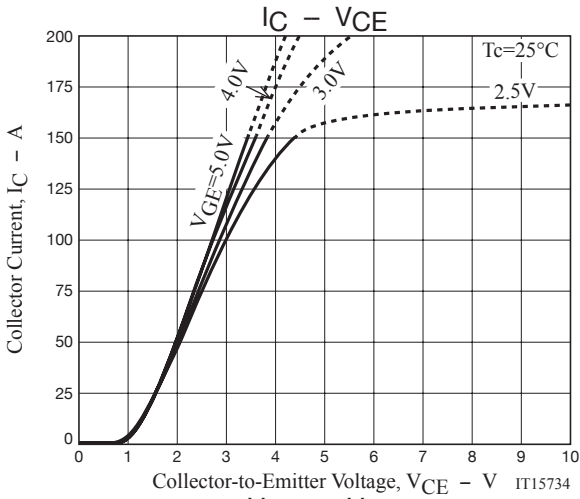

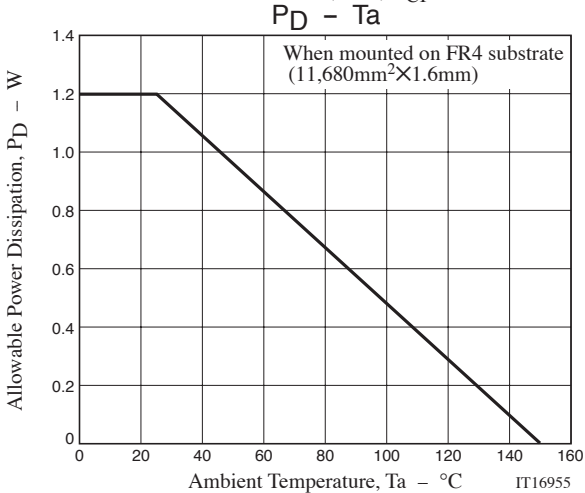
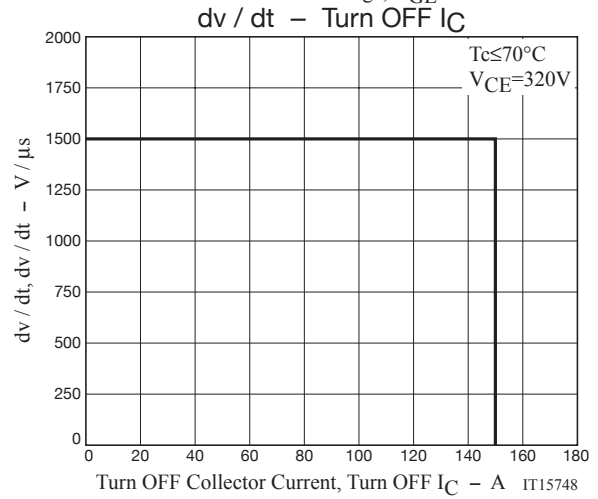
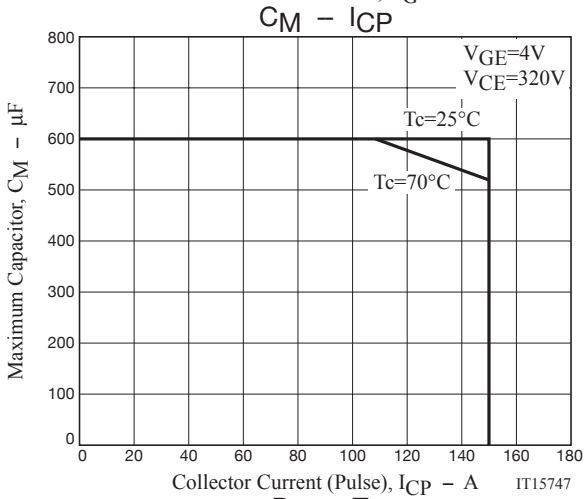
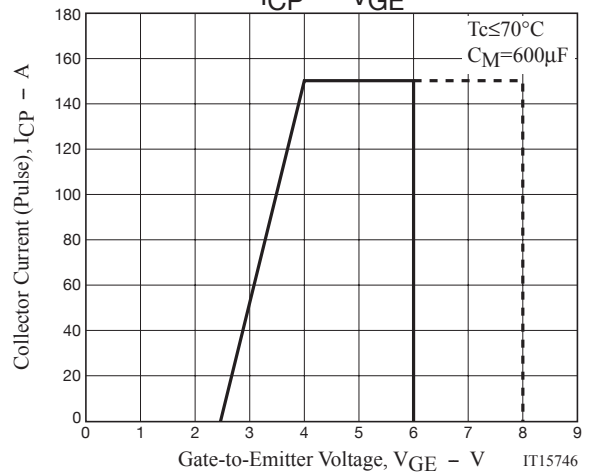
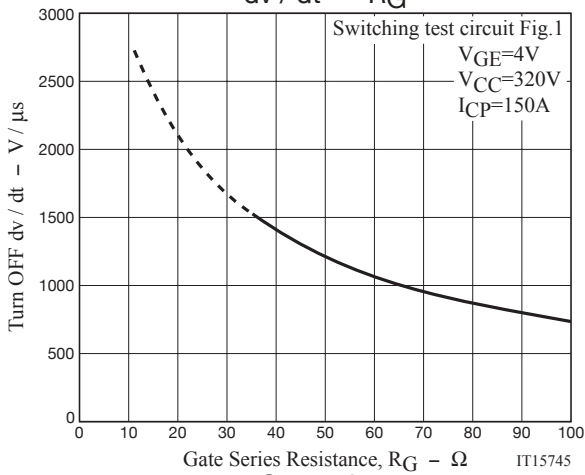
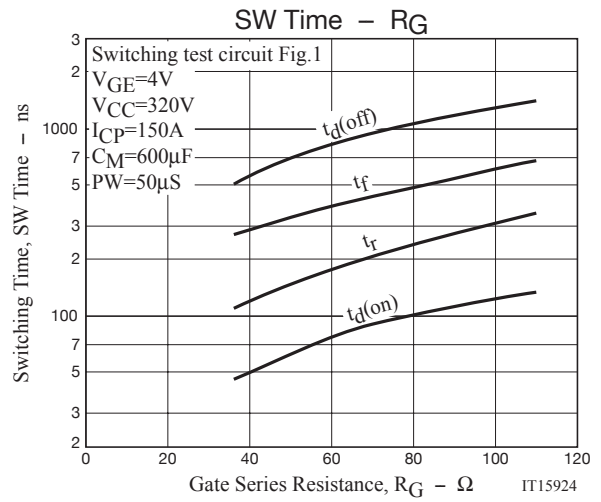
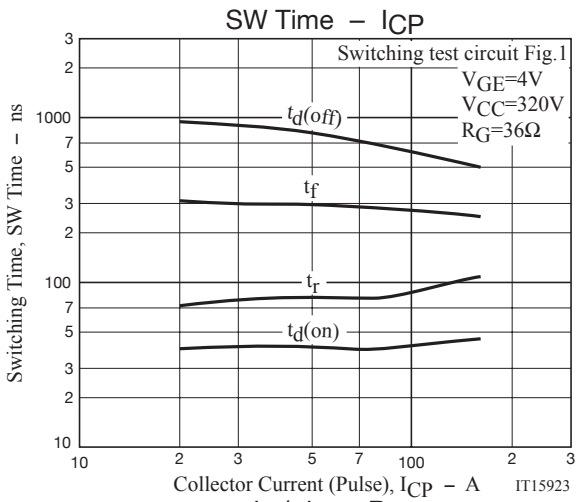

**Definition of dv/dt**

dv/dt is defined as the maximum slope of the below V<sub>CE</sub> curve during turn-off period.  
 $dv/dt = \Delta V_{CE} / \Delta t = \Delta V_{CE} / 100ns$

**Overall waveform**

**Enlarged picture of turn-off period**

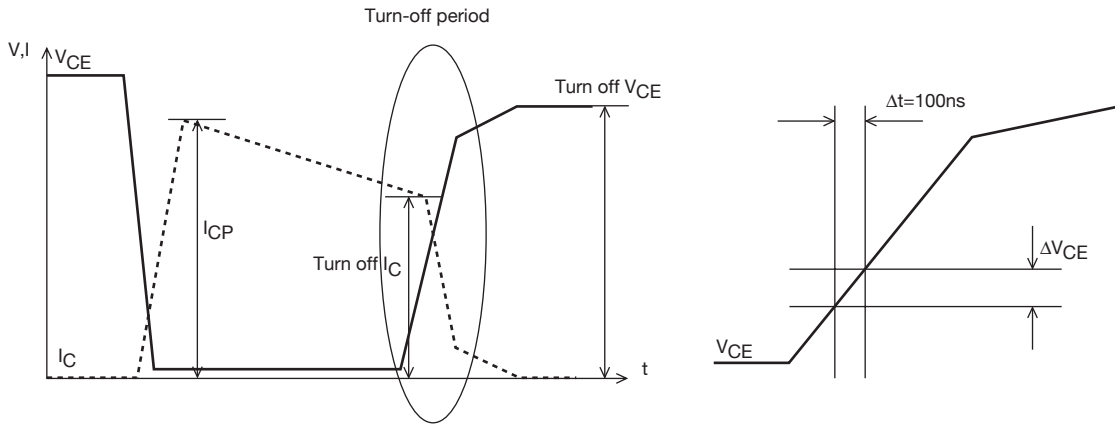

**Definition of Switching Time**

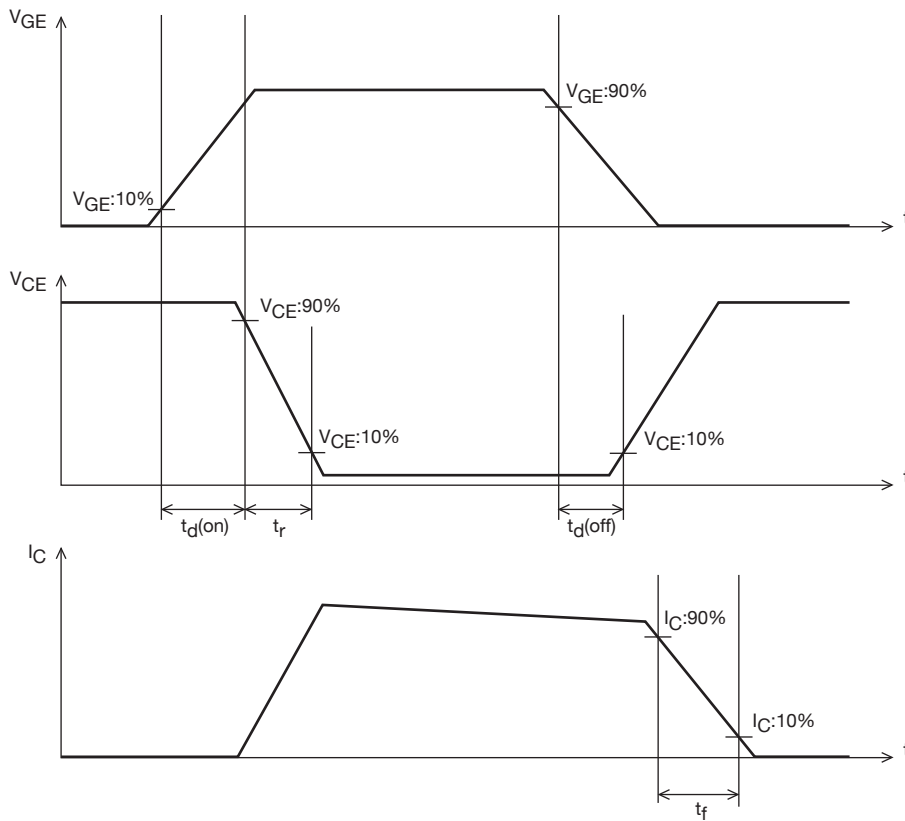

# TIG067SS

## Outline Drawing TIG067SS-TL-2W

## Land Pattern Example

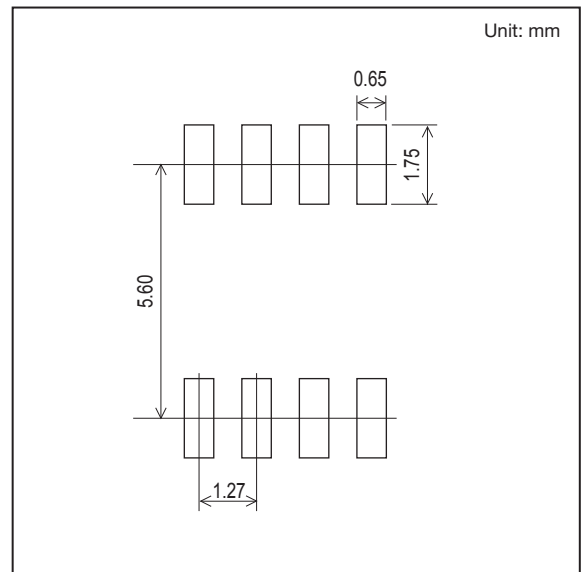
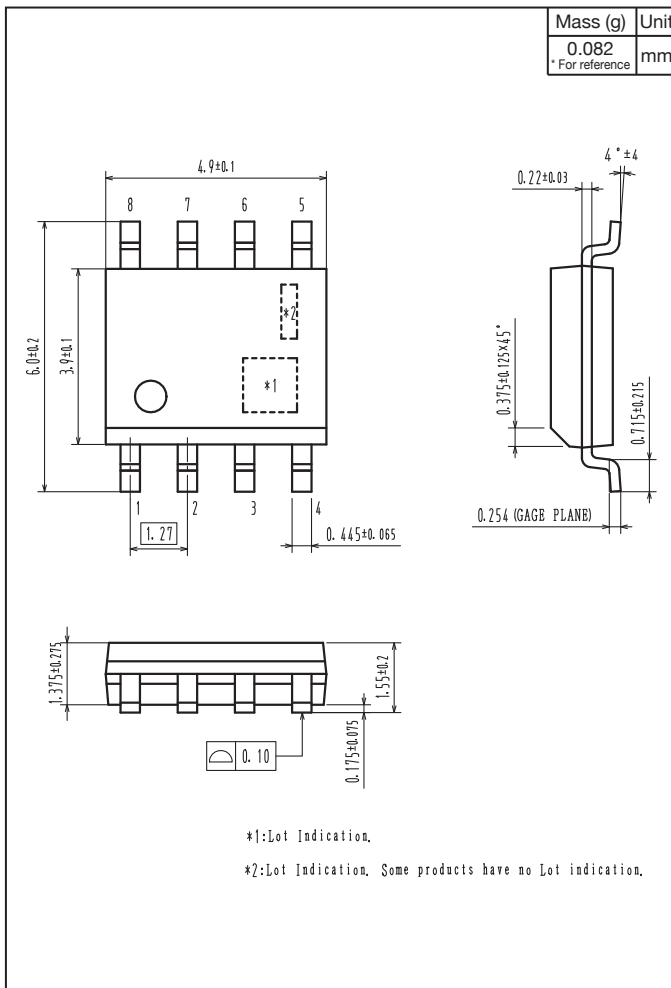

ON Semiconductor and the ON logo are registered trademarks of Semiconductor Components Industries, LLC (SCILLC) or its subsidiaries in the United States and/or other countries. SCILLC owns the rights to a number of patents, trademarks, copyrights, trade secrets, and other intellectual property. A listing of SCILLC's product/patent coverage may be accessed at [www.onsemi.com/site/pdf/Patent-Marking.pdf](http://www.onsemi.com/site/pdf/Patent-Marking.pdf). SCILLC reserves the right to make changes without further notice to any products herein. SCILLC makes no warranty, representation or guarantee regarding the suitability of its products for any particular purpose, nor does SCILLC assume any liability arising out of the application or use of any product or circuit, and specifically disclaims any and all liability, including without limitation special, consequential or incidental damages. "Typical" parameters which may be provided in SCILLC data sheets and/or specifications can and do vary in different applications and actual performance may vary over time. All operating parameters, including "Typicals" must be validated for each customer application by customer's technical experts. SCILLC does not convey any license under its patent rights nor the rights of others. SCILLC products are not designed, intended, or authorized for use as components in systems intended for surgical implant into the body, or other applications intended to support or sustain life, or for any other application in which the failure of the SCILLC product could create a situation where personal injury or death may occur. Should Buyer purchase or use SCILLC products for any such unintended or unauthorized application, Buyer shall indemnify and hold SCILLC and its officers, employees, subsidiaries, affiliates, and distributors harmless against all claims, costs, damages, and expenses, and reasonable attorney fees arising out of, directly or indirectly, any claim of personal injury or death associated with such unintended or unauthorized use, even if such claim alleges that SCILLC was negligent regarding the design or manufacture of the part. SCILLC is an Equal Opportunity/Affirmative Action Employer. This literature is subject to all applicable copyright laws and is not for resale in any manner.