



TO-220F Plastic-Encapsulate Transistors

TIP120F,121F,122F DARLINGTON TRANSISTOR (NPN)

TIP125F,126F,127F DARLINGTON TRANSISTOR (PNP)

FEATURES

- Medium Power Complementary Silicon Transistors

MAXIMUM RATINGS (T_a=25°C unless otherwise noted)

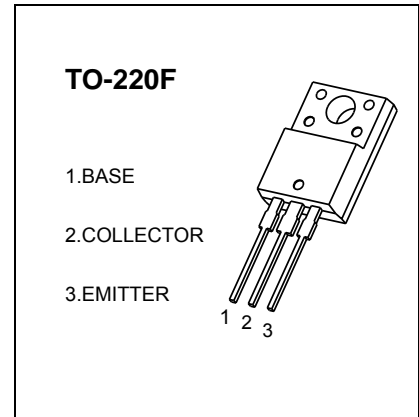

Symbol	Parameter	TIP120F TIP125F	TIP121F TIP126F	TIP122F TIP127F	Unit
V _{CBO}	Collector-Base Voltage	60	80	100	V
V _{CEO}	Collector-Emitter Voltage	60	80	100	V
V _{EBO}	Emitter-Base Voltage	5			V
I _C	Collector Current -Continuous	5			A
P _C	Collector Power Dissipation	2			W
R _{θJA}	Thermal Resistance, Junction to Ambient	62.5			°C/W
R _{θJC}	Thermal Resistance, Junction to Case	1.92			°C/W
T _J	Junction Temperature	150			°C
T _{stg}	Storage Temperature	-55~+150			°C

ELECTRICAL CHARACTERISTICS (T_a=25°C unless otherwise specified)

Parameter	Symbol	Test conditions	Min	Max	Unit
Collector-base breakdown voltage	TIP120F,TIP125F TIP121F,TIP126F TIP122F,TIP127F	V _{(BR)CBO}	I _C = 1mA, I _E =0	60 80 100	V
Collector-emitter breakdown voltage	TIP120F,TIP125F TIP121F,TIP126F TIP122F,TIP127F	V _{CEO(SUS)}	I _C = 30mA, I _B =0	60 80 100	V
Collector cut-off current	TIP120F,TIP125F TIP121F,TIP126F TIP122F,TIP127F	I _{CBO}	V _{CB} = 60 V, I _E =0 V _{CB} = 80 V, I _E =0 V _{CB} = 100V, I _E =0	0.2	mA
Collector cut-off current	TIP120F,TIP125F TIP121F,TIP126F TIP122F,TIP127F	I _{CEO}	V _{CE} =30 V, I _B =0 V _{CE} =40 V, I _B =0 V _{CE} =50 V, I _B =0	0.5	mA
Emitter cut-off current		I _{EBO}	V _{EB} =5 V, I _C =0	2	mA
DC current gain		h _{FE(1)}	V _{CE} = 3V, I _C =0.5A	1000	
		h _{FE(2)}	V _{CE} = 3V, I _C =3 A	1000	
Collector-emitter saturation voltage		V _{CE(sat)}	I _C =3A, I _B =12mA I _C =5 A, I _B =20mA	2 4	V
Base-emitter voltage		V _{BE}	V _{CE} =3V, I _C =3 A	2.5	V
Output Capacitance	TIP125F,TIP126F,TIP127F TIP120F,TIP121F,TIP122F	C _{ob}	V _{CB} =10V, I _E =0, f=0.1MHz	300 200	pF

Typical Characteristics

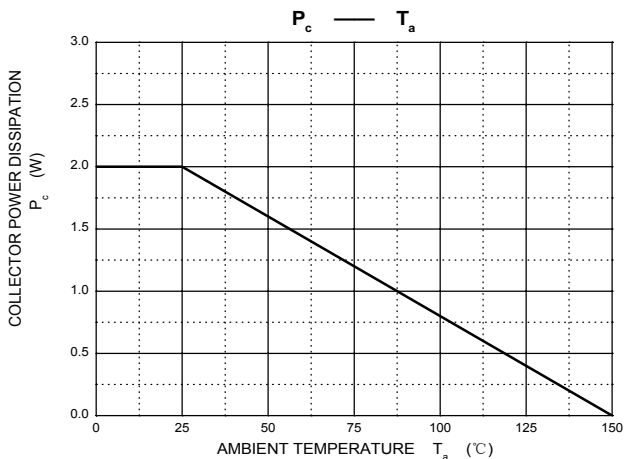
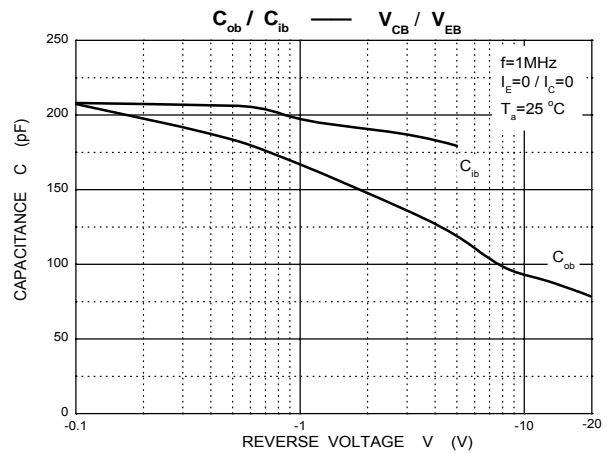
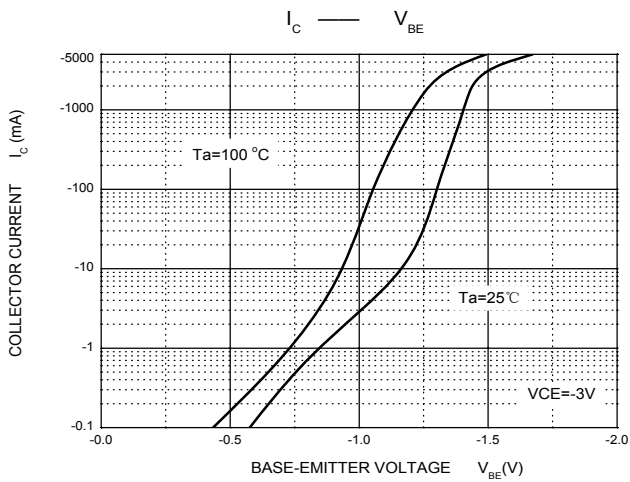
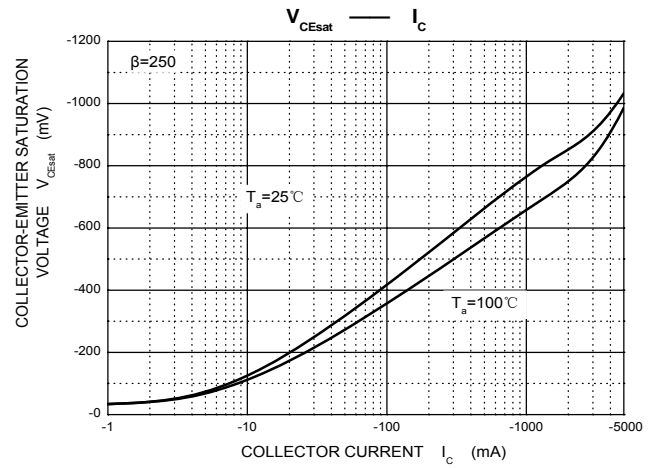
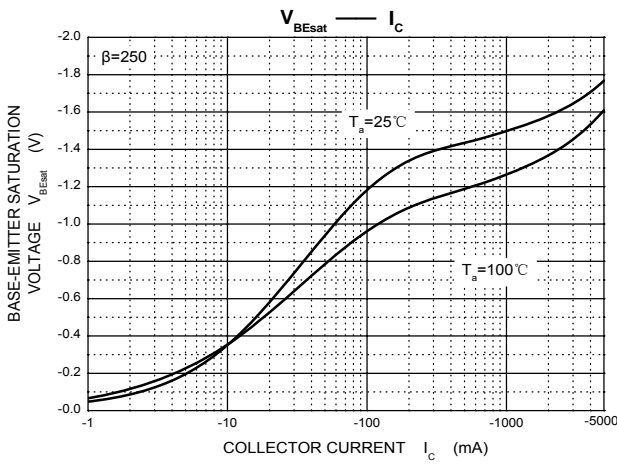
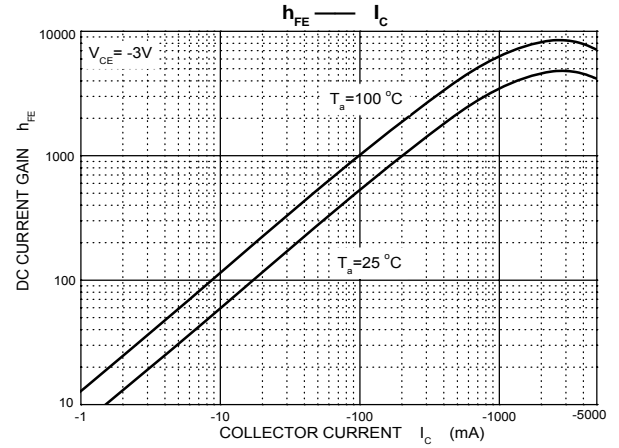
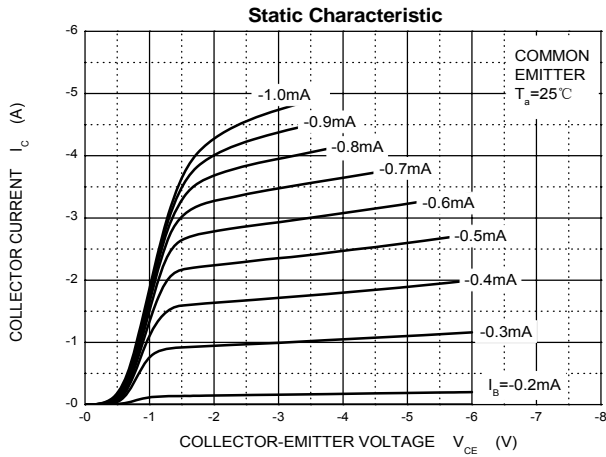

TO-220F Package Outline Dimensions

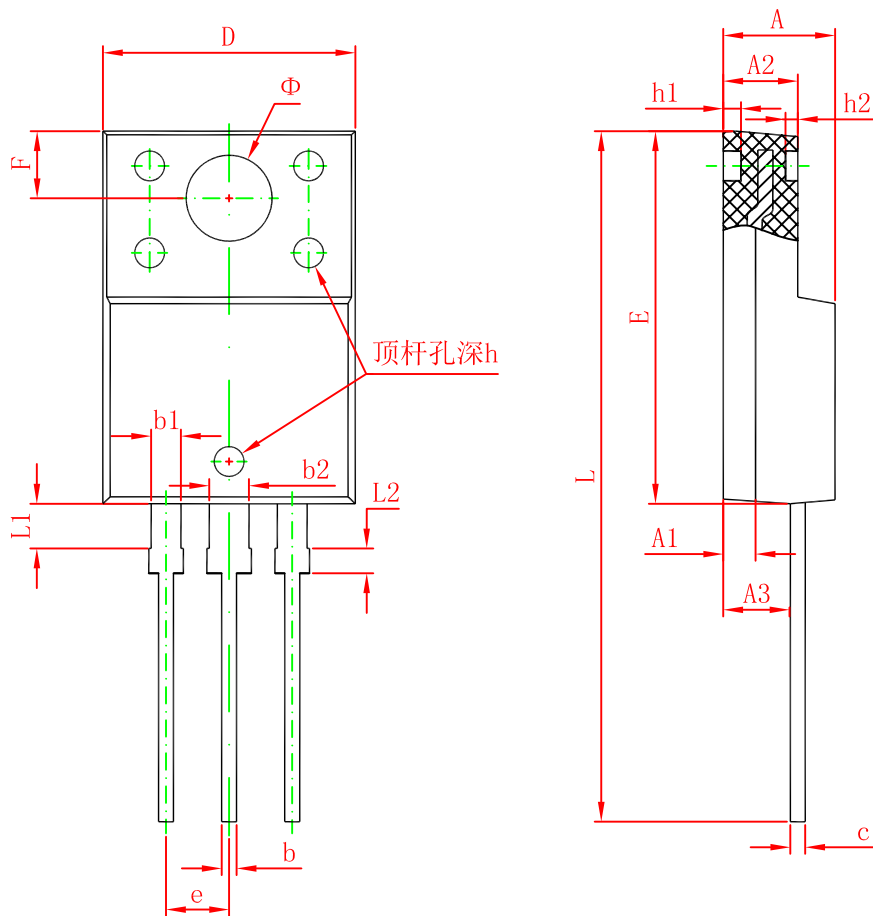

Symbol	Dimensions In Millimeters		Dimensions In Inches	
	Min.	Max.	Min.	Max.
A	4.300	4.700	0.169	0.185
A1	1.300 REF.		0.051 REF.	
A2	2.800	3.200	0.110	0.126
A3	2.500	2.900	0.098	0.114
b	0.500	0.750	0.020	0.030
b1	1.100	1.350	0.043	0.053
b2	1.500	1.750	0.059	0.069
c	0.500	0.750	0.020	0.030
D	9.960	10.360	0.392	0.408
E	14.800	15.200	0.583	0.598
e	2.540 TYP.		0.100 TYP.	
F	2.700 REF.		0.106 REF.	
Φ	3.500 REF.		0.138 REF.	
h	0.000	0.300	0.000	0.012
h1	0.800 REF.		0.031 REF.	
h2	0.500 REF.		0.020 REF.	
L	28.000	28.400	1.102	1.118
L1	1.700	1.900	0.067	0.075
L2	0.900	1.100	0.035	0.043