

TIP125/126/127

Monolithic Construction With Built In Base-Emitter Shunt Resistors

- High DC Current Gain : $h_{FE}=1000$ @ $V_{CE}=-4V, I_C=-3A$ (Min.)
- Collector-Emitter Sustaining Voltage
- Low Collector-Emitter Saturation Voltage
- Industrial Use
- Complementary to TIP120/121/122

Absolute Maximum Ratings $T_a=25^\circ\text{C}$ unless otherwise noted

CHARACTERISTICS	SYMBOL	RATING	UNIT
Collector-Base Voltage : TIP125 : TIP126 : TIP127	V_{CBO}	-60 -80 -100	V V V
Collector-Emitter Voltage : TIP125 : TIP126 : TIP127	V_{CEO}	-60 -80 -100	V V V
Emitter-Base Voltage	V_{EBO}	-5	V
Collector Current(DC)	I_C	-5	A
Collector Current(Pulse)	I_{CP}	-8	A
Base Current	I_B	-120	mA
Collector Dissipation($T_a=25^\circ\text{C}$)	P_C	2	W
Collector Dissipation($T_c=25^\circ\text{C}$)	P_C	65	W
Junction Temperature	T_J	150	$^\circ\text{C}$
Storage Temperature	T_{STG}	-65~150	$^\circ\text{C}$

PNP Epitaxial Silicon Darlington Transistor

Equivalent Circuit

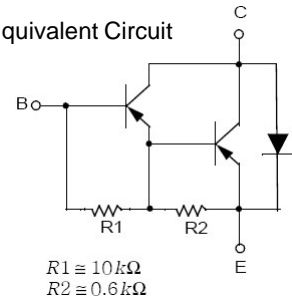

TO-220

1. Base
2. Collector
3. Emitter



Electrical Characteristics $T_a=25^\circ\text{C}$ unless otherwise noted

CHARACTERISTICS	SYMBOL	Test Condition	Min	Max	Unit
Collector-Emitter Sustaining Voltage : TIP125 : TIP126 : TIP127	$V_{CEO(SUS)}$	$I_C=-100\text{mA}, I_B=0$	-60 -80 -100		V V V
Collector Cut-off Current : TIP125 : TIP126 : TIP127	I_{CEO}	$V_{CE}=-30V, I_B=0$ $V_{CE}=-40V, I_B=0$ $V_{CE}=-50V, I_B=0$		-2 -2 -2	mA mA mA
Collector Cut-off Current : TIP125 : TIP126 : TIP127	I_{CBO}	$V_{CE}=-60V, I_E=0$ $V_{CE}=-80V, I_E=0$ $V_{CE}=-100V, I_E=0$		-1 -1 -1	mA mA mA
Emitter Cut-off Current	I_{EBO}	$V_{EB}=-5V, I_C=0$		-2	mA
DC Current Gain	h_{FE}	$V_{CE}=-3V, I_C=-0.5A$ $V_{CE}=-3V, I_C=-3A$	1000 1000		
Collector-Emitter Saturation Voltage	$V_{CE(sat)}$	$I_C=-3A, I_B=-12\text{mA}$ $I_C=-5A, I_B=-20\text{mA}$		-2 -4	V V
Base-Emitter ON Voltage	$V_{BE(on)}$	$V_{CE}=-3V, I_C=-3A$		-2.5	V
Output Capacitance	C_{ob}	$V_{CB}=-10V, I_E=0, f=0.1\text{MHz}$		300	pF

* Pulse Test: $PW \leq 300\mu\text{s}$, Duty Cycle $\leq 2\%$

Typical Characteristics

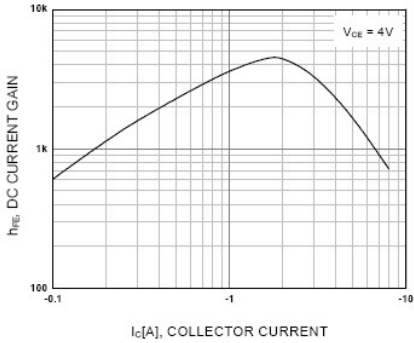

Figure 1. DC current Gain

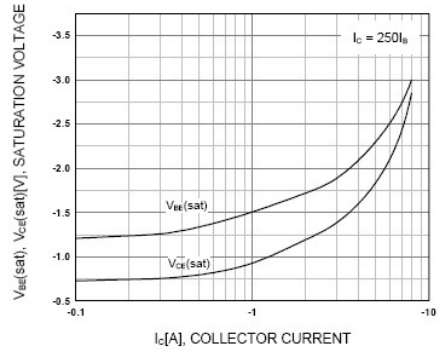

Figure 2. Base-Emitter Saturation Voltage
Collector-Emitter Saturation Voltage

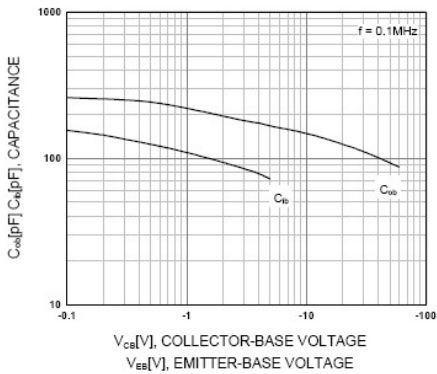

Figure 3. Output and Input Capacitance vs. Reverse Voltage

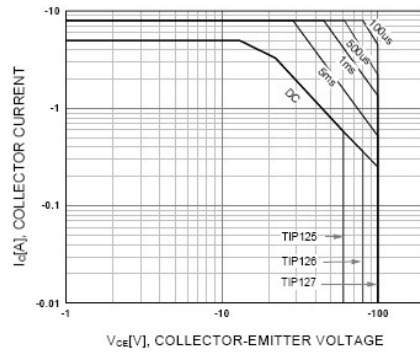

Figure 4. Safe Operating Area

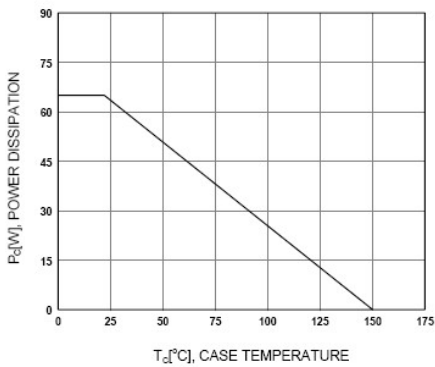
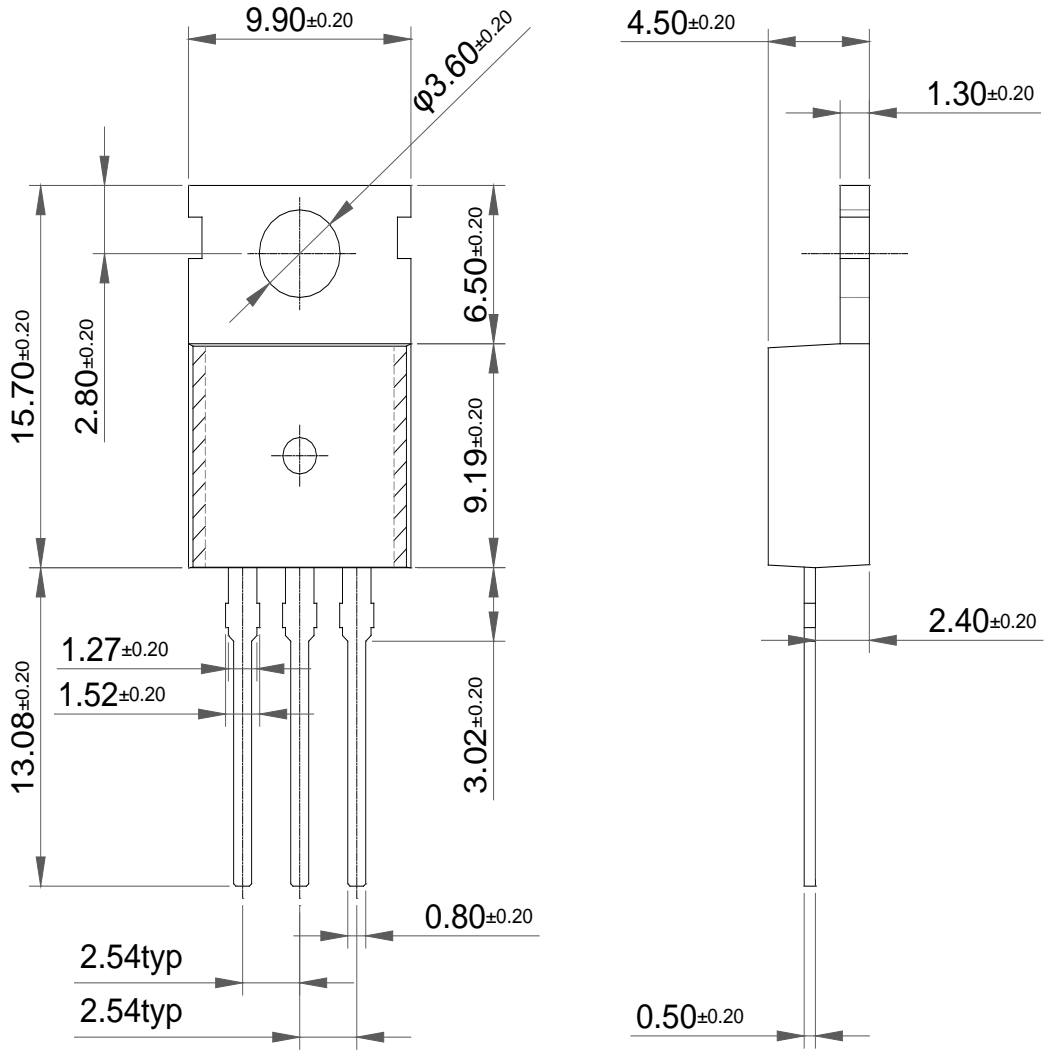

Figure 5. Power Derating

Package Dimension

TO-220 (A)



Dimensions in Millimeters

Package Dimension

TO-220 (B)

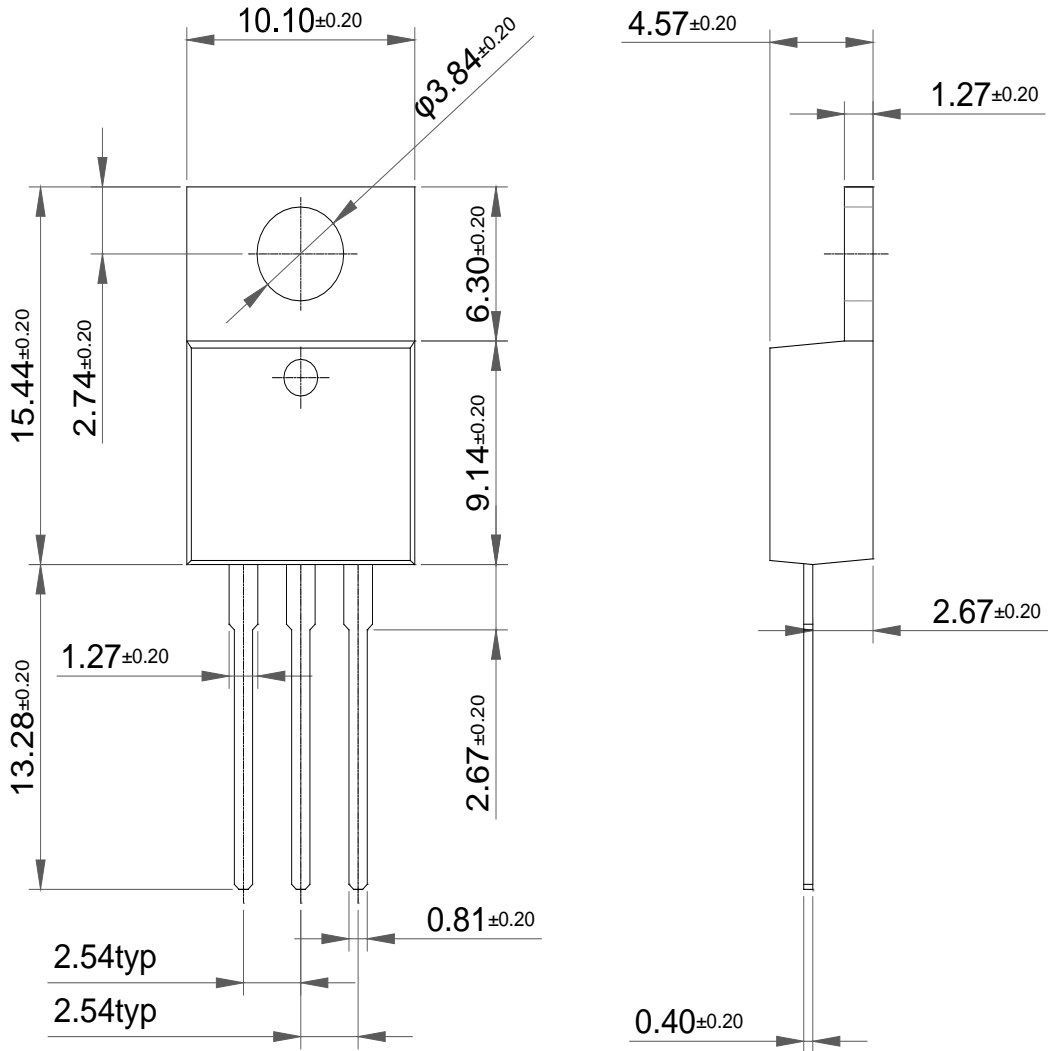

Dimensions in Millimeters