

描述 / Descriptions

TO-220 塑封封装 PNP 半导体三极管。Silicon PNP transistor in a TO-220 Plastic Package.

特征 / Features

基极-发射极设有独立的电阻、直流增益高、与 TIP142T 配对。

Monolithic construction with built in base-emitter shunt resistors, High DC current gain complement to TIP142T.

用途 / Applications

用于工业仪器的线性开关转换。

Linear and switching industrial equipment.

内部等效电路 / Equivalent Circuit

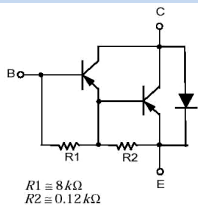

引脚排列 / Pinning

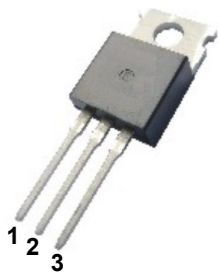

PIN 1 : Base PIN 2 : Collector PIN 3 : Emitter

放大及印章代码 / h_{FE} Classifications & Marking

见印章说明。See Marking Instructions.

极限参数 / Absolute Maximum Ratings(Ta=25°C)

| 参数 Parameter | 符号 Symbol | 数值 Rating | 单位 Unit |
|--------------------------------|-----------------------------|--------------|------------|
| Collector to Base Voltage | V_{CBO} | -100 | V |
| Collector to Emitter Voltage | V_{CEO} | -100 | V |
| Emitter to Base Voltage | V_{EBO} | -5.0 | V |
| Collector Current - Continuous | I_C | -10 | A |
| Peak Collector Current | I_{CP} | -15 | A |
| Base Current - Continuous | I_B | -0.5 | A |
| Collector Power Dissipation | $P_C(T_C=25^\circ\text{C})$ | 80 | W |
| Junction Temperature | T_j | 150 | °C |
| Storage Temperature Range | T_{stg} | -55~150 | °C |

电性能参数 / Electrical Characteristics(Ta=25°C)

| 参数 Parameter | 符号 Symbol | 测试条件 Test Conditions | 最小值 Min | 典型值 Typ | 最大值 Max | 单位 Unit |
|---|------------------|---|------------|------------|------------|------------|
| Collector to Emitter Breakdown Voltage | V_{CEO} | $I_C=-30\text{mA}$ $I_B=0$ | -100 | | | V |
| Collector Cut-Off Current | I_{CEO} | $V_{CE}=-50\text{V}$ $I_B=0$ | | | -2.0 | mA |
| Collector Cut-Off Current | I_{CBO} | $V_{CB}=-100\text{V}$ $I_E=0$ | | | -1.0 | mA |
| Emitter Cut-Off Current | I_{EBO} | $V_{EB}=-5.0\text{V}$ $I_C=0$ | | | -2.0 | mA |
| DC Current Gain | $h_{FE(1)}$ | $V_{CE}=-4.0\text{V}$ $I_C=-5.0\text{A}$ | 1000 | | | |
| | $h_{FE(2)}$ | $V_{CE}=-4.0\text{V}$ $I_C=-10\text{A}$ | 500 | | | |
| Collector to Emitter Saturation Voltage | $V_{CE(sat)(1)}$ | $I_C=-5.0\text{A}$ $I_B=-10\text{mA}$ | | | -2.0 | V |
| | $V_{CE(sat)(2)}$ | $I_C=-10\text{A}$ $I_B=-40\text{mA}$ | | | -3.0 | V |
| Base to Emitter Saturation Voltage | $V_{BE(sat)}$ | $I_C=-10\text{A}$ $I_B=-40\text{mA}$ | | | -3.5 | V |
| Base to Emitter Voltage | V_{BE} | $V_{CE}=-4.0\text{V}$ $I_C=-10\text{A}$ | | | -3.0 | V |
| Delay Time | t_D | $V_{CC}=-3\text{V}$ $I_C=-5\text{A}$ $I_{B1}=-20\text{mA}$ $I_{B2}=20\text{mA}$ $R_L=6\Omega$ | | 0.15 | | μs |
| Rise Time | t_R | | | 0.55 | | μs |
| Storage Time | t_{STG} | | | 2.5 | | μs |
| Fall Time | t_F | | | 2.5 | | μs |

电参数曲线图 / Electrical Characteristic Curve

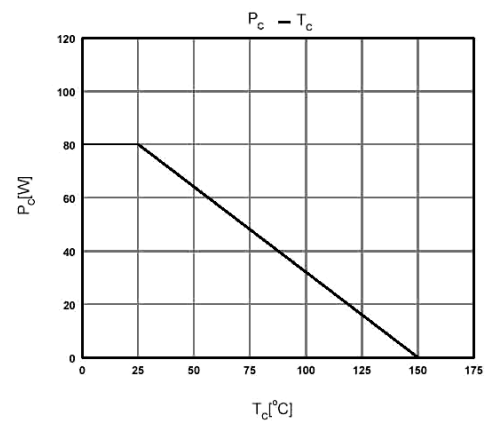
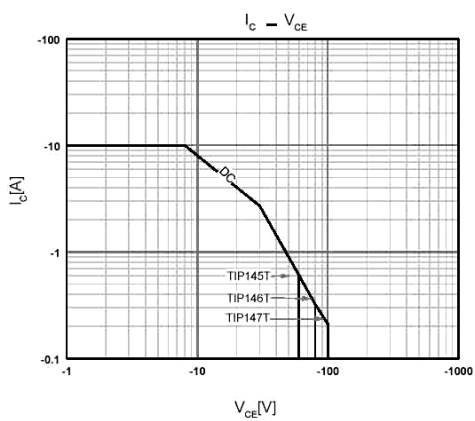
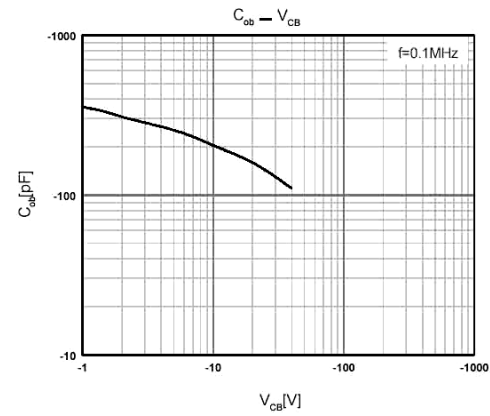
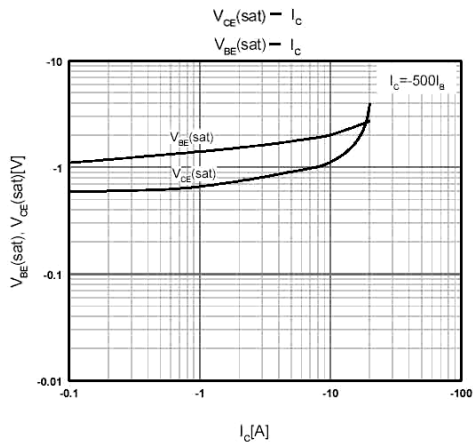
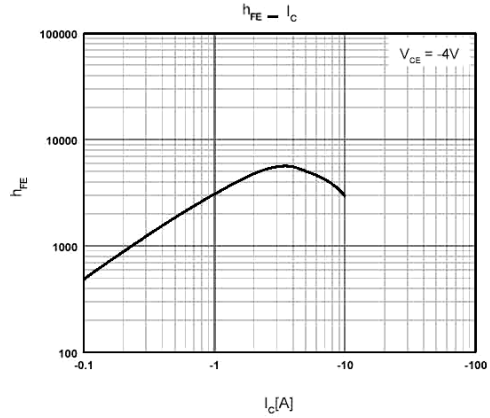
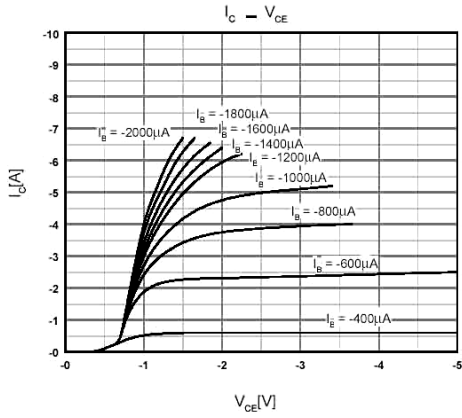

外形尺寸图 / Package Dimensions

T0-220

单位: mm

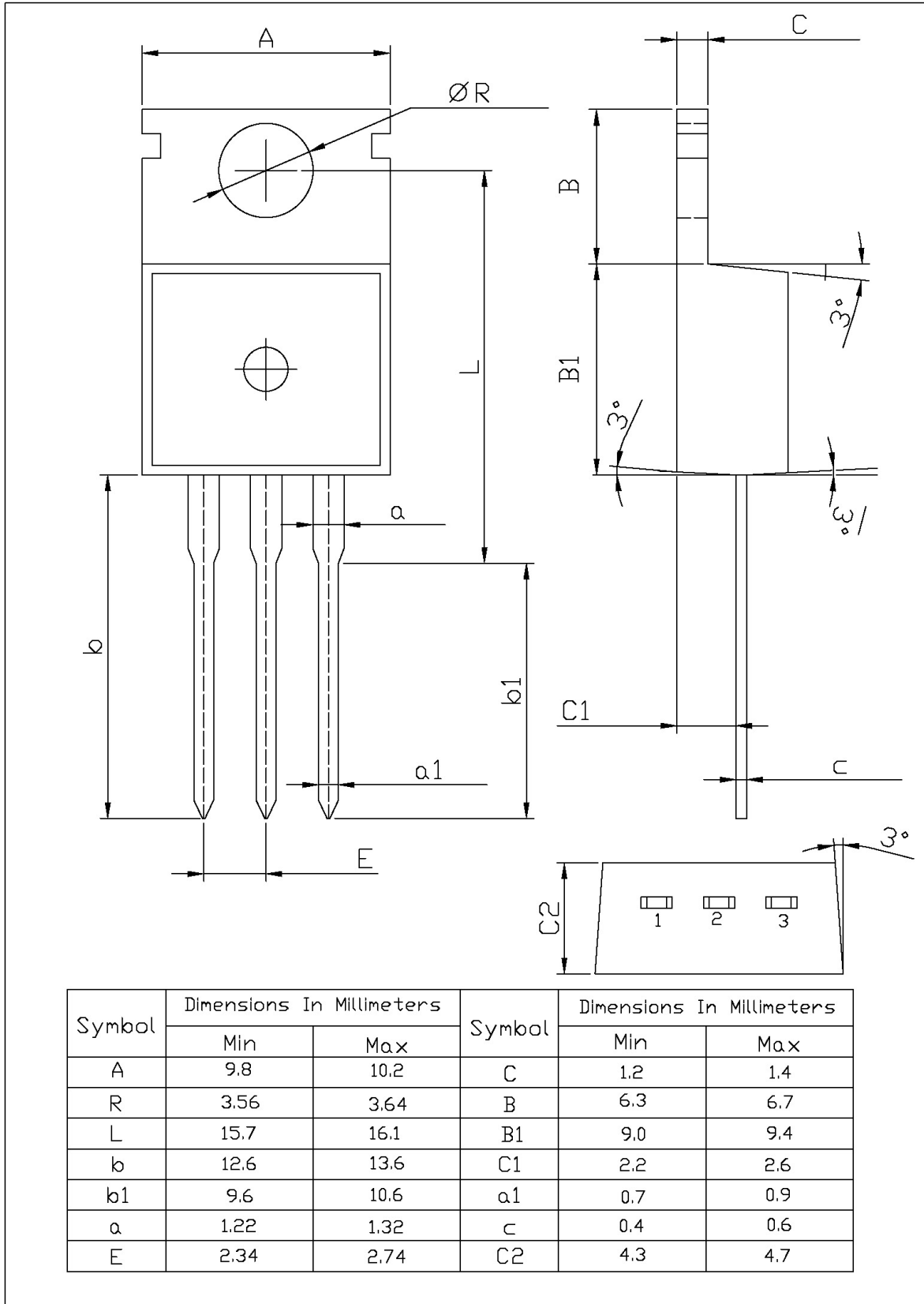

印章说明 / Marking Instructions

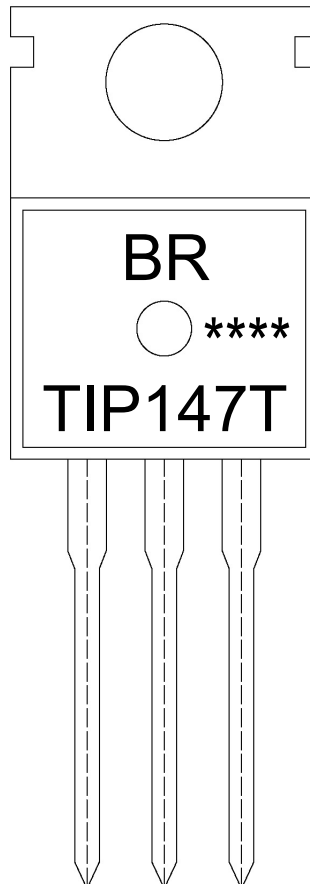

说明：

BR： 为公司代码

TIP147T： 为产品型号

****： 为生产批号代码，随生产批号变化。

Note:

BR: Company Code

TIP147T: Product Type.

****: Lot No. Code, code change with Lot No.

波峰焊温度曲线图(无铅) / Temperature Profile for Dip Soldering(Pb-Free)



说明：

- 1、预热温度 25 ~ 150°C，时间 60 ~ 90sec;
- 2、峰值温度 255±5°C，时间持续为 5±0.5sec;
- 3、焊接制程冷却速度为 2 ~ 10°C/sec.

Note:

- 1.Preheating:25~150°C, Time:60~90sec.
- 2.Peak Temp.:255±5°C, Duration:5±0.5sec.
3. Cooling Speed: 2~10°C/sec.

耐焊接热试验条件 / Resistance to Soldering Heat Test Conditions

温度：270±5°C 时间：10±1 sec. Temp.:270±5°C Time:10±1 sec

包装规格 / Packaging SPEC.

散件包装 / BULK

| Package Type 封装形式 | Units 包装数量 | | | | | Dimension 包装尺寸 (unit: mm ³) | | |
|----------------------|------------------|-----------------------|------------------------|------------------------------|------------------------|---|-------------|-------------|
| | Units/Bag 只/袋 | Bags/Inner Box 袋/盒 | Units/Inner Box 只/盒 | Inner Boxes/Outer Box 盒/箱 | Units/Outer Box 只/箱 | Bag 袋 | Inner Box 盒 | Outer Box 箱 |
| TO-220/F | 200 | 10 | 2,000 | 5 | 10,000 | 135×190 | 237×172×102 | 560×245×195 |

套管包装 / TUBE

| Package Type 封装形式 | Units 包装数量 | | | | | Dimension 包装尺寸 (unit: mm ³) | | |
|----------------------|--------------------|-------------------------|------------------------|------------------------------|------------------------|---|-------------|-------------|
| | Units/Tube 只/套管 | Tubes/Inner Box 套管/盒 | Units/Inner Box 只/盒 | Inner Boxes/Outer Box 盒/箱 | Units/Outer Box 只/箱 | Tube 套管 | Inner Box 盒 | Outer Box 箱 |
| TO-220/F | 50 | 20 | 1,000 | 5 | 5,000 | 532×31.4×5.5 | 555×164×50 | 575×290×180 |

使用说明 / Notices