

# TIP31/31A/31B/31C

**SemiHow**  
Know-How for Semiconductor

# TIP31/31A/31B/31C

## Medium Power Linear Switching Applications

- Complement to TIP32/32A/32B/32C

### Absolute Maximum Ratings $T_a=25^\circ\text{C}$ unless otherwise noted

CHARACTERISTICS	SYMBOL	RATING	UNIT
Collector-Base Voltage : TIP31	$V_{CBO}$	40	V
: TIP31A		60	V
: TIP31B		80	V
: TIP31C		100	V
Collector-Emitter Voltage : TIP31	$V_{CEO}$	40	V
: TIP31A		60	V
: TIP31B		80	V
: TIP31C		100	V
Emitter-Base Voltage	$V_{EBO}$	5	V
Collector Current(DC)	$I_C$	3	A
Collector Current(Pulse)	$I_{CP}$	5	A
Base Current	$I_B$	1	A
Collector Dissipation( $T_a=25^\circ\text{C}$ )	$P_C$	2	W
Collector Dissipation( $T_c=25^\circ\text{C}$ )	$P_C$	40	W
Junction Temperature	$T_J$	150	$^\circ\text{C}$
Storage Temperature	$T_{STG}$	-65~150	$^\circ\text{C}$

### PNP Epitaxial Silicon Darlington Transistor

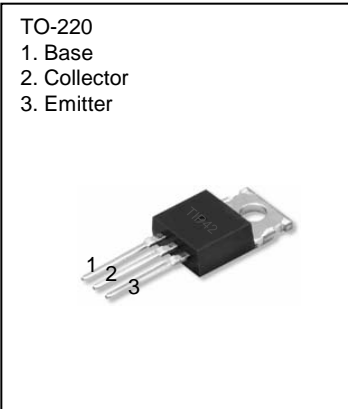

- TO-220  
1. Base  
2. Collector  
3. Emitter

### Electrical Characteristics $T_a=25^\circ\text{C}$ unless otherwise noted

CHARACTERISTICS	SYMBOL	Test Condition	Min	Max	Unit		
Collector-Emitter Sustaining Voltage : TIP31 : TIP31A : TIP31B : TIP31C	$V_{CEO(SUS)}$	$I_C=30\text{mA}, I_B=0$	40		V		
			60		V		
			80		V		
			100		V		
Collector Cut-off Current : TIP31/31A : TIP31B/31C	$I_{CEO}$	$V_{CE}=30\text{V}, I_B=0$		0.3	mA		
		$V_{CE}=60\text{V}, I_B=0$		0.3	mA		
Collector Cut-off Current : TIP31 : TIP31A : TIP31B : TIP31C	$I_{CES}$	$V_{CE}=40\text{V}, V_{EB}=0$ $V_{CE}=60\text{V}, V_{EB}=0$ $V_{CE}=80\text{V}, V_{EB}=0$ $V_{CE}=100\text{V}, V_{EB}=0$		200	$\mu\text{A}$		
					200	$\mu\text{A}$	
						200	$\mu\text{A}$
						200	$\mu\text{A}$
Emitter Cut-off Current	$I_{EBO}$	$V_{EB}=5\text{V}, I_C=0$		1	mA		
*DC Current Gain	$h_{FE}$	$V_{CE}=4\text{V}, I_C=1\text{A}$	25				
		$V_{CE}=4\text{V}, I_C=3\text{A}$	10	50			
*Collector-Emitter Saturation Voltage	$V_{CE(sat)}$	$I_C=3\text{A}, I_B=375\text{mA}$		1.2	V		
*Base-Emitter ON Voltage	$V_{BE(on)}$	$V_{CE}=4\text{V}, I_C=3\text{A}$		1.8	V		
Output Capacitance	$f_T$	$V_{CE}=10\text{V}, I_C=500\text{mA}, f=1\text{MHz}$	3.0		MHz		

\* Pulse Test:  $PW \leq 300\mu\text{s}$ , Duty Cycle  $\leq 2\%$

# Typical Characteristics

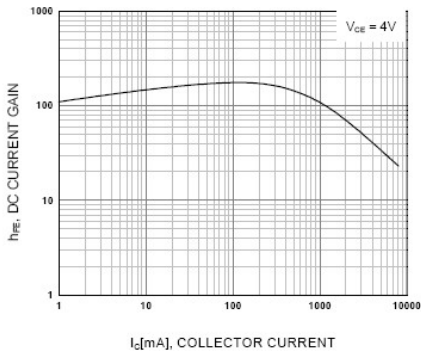

Figure 1. DC current Gain

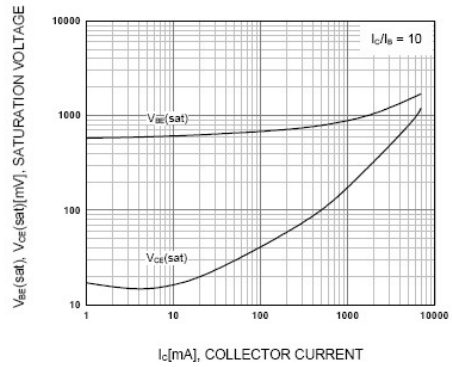

Figure 2. Base-Emitter Saturation Voltage  
Collector-Emitter Saturation Voltage

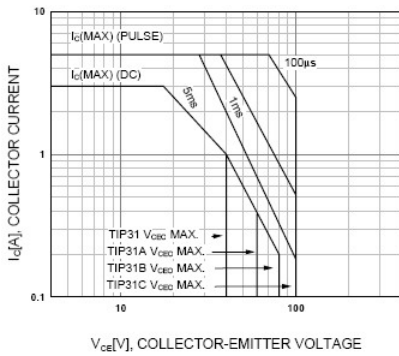

Figure 3. Safe Operating Area

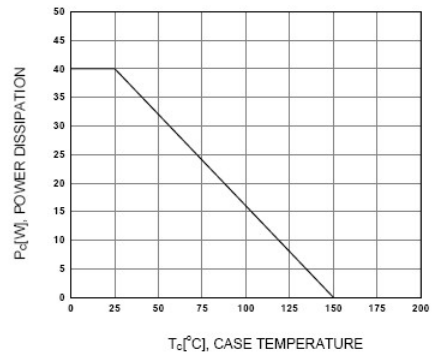
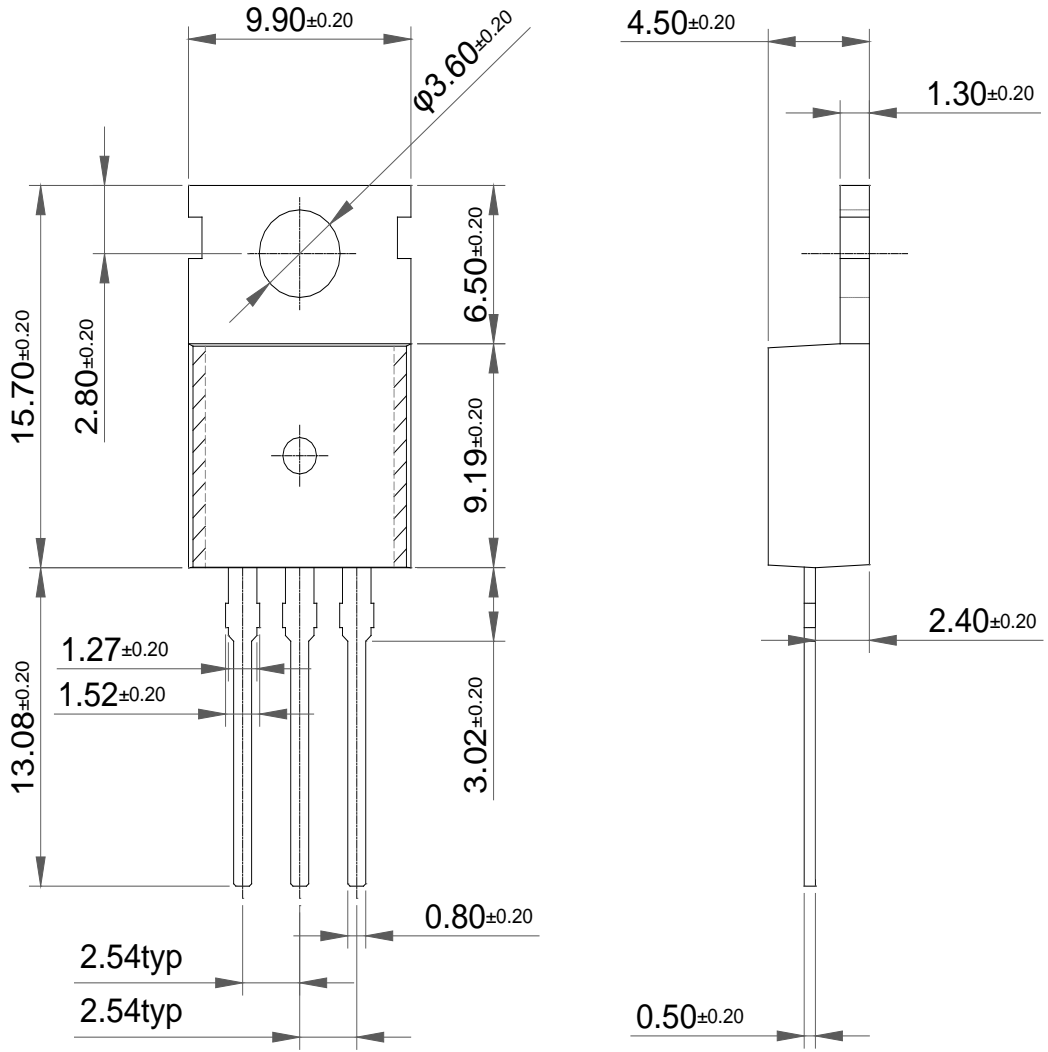

Figure 4. Power Derating

Package Dimension

# TO-220 (A)



Dimensions in Millimeters

Package Dimension

# TO-220 (B)

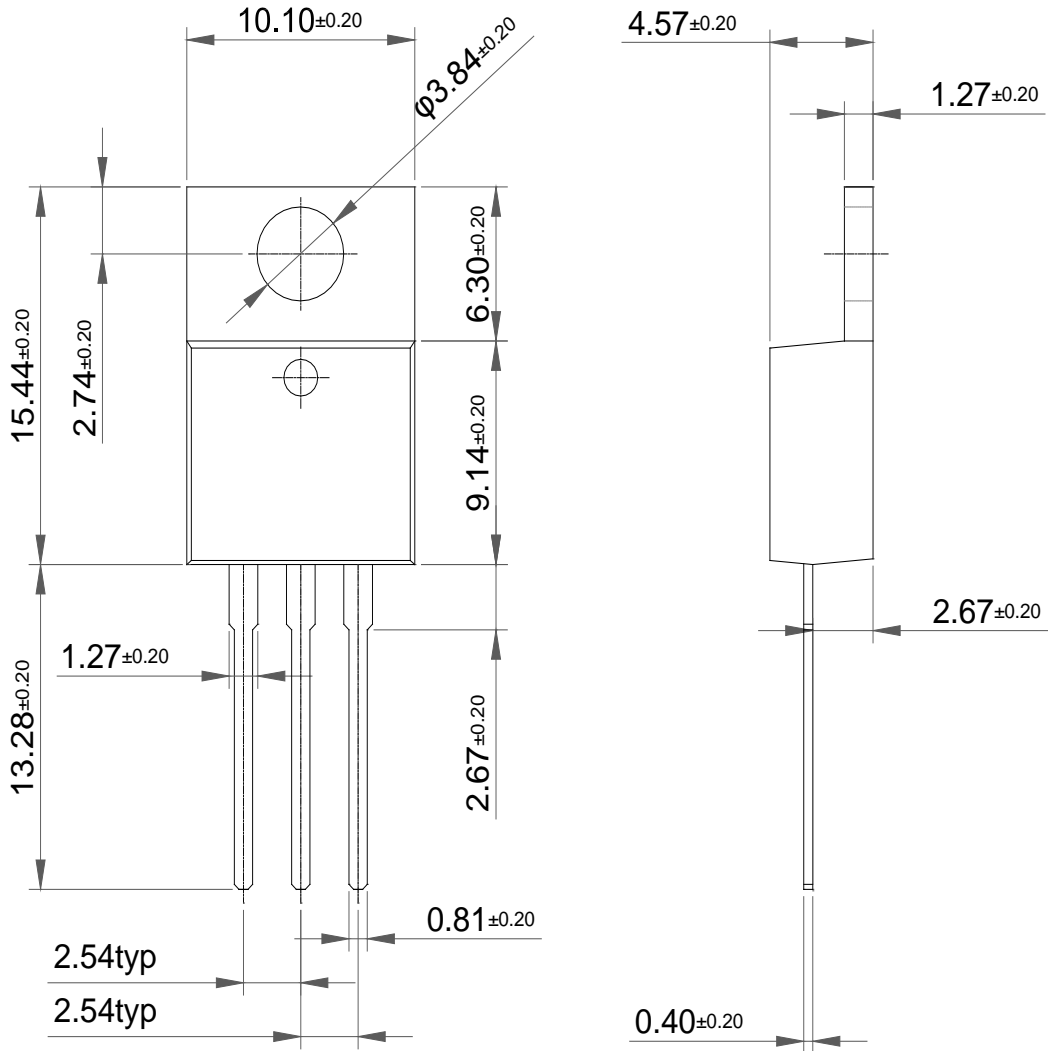

Dimensions in Millimeters