



# TIP41CN TIP42CN

## COMPLEMENTARY SILICON POWER TRANSISTORS

PRELIMINARY DATA

- n COMPLEMENTARY PNP-NPN DEVICES
- n NEW ENHANCED SERIES
- n HIGH SWITCHING SPEED
- n  $h_{FE}$  GROUPING
- n  $h_{FE}$  IMPROVED LINEARITY

### APPLICATION

- n GENERAL PURPOSE CIRCUITS
- n AUDIO AMPLIFIER
- n POWER LINEAR AND SWITCHING

### DESCRIPTION

The TIP41CN is a silicon base island technology NPN power transistor Jedec TO-220 plastic package with improved performances than the industry standard TIP41C that make this device suitable for audio, power linear and switching applications.

The complementary PNP type is TIP42CN.

Figure 1: Package

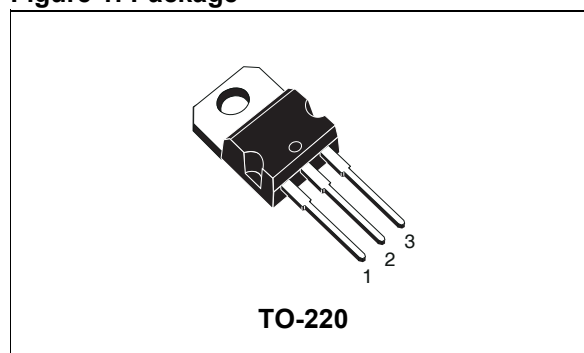


Figure 2: Internal Schematic Diagram

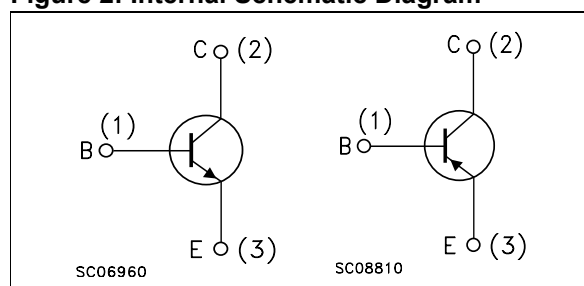


Table 1: Order Codes

Part Number	Marking	Package	Packaging
TIP41CN (#)	TIP41C NR TIP41C NO TIP41C NY	TO-220	Tube
TIP42CN (#)	TIP42C NR TIP42C NO TIP42C NY	TO-220	Tube

# See:note on page 2

Table 2: Absolute Maximum Ratings

Symbol	Parameter	Value		Unit
		NPN	TIP41CN	
		PNP	TIP42CN	
$V_{CBO}$	Collector-Base Voltage ( $I_E = 0$ )		100	V
$V_{CEO}$	Collector-Emitter Voltage ( $I_B = 0$ )		100	V
$V_{EBO}$	Emitter-Base Voltage ( $I_C = 0$ )		5	V
$I_C$	Collector Current		6	A
$I_{CM}$	Collector Peak Current ( $t_p < 5ms$ )		10	A

May 2005

Rev. 1

1/8

Symbol	Parameter	Value		Unit
		NPN	TIP41CN	
		PNP	TIP42CN	
$I_B$	Base Current	3		A
$P_{tot}$	Total Dissipation at $T_C \leq 25\text{ }^\circ\text{C}$	65		W
$T_{stg}$	Storage Temperature	-65 to 150		$^\circ\text{C}$
$T_J$	Max. Operating Junction Temperature	150		$^\circ\text{C}$

For PNP types voltage and current values are negative.

**Table 3: Electrical Characteristics ( $T_{case} = 25\text{ }^\circ\text{C}$  unless otherwise specified)**

Symbol	Parameter	Test Conditions	Min.	Typ.	Max.	Unit
$I_{CEO}$	Collector Cut-off Current ( $I_B = 0$ )	$V_{CE} = 60\text{ V}$			0.7	mA
$I_{EBO}$	Emitter Cut-off Current ( $I_C = 0$ )	$V_{EB} = 5\text{ V}$			1	mA
$I_{CES}$	Collector Cut-off Current ( $V_{BE} = 0$ )	$V_{CE} = 100\text{ V}$			0.4	mA
$V_{CEO(sus)}^*$	Collector-Emitter Sustaining Voltage ( $I_B = 0$ )	$I_C = 30\text{ mA}$	100			V
$V_{CE(sat)}^*$	Collector-Emitter Saturation Voltage	$I_C = 6\text{ A}$ $I_B = 0.6\text{ A}$			1.5	V
$V_{BE(on)}^*$	Base-Emitter Voltage	$I_C = 6\text{ A}$ $V_{CE} = 4\text{ V}$			2	V
$h_{FE}^*$	DC Current Gain	$I_C = 0.3\text{ A}$ $V_{CE} = 4\text{ V}$	30			
		$I_C = 3\text{ A}$ $V_{CE} = 4\text{ V}$				
		Group R	15		28	
		Group O	24		44	
		Group Y	42		75	

\* Pulsed: Pulsed duration = 300  $\mu\text{s}$ , duty cycle  $\leq 2\%$ .

For PNP types voltage and current values are negative.

# Note: Product is pre-selected in DC current gain (Group R, Group O and Group Y). STMicroelectronics reserves the right to ship either groups according to production availability. Please contact your nearest STMicroelectronics sales office for delivery details.

Figure 3: DC Current Gain (NPN)

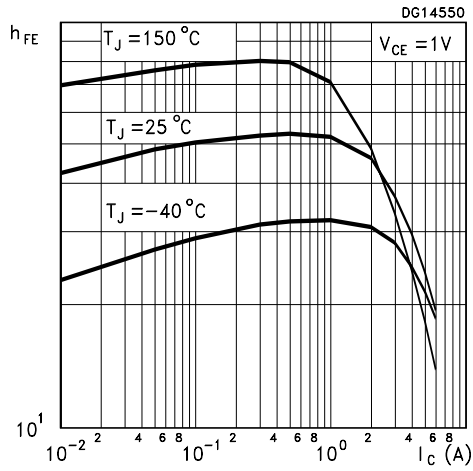


Figure 4: DC Current Gain (NPN)

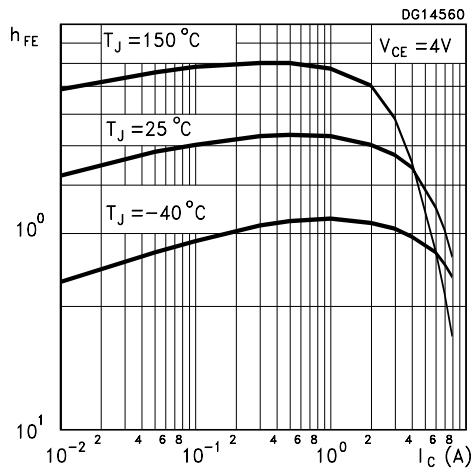


Figure 5: Collector-Emitter Saturation Voltage (NPN)

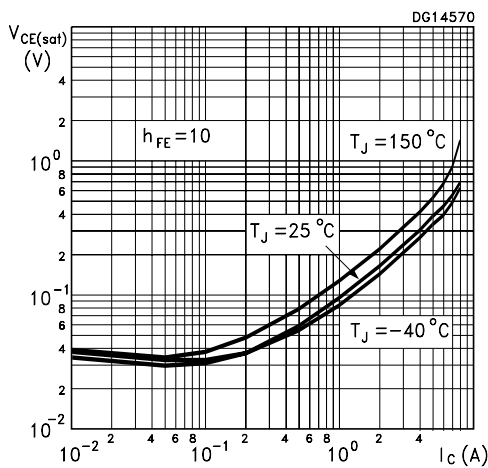


Figure 6: DC Current Gain (PNP)

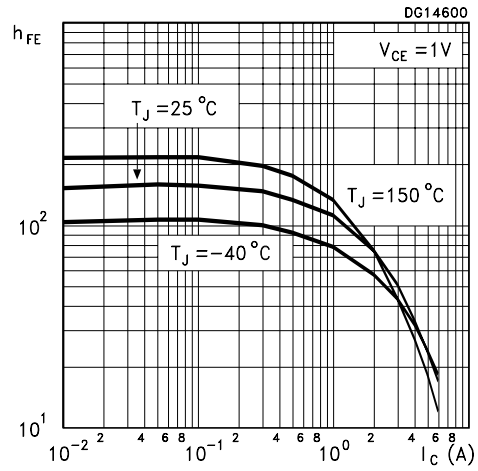


Figure 7: DC Current Gain (PNP)

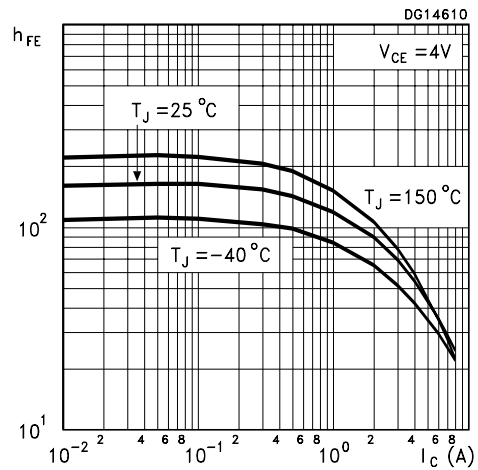


Figure 8: Collector-Emitter Saturation Voltage (PNP)

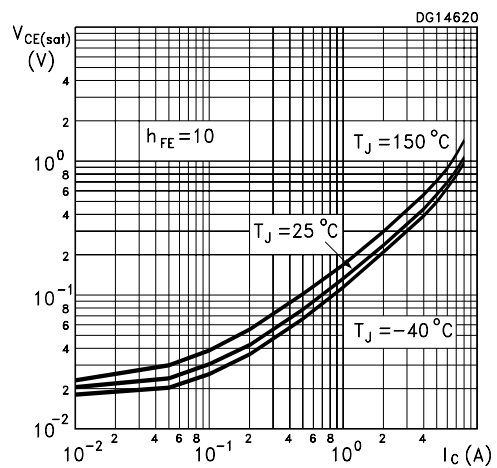


Figure 9: Base-Emitter Saturation Voltage (NPN)

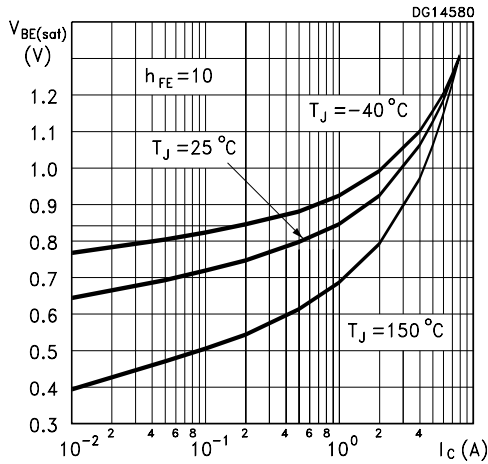


Figure 10:  $BT_{(ON)}$  Time (NPN)

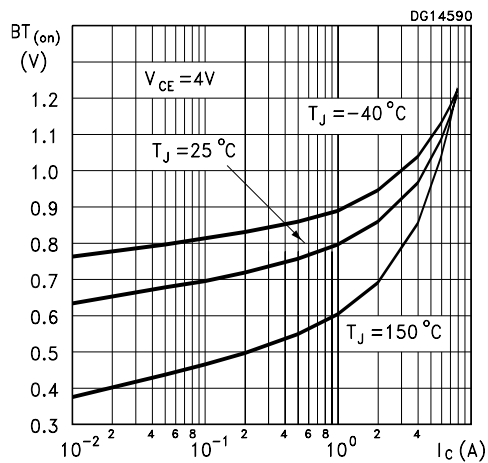


Figure 11: Resistive Load Switching Time (NPN)

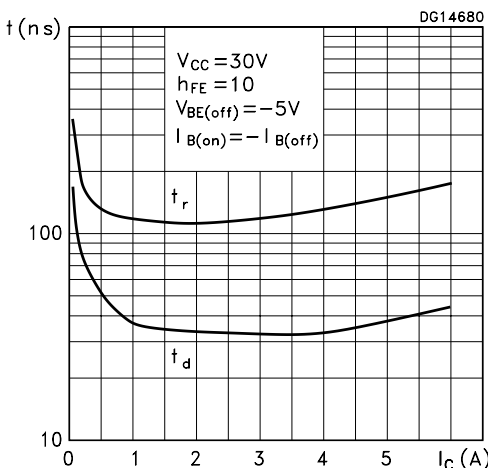


Figure 12: Base-Emitter Saturation Voltage (PNP)

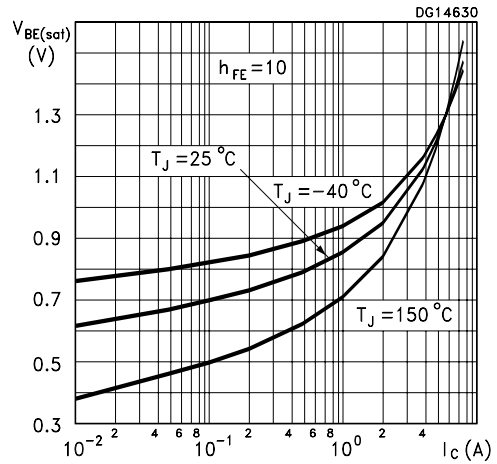


Figure 13:  $BT_{(ON)}$  Time (PNP)

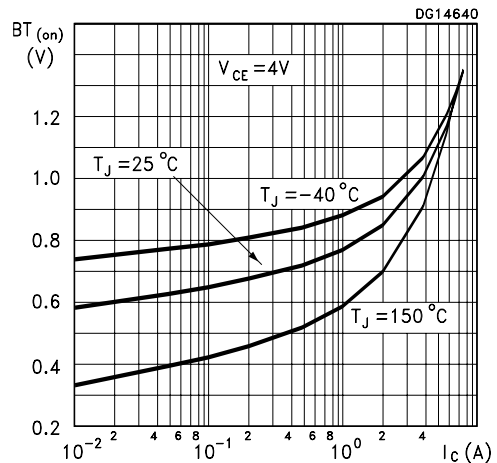
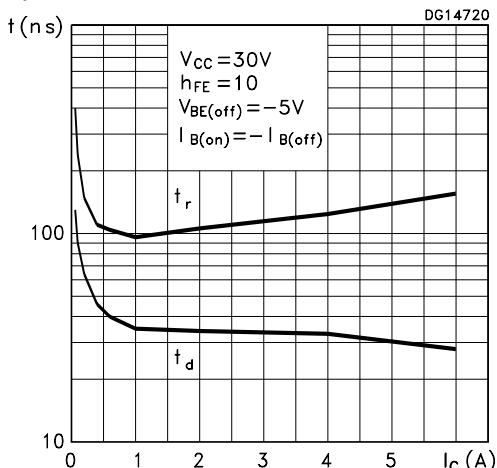
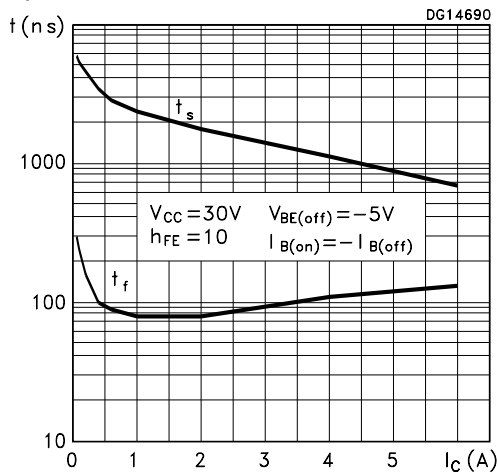


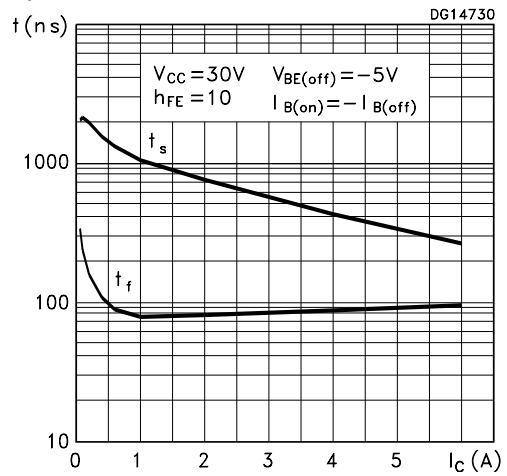
Figure 14: Resistive Load Switching Time (PNP)



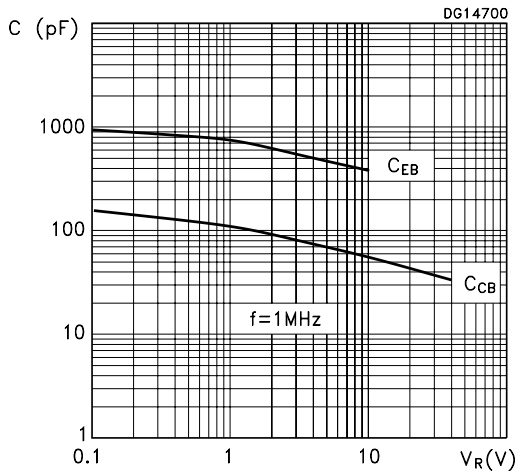
**Figure 15: Resistive Load Switching Time (NPN)**



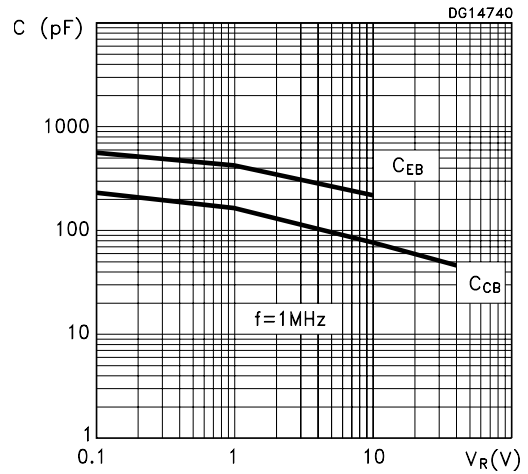
**Figure 17: Resistive Load Switching Time (PNP)**



**Figure 16: Collector-Base e Collector-Emitter Capacitance (NPN)**

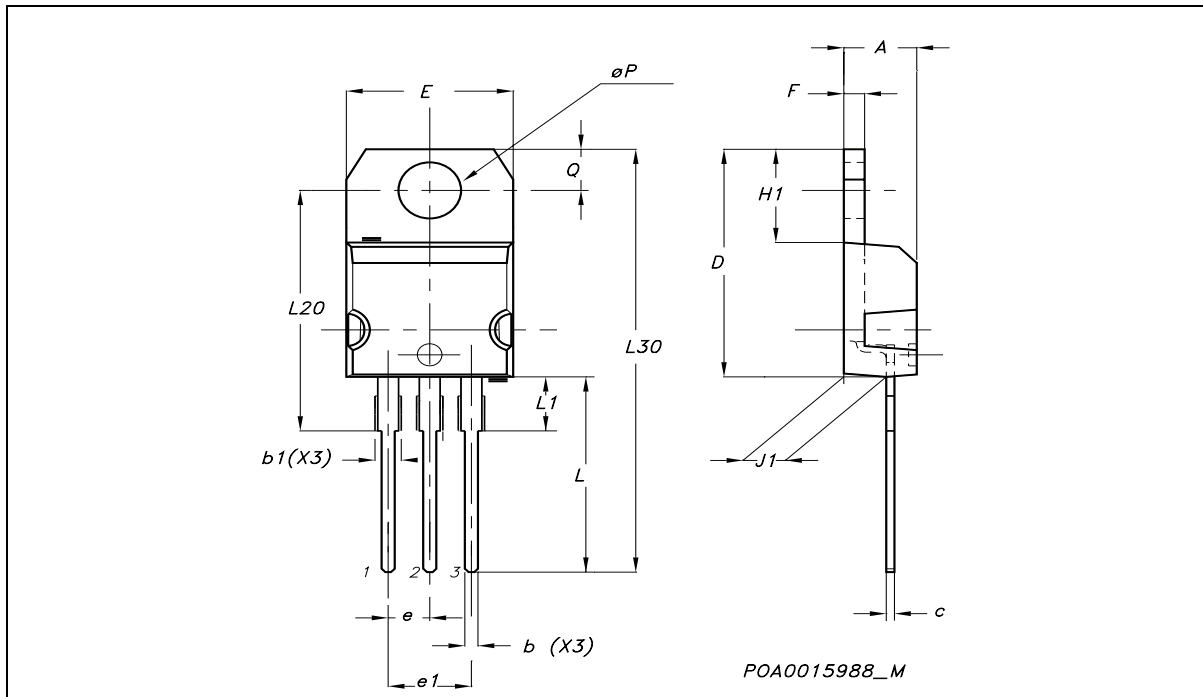


**Figure 18: Collector-Base e Collector-Emitter Capacitance (PNP)**



**TO-220 MECHANICAL DATA**

DIM.	mm.			inch		
	MIN.	TYP	MAX.	MIN.	TYP.	MAX.
A	4.40		4.60	0.173		0.181
b	0.61		0.88	0.024		0.034
b1	1.15		1.70	0.045		0.066
c	0.49		0.70	0.019		0.027
D	15.25		15.75	0.60		0.620
E	10		10.40	0.393		0.409
e	2.40		2.70	0.094		0.106
e1	4.95		5.15	0.194		0.202
F	1.23		1.32	0.048		0.052
H1	6.20		6.60	0.244		0.256
J1	2.40		2.72	0.094		0.107
L	13		14	0.511		0.551
L1	3.50		3.93	0.137		0.154
L20		16.40			0.645	
L30		28.90			1.137	
øP	3.75		3.85	0.147		0.151
Q	2.65		2.95	0.104		0.116



**Table 4:**

Version	Release Date	Change Designator
18-Mar-2005	1	First release.
06-Apr-2005	2	Further curves have been added.

Information furnished is believed to be accurate and reliable. However, STMicroelectronics assumes no responsibility for the consequences of use of such information nor for any infringement of patents or other rights of third parties which may result from its use. No license is granted by implication or otherwise under any patent or patent rights of STMicroelectronics. Specifications mentioned in this publication are subject to change without notice. This publication supersedes and replaces all information previously supplied. STMicroelectronics products are not authorized for use as critical components in life support devices or systems without express written approval of STMicroelectronics.

The ST logo is a registered trademark of STMicroelectronics  
All other names are the property of their respective owners

© 2005 STMicroelectronics - All Rights Reserved

STMicroelectronics group of companies

Australia - Belgium - Brazil - Canada - China - Czech Republic - Finland - France - Germany - Hong Kong - India - Israel - Italy - Japan -  
Malaysia - Malta - Morocco - Singapore - Spain - Sweden - Switzerland - United Kingdom - United States of America  
**www.st.com**