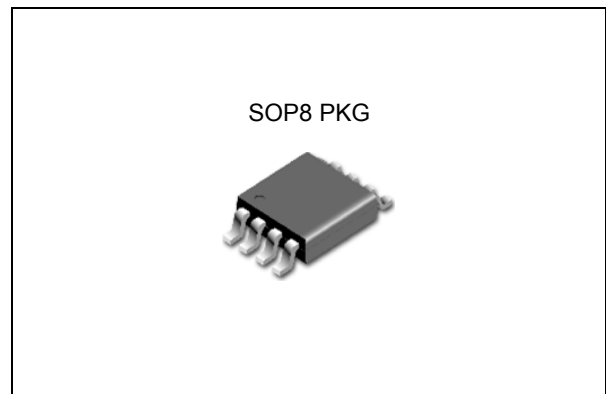

FEATURES

- 2.7V to 5.5V Operating Range
- 500mA Continuous Current per Channel
- 1.25A Maximum Short Circuit Current limit
- 90uA Typical On-State Supply Current
- 1uA Maximum Standby Supply Current
- Independent open-drain fault flag pins
- Thermal Shutdown Protection
- 2.4V typical Under Voltage Lockout(UVLO)
- TJ2205H : Active High version
- TJ2205L : Active Low version
- UL Recognized. UL File No. E347996

**APPLICATION**

- USB Peripherals
- General Purpose Power Switching
- ACPI Power Distribution
- Notebook PCs
- PDAs
- Hot Plug-in Power Supplies

ORDERING INFORMATION

Device	Package
TJ2205HD	SOP8
TJ2205LD	

DESCRIPTION

The TJ2205X is dual-channel High-Side MOSFET switches optimized for general-purpose power distribution requiring circuit protection.

The TJ2205 series support the following USB requirements. Each of the two channels supplies up to 500mA as required by USB downstream devices. Each switch's low on-resistance meets USB voltage drop requirements. Fault current is limited to typically 1.2A. Flag output indicates fault conditions to the local USB controller. Soft-start prevents the transient voltage drop on the upstream port that can occur when the switch is enabled in bus-powered applications. Under voltage lockout (UVLO) feature disables the output switches until a valid input voltage. Also the TJ2205 include thermal shutdown to prevent switch failure from high-current loads.

Absolute Maximum Ratings (Note 1)

Characteristic	Symbol	Min	Max	Unit
Supply Voltage	V_{IN}	-0.3	6.0	V
Enable Input Voltage (Note 2)	V_{EN}	-0.3	6.0	V
Fault Flag Voltage	V_{FLAG}	-	6.0	V
Fault Flag Current	I_{FLAG}	-	25	mA
Output Voltage	V_{OUT}		6.0	V
Output Current	I_{OUT}		Internally Limited	
Storage Temperature Range	T_{STG}	-65	150	°C

Operating Ratings (Note 3)

Characteristic	Symbol	Min	Max	Unit
Supply Voltage	V_{IN}	2.7	5.5	V
Ambient Temperature Range	T_A	-40	85	°C
Operating Junction Temperature Range	T_J	-40	125	°C
Thermal Resistance SOP Junction to Ambient	θ_{JA}	-	165	°C/W
Thermal Resistance SOP Junction to Case	θ_{JC}	-	26	°C/W

Note:

1. Exceeding the absolute maximum ratings may damage the device.
2. It is recommended for V_{EN} voltage not to exceed V_{IN} voltage.
3. The device is not guaranteed to function outside its operating rating.
4. Devices are ESD sensitive. Handling precautions are recommended.

Ordering Information

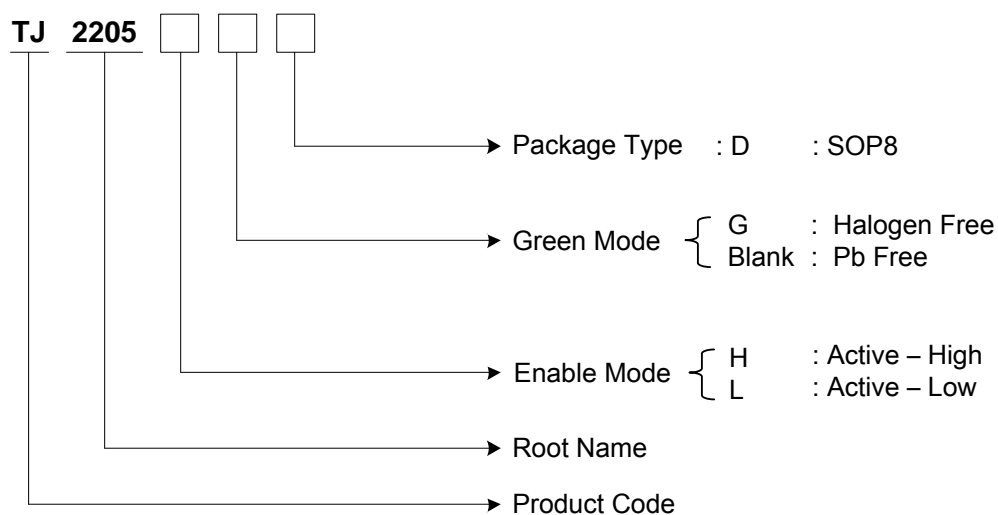

TYPICAL APPLICATION CIRCUIT

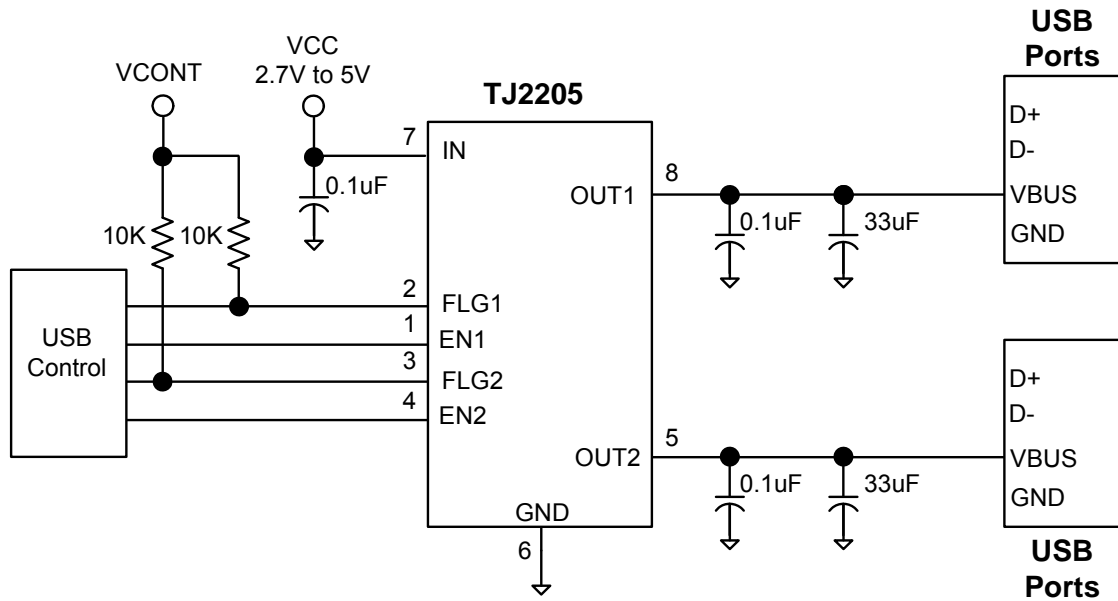

FUNCTION BLOCK DIAGRAM

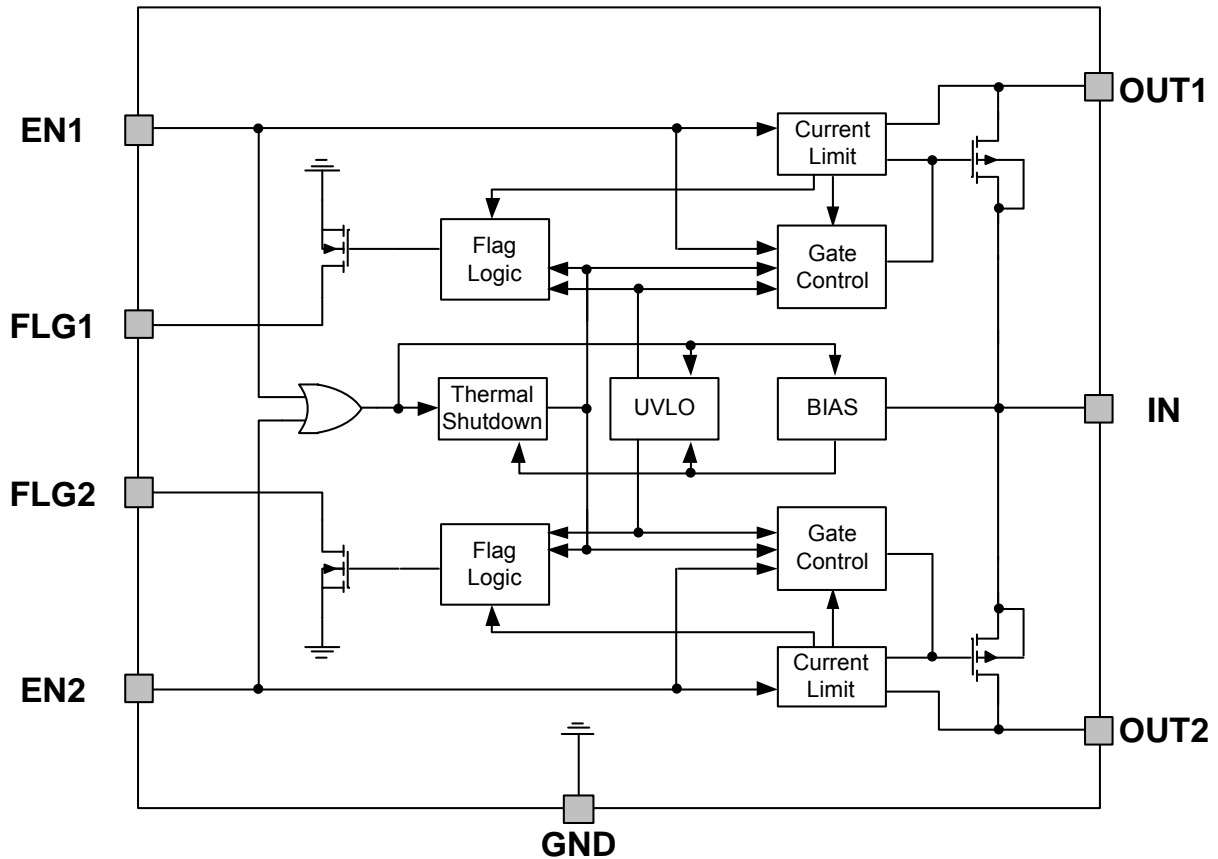

PIN CONFIGURATION

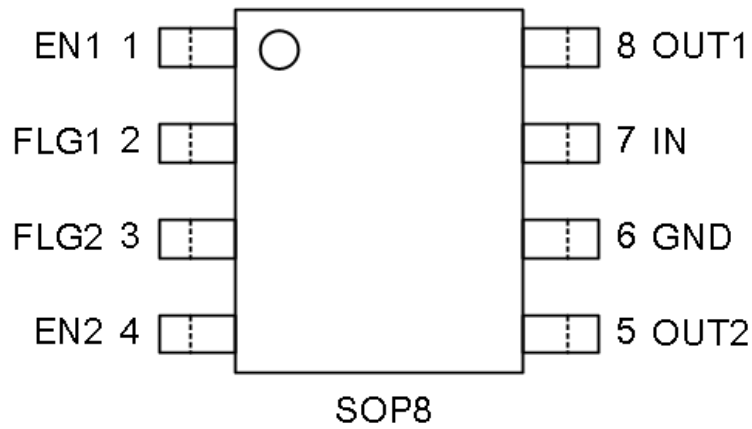

PIN DESCRIPTION

Pin No.	Pin Name	Pin Description & Function
1	EN1	Enable1: Logic-Compatible enables input. (H: active high, L: active low). Do not float.
2	FLG1	Fault Flag1: Active-low, open-drain output. Indicates Short circuit, UVLO and Thermal shutdown.
3	FLG2	Fault Flag2: Active-low, open-drain output. Indicates Short circuit, UVLO and Thermal shutdown.
4	EN2	Enable2: Logic-Compatible enables input. (H: active high, L: active low). Do not float.
5	OUT2	Switch Output2: Output MOSFET source. Typically connect to switched side of load.
6	GND	Ground
7	IN	Supply Input: Output MOSFET drain. Also supplies IC's internal circuitry. Connect to positive supply.
8	OUT1	Switch Output1: Output MOSFET source. Typically connect to switched side of load.

ELECTRICAL CHARACTERISTICS (Under the conditions of $V_{IN}=+5V$ and $T_A=25^{\circ}C$)

PARAMETER	Symbol	CONDITIONS	MIN	TYP	MAX	UNITS
Operating Voltage Range	V_{IN}		2.7		5.5	V
Supply Current	I_{CC}	Enable off ,OUT=Open		0.05	1	μA
		Enable on, OUT=Open		90	160	μA
Enable Input Threshold Voltage	V_{EN}	(Note 5)	0.8	1.7	2.4	V
Enable Input Current	I_{EN}	$V_{EN} = 0V$ to $5.5V$	-1	0.01	1	μA
Enable Input Capacitance	C_{EN}			1		pF
Switch Resistance	$R_{DS(ON)}$	$V_{IN}=5V, I_{OUT}=500mA$		160	200	m Ω
		$V_{IN}=3.3V, I_{OUT}=500mA$		200	230	m Ω
Output Turn-On Delay	T_{DON}	$RL=10\Omega$ each output, $CL=1\mu F$		50		μs
Output Turn-On Rise Time	T_R	$RL=10\Omega$ each output, $CL=1\mu F$		40		μs
Output Turn-Off Delay	T_{DOFF}	$RL=10\Omega$ each output, $CL=1\mu F$		0.5	10	μs
Output Turn-Off Fall Time	T_F	$RL=10\Omega$ each output, $CL=1\mu F$		0.5	10	μs
Output leakage Current	I_{LEAK}	$V_{ENX} \leq 0.8V$		0.01	5	μA
Current Limit Threshold	I_{LIM}	Ramped load applied to output	1.0	1.2	1.4	A
Short Circuit Current Limit	I_{OS}	each output, $V_{OUT}=0V$	0.7	1.0	1.25	A
Over-Temperature Shutdown Threshold	T_{TS}	Temperature increasing switch		145		$^{\circ}C$
		Temperature decreasing switch		135		$^{\circ}C$
Error Flag Output Resistance	R_{FO}	$V_{IN}=5V, I_L=10mA$		10	25	Ω
		$V_{IN}=3.3V, I_L=10mA$		15	40	Ω
Error Flag Off Current	I_{FOH}	$V_{FLAG}=5V$		0.01	10	μA
UVLO Threshold	UVLO	$V_{IN} =$ increasing	2.3	2.5	2.7	V
		$V_{IN} =$ decreasing	2.1	2.3	2.5	V
Overcurrent Flag Response Delay	T_{DFOV}	$V_{IN}=5V,$ apply $V_{OUT}=0V$ until FLG low		0.45		ms

Note:

5. OFF is $V_{EN} \leq 0.8V$ and ON is $V_{EN} \geq 2.4V$ for the TJ2205H. OFF is $V_{EN} \geq 2.4V$ and ON is $V_{EN} \leq 0.8V$ for the TJ2205L.

Test Circuit

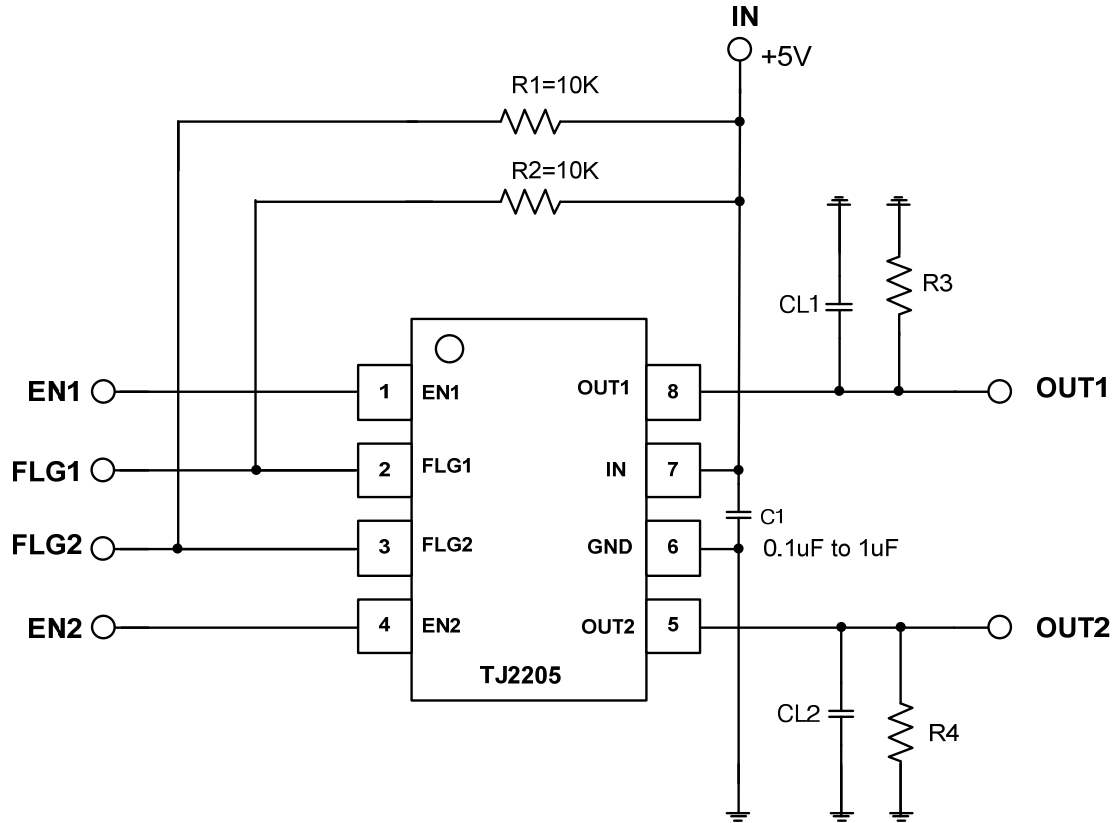

TYPICAL PERFORMANCE CHARACTERISTICS

ON-Resistance vs. Temperature

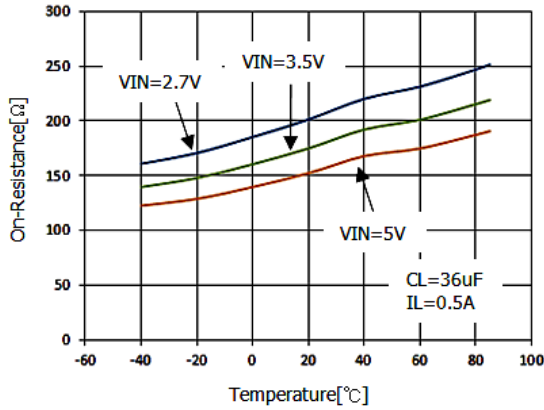

ON-Resistance vs. Supply Voltage

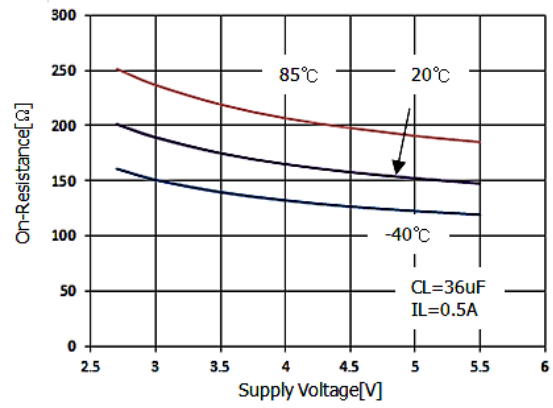

On-Current vs. Temperature

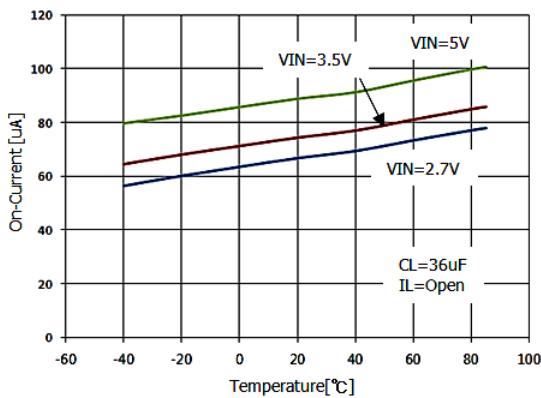

On-Current vs. Supply Voltage

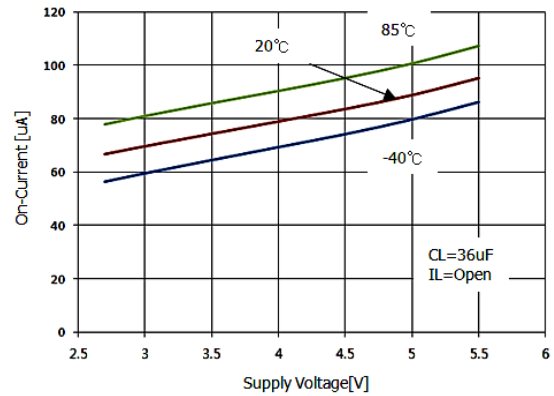

Enable Threshold vs. Temperature

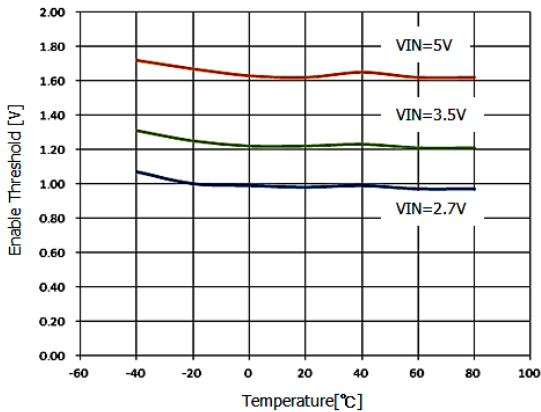

Enable Threshold vs. supply Voltage

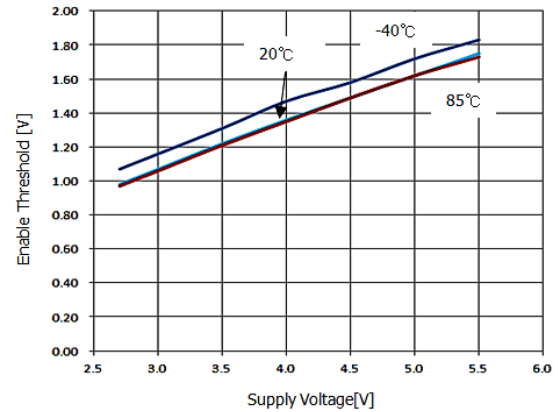

TYPICAL PERFORMANCE CHARACTERISTICS (Continued)

Turn-On Delay Time vs. Temperature

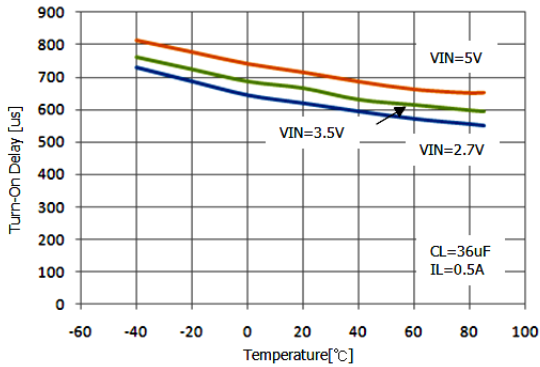

Turn-On Delay Time vs. Supply voltage

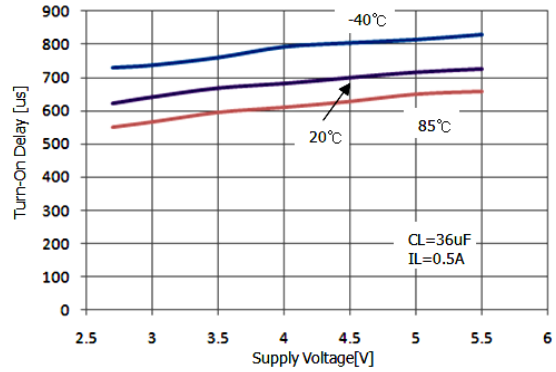

Turn-On Rise Time vs. Temperature

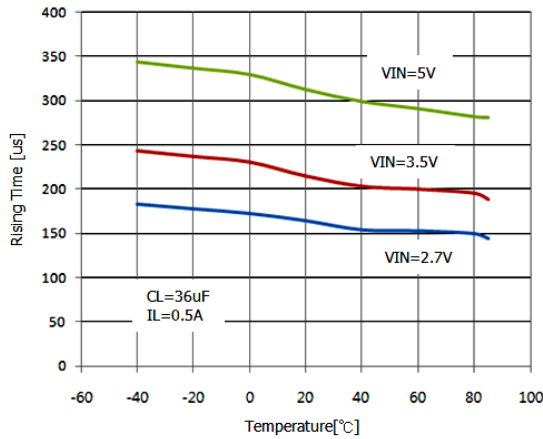

Turn-On Rise Time vs. Supply Voltage

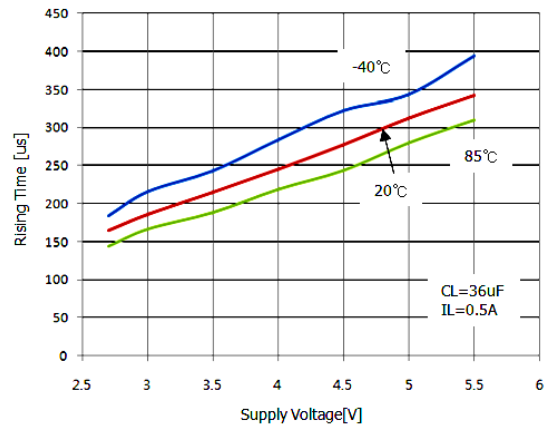

Turn-Off Fall Time vs. Temperature

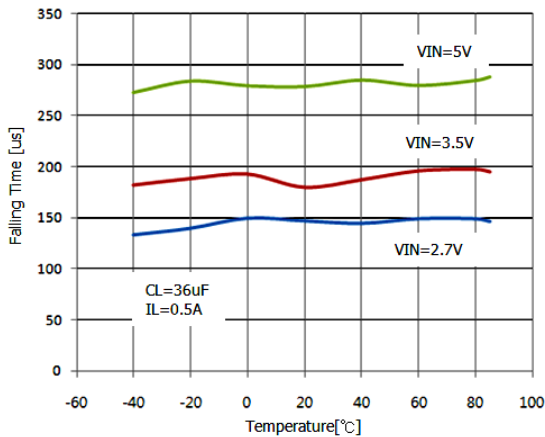

Turn-Off Fall Time vs. Supply Voltage

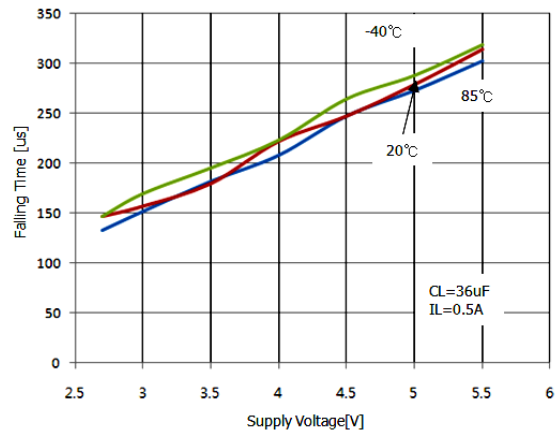

TYPICAL PERFORMANCE CHARACTERISTICS (Continued)

Current Limit Threshold vs. Temperature

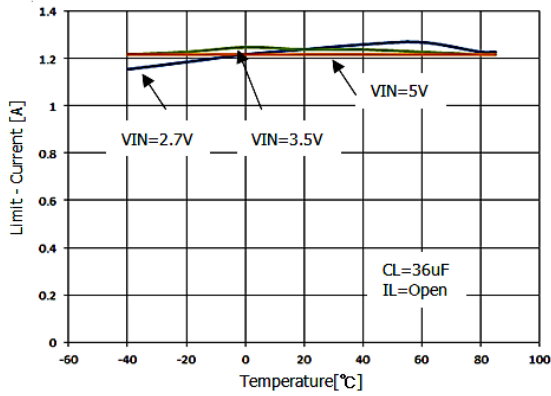

Current Limit Threshold vs. Supply Voltage

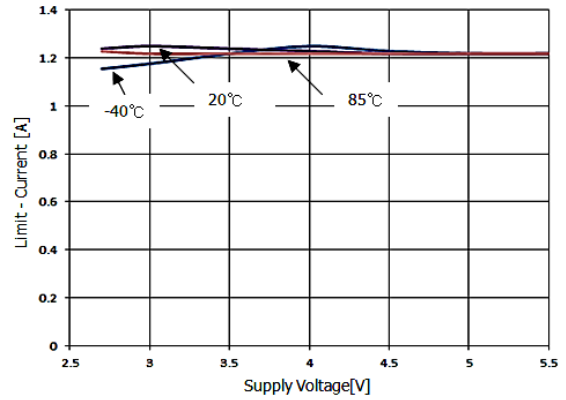

Short Circuit Current vs. Temperature

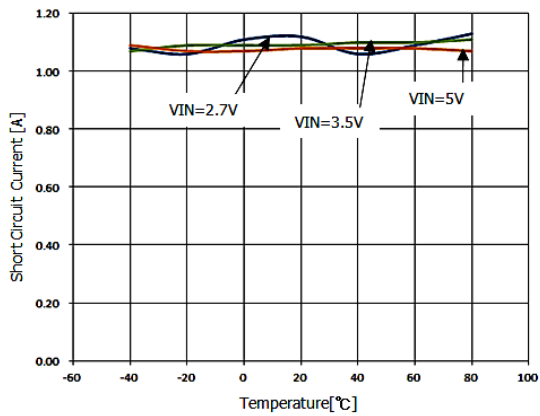

UVLO vs. Temperature

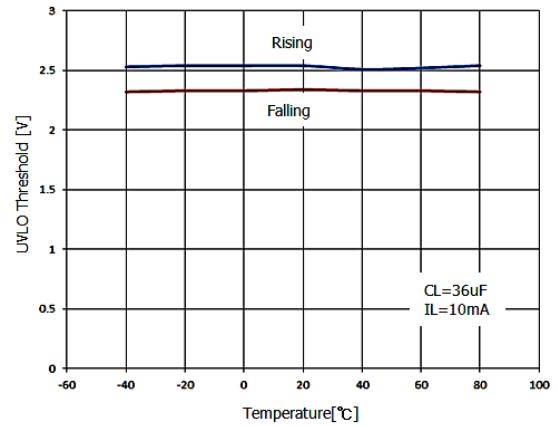

TYPICAL OPERATING CHARACTERISTICS

- VIN=5V, C1=1uF, VEN=VIN, TA=25°C, unless otherwise noted

Turn – ON / Turn-OFF

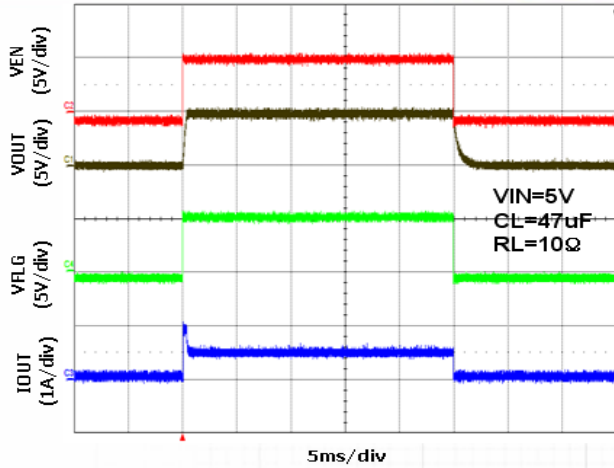

Turn – ON

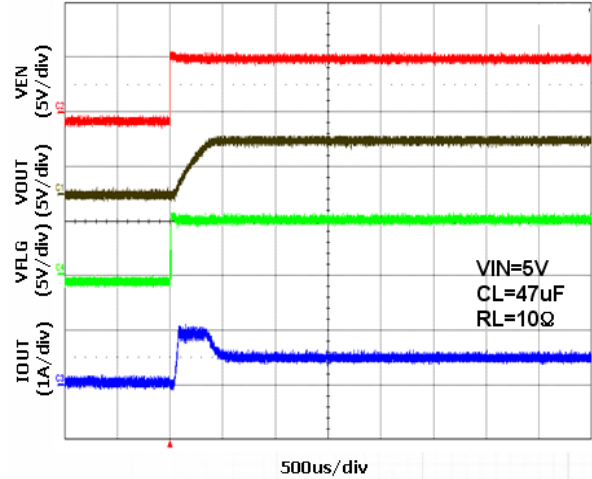

Turn – OFF

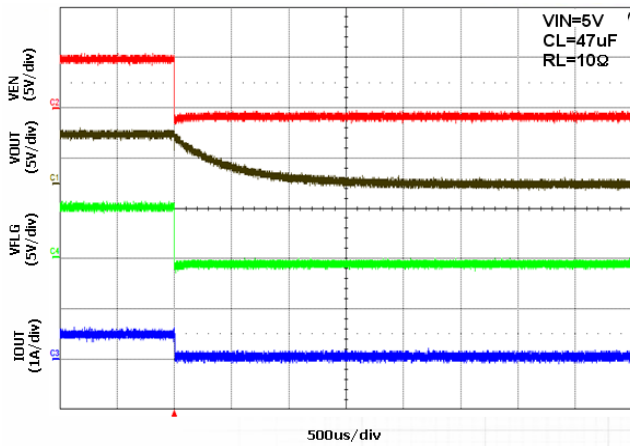

Inrush Current Response

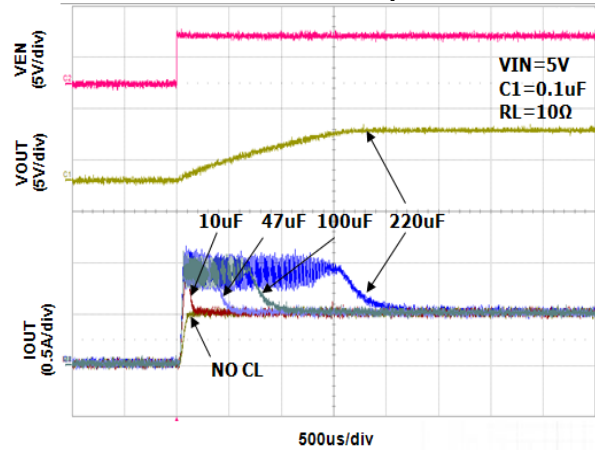

Enable Into Short
(TJ2205H)

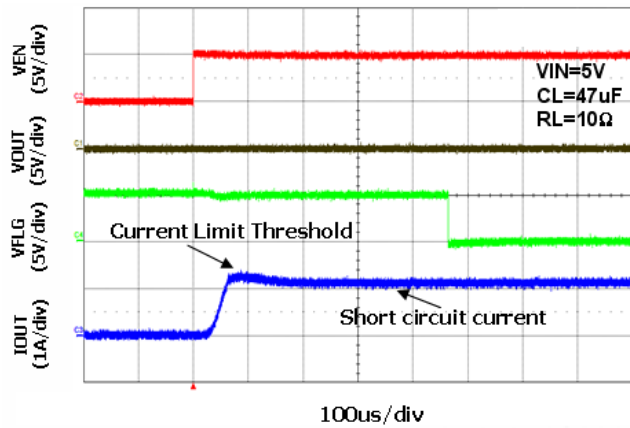

Thermal Shutdown

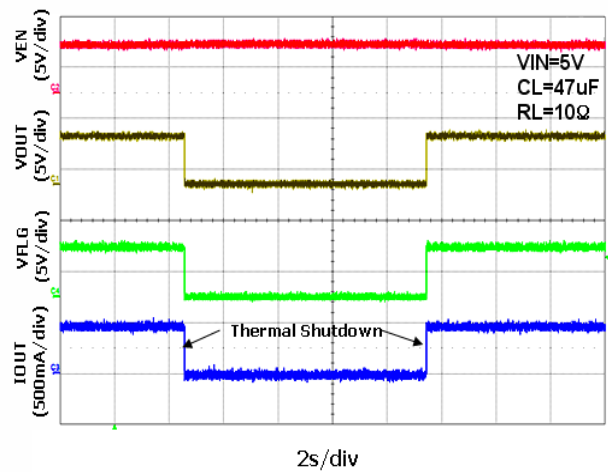

TYPICAL OPERATING CHARACTERISTICS (continued)

UVLO – VIN Rising

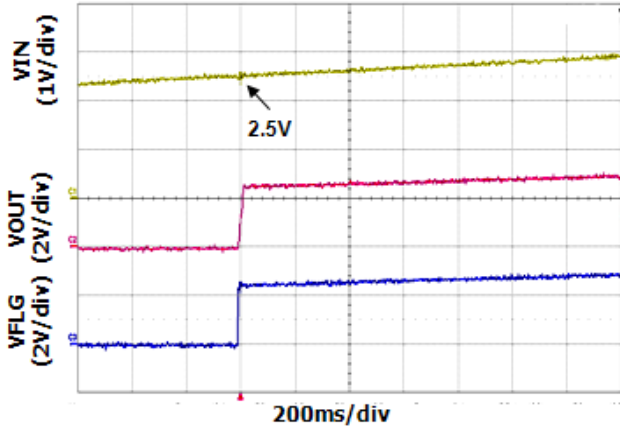

UVLO – VIN Falling

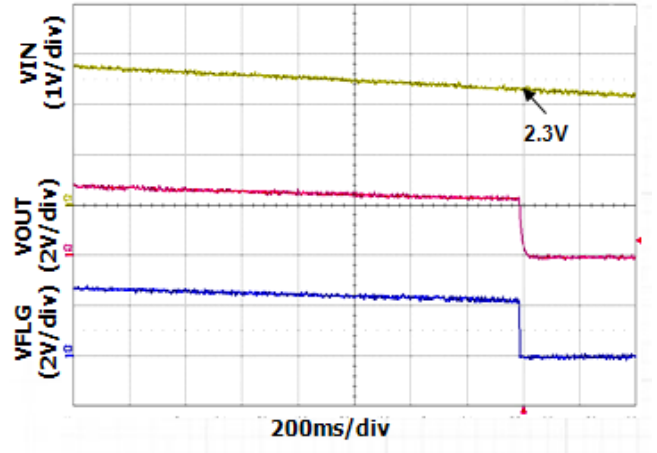

Function Description

Supply Filtering

A 0.1uF to 1uF bypass capacitor from IN pin to GND pin is recommended to control power supply transients. Without this bypass capacitor, an output short can cause ringing from supply lead inductance on the input and damage the internal control circuitry.

Input or output transients must never exceed the absolute maximum supply voltage ($V_{INmax} = 6V$)

Power Dissipation

The device's junction temperature depends on several factors such as the load, PCB layout, ambient temperature, and package type. Equations that can be used to calculate power dissipation of each channel and junction temperature are found below:

$$P_D = R_{DS(ON)} \times I_{OUT}^2$$

Total power dissipation of the device will be the summation of P_D for both channels. To relate this to junction temperature, the following equation can be used:

$$T_J = P_D \times \Theta_{JA} + T_A$$

Where:

T_J = Junction temperature

T_A = Ambient temperature

Θ_{JA} = Thermal resistance of the package

Enable/Shutdown

The EN1 and EN2 control pins must be driven to a logic high or logic low for a clearly defined signal input. Floating these control lines may cause unpredictable operation.

Fault Flag

The FLG signal is open-drained output of N-channel MOSFET, the FLG output is pulled low to signal the following fault conditions: input under voltage, output to GND short, and thermal shutdown.

Soft-Start Condition

The TJ2205 has high impedance when off, which gradually shifts to low impedance as the chip turns on. This prevents an inrush current from causing voltage drops that result from charging a capacitive load and can pull the USB voltage bus below specified levels. This satisfies the USB voltage droop requirements for bus-powered applications.

The TJ2205 can provide inrush current limiting for applications with large load capacitances where $C_L > 10\mu F$.

Current Sense

A sense MOSFET monitors the current supplied to the load. The sense MOSFET measures current more efficiently than conventional resistance methods. When an overload or short circuit is encountered, the current-sense circuitry sends a control signal to the driver. The driver in turn reduces the gate-source voltage and drives the power MOSFET into its saturation region, which switches the output into a constant-current mode and holds the current constant while varying the voltage on the load.

Over-Current and Short-Circuit Protection

The TJ2205 features an over-current protection circuitry to protect the device against overload conditions. The current limit threshold is preset internally. It protects the output MOSFET switches from damage due to undesirable short circuit conditions of excess inrush current often encountered during hot plug-in. The low limit of the current limit threshold of the TJ2205 allows a minimum current of 0.5A through the

MOSFET switches. A current limit condition will signal the error flag. These features can protect the load system effectively at any accidental circumstances.

Thermal Shutdown Protection

Thermal shutdown limits the TJ2205 junction temperature and protects the device from damage as a result of overheated.

Thermal protection turns off when the TJ2205's junction temperature 145°C reached, allowing it to cool down until 135°C. The TJ2205 is reactivated when a junction temperature drops to approximately 130°C. It depends on the power dissipation, thermal resistance, and ambient temperature.

Under Voltage Lockout

Under Voltage Lockout (UVLO) prevents the output MOSFET from turning on until V_{IN} exceeds approximately 2.5V. After the switch turns on, if the voltage drops below 2.3V typically, UVLO shuts off the output MOSFET. Under voltage detection functions only when the switch is enabled.

Printed Circuit Layout

The power circuitry of USB printed circuit boards requires a customized layout to maximize thermal dissipation and to minimize voltage drop and EMI.

USB Compliance

The TJ2205 is ideal for self-powered and bus powered Universal Serial Bus (USB) applications. A USB port provides a +5.0V bus and ground return line in addition to a twisted pair for data.

The TJ2205 will comply with the following USB requirements:

- 1) The fault current is well below the UL 25VA safety requirements.
- 2) The Flag Outputs are available to indicate fault conditions to USB controllers.
- 3) The MOSFET switches' low on-resistance meets USB voltage drop requirements.
- 4) Each MOSFET switch channel can supply 500mA as required by USB downstream devices.
- 5) Soft start eliminates any momentary voltage drops on the upstream port that may occur when the switches are enabled in bus-powered applications.
- 6) An Under-voltage Lockout ensures that the device remains off unless there is a valid input supply voltage present.
- 7) +2.7V and +5.0V logic compatible enable inputs.
- 8) Thermal Shutdown prevents the possibility of catastrophic switch failure from high-current loads.
- 8) The device is available in both active-high and active-low versions.

Table 1. USB Protocol Compliance of the TJ2205 device

USB REQUIREMENT	TJ2205 COMPLIANT FEATURE
Inrush Current limiting required	Soft Start turns on in 1ms
Suspend State of <500uA Required	Suspend Current of 1uA Maximum
Bus powered hubs must have 350mV drop from cable plug to port.	Switch on resistance of 200mΩ maximum (translates to 100mV at 500mA)
Voltage supplied to host or hub port is +4.75V to +5.25V	Operating range of +2.7V to +5.5V
A device that draws bus power must have a stable supply within 100ms of VBUS reaching +4.4V	Turn on in 1ms
Over-Current reporting capability required	Open drain fault flags.