

## FEATURES

- Ultra Low Dropout Voltage
- Compatible with low ESR MLCC as Input / Output Capacitor
- Good Line and Load Regulation
- Guaranteed Output Current of 1A
- Available in SOP8, SOP8-PP, SOT-89-5L, DFN2X3-8L Packages
- Fixed Output: 1.0V, 1.2V, 1.5V, 1.8V, 2.5V, and 3.3V
- VOUT Power OK Signal
- Programmable Soft-Start Function
- Output Auto Discharge Function
- Over-Temperature/Over-Current Protection

## APPLICATION

- LCD TVs and SETTOP Boxes
- Battery Powered Equipment
- Motherboards and Graphic Cards
- Microprocessor Power Supplies
- Peripheral Cards
- High Efficiency Linear Regulators
- Battery Chargers

## DESCRIPTION

The TJ4310 series of high performance ultra-low dropout linear regulators operates from 2.5V to 5.5V input supply and provides ultra-low dropout voltage, high output current with low ground current. Wide range of preset output voltage options are available. These ultra-low dropout linear regulators respond fast to step changes in load which makes them suitable for low voltage micro-processor applications. The TJ4310 is developed on a CMOS process technology which allows low quiescent current operation independent of output load current. This CMOS process also allows the TJ4310 to operate under extremely low dropout conditions.

## ABSOLUTE MAXIMUM RATINGS (Note 1)

CHARACTERISTIC	SYMBOL	MIN.	MAX.	UNIT
Input Supply Voltage (Survival)	$V_{IN}$	-	6.5	V
Maximum Output Current	$I_{MAX}$	-	1	A
Lead Temperature (Soldering, 5 sec)	$T_{SOL}$		260	°C
Storage Temperature Range	$T_{STG}$	-65	150	°C
Operating Junction Temperature Range	$T_{JOPR}$	-40	125	°C
Package Thermal Resistance *	$\Theta_{JA-SOP8-PP}$	68		°C/W

\* Calculated from package in still air, mounted to 2.6mm X 3.5mm(minimum foot print) 2 layer PCB without thermal vias per JESD51 standards.

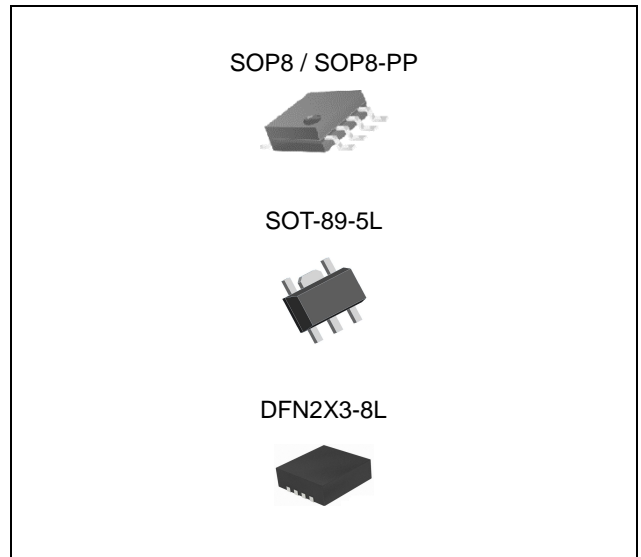

## ORDERING INFORMATION

Device	Package
TJ4310GD-ADJ	SOP8
TJ4310GD-X.X	
TJ4310GDP-ADJ	SOP8-PP
TJ4310GDP-X.X	
TJ4310GF-ADJ	SOT-89-5L
TJ4310GQ-ADJ	DFN2X3-8L

X.X = Output Voltage = 1.0, 1.2, 1.5, 1.8, 2.5, and 3.3

# 1A Ultra Low Dropout Linear Regulator

# TJ4310

## OPERATING RATINGS (Note 2)

CHARACTERISTIC	SYMBOL	MIN.	MAX.	UNIT
Recommend Operating Input Voltage	$V_{IN}$	2.5	5.5	V

## ORDERING INFORMATION

$V_{OUT}$	Package	Order No.	Description	Package Marking	Status
ADJ	SOP8	TJ4310GD-ADJ	1A, Adjustable, Enable, Soft Start, Power Good	TJ4310G	Contact Us
	SOP8-PP	TJ4310GDP-ADJ	1A, Adjustable, Enable, Soft Start, Power Good	TJ4310G	Active
	SOT-89-5L	TJ4310GF-ADJ	1A, Adjustable, Enable	TJ4310G	Active
	DFN2X3-8L	TJ4310GQ-ADJ	1A, Adjustable, Enable, Soft Start, Power Good	4310G	Active
1.0V	SOP8	TJ4310GD-1.0	1A, Enable, Soft Start, Power Good	TJ4310G 1.0	Contact Us
	SOP8-PP	TJ4310GDP-1.0	1A, Enable, Soft Start, Power Good	TJ4310G 1.0	Contact Us
1.2V	SOP8	TJ4310GD-1.2	1A, Enable, Soft Start, Power Good	TJ4310G 1.2	Contact Us
	SOP8-PP	TJ4310GDP-1.2	1A, Enable, Soft Start, Power Good	TJ4310G 1.2	Contact Us
1.5V	SOP8	TJ4310GD-1.5	1A, Enable, Soft Start, Power Good	TJ4310G 1.5	Contact Us
	SOP8-PP	TJ4310GDP-1.5	1A, Enable, Soft Start, Power Good	TJ4310G 1.5	Contact Us
1.8V	SOP8	TJ4310GD-1.8	1A, Enable, Soft Start, Power Good	TJ4310G 1.8	Contact Us
	SOP8-PP	TJ4310GDP-1.8	1A, Enable, Soft Start, Power Good	TJ4310G 1.8	Contact Us
2.5V	SOP8	TJ4310GD-2.5	1A, Enable, Soft Start, Power Good	TJ4310G 2.5	Contact Us
	SOP8-PP	TJ4310GDP-2.5	1A, Enable, Soft Start, Power Good	TJ4310G 2.5	Contact Us
3.3V	SOP8	TJ4310GD-3.3	1A, Enable, Soft Start, Power Good	TJ4310G 3.3	Contact Us
	SOP8-PP	TJ4310GDP-3.3	1A, Enable, Soft Start, Power Good	TJ4310G 3.3	Contact Us

### TJ4310GDP-ADJ

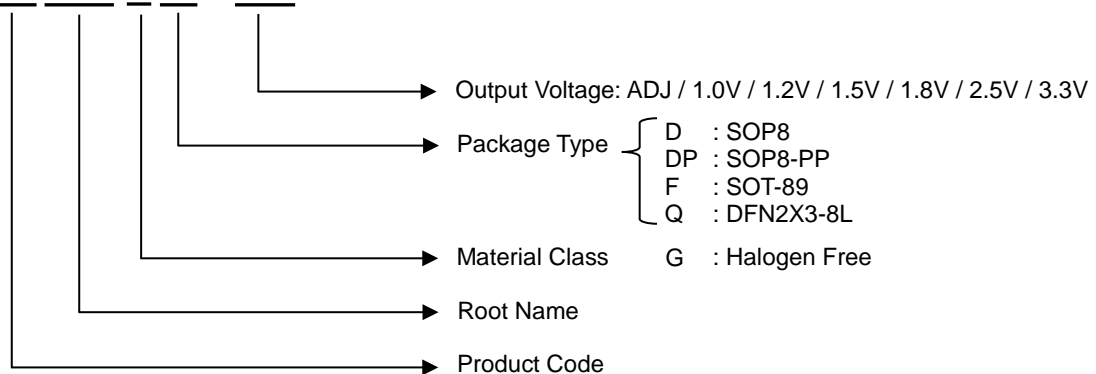

## PIN CONFIGURATION

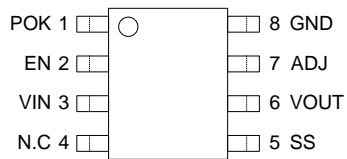

SOP8

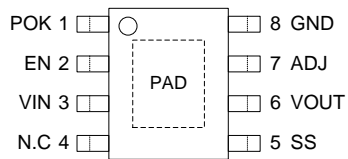

SOP8-PP

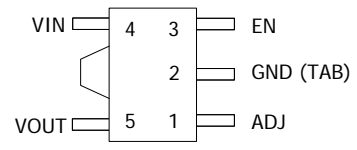

SOT-89-5L

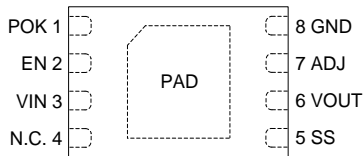

DFN2X3-8L (Top view)

## PIN DESCRIPTION

Pin No.				Pin Name	Pin Function
SOP8	SOP8-PP	SOT-89-5L	DFN2X3-8L		
1	1	-	1	POK	Power OK Indication. This pin is an open-drain output and is set high impedance once $V_{OUT}$ reaches 92% of its rating voltage.
2	2	3	2	EN	Chip Enable. Pulling this pin below 0.4V turns the regulator off. Do not float.
3	3	4	3	VIN	Input Supply.
4	4	-	4	N.C	No connection.
5	5	-	5	SS	Soft-Start. Connect a min. 220pF capacitor between this pin and the ground. Do not connect to ground.
6	6	5	6	VOUT	Output Voltage.
7	7	1	7	ADJ	Output Adjust.
8	8	2	8	GND	Ground.
-	PAD	-	PAD	Thermal Exposed PAD	Connect to ground.

## BLOCK DIAGRAM

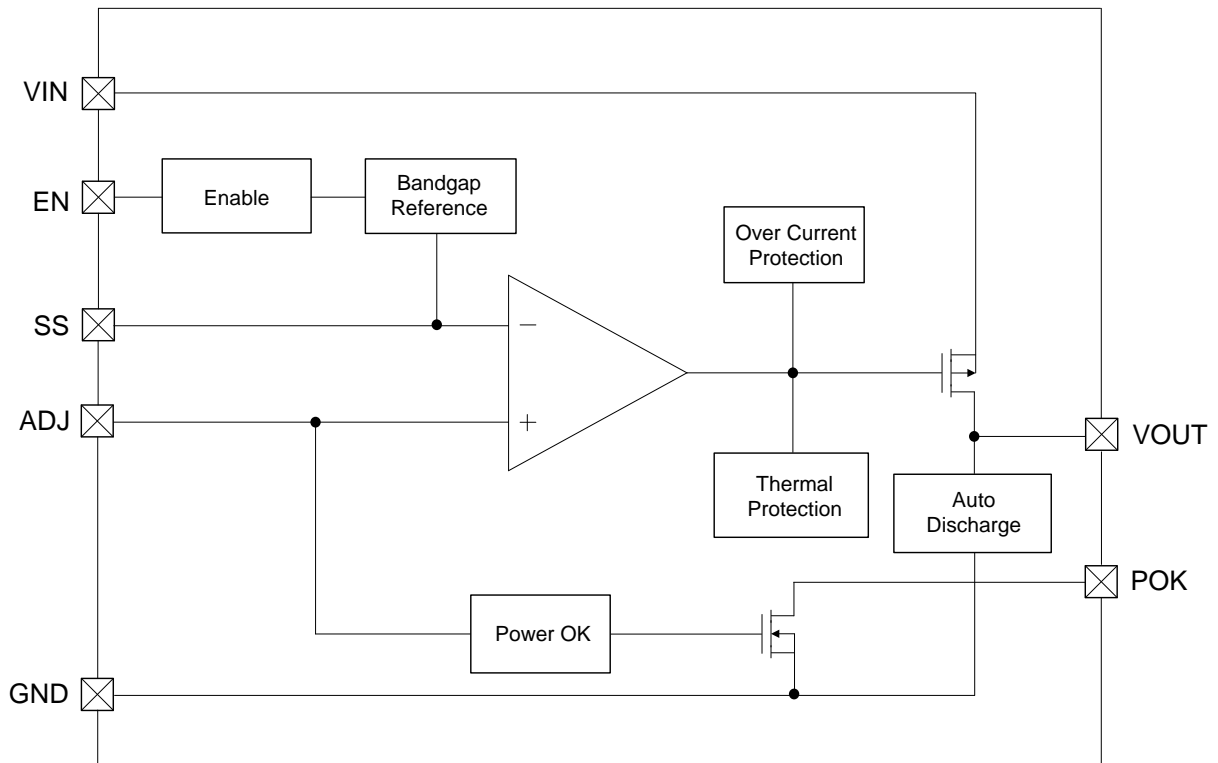

## TYPICAL APPLICATION

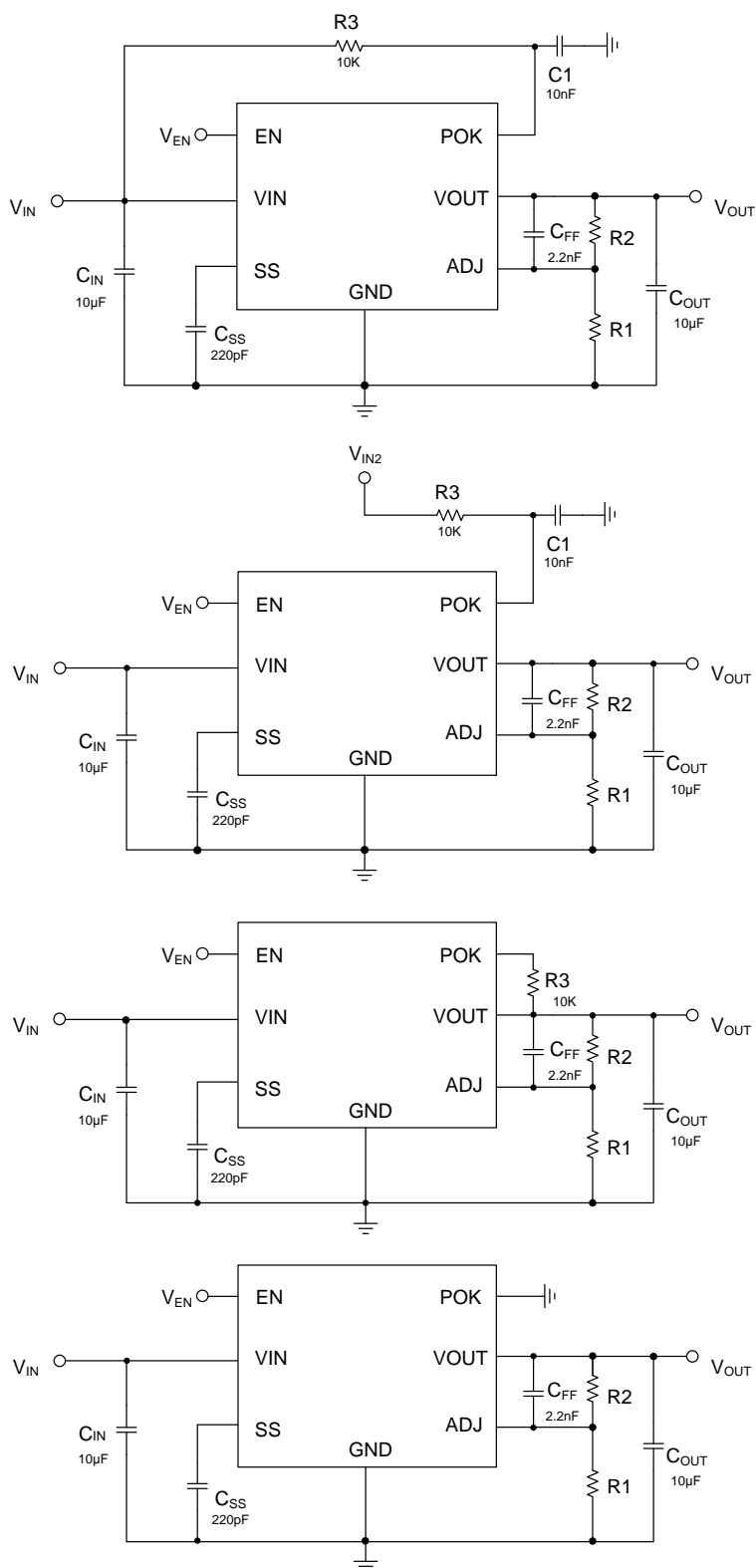

## ELECTRICAL CHARACTERISTICS <sup>(Note 3)</sup>

Limits in standard typeface are for  $T_J=25^{\circ}\text{C}$ , and limits in **boldface type** apply over the **full operating temperature range**.  
 Unless otherwise specified:  $V_{IN}^{(Note\ 4)} = V_{O(NOM)} + 1\text{ V}$ ,  $I_L = 10\text{ mA}$ ,  $C_{IN} = 10\ \mu\text{F}$ ,  $C_{OUT} = 10\ \mu\text{F}$ ,  $V_{EN} = V_{IN} - 0.3\text{ V}$

PARAMETER	SYMBOL	TEST CONDITION	MIN.	TYP.	MAX.	UNIT	
Output Voltage Tolerance	$V_O$	$V_{OUT}+1\text{ V} < V_{IN} < 5.5\text{ V}$	-2 -3	0	2 3	%	
Adjustable Pin Voltage (ADJ version)	$V_{ADJ}$	$2.5\text{ V} < V_{IN} < 5.5\text{ V}$	0.588 <b>0.582</b>	0.6	0.612 <b>0.618</b>	V	
Line Regulation <sup>(Note 5)</sup>	$\Delta V_{LINE}$	$V_{OUT}+1\text{ V} < V_{IN} < 5.5\text{ V}$	-	0.25	-	%/V	
Load Regulation <sup>(Note 5, 6)</sup>	$\Delta V_{LOAD}$	$10\text{ mA} < I_L < 1\text{ A}$	-	0.10	-	%	
Dropout Voltage <sup>(Note 7)</sup>	$V_{DROP}$	$I_L = 100\text{ mA}$	-	40	50 <b>60</b>	mV	
		$I_L = 1\text{ A}$	-	350	450 <b>550</b>		
Ground Pin Current <sup>(Note 8)</sup>	$I_{GND}$	$I_L = 100\text{ mA}$	-	0.15	0.20 <b>0.30</b>	mA	
		$I_L = 1\text{ A}$	-	0.20	0.30 <b>0.40</b>		
Ground Pin Current <sup>(Note 9)</sup>	$I_{GND\_OFF}$	$V_{EN} < 0.2\text{ V}$ , POK=Open	-	0.1	- <b>1</b>	$\mu\text{A}$	
Power Supply Rejection Ratio	PSRR	$f = 1\text{ kHz}$	-	45	-	dB	
		$f = 1\text{ kHz}$ , $C_{FF} = 1\ \mu\text{F}$	-	60	-		
Thermal Shutdown Temperature	$T_{SD}$	-	-	165	-	$^{\circ}\text{C}$	
Thermal Shutdown Hysteresis	$\Delta T_{SD}$	-	-	20	-	$^{\circ}\text{C}$	
OCP Threshold Level	$I_{OCP}$	-	-	1.8	-	A	
Power OK Threshold	$V_{POKTH}$	-	-	92	-	%	
Power OK Hysteresis	$V_{POKHYS}$	-	-	7	-	%	
Auto Discharge Resistance	$R_{DS}$	$V_{IN} = 5\text{V}$ , $V_{EN} = 0\text{V}$	-	330	-	$\Omega$	
Enable threshold	Logic Low	$V_{IL}$	Output = Low	-	-	0.4	V
	Logic High	$V_{IH}$	Output = High	2.0	-	-	V
Enable Input Current	$I_{EN}$	$V_{EN} = V_{IN}$	-	0.1	- <b>1</b>	$\mu\text{A}$	

Note 1. Exceeding the absolute maximum ratings may damage the device.

Note 2. The device is not guaranteed to function outside its operating ratings.

Note 3. Stresses listed as the absolute maximum ratings may cause permanent damage to the device. These are for stress ratings. Functional operating of the device at these or any other conditions beyond those indicated in the operational sections of the specifications is not implied. Exposure to absolute maximum rating conditions for extended periods may remain possibly to affect device reliability.

Note 4. The minimum operating value for input voltage is equal to either  $(V_{OUT,NOM} + V_{DROP})$  or 2.5V, whichever is greater.

Note 5. Output voltage line regulation is defined as the change in output voltage from the nominal value due to change in the input line voltage. Output voltage load regulation is defined as the change in output voltage from the nominal value due to change in load current.

Note 6. Regulation is measured at constant junction temperature by using a 10ms current pulse. Devices are tested for load regulation in the load range from 10mA to 1A.

Note 7. Dropout voltage is defined as the minimum input to output differential voltage at which the output drops 2% below the nominal value. Dropout voltage specification applies only to output voltages of 2.5V and above. For output voltages below 2.5V, the dropout voltage is nothing but the input to output differential, since the minimum input voltage is 2.5V

Note 8. Ground current, or quiescent current, is the difference between input and output currents. It's defined by  $I_{GND1} = I_{IN} - I_{OUT}$  under the given loading condition. The total current drawn from the supply is the sum of the load current plus the ground pin current.

Note 9. Ground current, or standby current, is the input current drawn by a regulator when the output voltage is disabled by an enable signal.

## APPLICATION INFORMATION

### Introduction

TJ4310 is intended for applications where high current capability and very low dropout voltage are required. It provides a simple, low cost solution that occupies very little PCB estate. Additional features include an enable pin to allow for a very low power consumption standby mode, an adjustable pin to provide a fully adjustable output voltage.

### Component Selection

#### Input Capacitor

A large bulk capacitance over than  $10\mu\text{F}$  should be closely placed to the input supply pin of the TJ4310 to ensure that the input supply voltage does not sag. Also a minimum of  $10\mu\text{F}$  ceramic capacitor is recommended to be placed directly next to the VIN Pin. It allows for the device being some distance from any bulk capacitor on the rail. Additionally, input droop due to load transients is reduced, improving load transient response. Additional capacitance may be added if required by the application.(See Fig.1)

#### Output Capacitor

A minimum ceramic capacitor over than  $10\mu\text{F}$  should be very closely placed to the output voltage pin of the TJ4310. Increasing capacitance will improve the overall transient response and stability. When applying an output capacitor that has big capacitance, the soft start time using soft start capacitor at SS pin should be carefully adjusted to avoid any in-rush current problem.

#### Decoupling (Bypass) Capacitor

In very electrically noisy environments, it is recommended that additional ceramic capacitors be placed from VIN to GND. The use of multiple lower value ceramic capacitors in parallel with output capacitor also allows to achieve better transient performance and stability if required by the application.(See Fig.1)

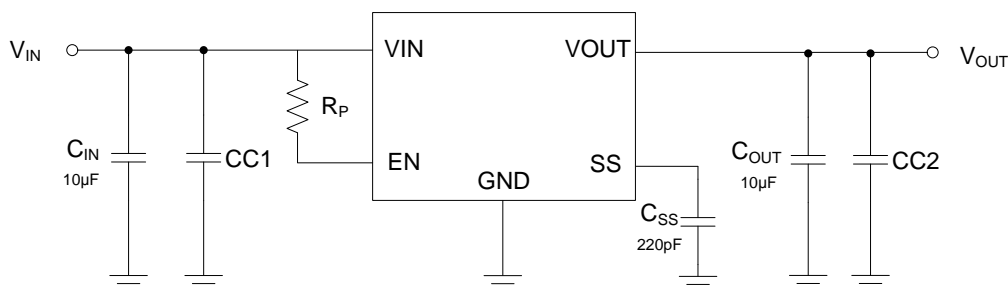

Fig. 1. Application with Decoupling Capacitor, CC1 & CC2

#### Feed-Forward Capacitor

To get the higher PSRR than the inherent performance of TJ4310, it is recommended that additional ceramic feed-forward capacitor be placed from VOUT pin to ADJ pin. The capacitance of feed-forward capacitor with range of 2.2nF to  $1\mu\text{F}$  allows to achieve better PSRR performance when required by the application.(See

Fig.2)

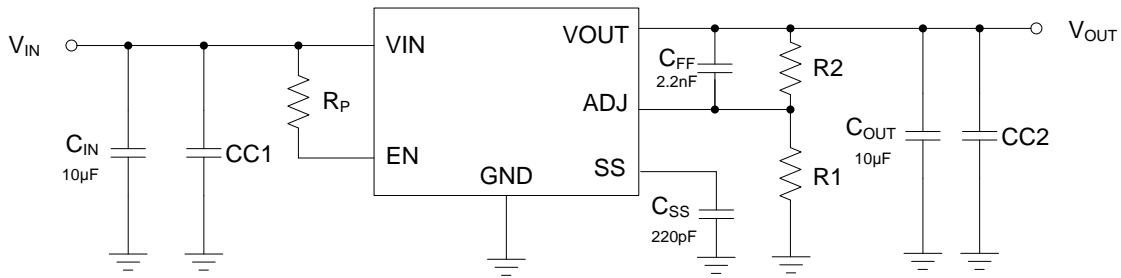

Fig. 2. Application with Feed-Forward Capacitor, CFF

**Delayed Start-Up**

When power sequence control is required or rising time of input supply voltage is over than 100µsec, it is recommended to apply delayed start-up by using Cdelay as shown in Fig. 3. It can adjust proper delay by Rp-Cdelay time constant. And also it can prevent any unexpected transient characteristics at output voltage when the rising time of input supply voltage is as long as 100µsec or longer.

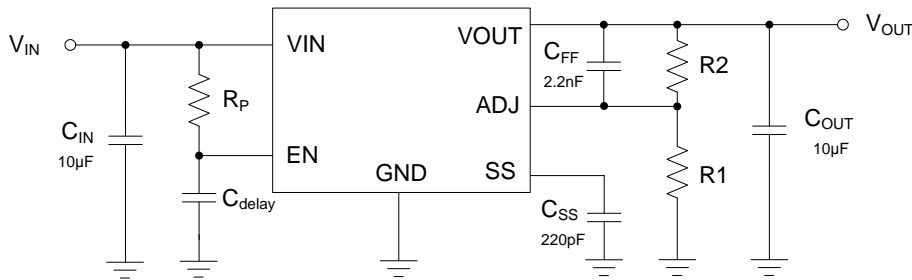

Fig. 3. Application with Delayed Start-Up

**Output Adjustment (Adjustable Version)**

An adjustable output device has output voltage range of 1.0V to 4.5V. The operating condition of VIN and the operating characteristics of VOUT depend on the dropout voltage performance in accordance with output load current. To obtain a desired output voltage, the following equation can be used with R1 resistor range of 1kΩ to 100kΩ.

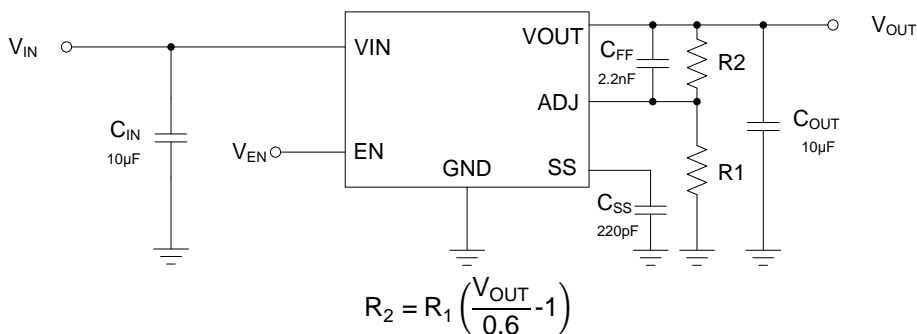

Fig. 4. Application for Adjustable Output Voltage

To enhance output stability, a feed-forward capacitor of 2.2nF to 1µF can be placed in series with VOUT and ADJ.(Refer to "Component Selection" Section)



## Soft Start Time

The TJ4310 has an internal current source that charges an external slow start capacitor to implement a slow start time. Equation and Table 1 shows how to select a slow start capacitor based on an expected slow start time. The R is 450kΩ, V<sub>O</sub> is 0.6V and i(t) is 130nA. Adjustment of soft start time using SS pin capacitor is help to suppress unexpected abnormal in-rush current that can cause device failure.

$$T_{SS}(s) = -RC_{SS} \times \ln \frac{i(t)R}{V_o}$$

C <sub>SS</sub>	Calculated Soft-Start Time
220pF	0.23ms
470pF	0.49ms
1nF	1.04ms
2.7nF	2.82ms
5.6nF	5.86ms
10nF	10.4ms

Table 1. Capacitor Values for the soft-start time

## Auto Discharge Function

The TJ4310 provides an auto discharge function that is used for faster discharging of the output capacitor. This function is automatically activated when the EN input goes into an active low state.

## Maximum Output Current Capability

The TJ4310 can deliver a continuous current of 1A over the full operating junction temperature range. However, the output current is limited by the restriction of power dissipation which differs from packages. A heat sink may be required depending on the maximum power dissipation and maximum ambient temperature of application. With respect to the applied package, the maximum output current of 1A may be still undeliverable due to the restriction of the power dissipation of TJ4310. Under all possible conditions, the junction temperature must be within the range specified under operating conditions.

The temperatures over the device are given by:

$$\begin{aligned} T_C &= T_A + P_D \times \theta_{CA} \\ T_J &= T_C + P_D \times \theta_{JC} \\ T_J &= T_A + P_D \times \theta_{JA} \end{aligned}$$

where T<sub>J</sub> is the junction temperature, T<sub>C</sub> is the case temperature, T<sub>A</sub> is the ambient temperature, P<sub>D</sub> is the total power dissipation of the device, θ<sub>CA</sub> is the thermal resistance of case-to-ambient, θ<sub>JC</sub> is the thermal resistance of junction-to-case, and θ<sub>JA</sub> is the thermal resistance of junction to ambient.

The total power dissipation of the device is given by:

$$\begin{aligned} P_D &= P_{IN} - P_{OUT} = (V_{IN} \times I_{IN}) - (V_{OUT} \times I_{OUT}) \\ &= (V_{IN} \times (I_{OUT} + I_{GND})) - (V_{OUT} \times I_{OUT}) = (V_{IN} - V_{OUT}) \times I_{OUT} + V_{IN} \times I_{GND} \end{aligned}$$

where I<sub>GND</sub> is the operating ground current of the device which is specified at the Electrical Characteristics. The maximum allowable temperature rise (T<sub>Rmax</sub>) depends on the maximum ambient temperature (T<sub>Amax</sub>) of the application, and the maximum allowable junction temperature (T<sub>Jmax</sub>):

$$T_{Rmax} = T_{Jmax} - T_{Amax}$$

The maximum allowable value for junction-to-ambient thermal resistance,  $\theta_{JA}$ , can be calculated using the formula:

$$\theta_{JA} = T_{Rmax} / P_D$$

TJ4310 is available in SOP8, SOP8-PP, SOT-89-5L, DFN2X3-8L packages. The thermal resistance depends on amount of copper area or heat sink, and on air flow.

If proper cooling solution such as heat sink, copper plane area, or air flow is applied, the maximum allowable power dissipation could be increased. However, if the ambient temperature is increased, the allowable power dissipation would be decreased.

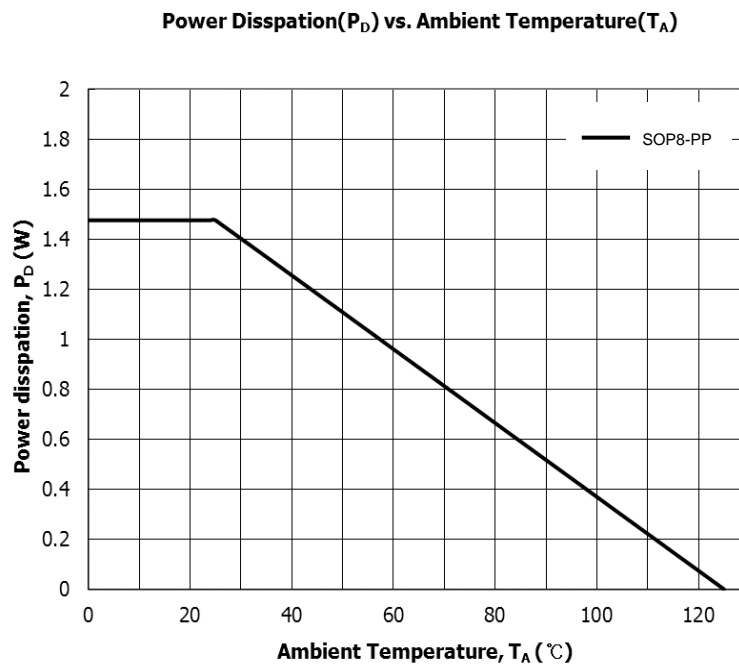

The graph above is valid for the thermal impedance specified in the Absolute Maximum Ratings section on page 1.

The  $\theta_{JA}$  could be decreased with respect to the copper plane area. So, the specification of maximum power dissipation for an application is fixed, the proper plane area could be estimated by following graphs. Wider copper plane area leads lower  $\theta_{JA}$ .

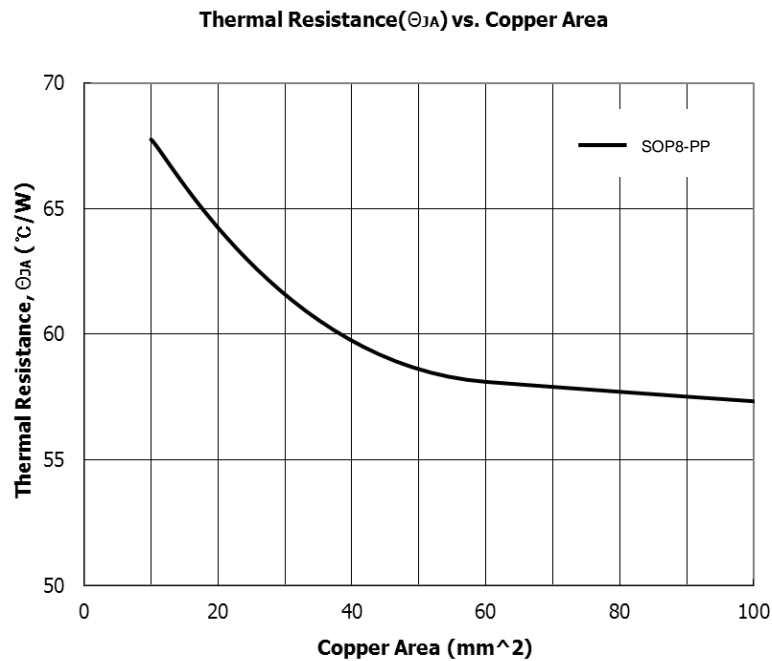

The maximum allowable power dissipation is also influenced by the ambient temperature. With the  $\theta_{JA}$ -Copper plane area relationship, the maximum allowable power dissipation could be evaluated with respect to the ambient temperature. As shown in graph, the higher copper plane area leads  $\theta_{JA}$ . And the higher ambient temperature leads lower maximum allowable power dissipation.

## TYPICAL OPERATING CHARACTERISTICS

### Test Circuit

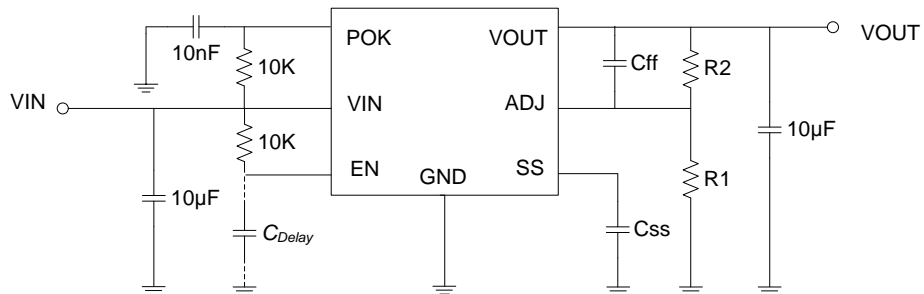

**VOUT = 1.2V ( VIN = 2.5V, R1 = 10KΩ, R2 = 10KΩ )**

VOUT = 1.2V ( C<sub>css</sub> = 220pF, C<sub>ff</sub> = 2.2nF )

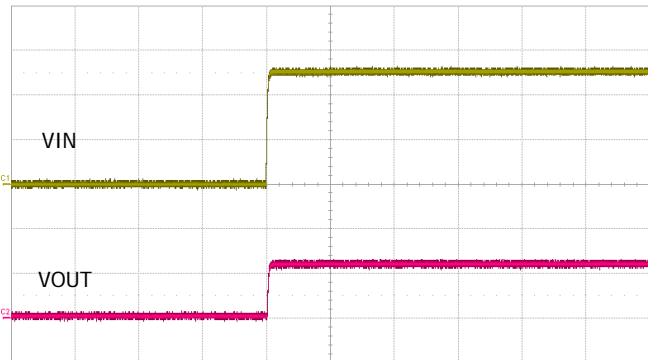

VIN : 1.0V/div, VOUT : 1.0V/div, Time : 10ms/div

Start Up @ Iout=0A

VOUT = 1.2V ( C<sub>css</sub> = 220pF, C<sub>ff</sub> = 2.2nF )

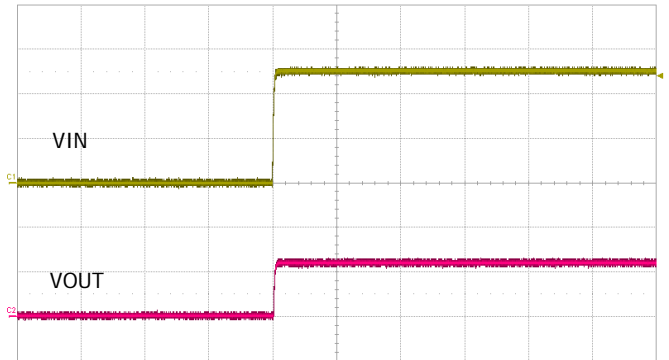

VIN : 1.0V/div, VOUT : 1.0V/div, Time : 10ms/div

Start Up @ Iout=1A

VOUT = 1.2V ( C<sub>css</sub> = 220pF, C<sub>ff</sub> = 10nF )

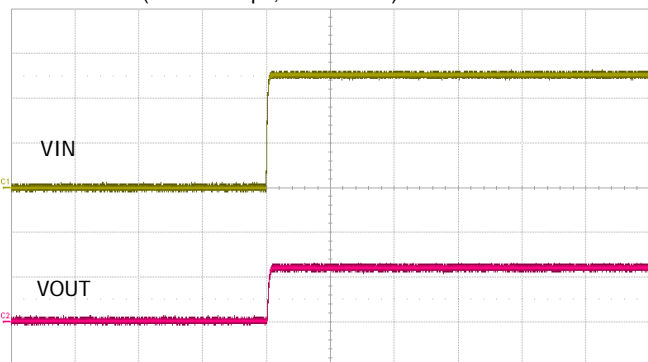

VIN : 1.0V/div, VOUT : 1.0V/div, Time : 10ms/div

Start Up @ Iout=0A

VOUT = 1.2V ( C<sub>css</sub> = 220pF, C<sub>ff</sub> = 10nF )

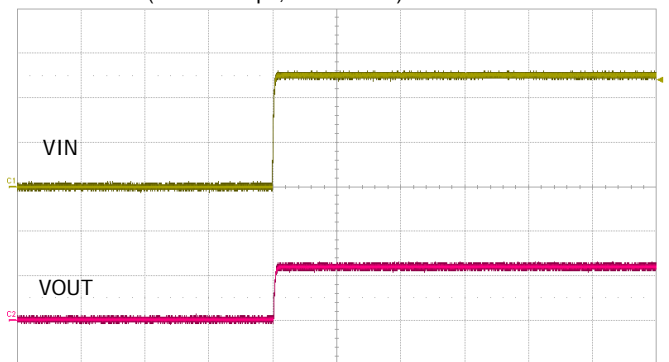

VIN : 1.0V/div, VOUT : 1.0V/div, Time : 10ms/div

Start Up @ Iout=1A

VOUT = 1.2V ( C<sub>ss</sub> = 220pF, C<sub>f</sub> = 1 $\mu$ F )

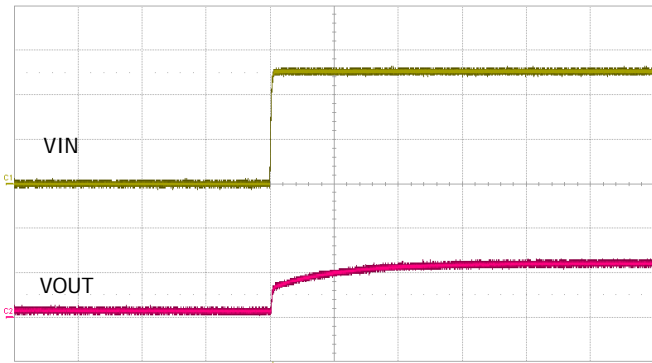

VIN : 1.0V/div, VOUT : 1.0V/div, Time : 10ms/div

Start Up @ I<sub>out</sub>=0A

VOUT = 1.2V ( C<sub>ss</sub> = 220pF, C<sub>f</sub> = 1 $\mu$ F )

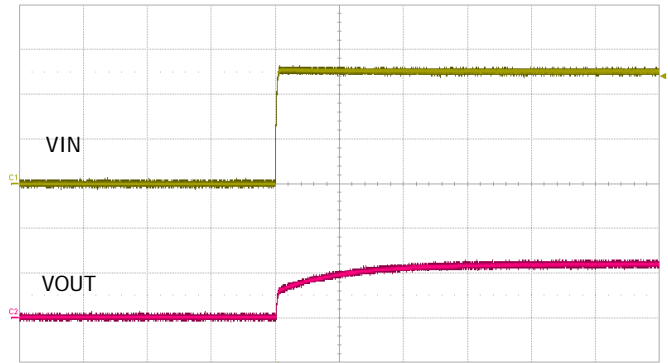

VIN : 1.0V/div, VOUT : 1.0V/div, Time : 10ms/div

Start Up @ I<sub>out</sub>=1A

VOUT = 1.2V ( C<sub>f</sub> = 10nF )

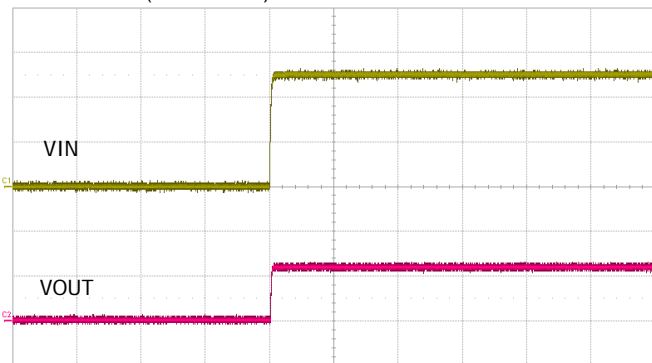

VIN : 1.0V/div, VOUT : 1.0V/div, Time : 10ms/div

Start Up @ I<sub>out</sub>=0A

VOUT = 1.2V ( C<sub>f</sub> = 10nF )

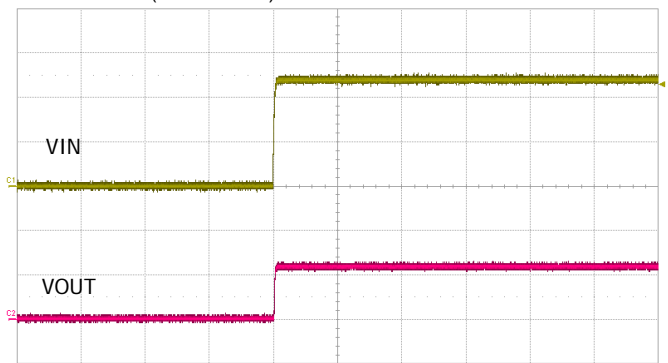

VIN : 1.0V/div, VOUT : 1.0V/div, Time : 10ms/div

Start Up @ I<sub>out</sub>=1A

VOUT = 1.2V ( C<sub>f</sub> = 1 $\mu$ F )

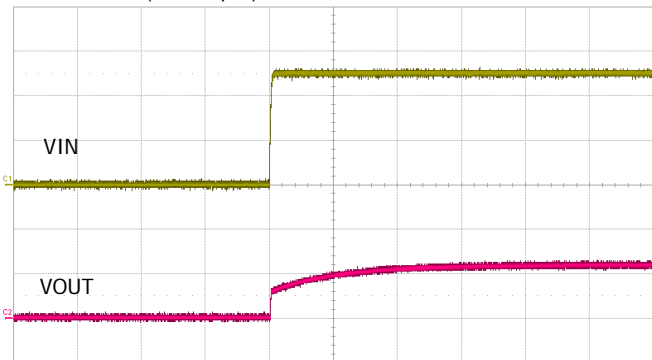

VIN : 1.0V/div, VOUT : 1.0V/div, Time : 10ms/div

Start Up @ I<sub>out</sub>=0A

VOUT = 1.2V ( C<sub>f</sub> = 1 $\mu$ F )

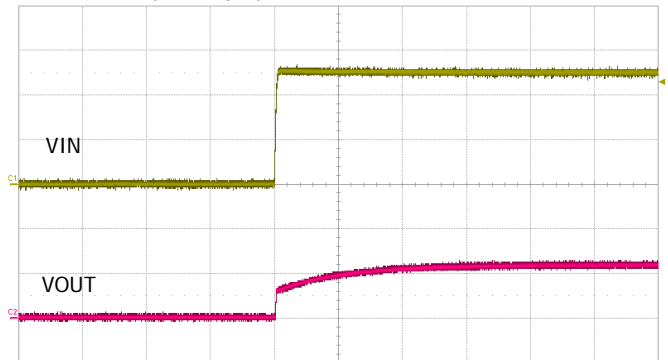

VIN : 1.0V/div, VOUT : 1.0V/div, Time : 10ms/div

Start Up @ I<sub>out</sub>=1A

VOUT = 1.2V ( C<sub>ss</sub> = 220pF, C<sub>ff</sub> = 2.2nF )

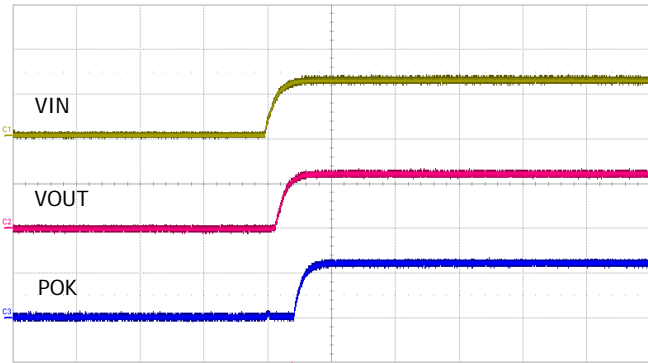

VIN : 2.0V/div, VOUT : 1.0V/div, POK : 2.0V/div, Time : 1ms/div  
Start Up @ I<sub>out</sub>=1A

VOUT = 1.2V ( C<sub>ss</sub> : varied, C<sub>ff</sub> = 2.2nF )

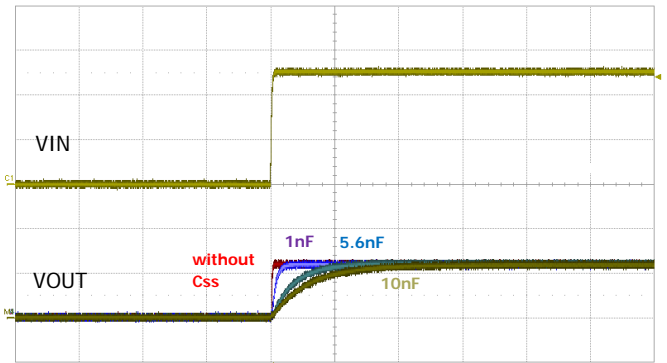

VIN : 1.0V/div, VOUT : 1.0V/div, Time : 10ms/div  
Start Up @ I<sub>out</sub>=10mA

VOUT = 1.2V ( C<sub>ff</sub> : varied, C<sub>ss</sub> = 220pF )

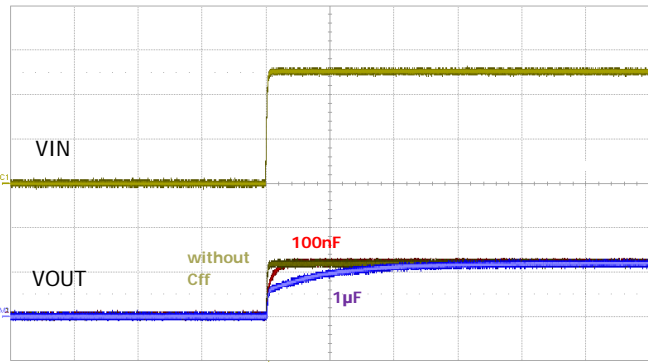

VIN : 1.0V/div, VOUT : 1.0V/div, Time : 10ms/div  
Start Up @ I<sub>out</sub>=10mA

VOUT = 1.2V ( C<sub>ff</sub> : varied )

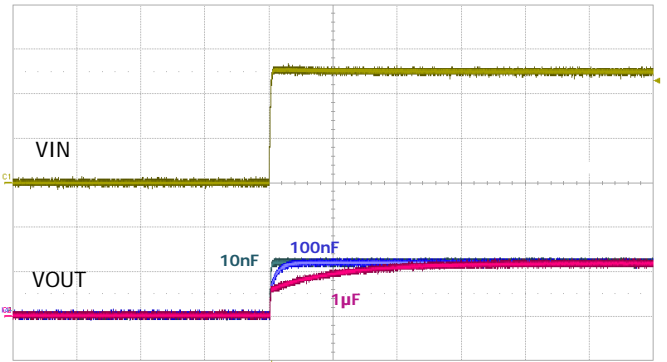

VIN : 1.0V/div, VOUT : 1.0V/div, Time : 10ms/div  
Start Up @ I<sub>out</sub>=10mA

VOUT = 1.2V ( C<sub>delay</sub> : varied, C<sub>ss</sub> = 220pF, C<sub>ff</sub> = 2.2nF )

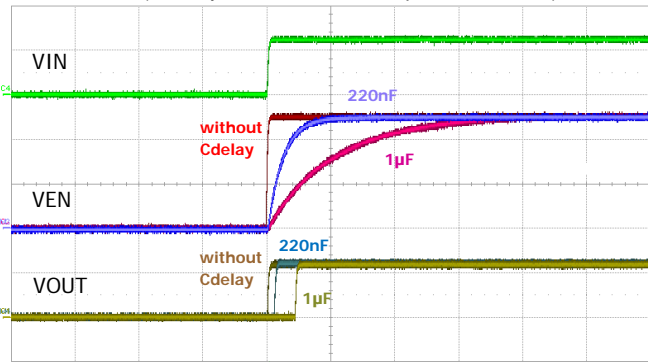

VIN : 2.0V/div, VEN : 1.0V/div, VOUT : 1.0V/div, Time : 10ms/div  
Start Up with C<sub>delay</sub> @ I<sub>out</sub>=10mA

VOUT = 1.2V ( C<sub>delay</sub> : varied, C<sub>ff</sub> = 10nF )

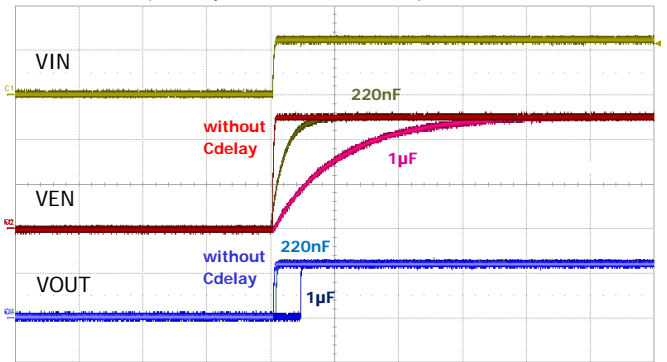

VIN : 2.0V/div, VEN : 1.0V/div, VOUT : 1.0V/div, Time : 10ms/div  
Start Up with C<sub>delay</sub> @ I<sub>out</sub>=10mA

VOUT = 1.2V ( C<sub>SS</sub> = 220pF, C<sub>F</sub> = 2.2nF )

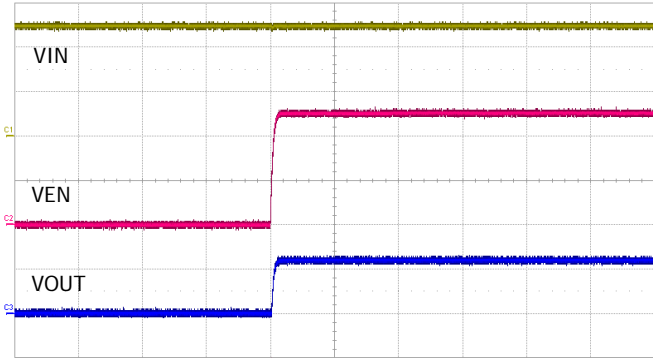

VIN : 1.0V/div, VEN : 1.0V/div, VOUT : 1.0V/div, Time : 5ms/div  
Start Up by External VEN @ I<sub>out</sub>=0A

VOUT = 1.2V ( C<sub>SS</sub> = 220pF, C<sub>F</sub> = 2.2nF )

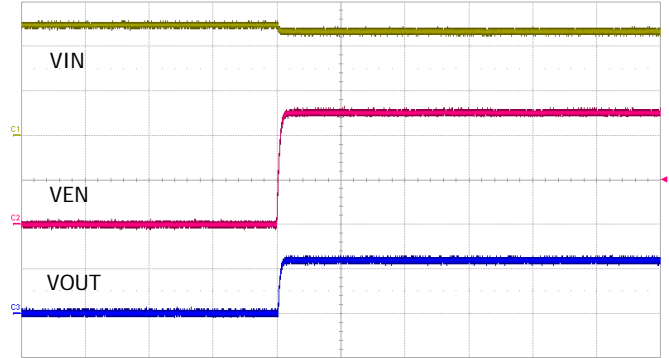

VIN : 1.0V/div, VEN : 1.0V/div, VOUT : 1.0V/div, Time : 5ms/div  
Start Up by External VEN @ I<sub>out</sub>=1A

VOUT = 1.2V ( C<sub>F</sub> = 10nF )

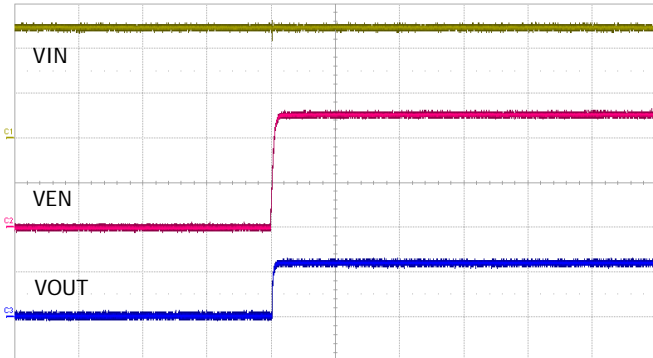

VIN : 1.0V/div, VEN : 1.0V/div, VOUT : 1.0V/div, Time : 5ms/div  
Start Up by External VEN @ I<sub>out</sub>=0A

VOUT = 1.2V ( C<sub>F</sub> = 10nF )

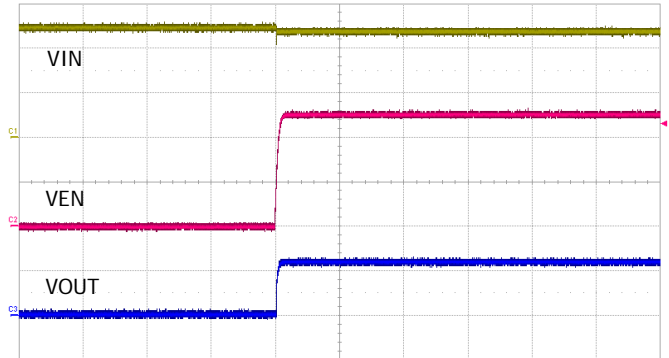

VIN : 1.0V/div, VEN : 1.0V/div, VOUT : 1.0V/div, Time : 5ms/div  
Start Up by External VEN @ I<sub>out</sub>=1A

VOUT = 1.2V ( C<sub>SS</sub> = 220pF, C<sub>F</sub> = 2.2nF )

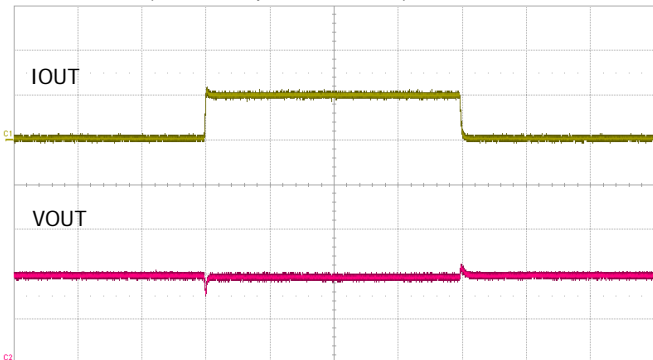

IOUT : 1.0A/div, VOUT : 100mV/div, Time : 500μs/div  
Load Transient Response

VOUT = 1.2V ( C<sub>F</sub> = 10nF )

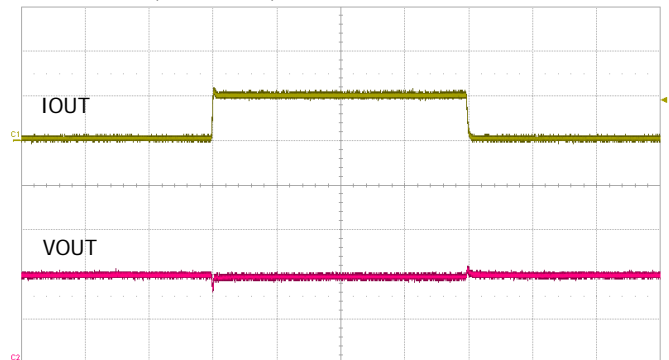

IOUT : 1.0A/div, VOUT : 100mV/div, Time : 500μs/div  
Load Transient Response

VOUT = 3.3V ( VIN = 4.3V, R1 = 10KΩ, R2 = 45KΩ )

VOUT = 3.3V ( C<sub>SS</sub> = 220pF, C<sub>F</sub> = 2.2nF )

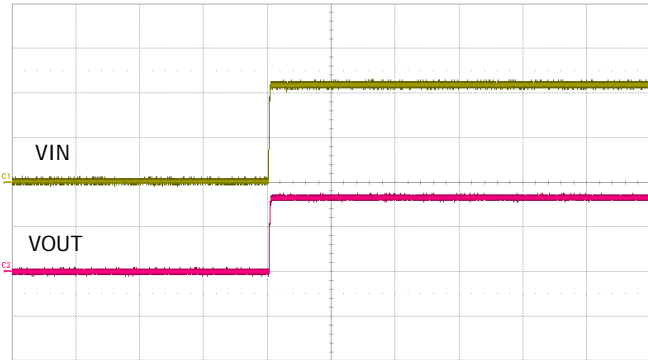

Start Up @ Iout=0A

VOUT = 3.3V ( C<sub>SS</sub> = 220pF, C<sub>F</sub> = 2.2nF )

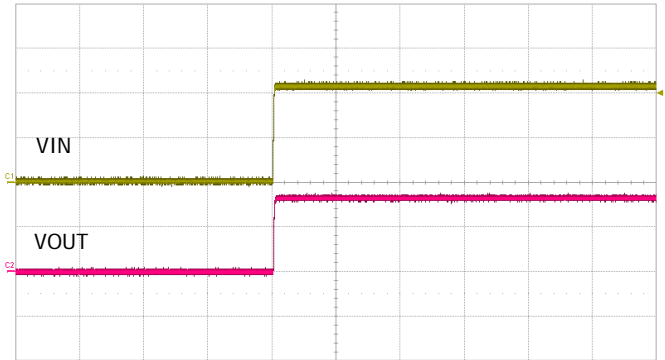

Start Up @ Iout=1A

VOUT = 3.3V ( C<sub>SS</sub> = 220pF, C<sub>F</sub> = 10nF )

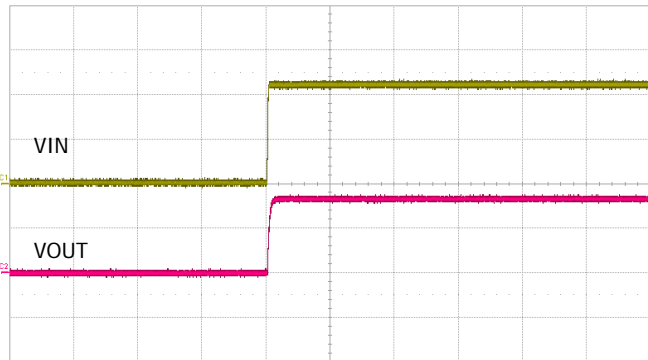

Start Up @ Iout=0A

VOUT = 3.3V ( C<sub>SS</sub> = 220pF, C<sub>F</sub> = 10nF )

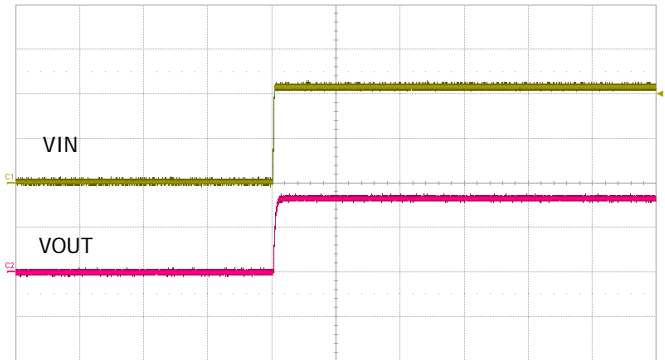

Start Up @ Iout=1A

VOUT = 3.3V ( C<sub>SS</sub> = 220pF, C<sub>F</sub> = 1μF )

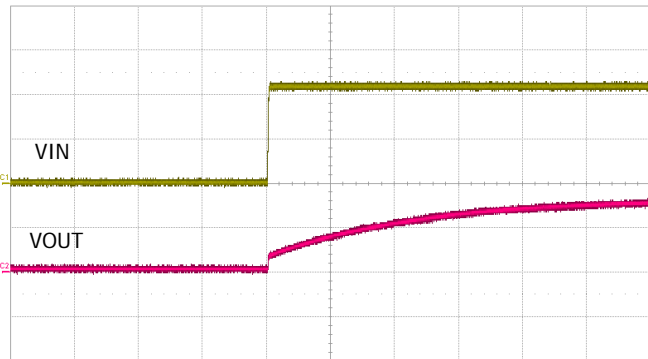

Start Up @ Iout=0A

VOUT = 3.3V ( C<sub>SS</sub> = 220pF, C<sub>F</sub> = 1μF )

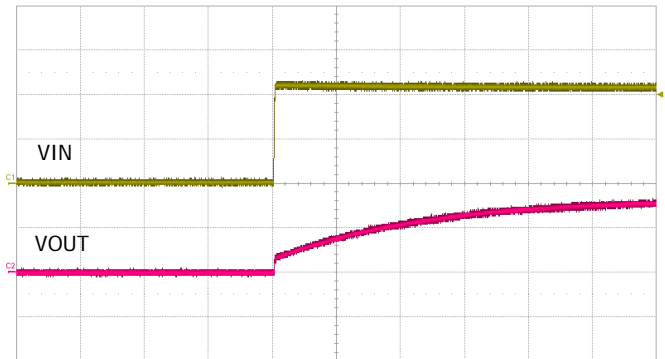

Start Up @ Iout=1A



VOUT = 3.3V ( Cff = 10nF )

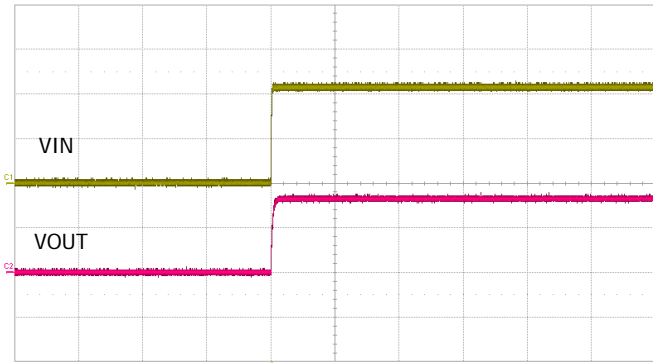

VIN : 2.0V/div, VOUT : 2.0V/div, Time : 20ms/div

Start Up @ Iout=0A

VOUT = 3.3V ( Cff = 10nF )

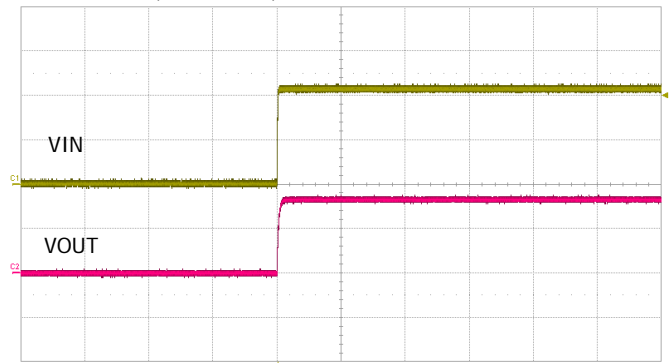

VIN : 2.0V/div, VOUT : 2.0V/div, Time : 20ms/div

Start Up @ Iout=1A

VOUT = 3.3V ( Cff = 1μF )

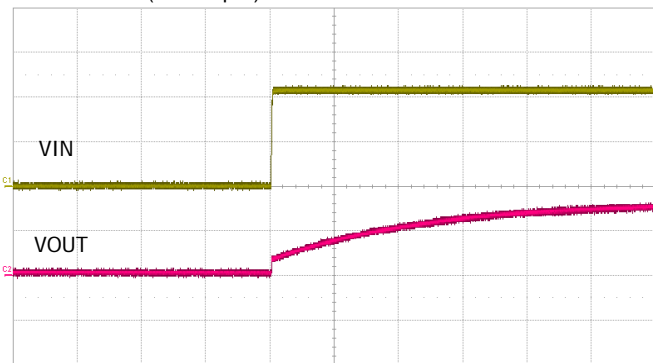

VIN : 2.0V/div, VOUT : 2.0V/div, Time : 20ms/div

Start Up @ Iout=0A

VOUT = 3.3V ( Cff = 1μF )

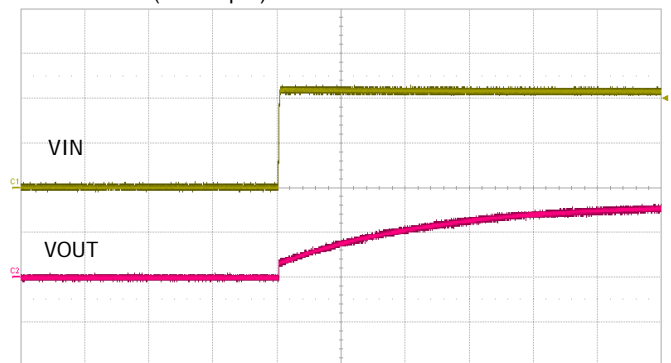

VIN : 2.0V/div, VOUT : 2.0V/div, Time : 20ms/div

Start Up @ Iout=1A

VOUT = 3.3V ( Ccss = 220pF, Cff = 2.2nF )

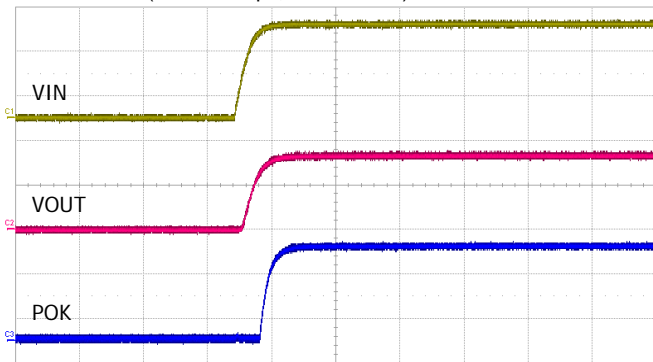

VIN : 2.0V/div, VOUT : 2.0V/div, POK : 2.0V/div, Time : 1ms/div

Start Up @ Iout=1A

VOUT = 3.3V ( Ccss : varied, Cff = 2.2nF )

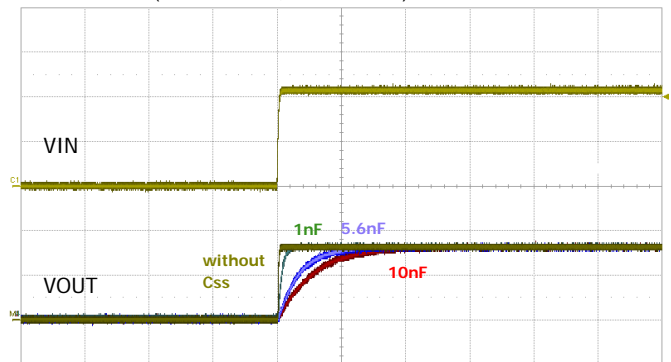

VIN : 2.0V/div, VOUT : 2.0V/div, Time : 10ms/div

Start Up @ Iout=10mA

VOUT = 3.3V ( Cff : varied, C<sub>ss</sub> = 220pF )

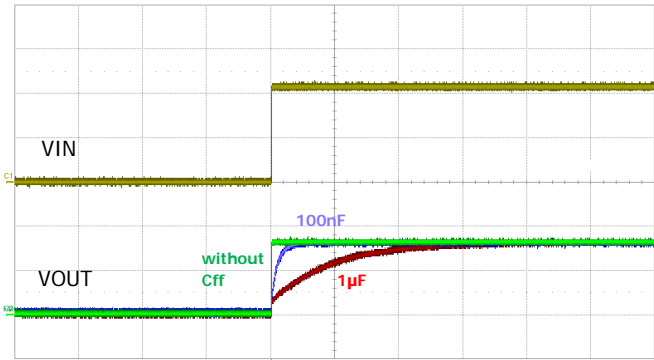

VIN : 2.0V/div, VOUT : 2.0V/div, Time : 50ms/div  
Start Up @ I<sub>out</sub>=10mA

VOUT = 3.3V ( Cff : varied )

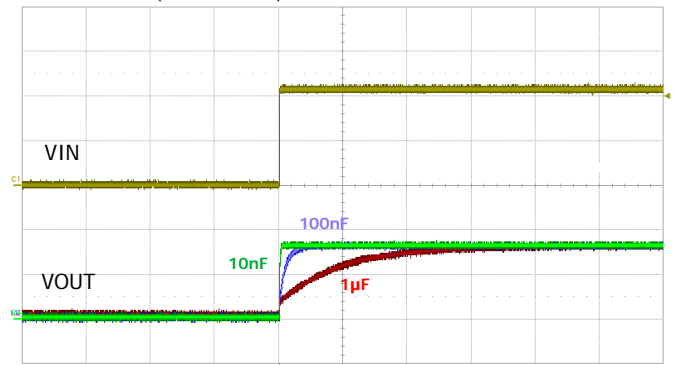

VIN : 2.0V/div, VOUT : 2.0V/div, Time : 50ms/div  
Start Up @ I<sub>out</sub>=10mA

VOUT = 3.3V ( Cdelay : varied, C<sub>ss</sub> = 220pF, Cff = 2.2nF )

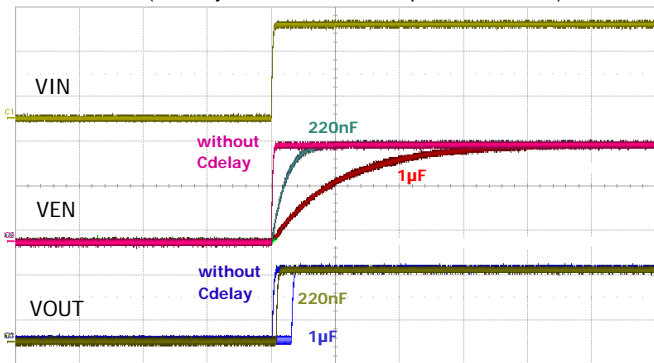

VIN : 2.0V/div, VEN : 2.0V/div, VOUT : 2.0V/div, Time : 10ms/div  
Start Up with Cdelay @ I<sub>out</sub>=10mA

VOUT = 3.3V ( Cdelay : varied, Cff = 10nF )

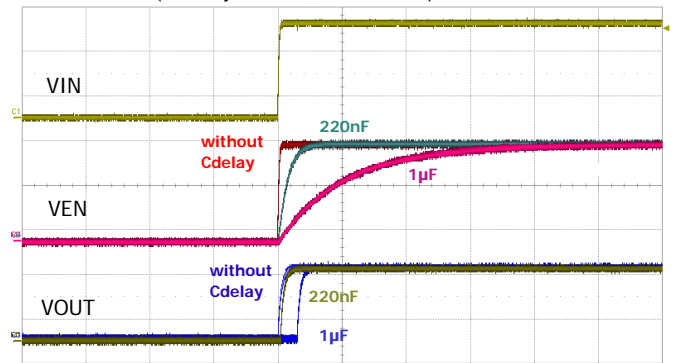

VIN : 2.0V/div, VEN : 2.0V/div, VOUT : 2.0V/div, Time : 10ms/div  
Start Up with Cdelay @ I<sub>out</sub>=10mA

VOUT = 3.3V ( C<sub>ss</sub> = 220pF, Cff = 2.2nF )

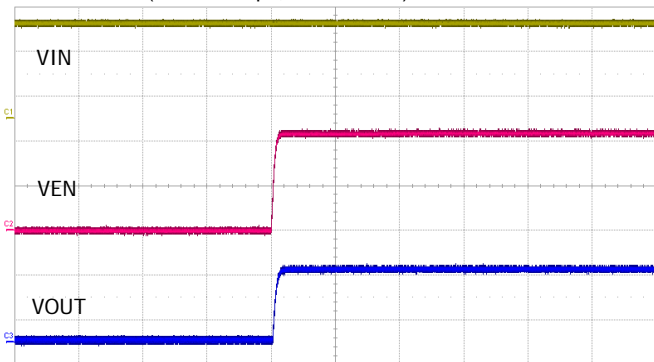

VIN : 2.0V/div, VEN : 2.0V/div, VOUT : 2.0V/div, Time : 5ms/div  
Start Up by External VEN @ I<sub>out</sub>=0A

VOUT = 3.3V ( C<sub>ss</sub> = 220pF, Cff = 2.2nF )

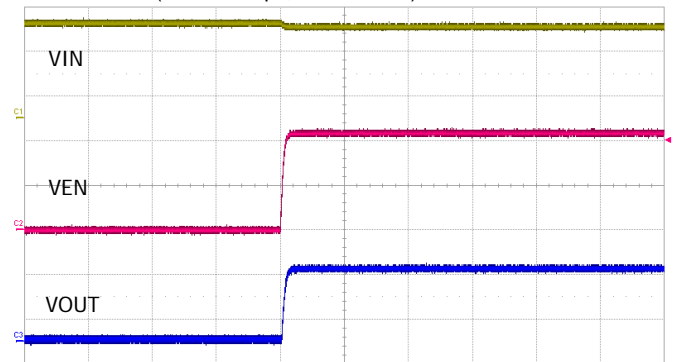

VIN : 2.0V/div, VEN : 2.0V/div, VOUT : 2.0V/div, Time : 5ms/div  
Start Up by External VEN @ I<sub>out</sub>=1A

VOUT = 3.3V ( Cff = 10nF )

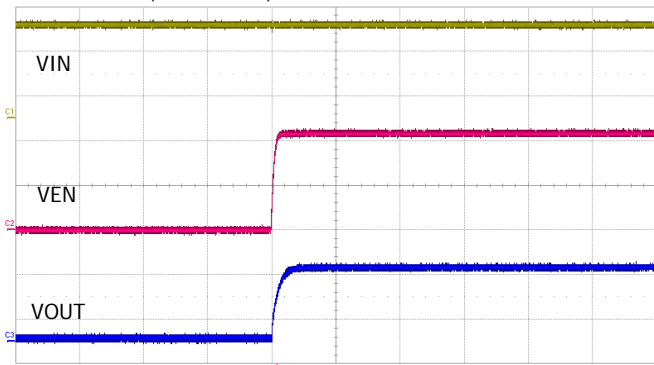

VIN : 2.0V/div, VEN : 2.0V/div, VOUT : 2.0V/div, Time : 5ms/div

Start Up by External VEN @ Iout=0A

VOUT = 3.3V ( Cff = 10nF )

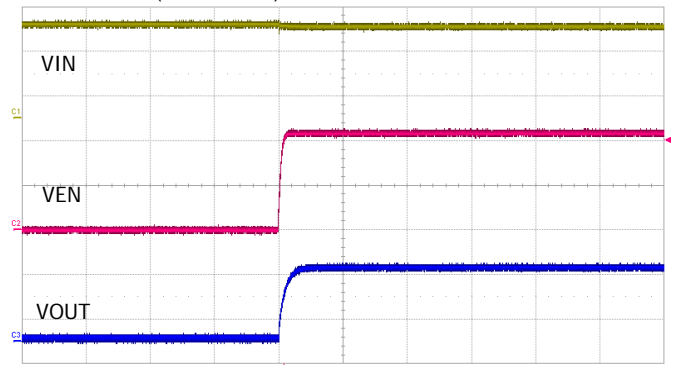

VIN : 2.0V/div, VEN : 2.0V/div, VOUT : 2.0V/div, Time : 5ms/div

Start Up by External VEN @ Iout=1A

VOUT = 3.3V ( Ccss = 220pF, Cff = 2.2nF )

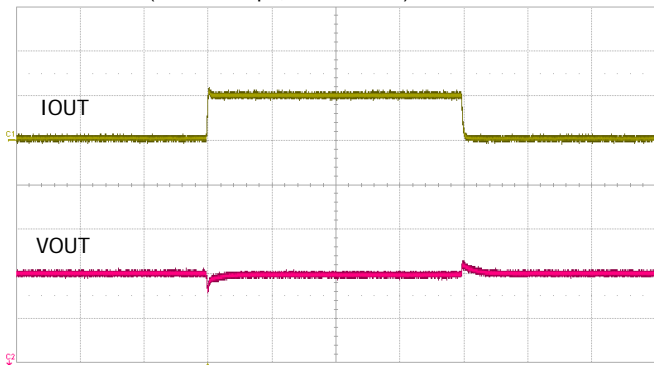

IOUT : 1.0A/div, VOUT : 100mV/div, Time : 500µs/div

Load Transient Response

VOUT = 3.3V ( Cff = 10nF )

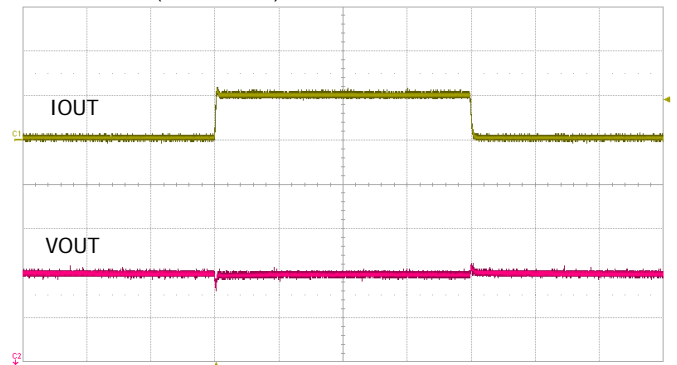

IOUT : 1.0A/div, VOUT : 100mV/div, Time : 500µs/div

Load Transient Response

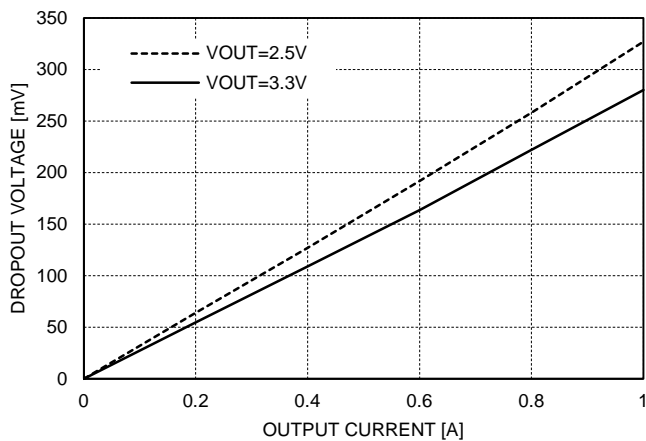

Dropout Voltage

## REVISION NOTICE

The description in this datasheet is subject to change without any notice to describe its electrical characteristics properly.