

IC DATA SHEET



LDO REGULATOR WITH ON/OFF SWITCH
TK112xxC

Features

- Very low Dropout Voltage. ($V_{drop}=105mV$ at 100mA)
- Very good stability ($C_L=0.1\mu F$ is stable for any type capacitor with $2.5V \leq V_{out}$)
- High Precision output Voltage ($\pm 1.5\%$ or $\pm 50mV$)
- Good ripple rejection ratio (80dB at 1KHz)
- Wide operating voltage range (1.8V ~ 14.5V)
- Peak output current is 480mA.(10% down point)
- Built-in Short circuit protection
- Built-in Thermal Shutdown
- Suitable for Very Low Noise Applications
- Built-in on/off Control (0.1 μA Max Standby current) High On
- Very Small Surface Mount Packages SOT23L / SOT89 package
- Built-in reverse bias over current protection

Description

The TK112xxC is an integrated circuit with a silicon monolithic bipolar structure. The regulator is of the low saturation voltage output type with very little quiescent current (65 μA).

The PNP power transistor is built-in. The I/O voltage difference is 0.17V (typical) when a current of 200mA is supplied to the system. Because of the low voltage drop, the voltage source can be effectively used; this makes it very suitable for battery powered equipment.

The on/off function is built into the IC. The current during standby mode becomes very small (pA level).

The output voltage is available from 1.5 to 10.0V in 0.1V steps. The output voltage is trimmed with high accuracy. This allows the optimum voltage to be selected for the equipment.

The over current sensor circuit and the reverse-bias protection circuit are built-in.

It is a very rugged design because the ESD protection is high. Therefore, the TK112xxC can be used with confidence.

When mounted on the PCB, the power dissipation rating becomes about 600mW/ 900mW, even though the packages are very small.

The TK112xxC features very high stability in both DC and AC.

The capacitor on the output side provides stable operation with 0.1 μF with $2.5V \leq V_{out}$. A capacitor of any type can be used; however, the larger this capacitor is, the better the overall characteristics are.

ORDERING INFORMATION

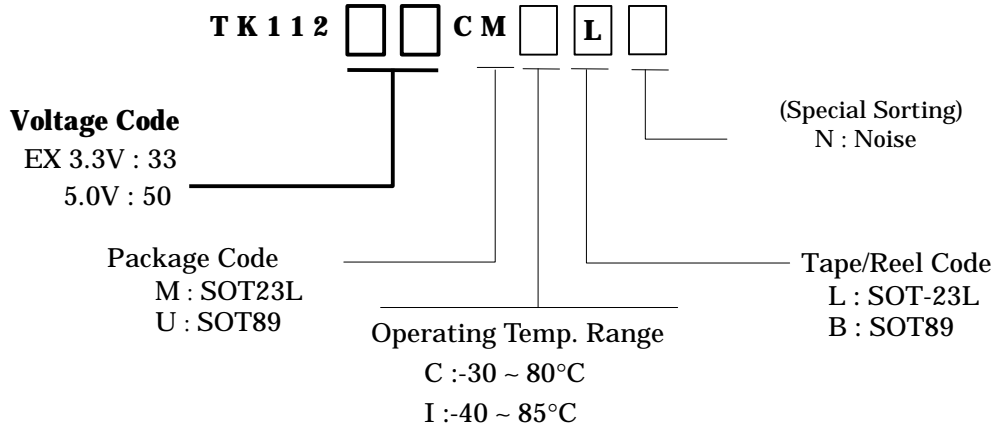

Boldface type applies **Standard Voltage**.

V OUT	V CODE	V OUT	V CODE	V OUT	V CODE	V OUT	V CODE
1.5 v	15	2.5 v	25	3.5 v	35	4.5 v	45
1.6	16	2.6	26	3.6	36	4.6	46
1.7	17	2.7	27	3.7	37	4.7	47
1.8	18	2.8	28	3.8	38	4.8	48
1.9	19	2.9	29	3.9	39	4.9	49
2.0	20	3.0	30	4.0	40	5.0	50
2.1	21	3.1	31	4.1	41		
2.2	22	3.2	32	4.2	42		
2.3	23	3.3	33	4.3	43		
2.4	24	3.4	34	4.4	44		

Please contact your authorized Toko representative for voltage availability

C rank device**Absolute maximum ratings**

Parameters	Symbol	Limiting Values	Unit
Supply voltage	Vcc Max	-0.4 ~ 16	V
Reverse bias	VrMax	-0.4 ~ 6	V
Np pin voltage	VnpMax	-0.4 ~ 5	V
Control pin voltage	VcontMax	-0.4 ~ 16	V
Storage temperature Range	Tstg	-55 ~ 150	°C
Operating voltage range	Vop	1.8 ~ 14.5	V
Operating temperature range	Top	-30 ~ 80	°C
Short circuit current	Ishort	500	mA
Power dissipation	Internally limited	M : 600mW mounted (reference) U : 900mW mounted (reference)	

Electrical characteristics

		Test Condition				Vtest=Vout _{Typ} +1V Vcont=1.8V (Ta=25°C)	
Parameters	Symbol	Min	Typ	Max	Unit	Condition	
Output voltage	Vout	± 1.5% or ± 50mV				Iout = 5mA	
Line regulation	LinReg		0	6	mV	ΔV=5V Vtest=Vout _{Typ} +1V--- Vout _{Typ} +6V	
Load regulation 2.5V ≤ vo ≤ 5.0V	LoaReg		0.5	1.1	%	5mA < Iout < 100mA	
			1.0	2.2	%	5mA < Iout < 200mA	
			1.6	3.7	%	5mA < Iout < 300mA	
1.5V ≤ Vo ≤ 2.4V	LoaReg		0.8	1.8	%	5mA < Iout < 100mA	
			1.5	3.4	%	5mA < Iout < 200mA	
			2.4	5.3	%	5mA < Iout < 300mA	
Dropout voltage	Vdrop		105	170	mV	Iout=100mA	
			170	270	mV	Iout=200mA	
			235	370	mV	Iout=300mA (2.4V ≤ Vout)	
			235	370	mV	Iout=270mA (2.1V ≤ Vout < 2.4V)	
1.5V ≤ Vout ≤ 2.0V : No regulation		Because of VopMin=1.8V					
Maximum output current	IoutMax	380	480		mA	(Vout _{Typ} × 0.9)	
Quiescent current	Iq		65	90	μA	Iout=0mA Excluding Icont	
Standby current	Istandby		0	0.1	μA	Vcc=8V, Vcont ≤ 0.15V Off state	
Ground pin current	Ignd		1.8	3.0	mA	Iout=100mA	
Control terminal Specification (Pull down resistor = 500k) Note 1							
Control current	Icont		5	10	μA	Vcont=1.8V on state	
Control voltage	Vcont	1.6			V	on state	
				0.6	V	off state	
Np terminal Voltage	Vnp	1.28			V		
Vo	Vo/Ta	Typ=35 ppm/°C				Reference Value	
Out put noise	Vno	0.14 ~ 0.25 μV/√ Hz at 1KHz				Reference Value	

Note 1: The input current decreases to the pA level by connecting the control terminal to GND. (Off state). The Pull-down resistor is 500kΩ.

General Note: Limits are guaranteed by production testing or correction techniques using Statistical Quality Control (SQC) methods. Unless otherwise noted. Vtest=Vout_{Typ}+1V ; IL=1mA (Tj=25°C) The operation of -30°C ~ -80°C is guaranteed in the design by a usual inspection.

General Note: Exceeding the "Absolute Maximum Rating " may damage the device

General Note: Connecting a capacitor to the noise bypass pin can decrease the output noise voltage

General Note: Output noise is 0.14-0.25 μV/√ Hz at 1KHz : 23 ~ 75μVrms at BW400-80kHz

General Note: The ripple rejection is 84dB at 400Hz and 80dB at 1kHz.

[CL=1.0μF,Cnp=0.01μF,Vnois=200mV_{RMS},Vin=Vout_{Typ}+1.5v,Iout=10mA]

I Rank**Absolute Maximum Ratings are same as C Rank****Operating Temperature Range** Top= -40 ~ 85°C**Operating Voltage Range** Vop=2.1V ~ 14.5V

Other items are same as C rank.

Boldface type applies over the full operating temperature range. (-40 ~ 85°C)Vtest=Vout_{Typ}+1V Iout=5mA

Parameters	Symbol	Min	Typ	Max	Unit	Condition
Output Voltage	Vout	± 1.5% or ± 50mV (± 2.5% or ± 80mV)				Iout = 5mA
Line regulation	LinReg		0	6 8	mV	ΔV=5V
Load regulation 2.5V ≤ Vo ≤ 5.0V	LoaReg		0.5	1.1 1.3	%	5mA < Iout < 100mA
			1.0	2.2 2.8	%	5mA < Iout < 200mA
			1.6	3.7 5.3	%	5mA < Iout < 300mA
1.5V ≤ Vo ≤ 2.4V	LoaReg		0.8	1.8 2.0	%	5mA < Iout < 100mA
			1.5	3.4 4.1	%	5mA < Iout < 200mA
			2.4	5.3 6.5	%	5mA < Iout < 300mA
Dropout voltage	Vdrop		105	170 200	mV	Iout=100mA
			170	270 320	mV	Iout=200mA
			235	370 440	mV	Iout=300mA (2.4V & Vout) (2.2V, 2.3V : No regulation)
		1.5V & Vout & 2.1V : No regulation		Because of VopMin=2.1V		
Maximum output current	IoutMax	380 340	480		mA	Vout= (Vout _{Typ} × 0.9)
Quiescent current	Iq		65	90 100	μA	Iout=0mA except Icont
Standby current	Istandby		0	0.1 0.5	μA	Vcont ≤ 0.15V Off state
GND pin current	Ignd		1.8	3.0 3.6	mA	Iout=100mA
Control terminal Specification (Pull down resistor =500k) Note 1						
Control current	Icont		5	10 12	μA	Vcont=1.8V on state
Control voltage	Vcont	1.6 1.8			V	on state
				0.6 0.35	V	off state
Np terminal Voltage	Vnp	1.28			V	
Vo	Vo/Ta	Typ=35 ppm/°C				Reference Value
Out put noise	Vno	0.14 ~ 0.25 μV/√Hz at 1KHz				Reference Value

Note 1: The input current decreases to the pA level by connecting the control terminal to GND. (Off state). The Pull-down resistor is 500 kΩ.

General Note: Limits are guaranteed by production testing or correction techniques using Statistical Quality Control (SQC) methods. Unless otherwise noted. Vtest=Vout_{Typ}+1V ; IL=1mA (Tj=25°C) The operation of -30°C-80°C is guaranteed in the design by a usual inspection.

General Note: Exceeding the "Absolute Maximum Rating " may damage the device

General Note: Connecting a capacitor to the noise bypass pin can decrease the output noise voltage

General Note: Output noise is 0.14-0.25 μV/√Hz at 1KHz : 23 ~ 75μVrms at BW400-80kHz

General Note: The ripple rejection is 84dB at 400Hz and 80dB at 1kHz.

[CL=1.0μF, Cnp=0.01μF, Vnois=200mV_{RMS}, Vin=Vout_{Typ}+1.5v, Iout=10mA]

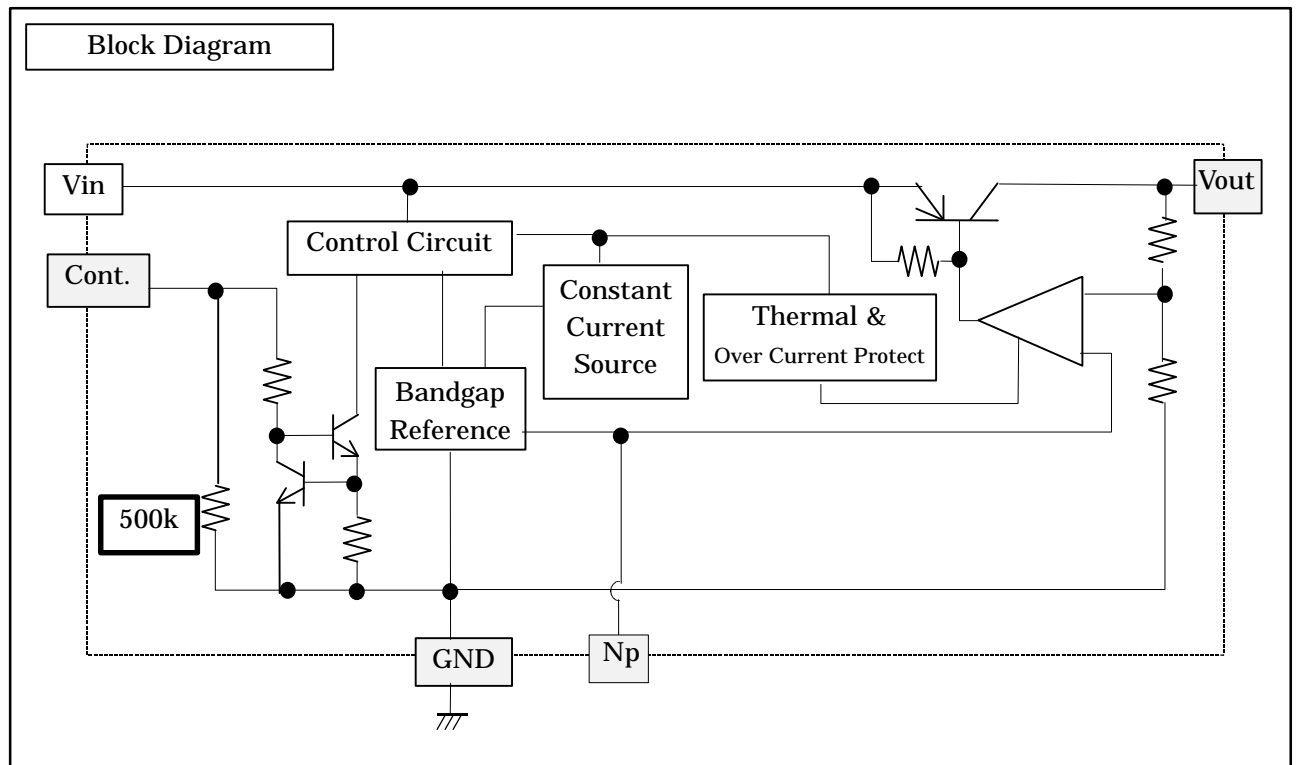
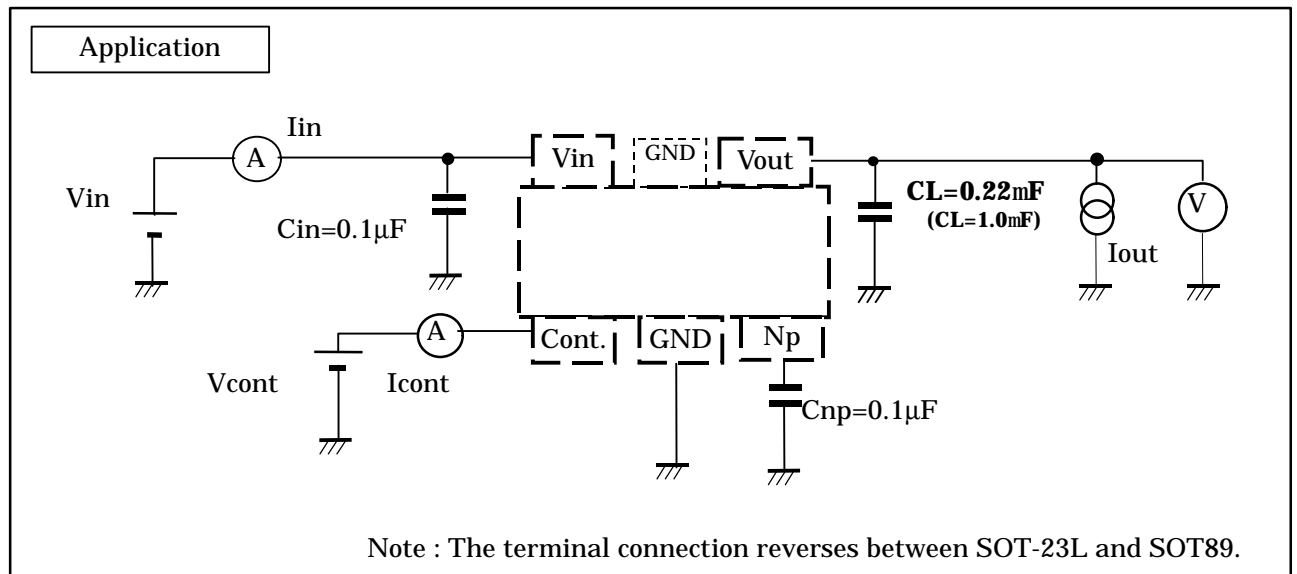
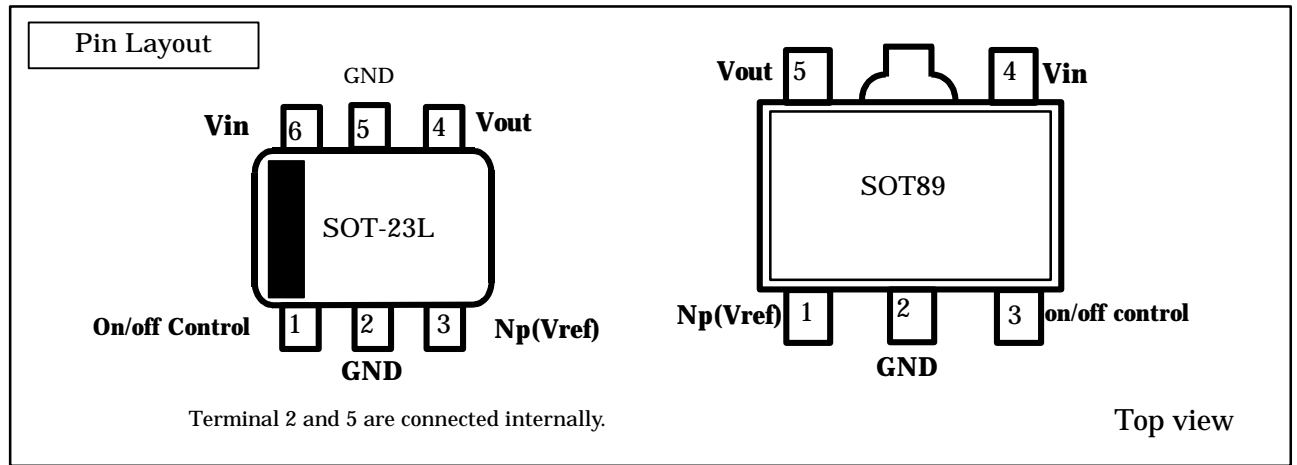

Input /Output Capacitors

Linear regulators require input and output capacitors in order to maintain the regulator's loop stability. If a 0.1μF capacitor is connected to the output side, the IC provides stable operation at any voltage in the practical current region. However, increase the CL capacitance when using the IC in the low current region and low voltage. Otherwise, the IC oscillates.

The equivalent series resistance (ESR) of the output capacitor must be in the stable operation area. However, it is recommended to use as large a value of capacitance as is practical. The output noise and the ripple noise decrease as the capacitance value increases. ESR values vary widely between ceramic and tantalum capacitors. However, tantalum capacitors are assumed to provide more ESR damping resistance, which provides greater circuit stability. This implies that a higher level of circuit stability can be obtained by using tantalum capacitors when compared to ceramic capacitors with similar values.

The recommended value : $C_{in}=C_L=0.22\mu F$ (MLCC) $I_{out} \geq 0.5mA$.

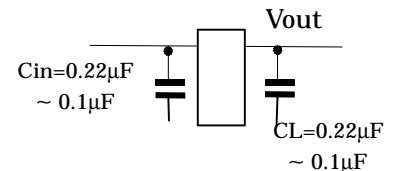

The input capacitor is necessary when the battery is discharged, the power supply impedance increases, or the line distance to the power supply is long.

This capacitor might be necessary on each individual IC even if two or more regulator ICs are used. It is not possible to determine this indiscriminately. Please confirm the stability while mounted. The IC provides stable operation with an output side capacitor of 0.1μF ($V_{out} \geq 2.5V$). If it is 0.1μF or more over the full range of temperature, either a ceramic capacitor or tantalum capacitor can be used without considering ESR. It is not possible to say indiscriminately. Please confirm stability while mounted.

Output voltage, Output current vs. Stable Operation Area

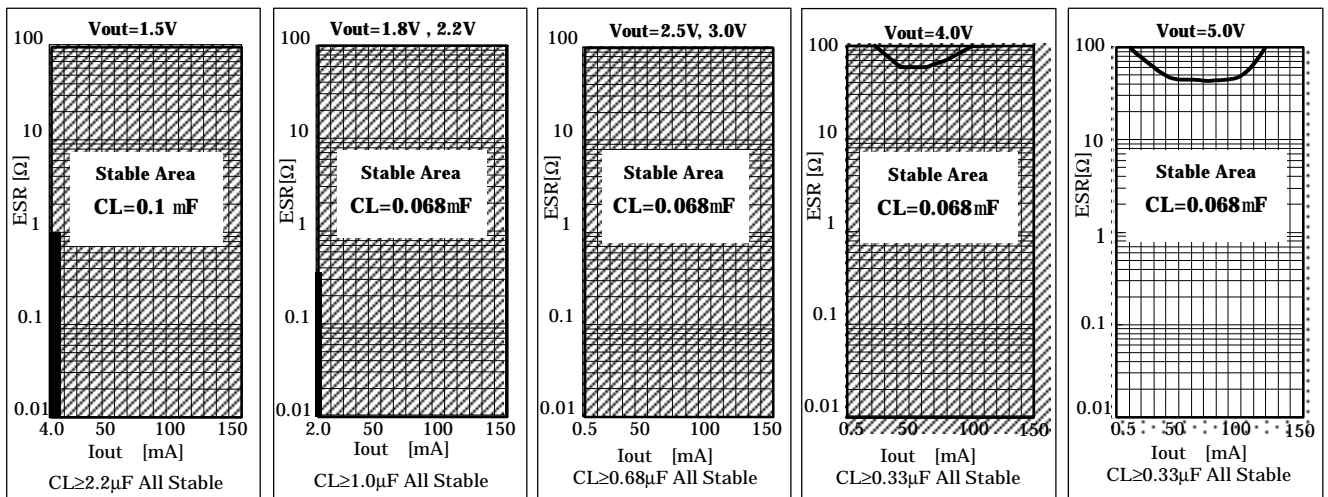

The above graphs show stable operation with a ceramic capacitor of 0.1μF (excluding the low current region). If the capacitance is not increased in the low voltage, low current area, stable operation may not be achieved. Please select the best output capacitor according to the voltage and current used. The stability of the regulator improves if a big output side capacitor is used (the stable operation area extends.) Please use as large a capacitance as is practical. Although operation above 150 mA has not been described, stability is equal to or better than operation at 150 mA.

For evaluation Kyocera :CM05B104K10AB , CM05B224K10AB , CM105B104K16A , CM105B224K16A , CM21B225K10A
 Murata :GRM36B104K10 , GRM42B104K10 , GRM39B104K25 , GRM39B224K10 , GRM39B105K6.3

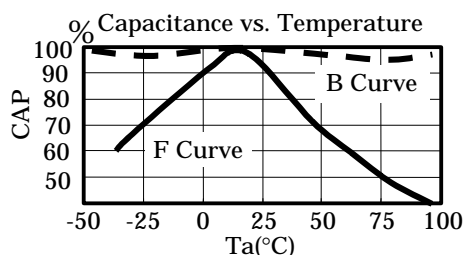
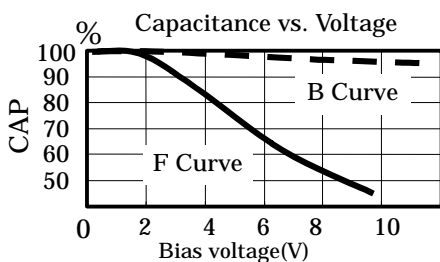

Generally, a ceramic capacitor has both a temperature characteristic and a voltage characteristic. Please consider both characteristics when selecting the part. The B curves are the recommend characteristics.

Output noise

TK11230C Cnp vs. Noise Iout=30mA BPF=400Hz ~ 80kHz

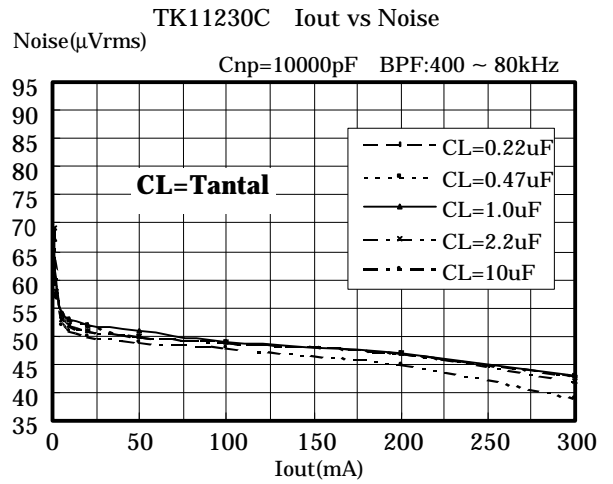
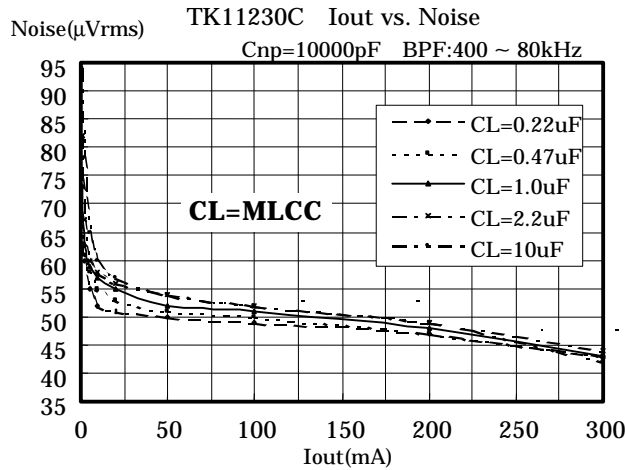
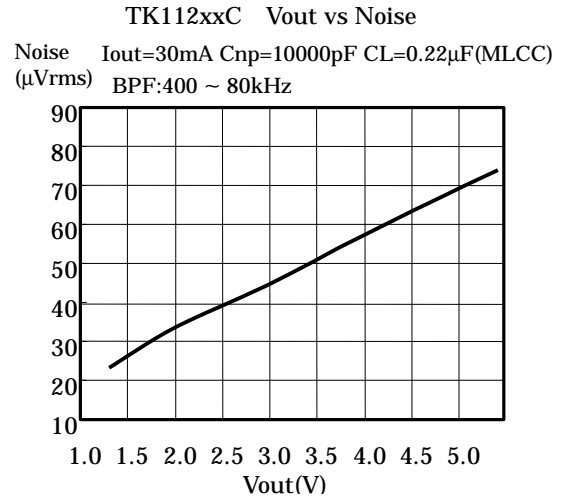
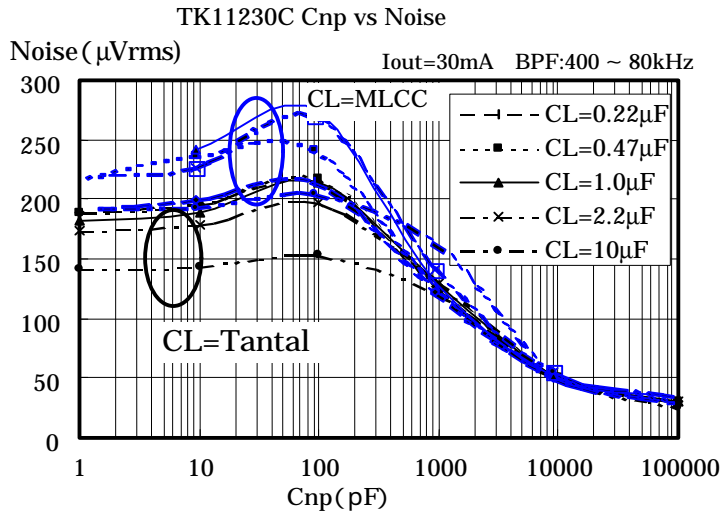

Increase Cnp to decrease the noise. The recommended Cnp capacitance is 6800pF(682) ~ 0.22µF(224). The amount of noise increases with the higher output voltages.

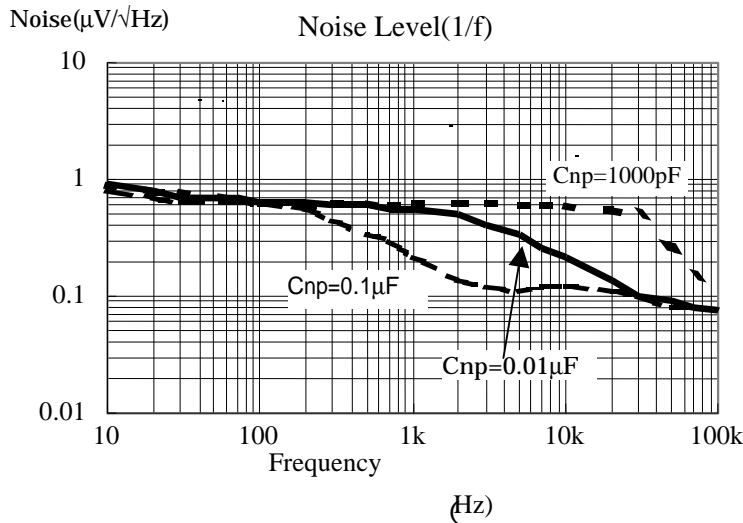

TK11230CM Cin=10µF Iout=10mA
CL=0.22mF (Ceramic)

Ripple rejection

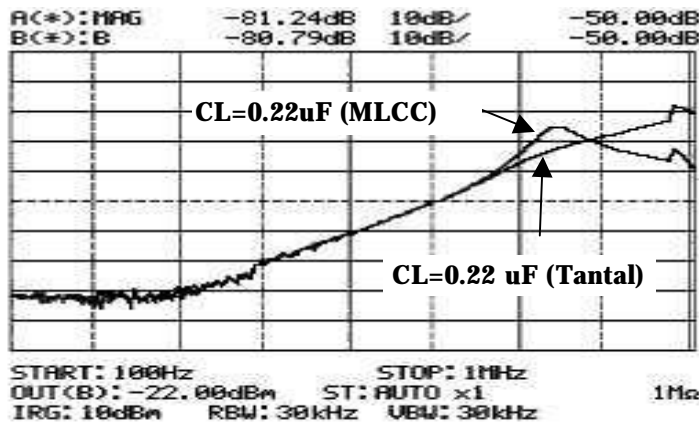

Vin=5.0V Vout=3.0V Iout=10mA
VR=500mVp-p f=100 ~ 1MHz Cnp=0.1uF

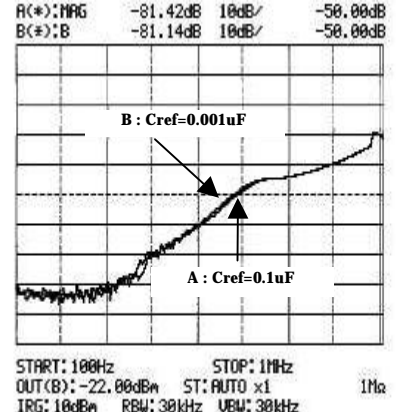
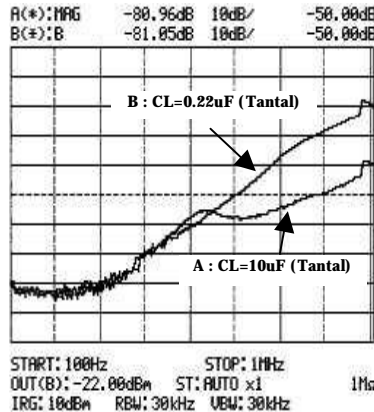
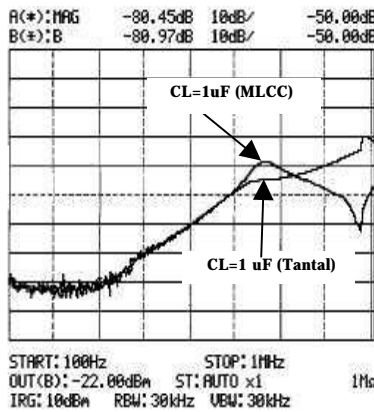
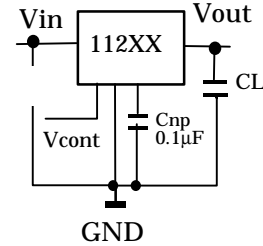

The ripple rejection characteristic depends on the characteristic and the capacitance value of the capacitor connected to the output side. The RR characteristic of 50KHz or more varies greatly with the capacitor on the output side and PCB pattern. If necessary, please confirm stability while operating.

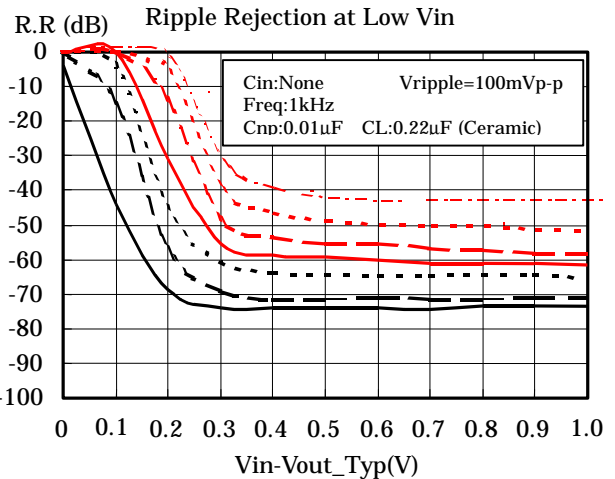
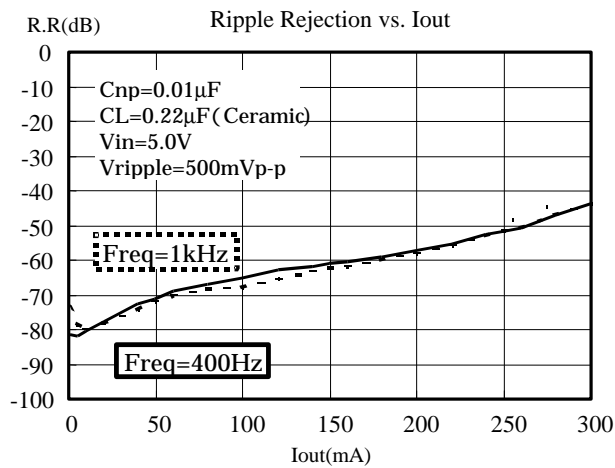

TK112xxCM Transient

· ON / OFF Transient

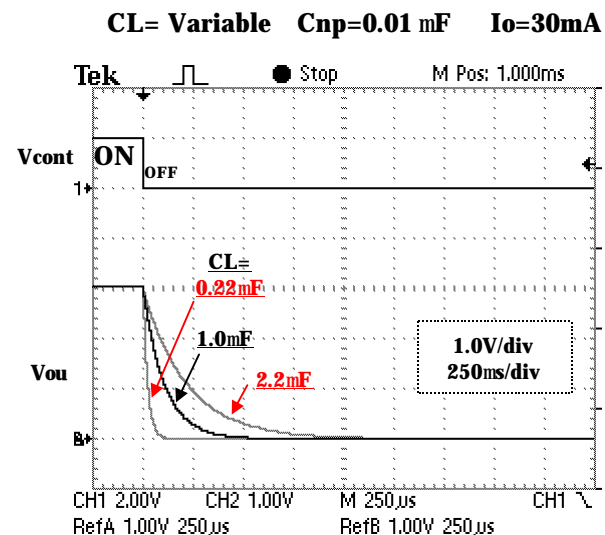
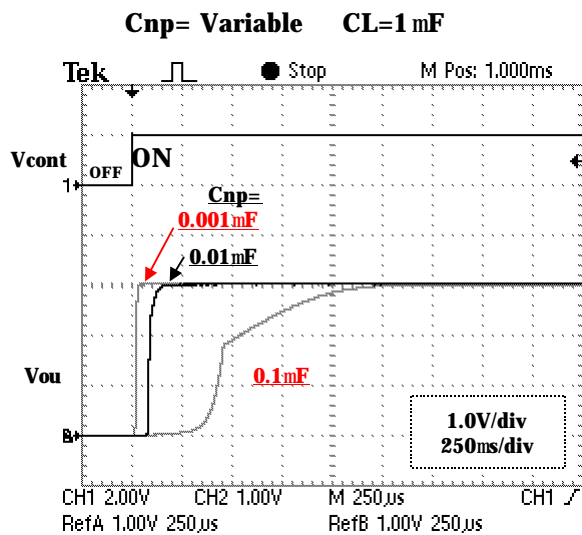
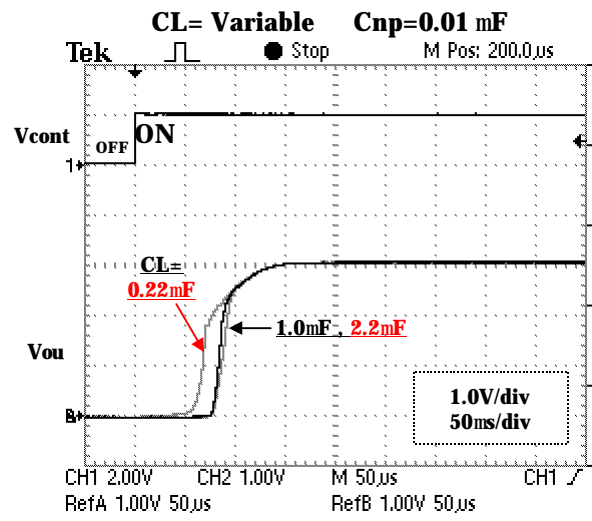
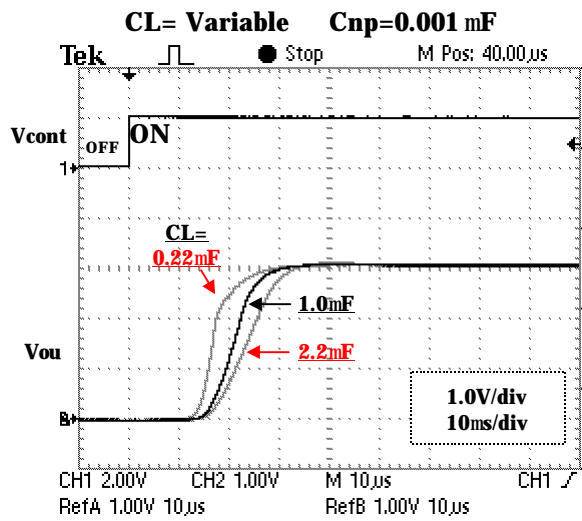
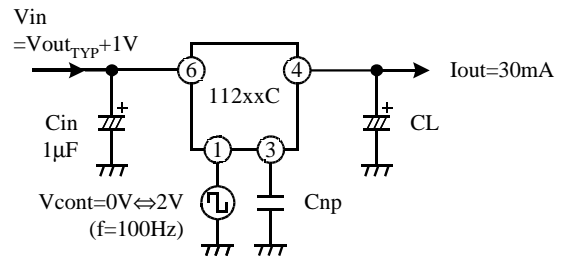

The rise time of the regulator depends on CL and Cnp; the fall time depends on CL.

• LOAD Transient

CL= Variable Cnp=0.01 mF

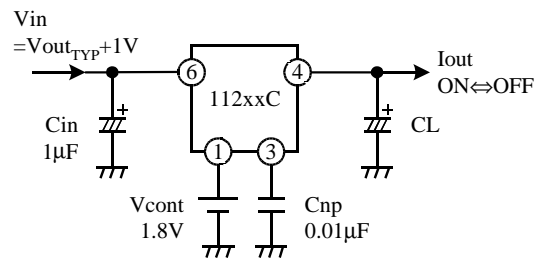
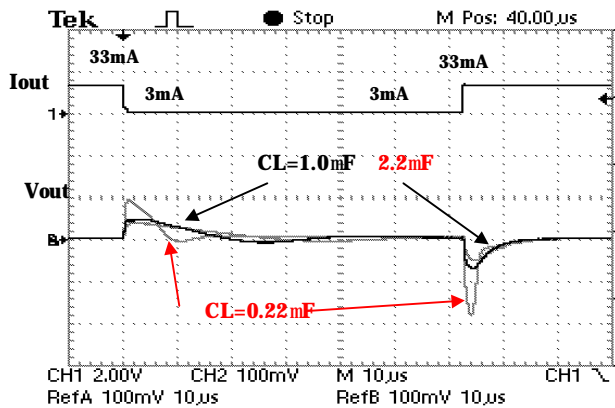

When the capacitor on the load side is increased, the load change becomes smaller.

Iout=0 ↔ 30mA , 3 ↔ 33mA

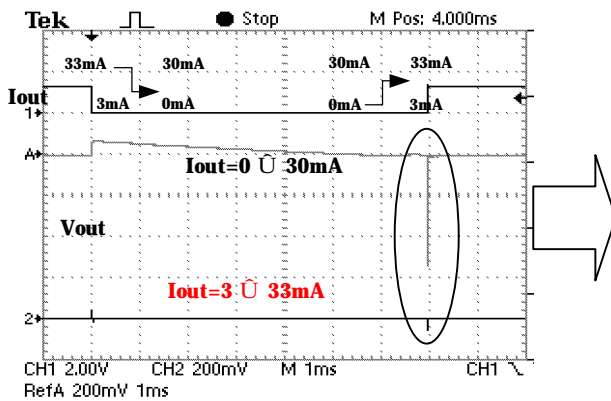

Magnification

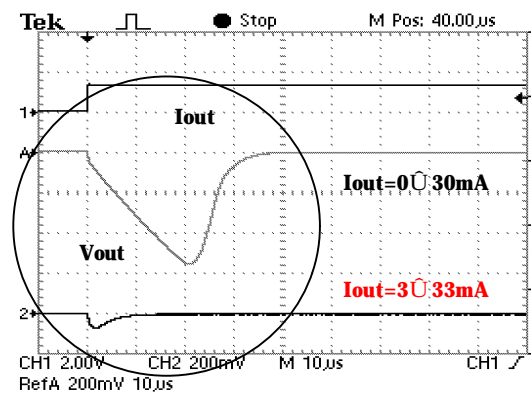

The no load voltage change can be greatly improved by delivering a little load current to ground (see right curve above).

Increase the load side capacitor when the load change is fast or when there is a large current change. In addition, at no load, the voltage change can be reduced by delivering a little load current to ground.

• Line Transient

CL= Variable Cnp=0.01 mF

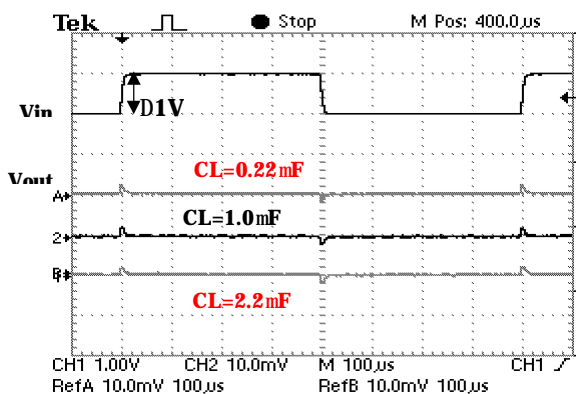

Cnp= Variable CL=1 mF

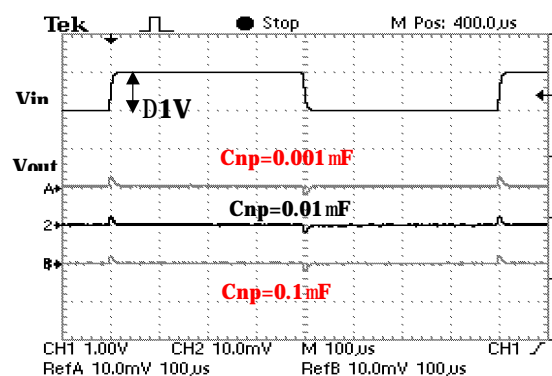

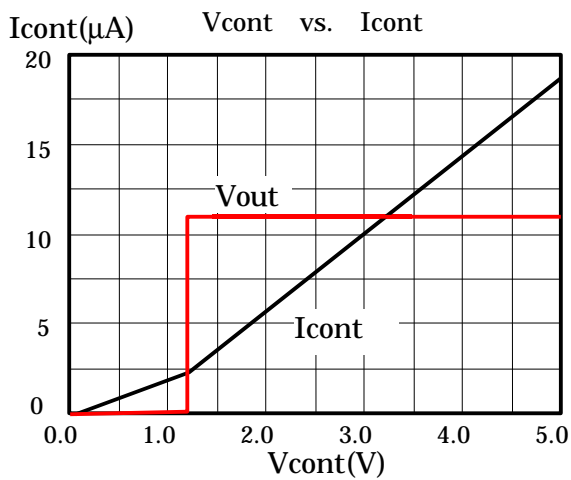
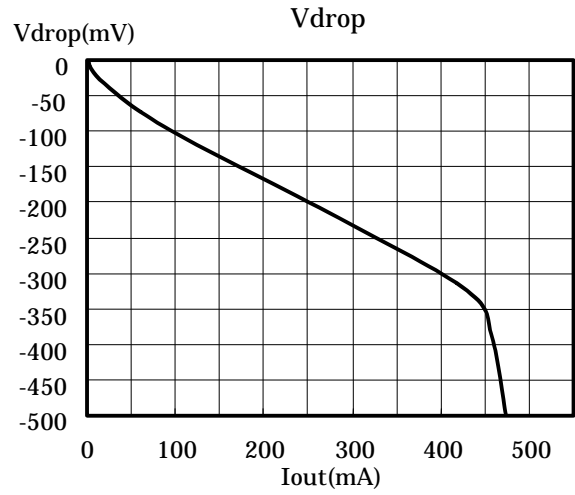
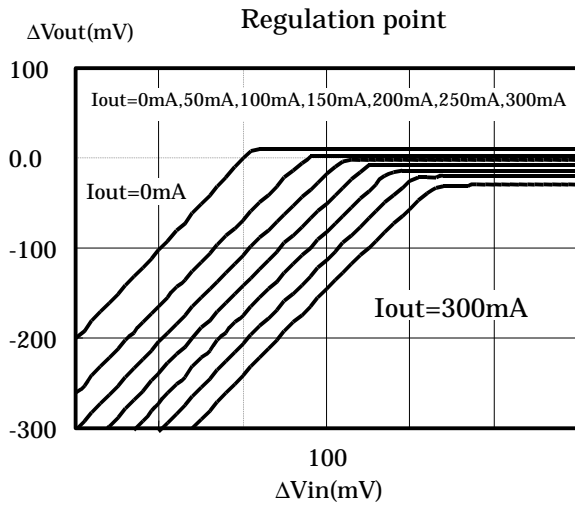
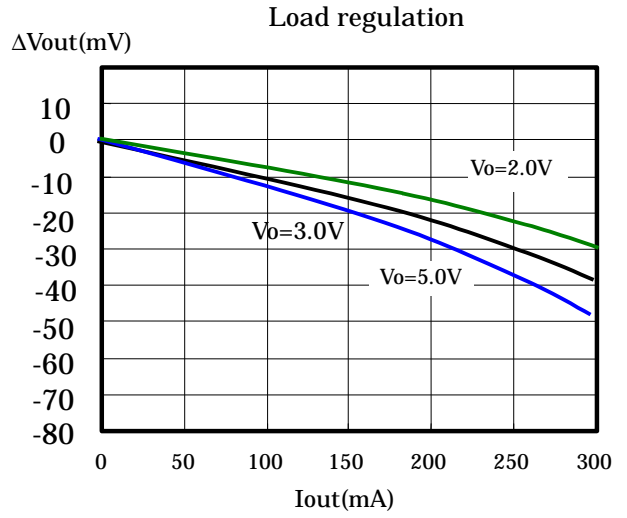
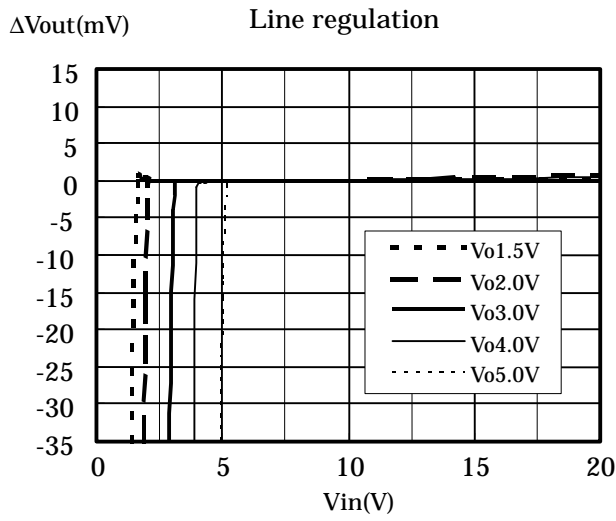

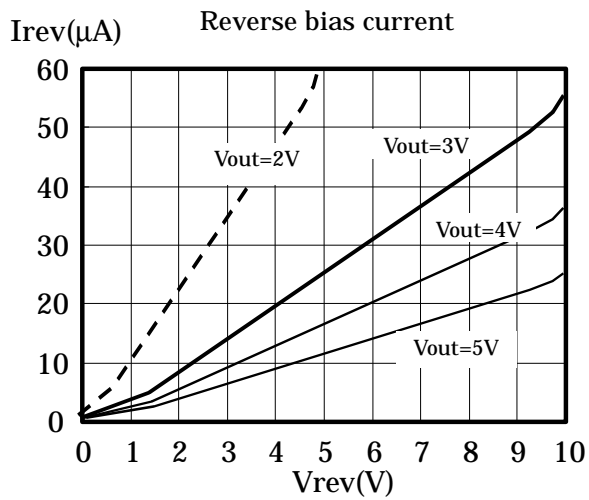
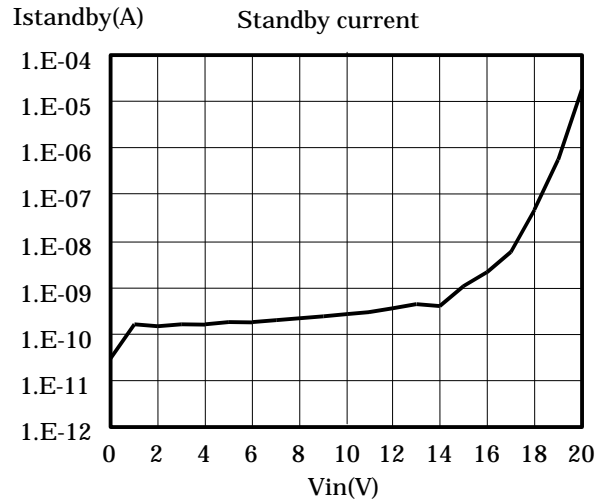
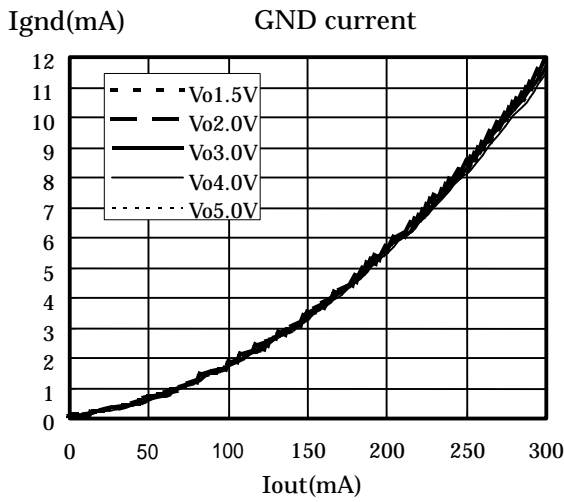
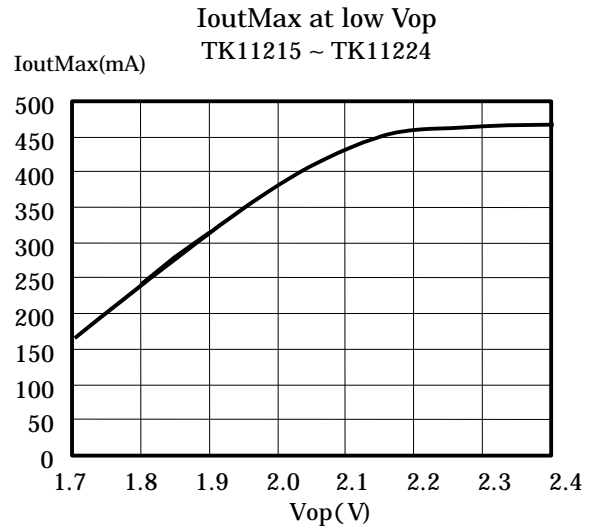
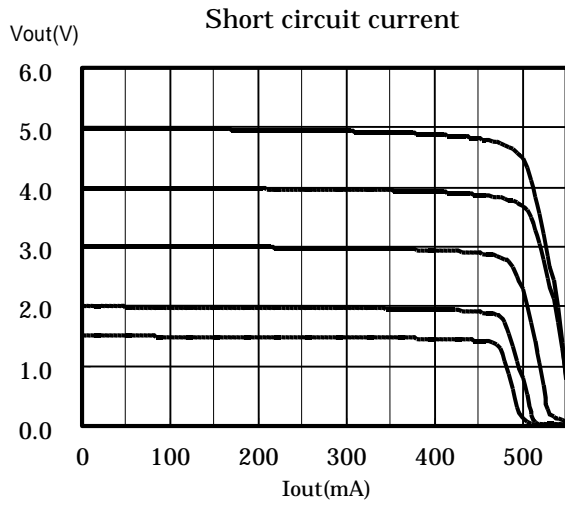

Temperature Characteristics

(Ta: Ambient temperature)

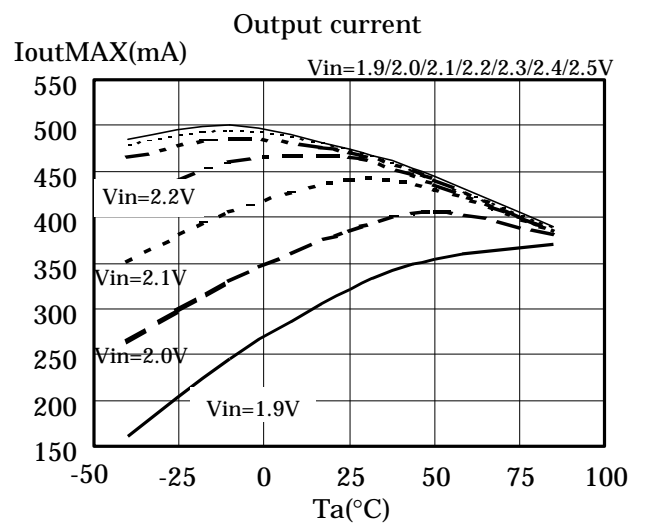
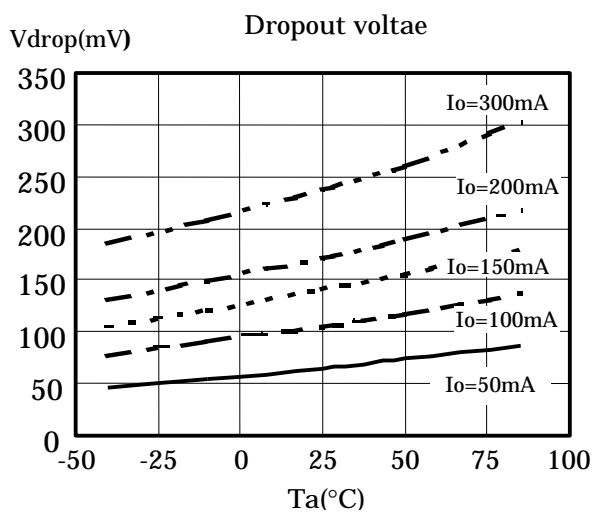
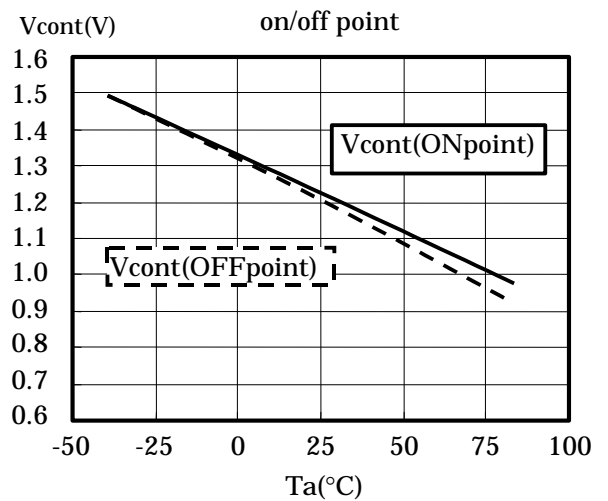
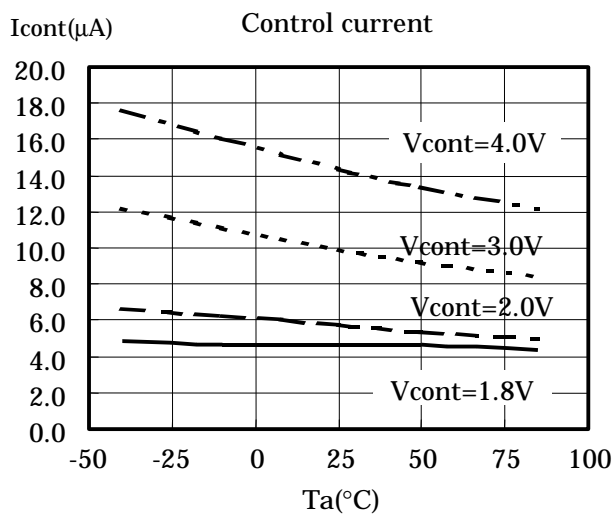
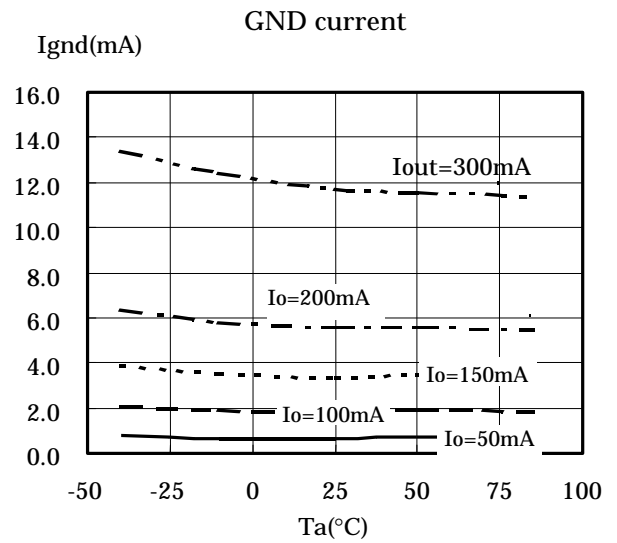
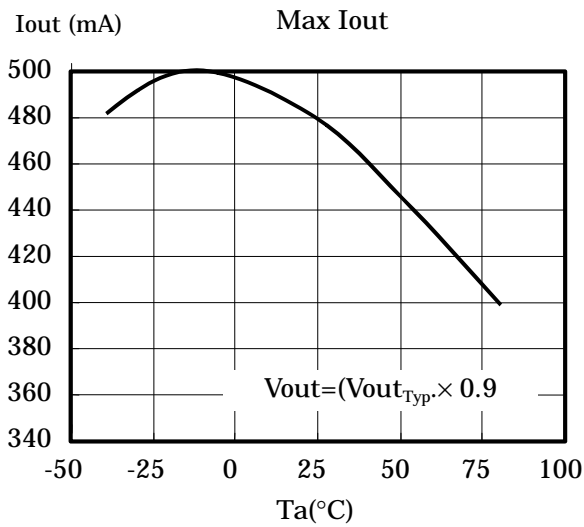

Output voltage vs. Temperature characteristics

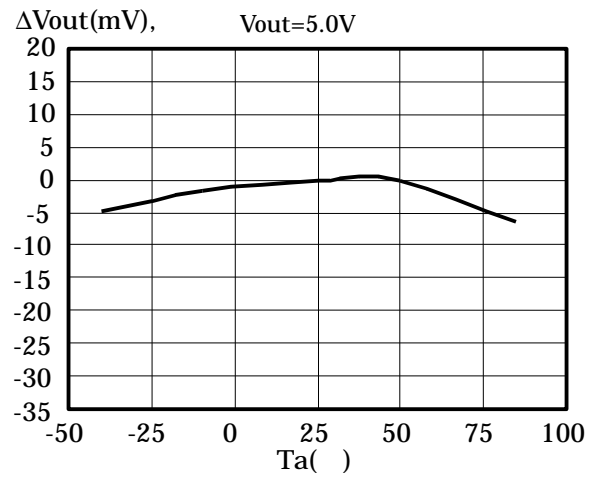
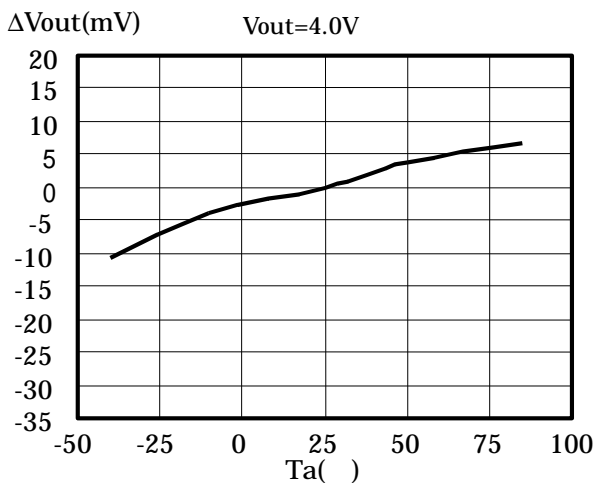
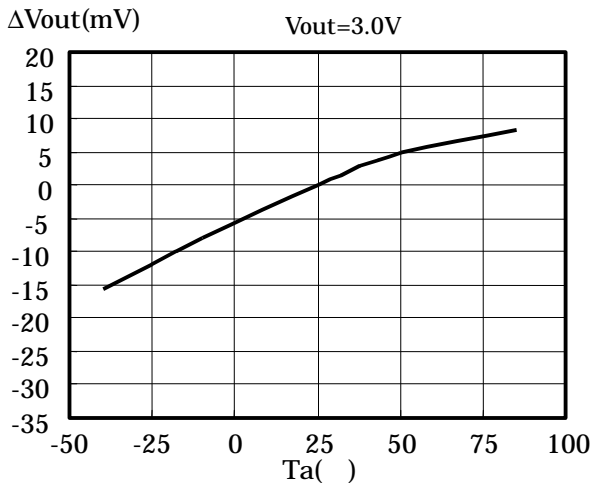
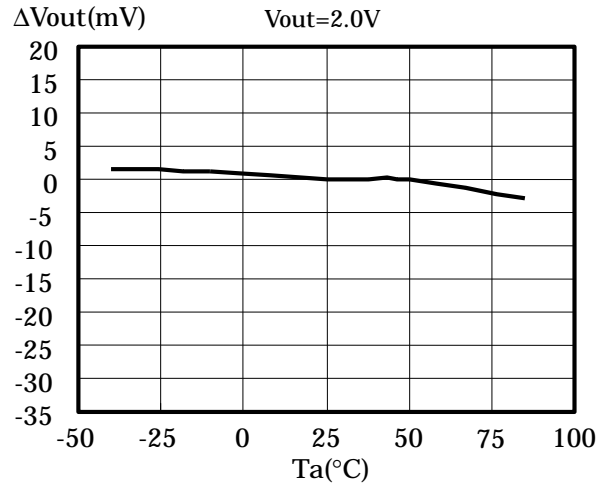
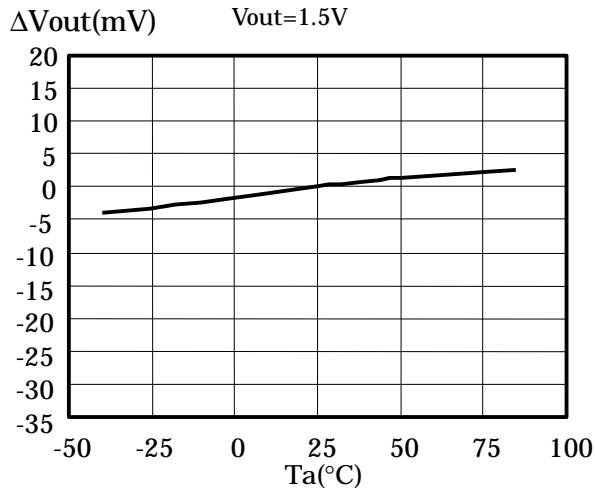

Layout PCB Material : Glass epoxy t=0.8mm

SOT23L-6

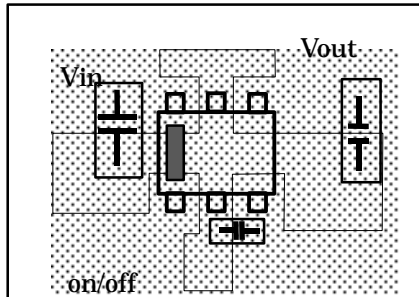

Please do derating with 4mW/°C at Pd=600mW and 25°C or more. Thermal resistance is ($\theta_{ja}=250^{\circ}\text{C} / \text{W}$).

SOT89-5

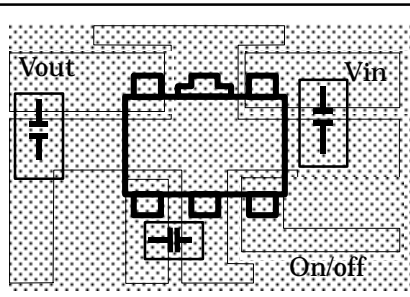

Please do derating with 7.2mW/°C at Pd=900mW and 25°C or more. Thermal resistance is ($\theta_{ja}=138^{\circ}\text{C} / \text{W}$).

Derating Curve

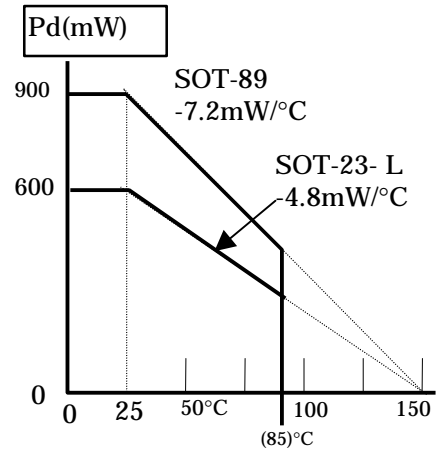

The package loss is limited at the temperature that the internal temperature sensor works (about 150°C). Therefore, the package loss is assumed to be an internal limitation. There is no heat radiation characteristic of the package unit assumed because of the small size. Heat is carried away by the device being installed on the PCB. This value changes by the material and the copper pattern etc. of the PCB. The losses are approximately 600mW (SOT-23L) : 900mW(SOT-89). Enduring these losses becomes possible in a lot of applications operating at 25°C.

Determining the thermal resistance when mounted on a PCB.

The operating chip junction temperature is shown by $T_j = \theta_{ja} \times P_d + T_a$. T_j of the IC is set to about 150°C. P_d is a value when the overtemperature sensor is made to work.

$$T_a (T_a=25^{\circ}\text{C})$$

$$150 = \theta_{ja} \times p_d + 25$$

$$\theta_{ja} \times P_d = 125$$

$$\theta_{ja} = (125 / p_d) (^{\circ}\text{C} / \text{mW})$$

Pd is easily obtained.

Mount the IC on the print circuit board. Short between the output pin and ground. after that, raise input voltage from 0V to evaluated voltage (see*1) gradually.

At shorted the output pin, the power dissipation P_D can be expressed as $P_d = V_{in} \times I_{in}$. The input current decreases gradually as the temperature of the chip becomes high. After a while, it reaches the thermal equilibrium. Use this current value at the thermal equilibrium. In almost all the cases, it shows 600mW(SOT23L-6) : 900mW(SOT89-5) or more.

*1 In the case that the power, $V_{in} \times I_{short}$ (Short Circuit Current), becomes more than twice of the maximum rating of its power dissipation in a moment, there is a possibility that the IC is destroyed before internal thermal protection works.

P_d is obtained by the normal temperature in degrees. The current that can be used at the highest operating temperature is obtained from the graph of the figure below.

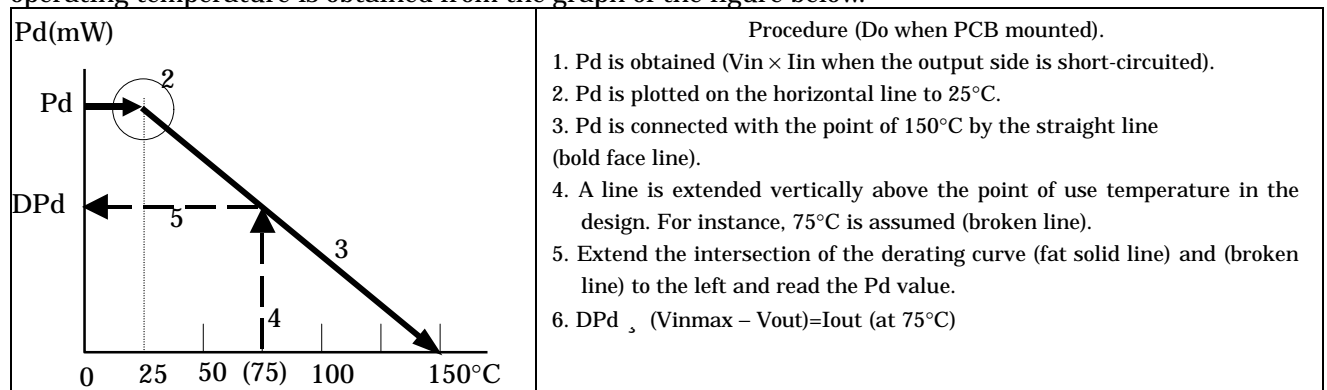

The maximum current that can be used at the highest operating temperature is:
 $I_{out} @ DP_d \text{ } _j (V_{inmax} - V_{out})$

Application hint

On/Off Control

It is recommended to turn the regulator Off when the circuit following the regulator is non-operating. A design with little electric power loss can be implemented. We recommend the use of the on/off control of the regulator without using a high side switch to provide an output from the regulator. A highly accurate output voltage with low voltage drop is obtained.

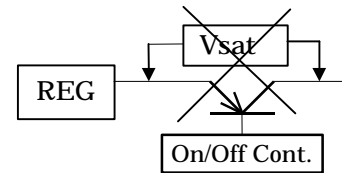

Because the control current is small, it is possible to control it directly by CMOS logic.

The PULLDOWN resistance (500K Ω) is built into the control terminal.

The noise and the ripple rejection characteristics depend on the capacitance on the Vref terminal.

The ripple rejection characteristic of the low frequency region improves by increasing the capacitance of Cnp.

A standard value is Cnp=0.068 μ F. Increase Cnp in a design with important output noise and ripple rejection requirements. The IC will not be damaged if the capacitor value is increased.

The on/off switching speed changes depending on the Np terminal capacitance. The switching speed slows when the capacitance is large.

Parallel connected ON/OFF Control

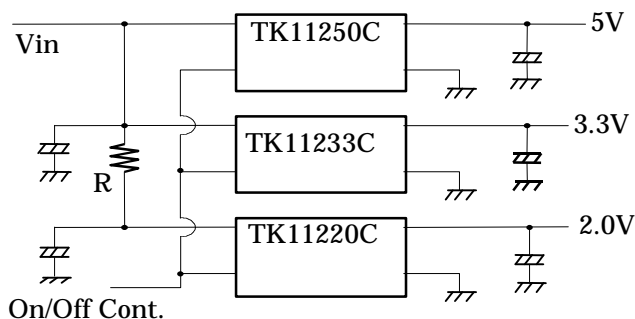

The figure at the left illustrates multiple regulators being controlled by a single On/Off control signal. There is a possibility of overheating because the power loss of the low voltage side IC (TK11220C) is large. The series resistor (R) is put in the input line of the low output voltage regulator in order to prevent over-dissipation. The voltage dropped across the resistor reduces the large input-to-output voltage across the regulator, reducing the power dissipation in the device. When the thermal sensor works, a decrease of the output voltage, oscillation, etc. may be observed.

Current boost

For current boost applications, use the products below. A low voltage drop, high current regulator can be easily made.

TK714xx Only the PNP transistor for the current boost is external.

TK732xx (For Iout=10A Max regulator)

Built-in Short circuit protection: a constant current can be set by an external resistor.

Definition of Terms

The output voltage tables are specified with a test voltage of $V_{in} = \text{Output Voltage (Typ.)} + 1V$.

Output Voltage (V_{out})

The output voltage is specified with ($V_{in} = \text{Output Voltage (Typ.)} + 1V$) and output current ($I_{out} = 5mA$).

Maximum Output Current ($I_{out Max}$)

The output current is measured when the output voltage decreases to ($V_{out_{Typ.}} \times 0.9$). The input voltage is ($\text{Output Voltage (Typ.)} + 1V$). The maximum output current is measured in a short time so that it is not influenced by the temperature of the chip. The output current decreases with low voltage operation.

Please refer to the "Low input voltage-output current" graph for 2.1V or less.

Dropout Voltage (V_{drop})

The dropout voltage is the difference between the input voltage and the output voltage at which point the regulator starts to fall out of regulation. Below this value, the output voltage will fall as the input voltage is reduced. It is dependent upon the load current (I_{out}) and the junction temperature (T_j). The input voltage is gradually decreased below the test voltage. It is the voltage difference between the input and the output when the output voltage decreases by 100mV.

Line Regulation ($Lin Reg$)

Line regulation is the ability of the regulator to maintain a constant output voltage as the input voltage changes. The line regulation is specified as the input voltage is changed from ($\text{Output Voltage (Typ.)} + 1V$) to ($\text{Output Voltage (Typ.)} + 6V$). This measurement is not influenced by the temperature of the IC and is measured in a short time.

Load Regulation ($Load Reg$)

Load regulation is the ability of the regulator to maintain a constant output voltage as the load current changes. The input voltage is set to ($\text{Output Voltage (Typ.)} + 1V$). The output voltage change is measured as the load current changes from 5 to 100mA and from 5 to 200mA. This measurement is not influenced by the temperature of the IC and is measured in a short time.

Quiescent Current (I_q)

The quiescent current is the current which flows through the ground terminal under no load conditions ($I_o = 0mA$).

Ripple Rejection (RR)

Ripple rejection is the ability of the regulator to attenuate the ripple content of the input voltage at the output. It is specified with the input voltage = ($V_{out} + 1.5V$), $I_{out} = 10mA$, $C_L = 1.0\mu F$ and $C_{np} = 0.01\mu F$. An Alternating Current source of ($f = 1KHz$ and $200mV_{RMS}$) is superimposed to the power-supply voltage. Ripple rejection is the ratio of the ripple content of the output vs. the input and is expressed in dB. It is typically about 80dB at 1KHz. The ripple rejection improves when the value of the capacitor at the noise bypass terminal in the circuit is large. However, the on/off response worsens.

Standby Current.($I_{standby}$)

Standby current is the current which flows into the regulator when the control voltage is made 0 volts. It is measured with an input voltage of 8V.

PROTECTION CIRCUIT S**Thermal Sensor**

The thermal sensor protects the device if the junction temperature exceeds the safe value ($T_j=150$ °C). This temperature rise can be caused by extreme heat, excessive power dissipation caused by large output voltage drops, or excessive output current. The regulator will shut off when the temperature exceeds the safe value. As the junction temperature decreases, the regulator will begin to operate again. Under sustained fault conditions, the regulator output will oscillate as the device turns off then resets. Please improve heat radiation or lower the input electric power. When heat radiation is poor, the forecast package loss is not obtained.

* In the case that the power, $V_{in} \times I_{short}$ (Short Circuit Current), becomes more than twice of the maximum rating of its power dissipation in a moment, there is a possibility that the IC is destroyed before internal thermal protection works.

Reverse Bias Current

The reverse bias protection prevents excessive current from flowing through the IC even if the input voltage becomes 0 with voltage impressed on the output side (input short-circuited to GND). The maximum reverse bias voltage is 6V.

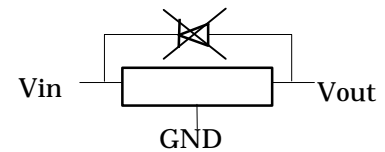

- ESD MM 200pF 0Ω 200V Min
HBM 100pF 1.5kΩ 2000V Min

Outline ; PCB ; Stamps

SOT23L-6

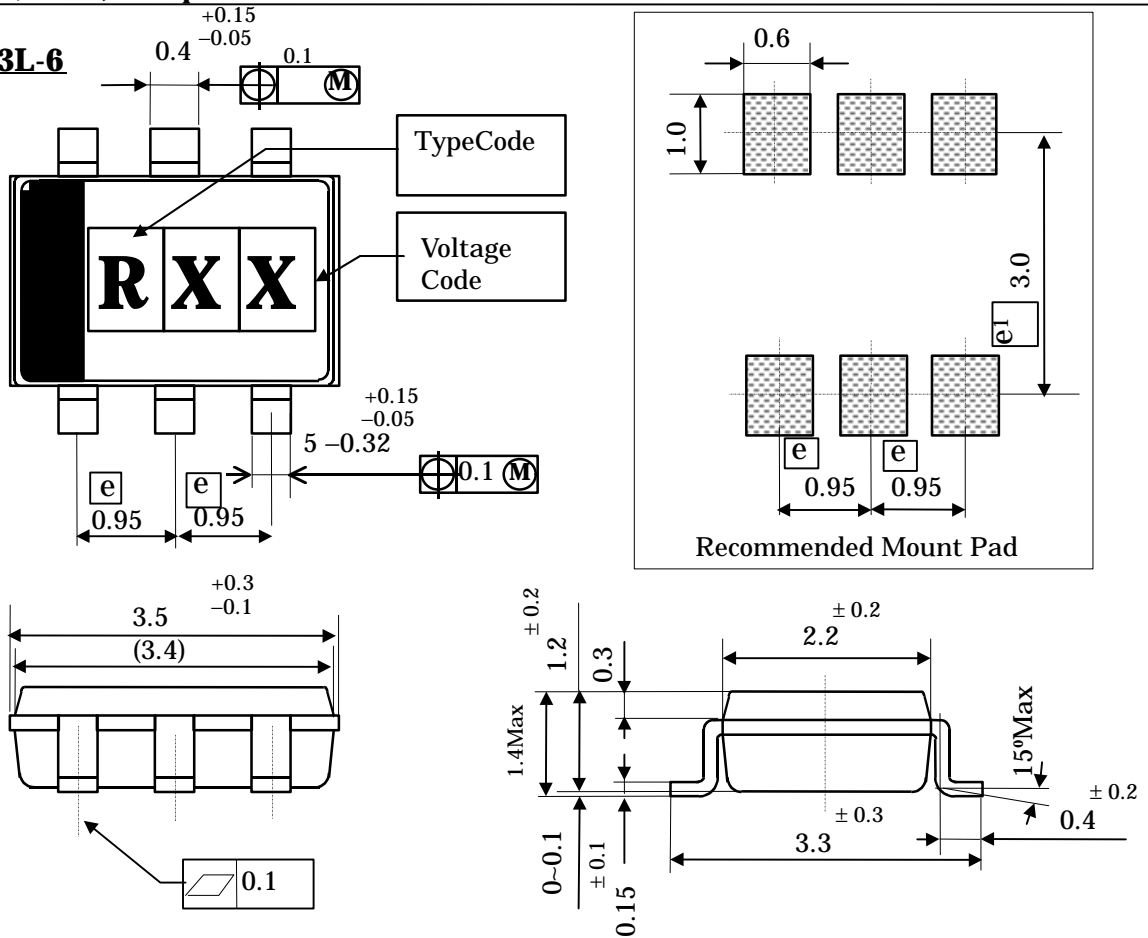

Unit : mm
General tolerance : ± 0.2

Molded Resin with Body : Epoxy Resin
Lead Frame : Copper Alloy
Treatment : Solder Plating(5~15µm)
Marking Method : Ink or Laser
Weight : 0.023g
Country of origin : Japan or Korea

V OUT	V CODE	V OUT	V CODE	V OUT	V CODE	V OUT	V CODE
1.5 v	15	2.5 v	25	3.5 v	35	4.5 v	45
1.6	16	2.6	26	3.6	36	4.6	46
1.7	17	2.7	27	3.7	37	4.7	47
1.8	18	2.8	28	3.8	38	4.8	48
1.9	19	2.9	29	3.9	39	4.9	49
2.0	20	3.0	30	4.0	40	5.0	50
2.1	21	3.1	31	4.1	41		
2.2	22	3.2	32	4.2	42		
2.3	23	3.3	33	4.3	43		
2.4	24	3.4	34	4.4	44		

The output voltage table indicates the standard value when manufactured.
Please contact your authorized Toko representative for voltage availability

SOT89-5

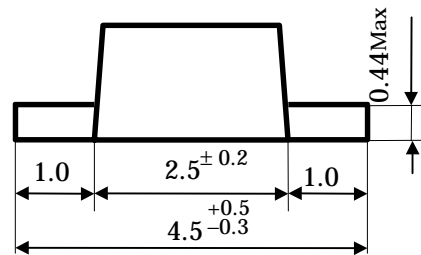
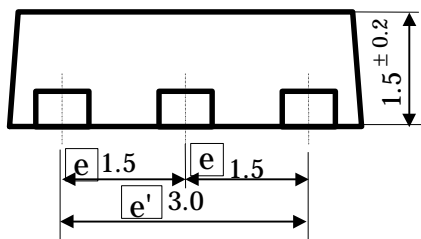
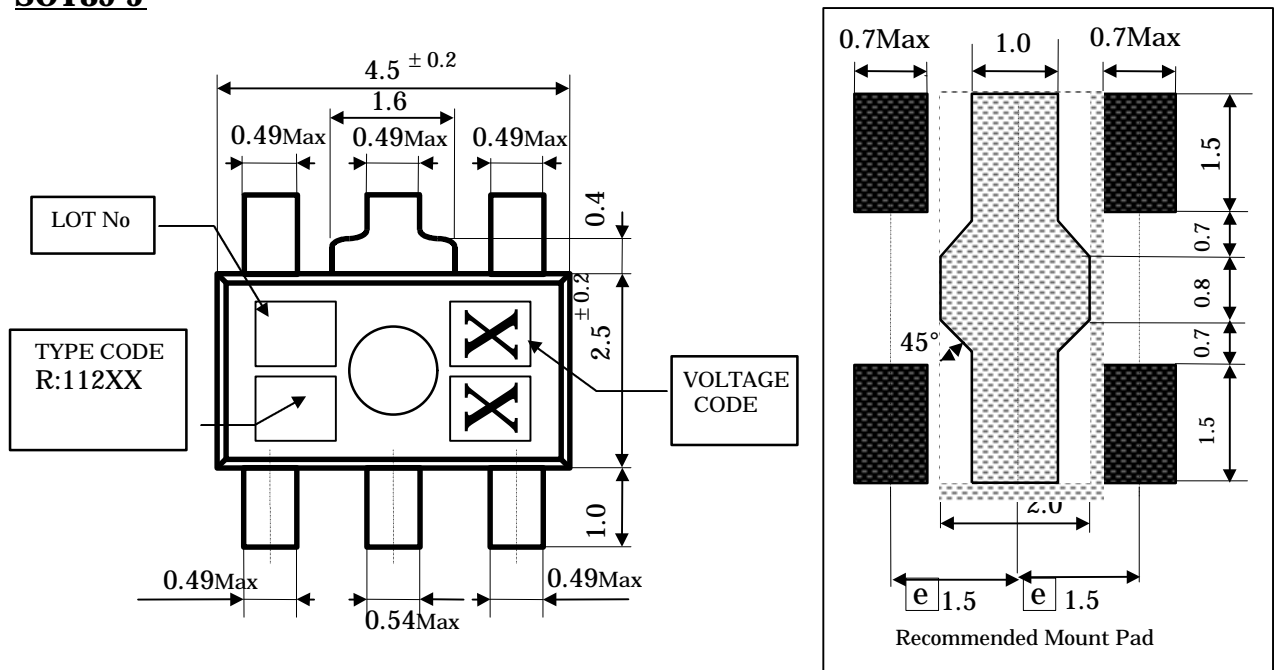

Unit : mm
General tolerance : ± 0.2

Molded Resin with Body : Epoxy Resin
Lead Frame : Copper Alloy
Treatment : Solder Plating(5-15 μm)
Marking Method : Ink or Laser
Weight : 0.053 g
Country of origin : Japan

V OUT	V CODE	V OUT	V CODE	V OUT	V CODE	V OUT	V CODE
1.5 v	15	2.5 v	25	3.5 v	35	4.5 v	45
1.6	16	2.6	26	3.6	36	4.6	46
1.7	17	2.7	27	3.7	37	4.7	47
1.8	18	2.8	28	3.8	38	4.8	48
1.9	19	2.9	29	3.9	39	4.9	49
2.0	20	3.0	30	4.0	40	5.0	50
2.1	21	3.1	31	4.1	41		
2.2	22	3.2	32	4.2	42		
2.3	23	3.3	33	4.3	43		
2.4	24	3.4	34	4.4	44		

The output voltage table indicates the standard value when manufactured.
Please contact your authorized Toko representative for voltage availability

NOTE

Please be sure that you carefully discuss your planned purchase with our office if you intend to use the products in this data sheet under conditions where particularly extreme standards of reliability are required, or if you intend to use products for applications other than those listed in this data sheet.

- Power drive products for automobile, ship or aircraft transport systems; steering and navigation systems, emergency signal communications systems, and any system other than those mentioned above which include electronic sensors, measuring, or display devices, and which could cause major damage to life, limb or property if misused or failure to function.
 - Medical devices for measuring blood pressure, pulse, etc., treatment units such as coronary pacemakers and heat treatment units, and devices such as artificial organs and artificial limb systems which augment physiological functions.
 - Electrical instruments, equipment or systems used in disaster or crime prevention.
- Semiconductors, by nature, may fail or malfunction in spite of our devotion to improve product quality and reliability. We urge you to take every possible precaution against physical injuries, fire or other damages which may cause failure of our semiconductor products by taking appropriate measures, including a reasonable safety margin, malfunction preventive practices and fire-proofing when designing your products.
 - This data sheet is effective from **Oct. 2002**. Note that the contents are subject to change or discontinuation without notice. When placing orders, please confirm specifications and delivery condition in writing.
 - TOKO is not responsible for any problems nor for any infringement of third party patents or any other intellectual property rights that may arise from the use or method of use of the products listed in this data sheet. Moreover, this data sheet does not signify that TOKO agrees implicitly or explicitly to license any patent rights or other intellectual property rights which it holds.
 - None of ozone depleting substances(ODS) under the Montreal Protocol is used in manufacturing process of us.

If you need more information on this product and other TOKO products, please contact us.

OFFICE

■ TOKO Inc. Headquarters

1-17, Higashi-yukigaya 2-chome, Ohta-ku, Tokyo, 145-8585, Japan

TEL: +81.3.3727.1161

FAX: +81.3.3727.1176 or +81.3.3727.1169

Web site: <http://www.toko.co.jp/>

■ TOKO America

Web site: <http://www.toko.com/>

■ TOKO Europe

Web site: <http://www.tokoeurope.com/>

■ TOKO Hong Kong

Web site: <http://www.toko.com.hk/>

■ TOKO Taiwan

Web site: <http://www.tokohc.com.tw/>

■ TOKO Singapore

Web site: <http://www.toko.com.sg/>

■ TOKO Seoul

Web site: <http://www.toko.co.kr/>

■ TOKO Manila

Web site: <http://www.toko.com.ph/>

■ TOKO Brazil

Web site: <http://www.toko.com.br/>



TO BUILD THE QUALITY RELIED BY CUSTOMERS

Semiconductor Division

YOUR DISTRIBUTOR