

SINGLE INPUT, TWO OUTPUT SOLID STATE SWITCH

FEATURES

- Internal PNP Power Transistor
- Reverse Bias Voltage Protection
- Very Low Input-Output Voltage Difference
- Very Low Standby Current
- Overtemperature Protection
- Single Input with Two Controlled Outputs
- Active High On/Off Control

APPLICATIONS

- Battery Powered Systems
- Radio Control Systems
- Automatic Test Equipment (ATE)
- Power Management
- Process Control Equipment
- Power Distribution Control

DESCRIPTION

The TK70002 is a monolithic bipolar integrated circuit with high side current switches of low saturation type. The supply current, including the control current, is virtually zero (pA level) when the control pin is "off". The impedance on the output side is high and the reverse current does not flow when the control pin is "off." These are effective to decrease the dissipation currents, making the TK70002 a very efficient device for power management and power distribution control.

The TK70002 is available in a miniature SOT-23-6 surface mount package. When mounted as recommended, this package is capable of dissipating up to 350mW.

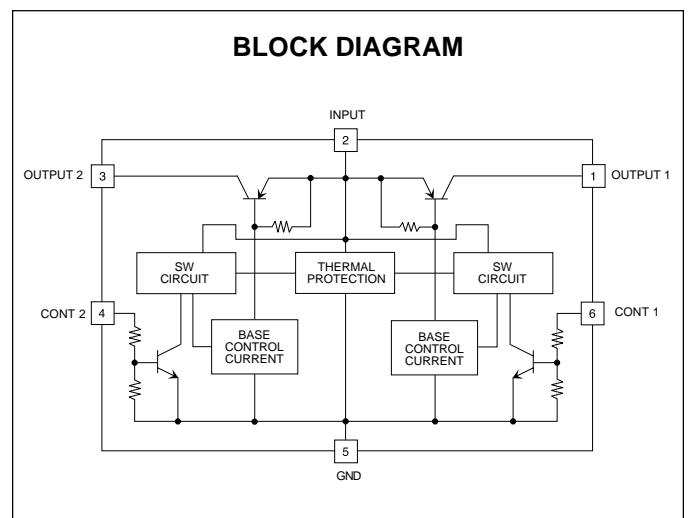
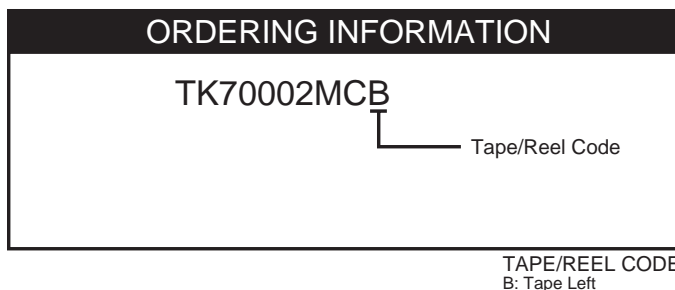
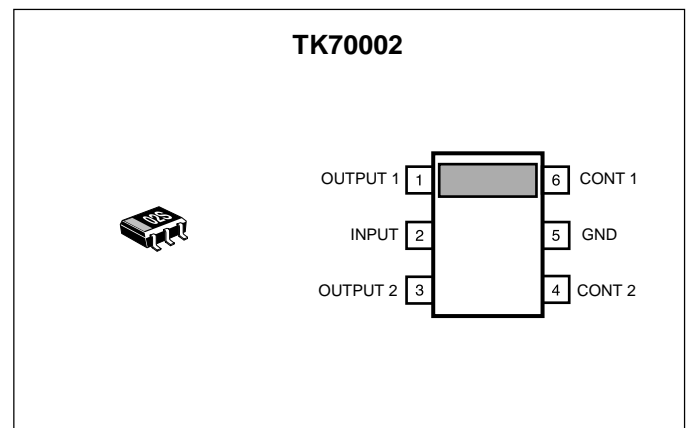

TK70002

ABSOLUTE MAXIMUM RATINGS

Supply Voltage	14 V	Storage Temperature Range	-55 to +150 °C
Output Current	130 mA	Operating Temperature Range	-30 to +80 °C
Power Dissipation (Note 1)	350 mW	Operating Voltage Range	1.6 to 12 V
Control Terminal Voltage	8 V	Lead Soldering Temperature (10 s)	235 °C
Reverse Bias Voltage	8 V		

TK70002 ELECTRICAL CHARACTERISTICS

Test conditions: $V_{IN} = 2.5 \text{ V}$, $T_A = 25 \text{ °C}$, unless otherwise specified.

SYMBOL	PARAMETER	TEST CONDITIONS	MIN	TYP	MAX	UNITS
I_Q	Quiescent Current	$I_{OUT} = 0 \text{ mA}$, Exclude I_{CONT}		0.25	0.65	mA
I_{STBY}	Standby Current	$V_{IN} = 8 \text{ V}$, Output OFF, $V_{CONT} = 0 \text{ V}$		0.5	100	nA
I_{OUT}	Output Current	$V_{DROP} = 0.5 \text{ V}$	70	110		mA
I_{GND}	Ground Current (Note 3)	$I_{OUT} = 50 \text{ mA}$		2.5	4.5	mA
V_{DROP}	Dropout Voltage	$I_{OUT} = 50 \text{ mA}$		0.18	0.35	V
ΔV_D	Balance Between Channels	V_{DROP} difference, $I_{OUT} = 50 \text{ mA}$		1	25	mV
I_{REV}	Reverse Bias Current	$V_{IN} = 0 \text{ V}$, $V_{REV} = 8 \text{ V}$, $V_{CONT} = 0 \text{ V}$		0.3	50	nA
ON/OFF CONTROL TERMINAL						
I_{CONT}	Control Terminal Current	$V_{CONT} = 1.6 \text{ V}$		7	15	μA
$V_{CONT(ON)}$	Control Voltage (ON)	Output ON	1.2			V
$V_{CONT(OFF)}$	Control Voltage (OFF)	Output OFF (Note 2)			0.3	V

Note 1: Power dissipation is 350 mW when mounted as recommended. Derate at 2.8 mW/°C for operation above 25 °C. Power dissipation is 150 mW in Free Air. Derate at 1.2 mW/°C for operation above 25 °C.

Note 2: By grounding this terminal, the operation completely stops and the input current decreases to a pA level.

Note 3: Ground current is defined as $I_{IN} - I_{OUT}$, excluding control current. Refer to "Definition of Terms."

Gen. Note: Parameters with min. or max. values are 100% tested.

Gen. Note: Exceeding the "Absolute Maximum Ratings" can damage the device.

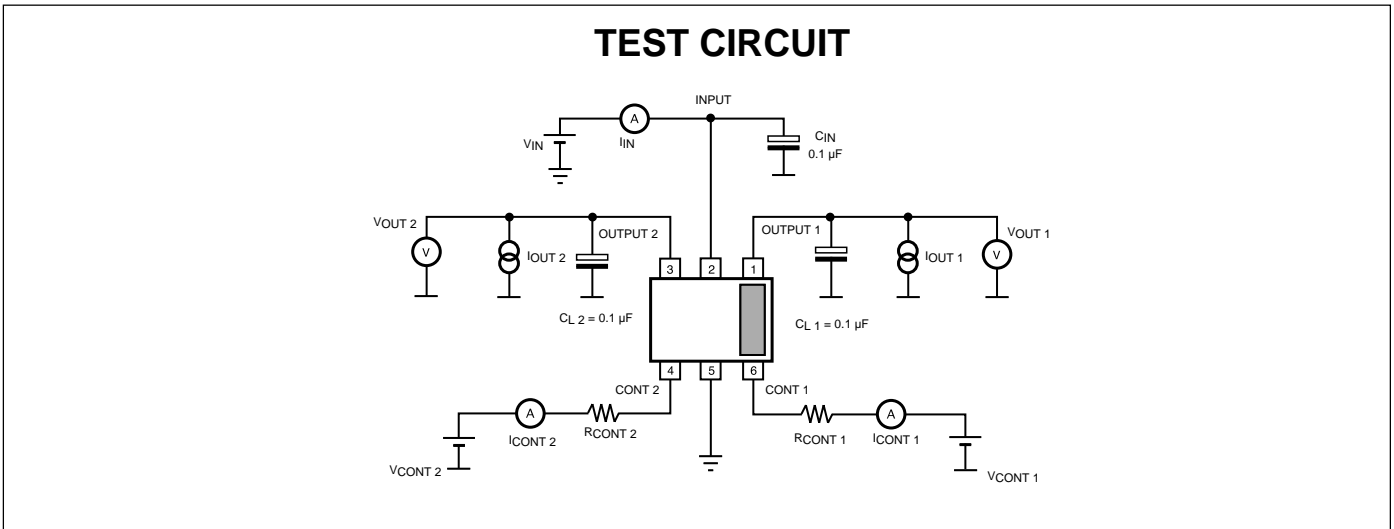

TYPICAL PERFORMANCE CHARACTERISTICS

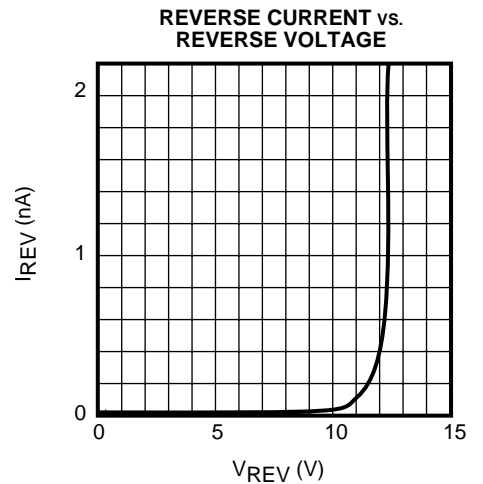
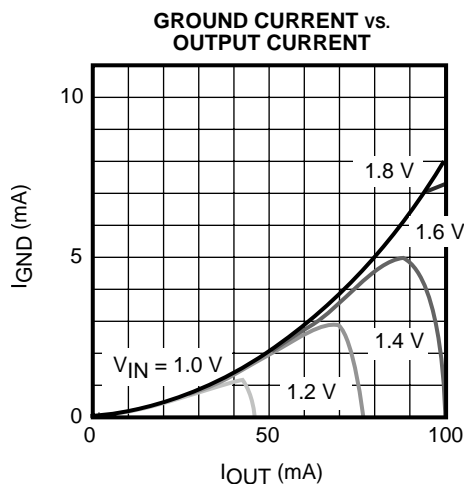
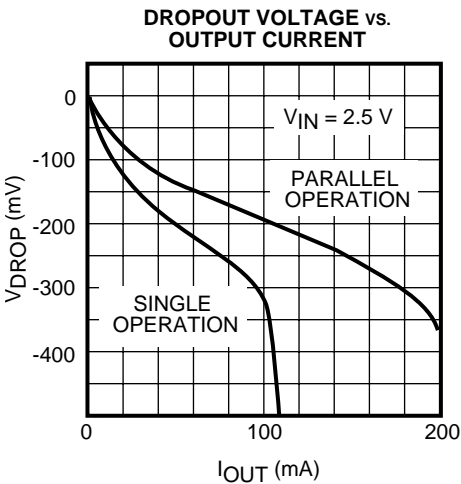
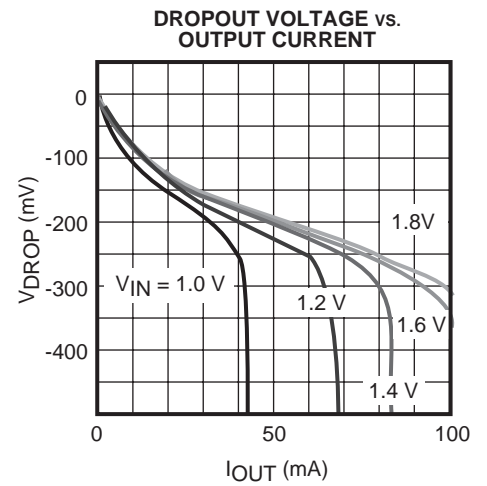
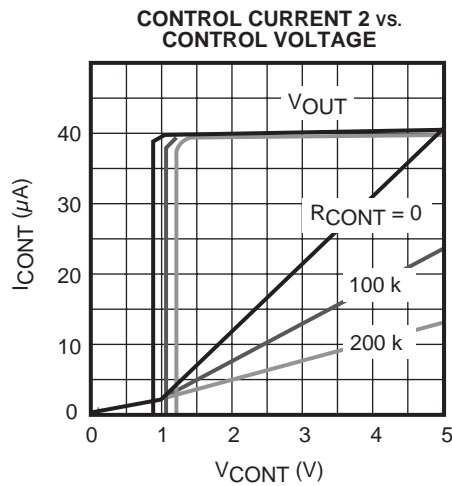
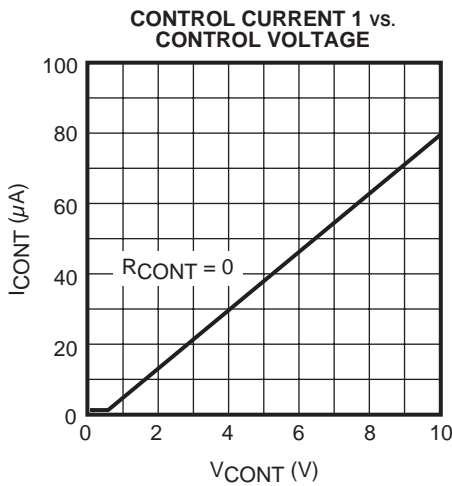

TYPICAL PERFORMANCE CHARACTERISTICS (CONT.)

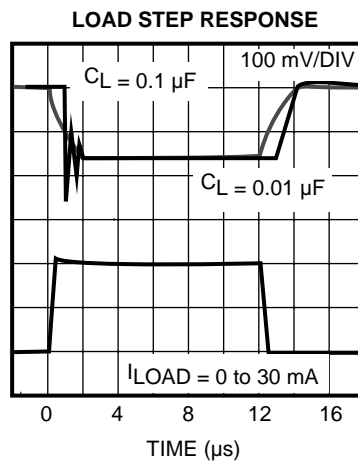
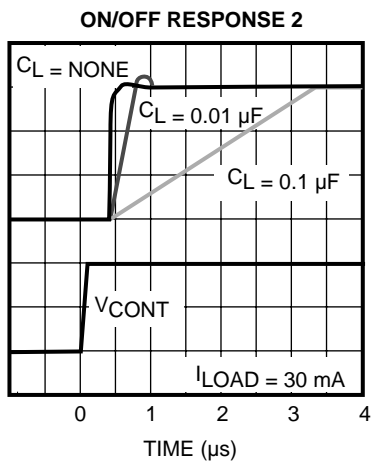
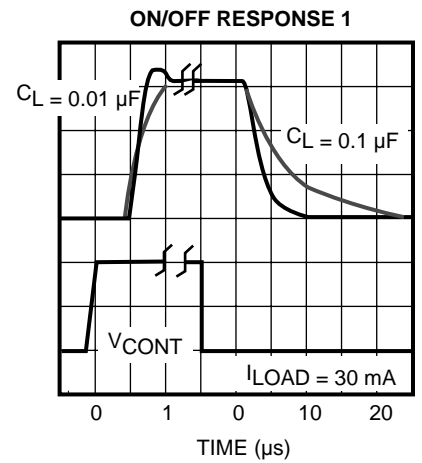
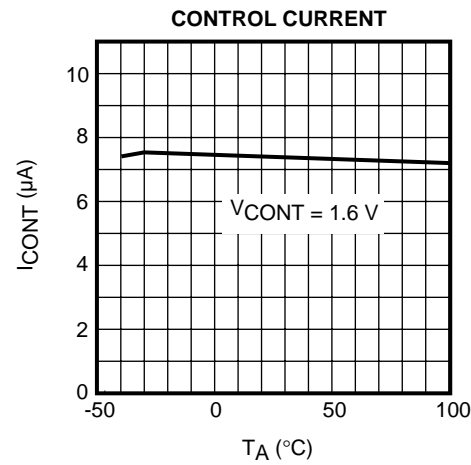
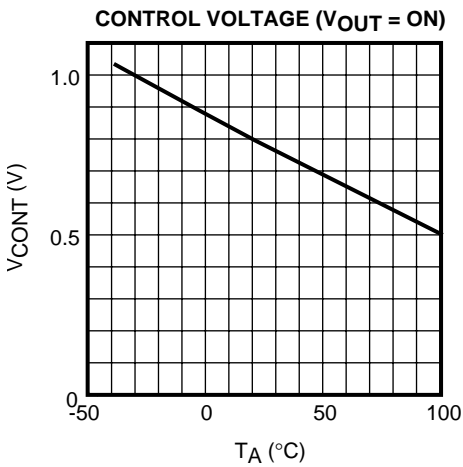
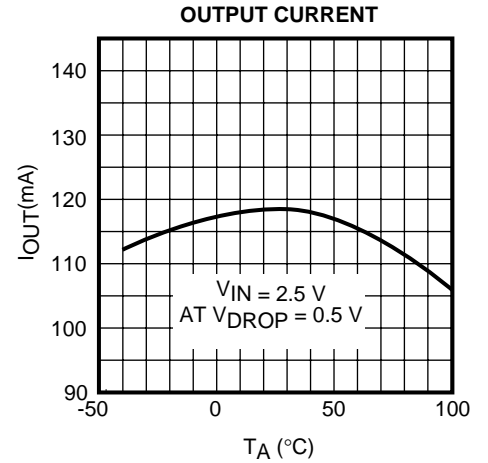
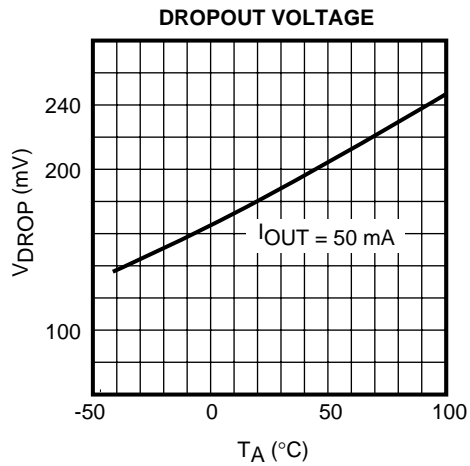
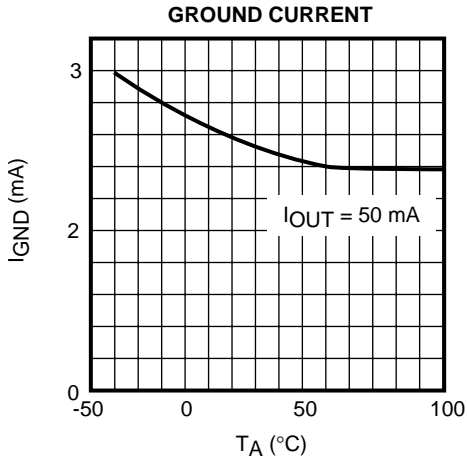

DEFINITION AND EXPLANATION OF TECHNICAL TERMS

DROPOUT VOLTAGE (V_{DROp})

The output voltage decreases with the increase of output current. It is dependent upon the load current and the junction temperature. It measures the differential voltage between the input voltage and the output voltage when the input voltage is set to 2.5 V and the output current is set to 50 mA.

OUTPUT CURRENT (I_{OUT})

The rated output current is specified under the condition where the output voltage drops 0.5 V below the no load value. The input voltage is set to 2.5 V, and the current is pulsed to minimize temperature effects.

QUIESCENT CURRENT (I_{Q})

The quiescent current is the current which flows through the ground terminal under no load conditions ($I_{\text{OUT}} = 0$ mA) with $V_{\text{IN}} = 2.5$ V and excludes the control pin current.

STANDBY CURRENT (I_{STBY})

Standby current is the current which flows into the solid state switch when the output is turned off by the control function ($V_{\text{CONT}} = 0$ V). It is measured with $V_{\text{IN}} = 8$ V.

GROUND CURRENT (I_{GND})

Ground current is the current which flows through the ground pin(s). It is defined as $I_{\text{IN}} - I_{\text{OUT}}$, excluding control current.

ON/OFF CONTROL

High is "on" (referenced to ground). The input current is at the pA level by connecting the control terminal to ground.

REVERSE VOLTAGE PROTECTION

Reverse voltage protection prevents damage due to the output voltage being higher than the input voltage. This fault condition can occur when the output capacitor remains charged and the input is reduced to zero, or when an external voltage higher than the input voltage is applied to the output side.

PACKAGE POWER DISSIPATION (P_{D})

This is the power dissipation level at which the thermal sensor is activated. The IC contains an internal thermal sensor which monitors the junction temperature. When the junction temperature exceeds the monitor threshold of 150 °C, the IC is shut down. The junction temperature rises as the difference between the input power ($V_{\text{IN}} \times I_{\text{IN}}$) and the output power ($V_{\text{OUT}} \times I_{\text{OUT}}$) increases. The rate of temperature rise is greatly affected by the mounting pad configuration on the PCB, the board material, and the ambient temperature. When the IC mounting has good thermal conductivity, the junction temperature will be low even if the power dissipation is great. When mounted on the recommended mounting pad, the power dissipation of the SOT-23-6 is increased to 350 mW. For operation at ambient temperatures over 25 °C, the power dissipation of the SOT-23-6 device should be derated at 2.8 mW/°C. To determine the power dissipation for shutdown when mounted, attach the device on the actual PCB and deliberately increase the output current (or raise the input voltage) until the thermal protection circuit is activated. Calculate the power dissipation of the device by subtracting the output power from the input power. These measurements should allow for the ambient temperature of the PCB. The value obtained from $P_{\text{D}} / (150\text{ °C} - T_{\text{A}})$ is the derating factor. The PCB mounting pad should provide maximum thermal conductivity in order to maintain low device temperatures. As a general rule, the lower the temperature, the better the reliability of the device. The thermal resistance when mounted is expressed as follows:

$$T_{\text{j}} = \theta_{\text{jA}} \times P_{\text{D}} + T_{\text{A}}$$

For Toko ICs, the internal limit for junction temperature is 150 °C. If the ambient temperature (T_{A}) is 25 °C, then:

$$150\text{ °C} = \theta_{\text{jA}} \times P_{\text{D}} + 25\text{ °C}$$

$$\theta_{\text{jA}} = 125\text{ °C} / P_{\text{D}}$$

P_{D} is the value when the thermal sensor is activated. A simple way to determine P_{D} is to calculate $V_{\text{IN}} \times I_{\text{IN}}$ when the output side is shorted. Input current gradually falls as temperature rises. You should use the value when thermal equilibrium is reached.

DEFINITIONS AND TERMS (CONT.)

The range of usable currents can also be found from the graph below.

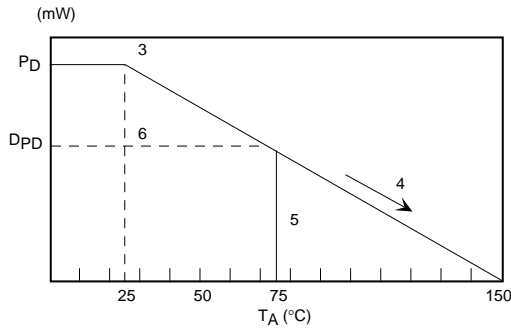

Procedure:

- 1) Find P_D
- 2) P_{D1} is taken to be $P_D \times (-0.8 - 0.9)$
- 3) Plot P_{D1} against 25 °C
- 4) Connect P_{D1} to the point corresponding to the 150 °C with a straight line.
- 5) In design, take a vertical line from the maximum operating temperature (e.g., 75 °C) to the derating curve.
- 6) Read off the value of P_D against the point at which the vertical line intersects the derating curve. This is taken as the maximum power dissipation, D_{PD} .

The maximum operating current is:

$$I_{OUT} = (D_{PD} / (V_{IN(MAX)} - V_{OUT}))$$

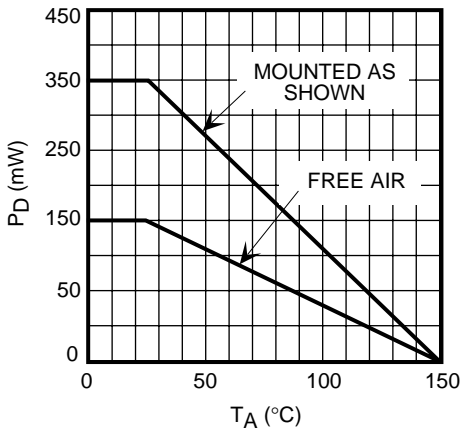

SOT-23-6 POWER DISSIPATION

APPLICATION INFORMATION

BOARD LAYOUT

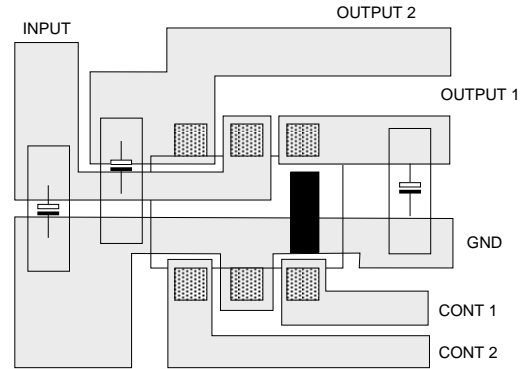

SOT-23-6 BOARD LAYOUT

PACKAGE OUTLINE

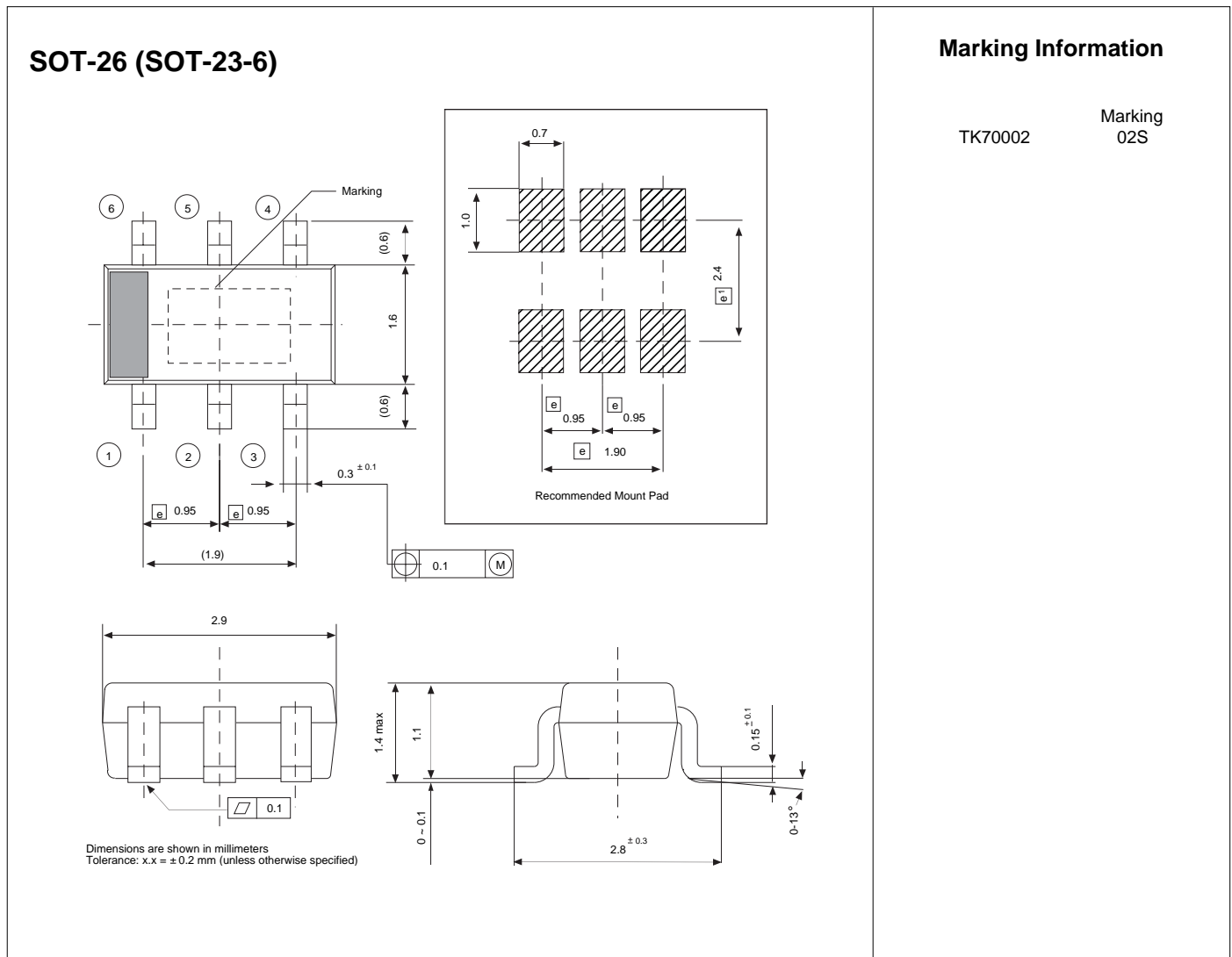

Toko America, Inc. Headquarters
1250 Feehanville Drive, Mount Prospect, Illinois 60056
Tel: (847) 297-0070 Fax: (847) 699-7864

TOKO AMERICA REGIONAL OFFICES

Midwest Regional Office
Toko America, Inc.
1250 Feehanville Drive
Mount Prospect, IL 60056
Tel: (847) 297-0070
Fax: (847) 699-7864

Western Regional Office
Toko America, Inc.
2480 North First Street, Suite 260
San Jose, CA 95131
Tel: (408) 432-8281
Fax: (408) 943-9790

Eastern Regional Office
Toko America, Inc.
107 Mill Plain Road
Danbury, CT 06811
Tel: (203) 748-6871
Fax: (203) 797-1223

Semiconductor Technical Support
Toko Design Center
4755 Forge Road
Colorado Springs, CO 80907
Tel: (719) 528-2200
Fax: (719) 528-2375

Visit our Internet site at <http://www.tokoam.com>

The information furnished by TOKO, Inc. is believed to be accurate and reliable. However, TOKO reserves the right to make changes or improvements in the design, specification or manufacture of its products without further notice. TOKO does not assume any liability arising from the application or use of any product or circuit described herein, nor for any infringements of patents or other rights of third parties which may result from the use of its products. No license is granted by implication or otherwise under any patent or patent rights of TOKO, Inc.