

TL1F2-NW0,L

LETERAS™

LETERAS™ is a trademark of TOSHIBA CORPORATION.

1. Applications

- General Lighting

2. Features

- (1) Size: 6.4 (L) mm × 5.0 (W) mm × 1.35 (H) mm
- (2) High luminous flux LED: 135 lm (typ.) @ $I_F = 350$ mA
- (3) Color: White (color temperature: 5000 K (typ.))
- (4) Operating temperature range: $T_{opr} = -40$ to 100 °C
- (5) Reflow-soldering is available.

3. Packaging and Pin Assignment

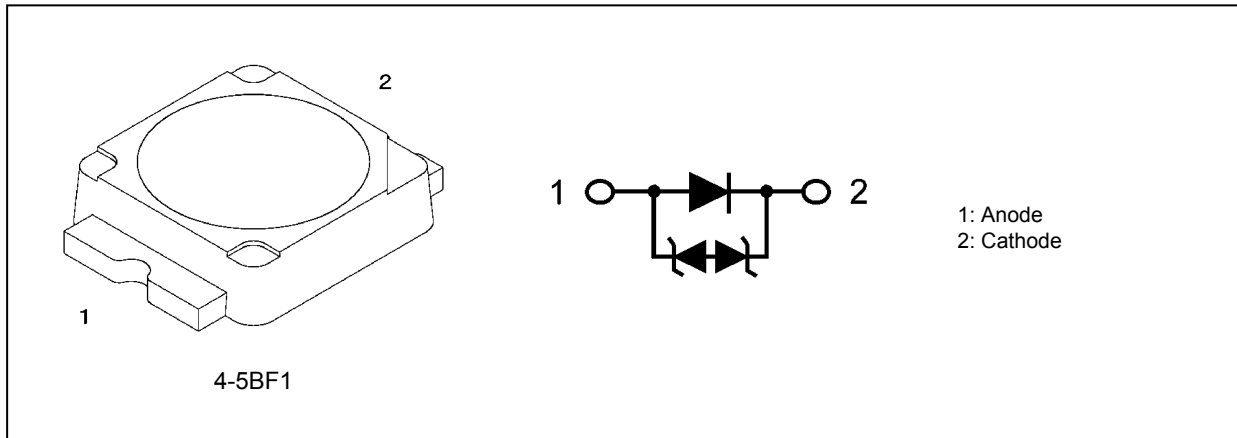

Start of commercial production

2014-02

4. Absolute Maximum Ratings (Note) (Unless otherwise specified, $T_a = 25\text{ }^\circ\text{C}$)

Characteristics	Symbol	Note	Rating	Unit
Forward current (DC) See Fig. 4.1.	I_F		550	mA
Forward current (pulsed)	I_{FP}	(Note 1)	600	
Power dissipation	P_D		1.9	W
Operating temperature	T_{opr}		-40 to 100	$^\circ\text{C}$
Storage temperature	T_{stg}		-40 to 100	
Junction temperature	T_j		130	

Note: Using continuously under heavy loads (e.g. the application of high temperature/current/voltage and the significant change in temperature, etc.) may cause this product to decrease in the reliability significantly even if the operating conditions (i.e. operating temperature/current/voltage, etc.) are within the absolute maximum ratings.

Please design the appropriate reliability upon reviewing the Toshiba Semiconductor Reliability Handbook ("Handling Precautions"/"Derating Concept and Methods") and individual reliability data (i.e. reliability test report and estimated failure rate, etc).

Note 1: Pulse width 10 ms, duty = 1/10

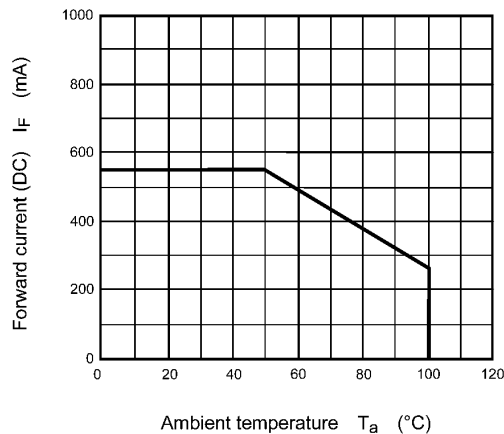

Fig. 4.1 $I_F - T_a$ (Note)

Note: The junction-to-ambient thermal resistance, $R_{th(j-a)}$, should be kept below $20\text{ }^\circ\text{C/W}$ so that this product is not exposed to a condition beyond the absolute maximum ratings.

$R_{th(j-a)}$: Thermal resistance from the LED junction to ambient temperature

5. Handling Precautions

- This product is sensitive to electrostatic and care must be fully taken when handling products. Particularly in the case that an overvoltage shall be applied, the overflowed energy may cause damage to or possibly result in destruction of the product. Users shall take absolutely secure countermeasures against electrostatic and surge when handling the product.
- A damage to the device might create a tiny leakage path, which causes the LED lamp not to light up in the low-current region or causes a drop in the VF rise voltage.
Failure criterion: $I_F > 0.5 \text{ mA @ } V_F = 2 \text{ V}$
- If multiple LEDs are connected in parallel, they will experience variations in the forward current due to the characteristics differences in forward voltage. Ensure that the forward current of all the LEDs fall within the intended range of the system design, for example, by inserting current-limiting resistors to each LED string.
- Since this product is intended to be used for display lighting, the measurement standard is based on the spectral sensitivity of the human eye. It is not intended to be used for any applications other than display lighting (e.g., sensors and light communications systems.)
- Generally, GaN-based LEDs exhibit instability or significant device-to-device variations in the relative luminous flux in the low-current region. To avoid these problems, an application system should be designed in such a manner that the GaN-based LEDs are driven with a forward current of 10 mA or higher.
- When the device is used in places that are likely to be exposed to condensation, salt or corrosive gas, the effect on its performance and reliability must be thoroughly verified.
- Please note the handling of products during evaluation.
 - (1) Please do not apply pressure to the upper surface of the product with finger, tweezers, and others.
Failure of product to light up may occur due to package deformation, wire deformation and/or disconnection.
 - (2) Should tweezers be used in product handling, one with flat surfaces is recommended.
 - (3) Please handle the product widthwise.
 - (4) Please do not drop the product. There is a possibility for package transformation etc. to occur when the product is dropped.
 - (5) Please do not stack the printed circuit boards on which the product is mounted to prevent damages to product surface. Also, please note not to damage the surface of the product with cushioning material etc. Surface damage to the product may influence their optical characteristics.
 - (6) Solder, flux, paper or heat-sensitive materials that might be deformed or discolored at high temperatures should not be left on the surface of an LED lamp.
- This product is used for a high-power driving application. It will be heated to a high temperature during operation (depending on operating power). Please be careful on the following points, when it is used (during operation).
 - (1) Please do not touch the product directly.
 - (2) Please use it in consideration of ambient temperature rise during operation, and temperature limit of components in a set, etc.

6. Electrical Characteristics (Unless otherwise specified, $T_a = 25\text{ }^\circ\text{C}$)

Characteristics	Symbol	Note	Test Condition	Min	Typ.	Max	Unit
Forward voltage See Table 6.1.	V_F		$I_F = 350\text{ mA}$	2.7	2.85	3.3	V
Reverse current	I_R		$V_R = 4\text{ V}$	—	—	100	μA
Thermal resistance (junction-to-soldering point)	$R_{th(j-s)}$	(Note 1)	$I_F = 350\text{ mA}$	—	8	—	$^\circ\text{C/W}$

Note 1: $R_{th(j-s)}$: Thermal resistance from the LED junction to solder point.

Table 6.1 Forward Voltage Rank (Note)

Rank	Test Condition	Forward Voltage (Min)	Forward Voltage (Max)	Unit
1	$I_F = 350\text{ mA}$, $T_a = 25\text{ }^\circ\text{C}$, Tolerance $\pm 0.1\text{ V}$	2.7	2.9	V
2		2.9	3.1	
3		3.1	3.3	

Note: This LED lamp is sorted into forward voltage (V_F) ranks shown above. Each reel includes the same rank LEDs. Let the delivery ratio of each rank be unquestioned.

7. Optical Characteristics (Unless otherwise specified, $T_a = 25\text{ }^\circ\text{C}$)

Characteristics	Symbol	Note	Test Condition	Min	Typ.	Max	Unit
Chromaticity	C_x	(Note 1)	$I_F = 350\text{ mA}$	—	—	—	—
	C_y	(Note 1)	$I_F = 350\text{ mA}$	—	—	—	—
Luminous flux	ϕ_v	(Note 2)	$I_F = 350\text{ mA}$	120	135	145	lm
Color temperature	CCT		$I_F = 350\text{ mA}$	—	5000	—	K
Color rendering index	Ra	(Note 3)	$I_F = 350\text{ mA}$	70	—	—	—
Half-intensity angle	$2\theta_{1/2}$		$I_F = 350\text{ mA}$	—	120	—	$^\circ$

Note 1: See Fig. 7.1 and Table 7.1 for chromaticity rank.

Note 2: See Table 7.2 for luminous flux rank.

Note 3: Tolerance: ± 2

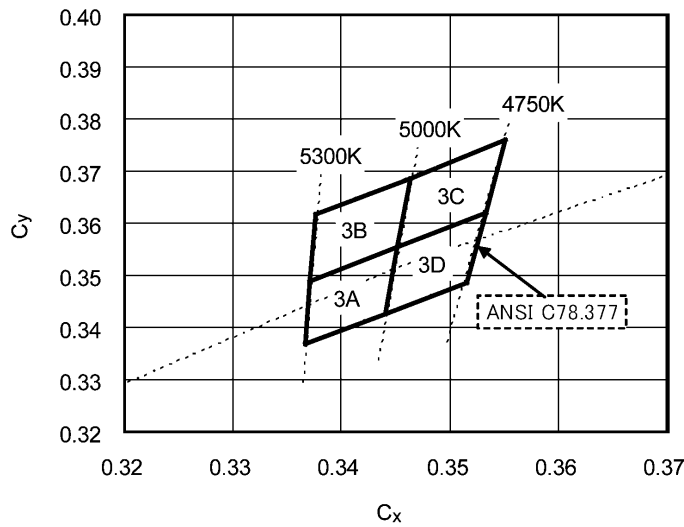

Fig. 7.1 Chromaticity Rank (Note)

Note: Test conditions: $I_F = 350 \text{ mA}$, $T_a = 25 \text{ }^\circ\text{C}$, Tolerance: ± 0.01

Table 7.1 Chromaticity Rank (Note)

Rank	C_x	C_y	Rank	C_x	C_y
3A	0.3371	0.3490	3C	0.3463	0.3687
	0.3451	0.3554		0.3551	0.3760
	0.3440	0.3427		0.3533	0.3620
	0.3366	0.3369		0.3451	0.3554
3B	0.3376	0.3616	3D	0.3451	0.3554
	0.3463	0.3687		0.3533	0.3620
	0.3451	0.3554		0.3515	0.3487
	0.3371	0.3490		0.3440	0.3427

Note: This LED lamp is sorted into chromaticity coordinate groups shown above. Each reel includes the same rank LEDs. Let the delivery ratio of each rank be unquestioned.

Table 7.2 Luminous Flux Rank (Note)

Rank	Test Condition	Luminous Flux (Min)	Luminous Flux (Max)	Unit
B12A	$I_F = 350 \text{ mA}$, $T_a = 25 \text{ }^\circ\text{C}$, Tolerance $\pm 10 \%$	120	125	lm
B12B		125	130	
B13A		130	135	
B13B		135	140	
B14A		140	145	

Note: This LED lamp is sorted into luminous flux ranks shown above. Each reel includes the same rank LEDs. Let the delivery ratio of each rank be unquestioned.

Rank notations: The luminous flux, chromaticity and V_F ranks are printed on labels as shown below:

- Example: 3A B13A 2
- 3A: Chromaticity rank
- B13A: Luminous flux rank
- 2: V_F rank

8. Characteristics Curves (Note)

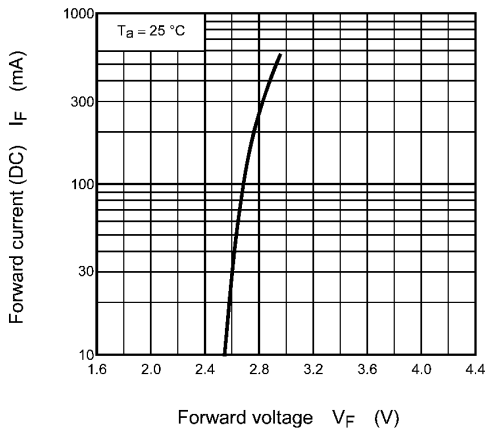

Fig. 8.1 $I_F - V_F$

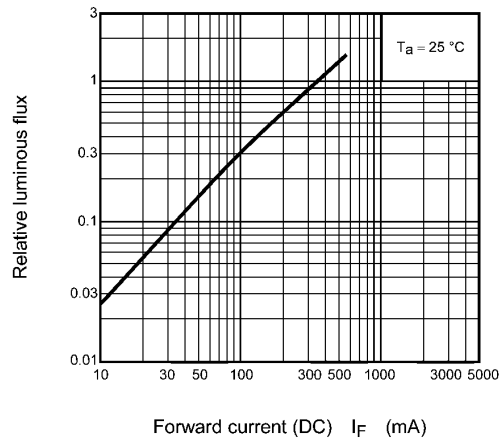

Fig. 8.2 Relative Luminous Flux - I_F

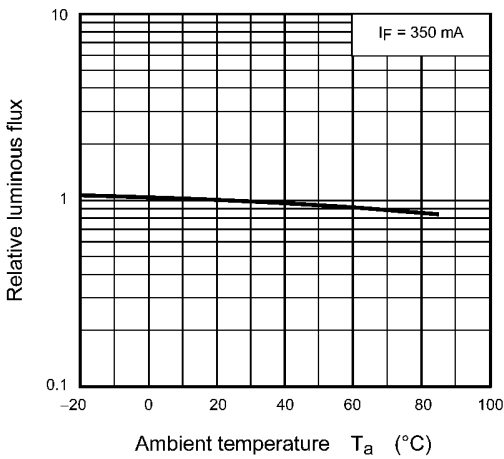

Fig. 8.3 Relative Luminous Flux - T_a

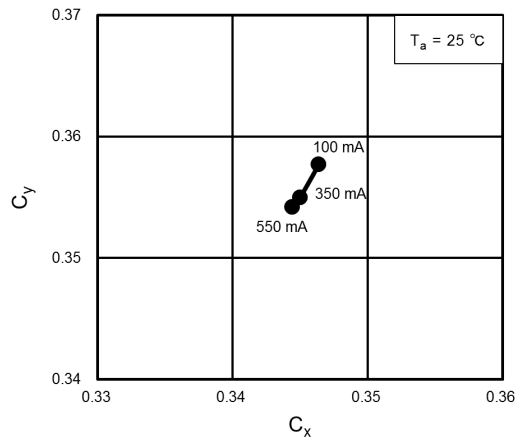

Fig. 8.4 Chromaticity - I_F

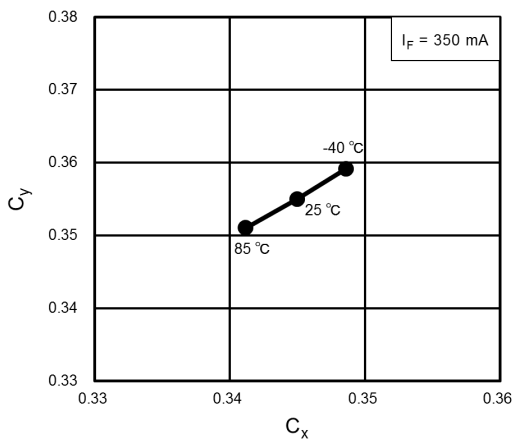

Fig. 8.5 Chromaticity - I_F

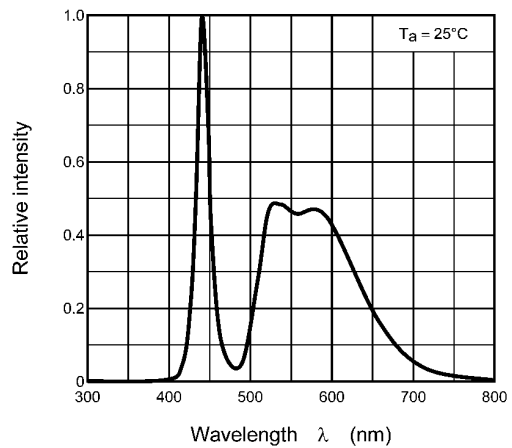

Fig. 8.6 Wavelength Characteristic

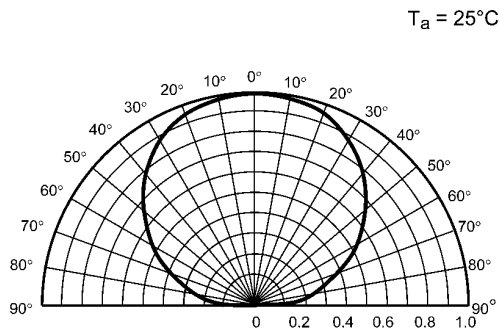

Fig. 8.7 Radiation Pattern

Note: The above characteristics curves are presented for reference only and not guaranteed by production test, unless otherwise noted.

9. Packing

9.1. Moisture-Proof Packing

These LED devices are packed in an aluminum envelope with a silica gel and a moisture indicator to avoid moisture absorption. The optical characteristics of the device may be affected by exposure to moisture in the air before soldering and the device should therefore be stored under the following conditions:

- This moisture proof bag may be stored unopened within 12 months at the following conditions.
Temperature: 5 °C to 30 °C
Humidity: 90 % (max)
- After opening the moisture proof bag, the device should be assembled within 4 weeks in an environment of 5 °C to 30 °C/60 % RH or below.
- If upon opening, the moisture indicator card shows humidity 30 % or above (Color of indication changes to pink) or the expiration date has passed, the device should be baked in taping with reel.
After baking, use the baked device within 72 hours, but perform baking only once.
Baking conditions: 60 ± 5 °C, for 12 to 24 hours.
Expiration date: 12 months from sealing date, which is imprinted on the label affixed.
- Repeated baking can cause the peeling strength of the taping to change, then leads to trouble in mounting. Furthermore, prevent the devices from being destructed against static electricity for baking of it.
- If the packing material of laminate would be broken, the hermeticity would deteriorate. Therefore, do not throw or drop the packed devices.

10. Mounting

10.1. Mounting Precautions

- Do not apply mechanical stress to the resin body at high temperature.
The time taken for a device to return to the room temperature after reflow soldering depends on the mounting board and environmental conditions.
- The resin body is easily scratched. Avoid friction against hard materials.
- When installing an assembled board into equipment, ensure that the devices on the board do not contact with other components.

10.2. Soldering

Following show examples of reflow soldering.

- Temperature Profile (see following figures.)

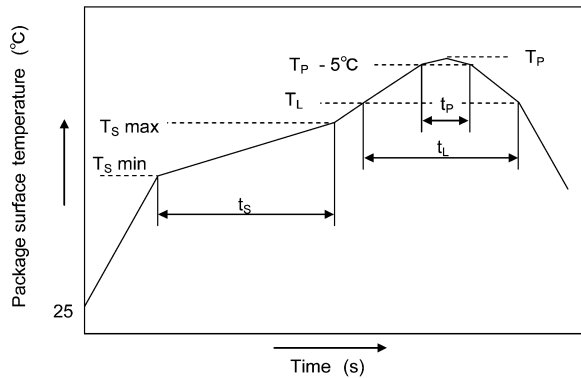

Fig. 10.2.1 Temperature Profile for Lead(Pb)-free Soldering (example)

	Symbol	Min	Max	Unit
Ramp-up rate (25 to 150°C)		1	3	°C/s
Preheat temperature	T_s	150	200	°C
Preheat time	t_s	60	120	s
Ramp-up rate (T_L to T_P)		1	3	°C/s
Liquidous temperature	T_L	217		°C
Time above T_L	t_L	60	100	s
Peak temperature	T_P		260	°C
Time within 5°C of actual peak temperature	t_p		30	s
Ramp-down rate (T_P to T_L)			6	°C/s

Table 10.2.1 Temperature Profile for Lead(Pb)-free Soldering (example)

- The product is evaluated using above reflow soldering conditions. No additional test is performed exceed the condition as a evaluation. Please perform reflow soldering under the above conditions.
- Please perform the first reflow soldering with reference to the above temperature profile and within 4 weeks of opening the package.
- If a second reflow process is necessary, reflow soldering should be performed within 168 h of the first reflow under the above conditions. Storage conditions before the second reflow soldering: 30 °C, 60 % RH (max)
- Do not perform wave soldering.
- When any soldering corrections are made manually, a hot-plate should be used. (only once at each soldering point)

10.3. Land Pattern Dimensions (for reference only)

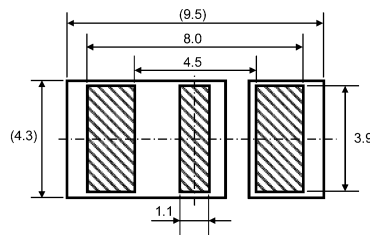

Fig. 10.3.1 (Unit: mm)

11. Cleaning

- Flux cleaning should be completed free of residual reactive ion such as Na, Cl, etc. Organic solvent acts upon water and generates corrosive gas such as hydrogen chloride. There are some cases where the device is degraded.
- Effective solvent seriously affects package and resin, and may cause inferior device. In actually using it, please sufficiently check whether there is nothing inferior on the device.
- Ultrasonic cleaning that provides effective cleaning for short time much affects on the device. so coherence between resin and lead metal is degraded by cleaning solvent during long ultrasonic cleaning. We recommend to take ultrasonic cleaning for the device at a minimum range. The influences on a device is occurred by the output of an ultrasonic wave and set board, please sufficiently check whether there is nothing inferior on the device.

12. Tape Specifications

12.1. Product Naming Conventions

The type of package used for shipment is denoted by a symbol suffix after the part number. The method of classification is as below. (this method, however does not apply to products whose electrical characteristics differ from standard Toshiba specifications)

Example: TL1F2-NW0,L

Toshiba part number: TL1F2-NW0

Packing type: L (Taping)

12.2. Handling Precautions

- (1) The tape is antistatic-coated. However, if the tape is charged with excess static electricity, devices might cling to the tape or wobble in the tape when the cover tape peeled off. Be aware of the following to avoid this:
 - Use an ionizer to neutralize the ions when utilizing an automatic mounter.
 - For transport and temporary storage of devices, use containers (boxes, jigs, bags) that are made with antistatic materials or materials that dissipate static electricity.

12.3. Tape Dimensions

Table 12.3.1 Tape Dimensions (Unit: mm)

	D	E	P ₀	t	F	D ₁	P ₂	W	P	A ₀	B ₀	K ₀
Dimensions	1.5	1.75	4.0	0.25	5.5	1.7	2.0	12.0	8.0	6.8	5.4	1.55
Tolerance	+0.1/-0	±0.1	±0.1	±0.05	±0.05	±0.1	±0.05	±0.2	±0.1	±0.1	±0.1	±0.1

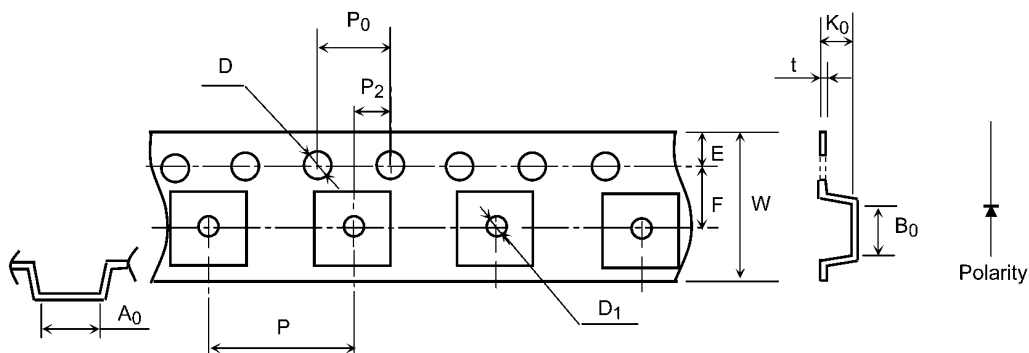

12.4. Reel Specification

12.4.1. Reel Dimensions

Unit: mm

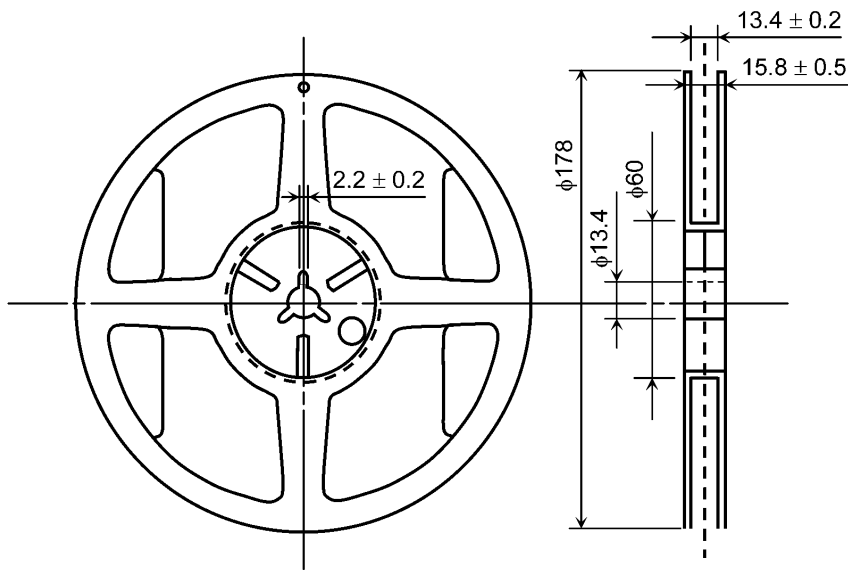

12.4.2. Tape Leader and Trailer

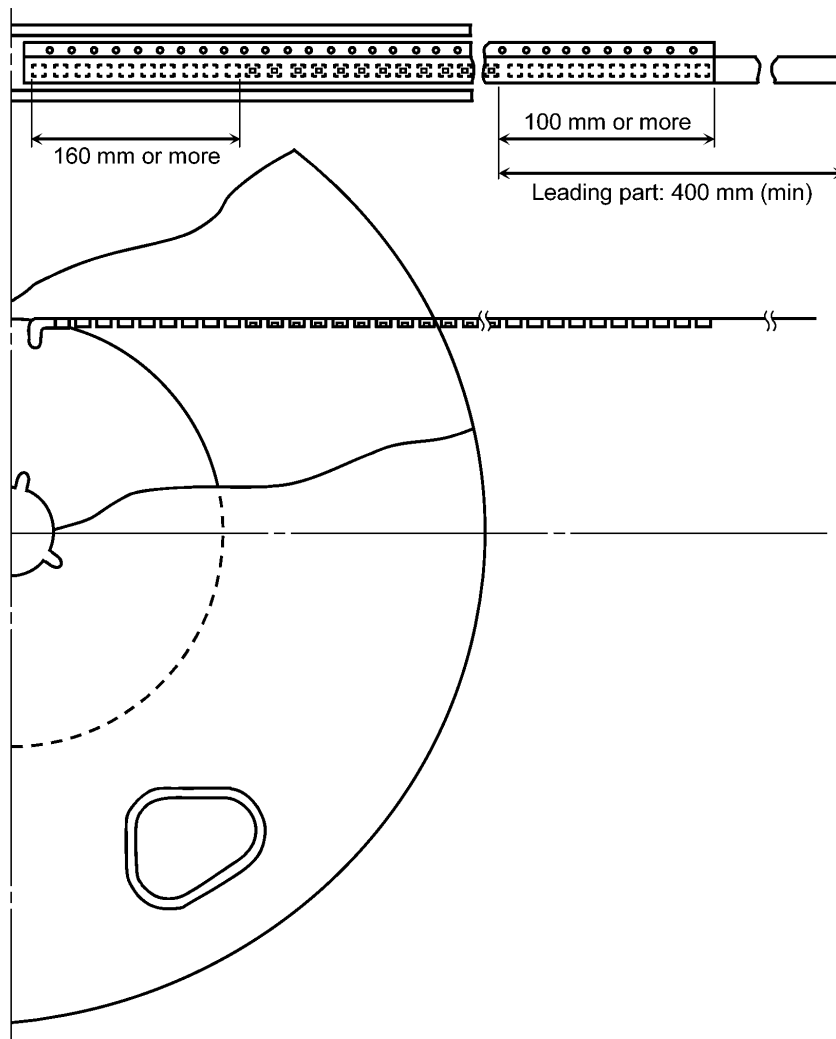

12.5. Packing Form

Each reel is sealed in an aluminum pack with silica gel. Packing quantity is as shown below.

- Reel: 1,000 pcs
- Carton: 4,000 pcs
- Sealed aluminum pack with silica gel

12.6. Label Format

Label example for TL1F2-NW0,L and label location are as shown below.

12.6.1. Label Example

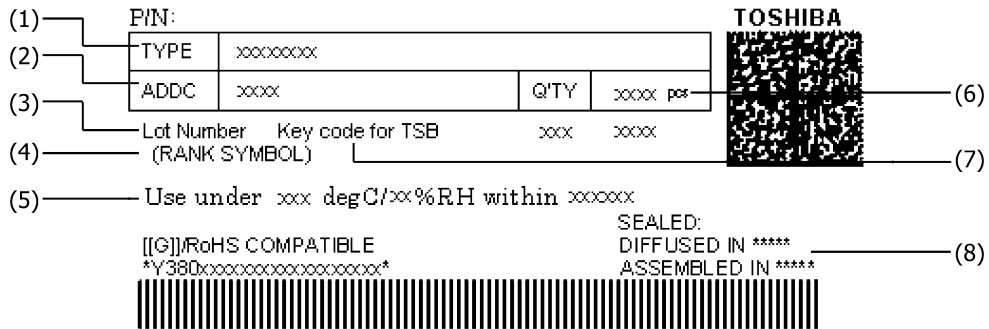

12.6.2. Label Details

No. (# refer to the above label example)	Information for Toshiba Use	Remarks
(1)	Part No.	TL1F2-NW0,L
(2)	ADD code	—
(3)	Lot code	Example: 270xxxxx
(4)	Rank symbol	Example: 3AB13A2
(5)	Storage condition after opening	Use under 5 - 30 °C/60 %RH within 4 weeks
(6)	Packing quantity	Example: 1,000 pcs
(7)	Key code	Example: 12345
(8)	Country of origin	Example: CHINA

12.6.3. Label Location

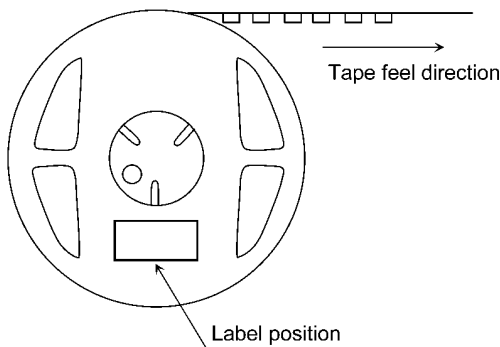

Fig. 12.6.3.1 Label Position on the Reel

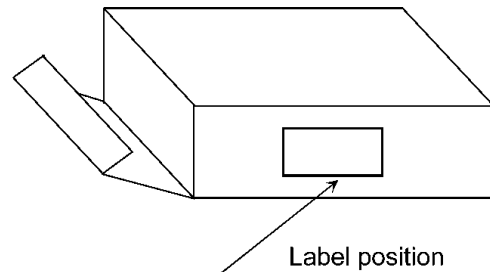
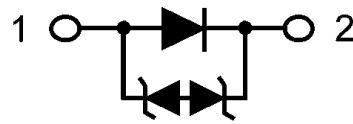

Fig. 12.6.3.2 Label Position on the Carton

Aluminum pack : The aluminum pack in which the reel is supplied also has the label attached to center of one side.

13. Internal Circuit



1: Anode
2: Cathode

Package Dimensions

Unit: mm

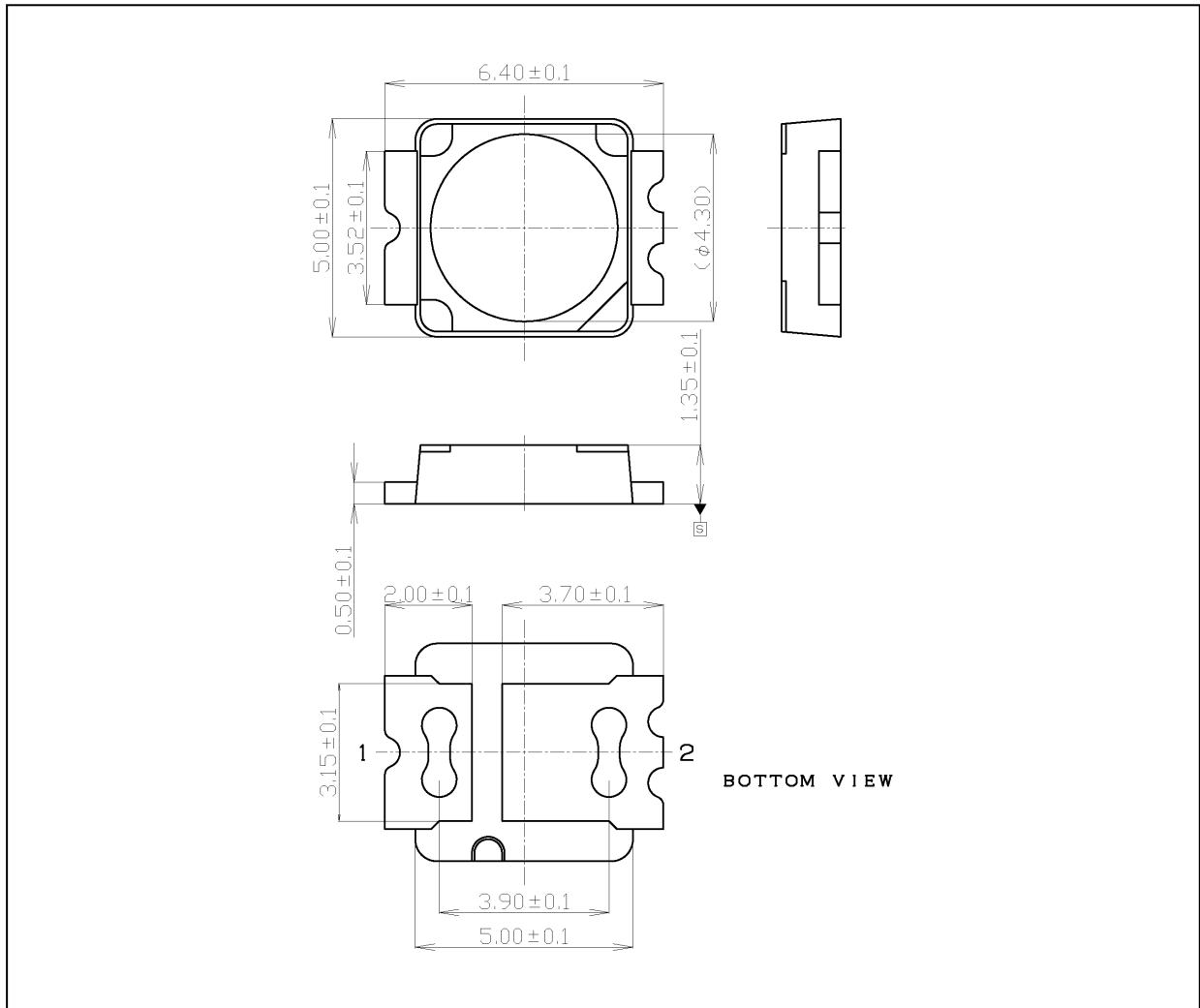

Weight: 0.11 g (typ.)

Package Name(s)
TOSHIBA: 4-5BF1

RESTRICTIONS ON PRODUCT USE

- Toshiba Corporation, and its subsidiaries and affiliates (collectively "TOSHIBA"), reserve the right to make changes to the information in this document, and related hardware, software and systems (collectively "Product") without notice.
- This document and any information herein may not be reproduced without prior written permission from TOSHIBA. Even with TOSHIBA's written permission, reproduction is permissible only if reproduction is without alteration/omission.
- Though TOSHIBA works continually to improve Product's quality and reliability, Product can malfunction or fail. Customers are responsible for complying with safety standards and for providing adequate designs and safeguards for their hardware, software and systems which minimize risk and avoid situations in which a malfunction or failure of Product could cause loss of human life, bodily injury or damage to property, including data loss or corruption. Before customers use the Product, create designs including the Product, or incorporate the Product into their own applications, customers must also refer to and comply with (a) the latest versions of all relevant TOSHIBA information, including without limitation, this document, the specifications, the data sheets and application notes for Product and the precautions and conditions set forth in the "TOSHIBA Semiconductor Reliability Handbook" and (b) the instructions for the application with which the Product will be used with or for. Customers are solely responsible for all aspects of their own product design or applications, including but not limited to (a) determining the appropriateness of the use of this Product in such design or applications; (b) evaluating and determining the applicability of any information contained in this document, or in charts, diagrams, programs, algorithms, sample application circuits, or any other referenced documents; and (c) validating all operating parameters for such designs and applications. **TOSHIBA ASSUMES NO LIABILITY FOR CUSTOMERS' PRODUCT DESIGN OR APPLICATIONS.**
- **PRODUCT IS NEITHER INTENDED NOR WARRANTED FOR USE IN EQUIPMENTS OR SYSTEMS THAT REQUIRE EXTRAORDINARILY HIGH LEVELS OF QUALITY AND/OR RELIABILITY, AND/OR A MALFUNCTION OR FAILURE OF WHICH MAY CAUSE LOSS OF HUMAN LIFE, BODILY INJURY, SERIOUS PROPERTY DAMAGE AND/OR SERIOUS PUBLIC IMPACT ("UNINTENDED USE").** Except for specific applications as expressly stated in this document, Unintended Use includes, without limitation, equipment used in nuclear facilities, equipment used in the aerospace industry, medical equipment, equipment used for automobiles, trains, ships and other transportation, traffic signaling equipment, equipment used to control combustions or explosions, safety devices, elevators and escalators, devices related to electric power, and equipment used in finance-related fields. **IF YOU USE PRODUCT FOR UNINTENDED USE, TOSHIBA ASSUMES NO LIABILITY FOR PRODUCT.** For details, please contact your TOSHIBA sales representative.
- Do not disassemble, analyze, reverse-engineer, alter, modify, translate or copy Product, whether in whole or in part.
- Product shall not be used for or incorporated into any products or systems whose manufacture, use, or sale is prohibited under any applicable laws or regulations.
- The information contained herein is presented only as guidance for Product use. No responsibility is assumed by TOSHIBA for any infringement of patents or any other intellectual property rights of third parties that may result from the use of Product. No license to any intellectual property right is granted by this document, whether express or implied, by estoppel or otherwise.
- **ABSENT A WRITTEN SIGNED AGREEMENT, EXCEPT AS PROVIDED IN THE RELEVANT TERMS AND CONDITIONS OF SALE FOR PRODUCT, AND TO THE MAXIMUM EXTENT ALLOWABLE BY LAW, TOSHIBA (1) ASSUMES NO LIABILITY WHATSOEVER, INCLUDING WITHOUT LIMITATION, INDIRECT, CONSEQUENTIAL, SPECIAL, OR INCIDENTAL DAMAGES OR LOSS, INCLUDING WITHOUT LIMITATION, LOSS OF PROFITS, LOSS OF OPPORTUNITIES, BUSINESS INTERRUPTION AND LOSS OF DATA, AND (2) DISCLAIMS ANY AND ALL EXPRESS OR IMPLIED WARRANTIES AND CONDITIONS RELATED TO SALE, USE OF PRODUCT, OR INFORMATION, INCLUDING WARRANTIES OR CONDITIONS OF MERCHANTABILITY, FITNESS FOR A PARTICULAR PURPOSE, ACCURACY OF INFORMATION, OR NONINFRINGEMENT.**
- Do not use or otherwise make available Product or related software or technology for any military purposes, including without limitation, for the design, development, use, stockpiling or manufacturing of nuclear, chemical, or biological weapons or missile technology products (mass destruction weapons). Product and related software and technology may be controlled under the applicable export laws and regulations including, without limitation, the Japanese Foreign Exchange and Foreign Trade Law and the U.S. Export Administration Regulations. Export and re-export of Product or related software or technology are strictly prohibited except in compliance with all applicable export laws and regulations.
- Please contact your TOSHIBA sales representative for details as to environmental matters such as the RoHS compatibility of Product. Please use Product in compliance with all applicable laws and regulations that regulate the inclusion or use of controlled substances, including without limitation, the EU RoHS Directive. **TOSHIBA ASSUMES NO LIABILITY FOR DAMAGES OR LOSSES OCCURRING AS A RESULT OF NONCOMPLIANCE WITH APPLICABLE LAWS AND REGULATIONS.**