

# TL3240 SERIES TACT SWITCH

ANTI-VANDAL SWITCHES  
 DETECTOR SWITCHES  
 DIP SWITCHES  
 KEYLOCK SWITCHES  
 NAVIGATION SWITCHES  
 PUSHBUTTON SWITCHES  
 ROCKER SWITCHES  
 ROTARY SWITCHES  
 SLIDE SWITCHES  
 SNAP ACTION SWITCHES  
**TACTILE SWITCHES**  
 TOGGLE SWITCHES  
 CAP OPTIONS

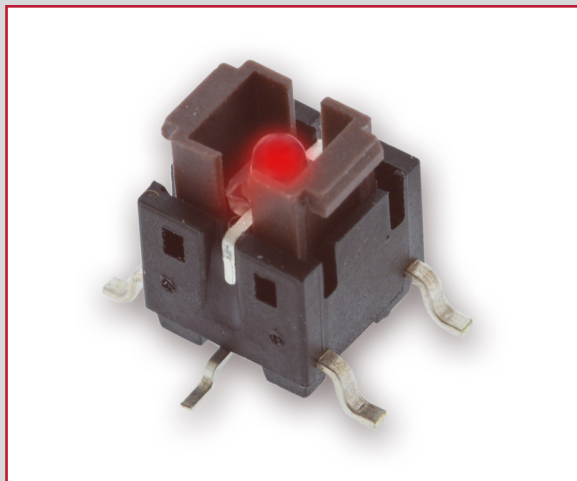

## APPLICATIONS / MARKETS

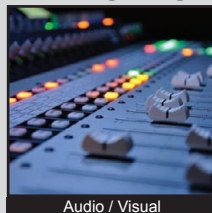

Audio / Visual

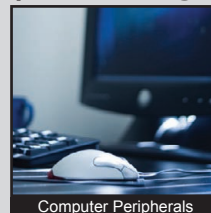

Computer Peripherals

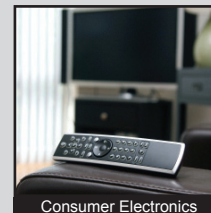

Consumer Electronics

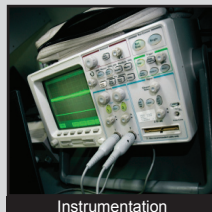

Instrumentation



Telecommunication



Medical Equipment

# RoHS

## SPECIFICATIONS

**Electrical Rating:** 50mA @ 12VDC  
**Life Expectancy:** 200,000 Cycles  
**Contact Resistance:** 100mΩ Max.  
**Insulation Resistance:** 100 MΩ Min. at 500VDC  
**Dielectric Strength:** 250VAC for 1 min.  
**Operating Temperature:** -25°C to 70°C  
**Storage Temperature:** -30°C to 80°C  
**Operating Force:** 100 gf +/- 50 gf; 160 gf +/- 50 gf;  
 260 gf +/- 50 gf  
**Travel:** 0.2mm +/- 0.1mm  
**Contact Arrangement:** SPST, Normally Open

## FEATURES & BENEFITS

- Illumination options
- Tape & Reel packaging: 450 pieces per reel
- Caps sold separately
- Surface Mount

## PART NUMBER CONFIGURATOR

Series	Model	Force	LED	Cap*	Cap Color
TL	3240	F100 - 100 gf F160 - 160 gf F260 - 260 gf	B - Blue R - Red G - Green Y - Yellow	TL3240R1CAP TL3240S1CAP	BLK - Black RED - Red BLU - Blue IVR - Ivory GRN - Green YEL - Yellow

\* Cap to be ordered separately. *They cannot go thru the reflow soldering process.*

*Specifications subject to change without notice*



**E-SWITCH®**

www.e-switch.com

800.867.2717

2

# TL3240 SERIES TACT SWITCH

## BODY DIMENSIONS

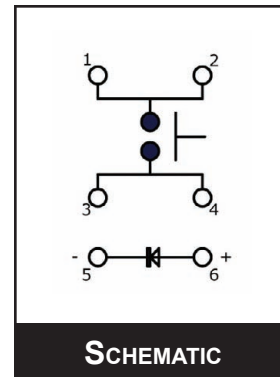
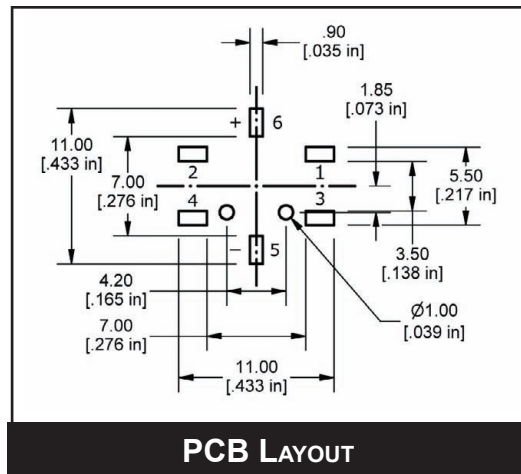
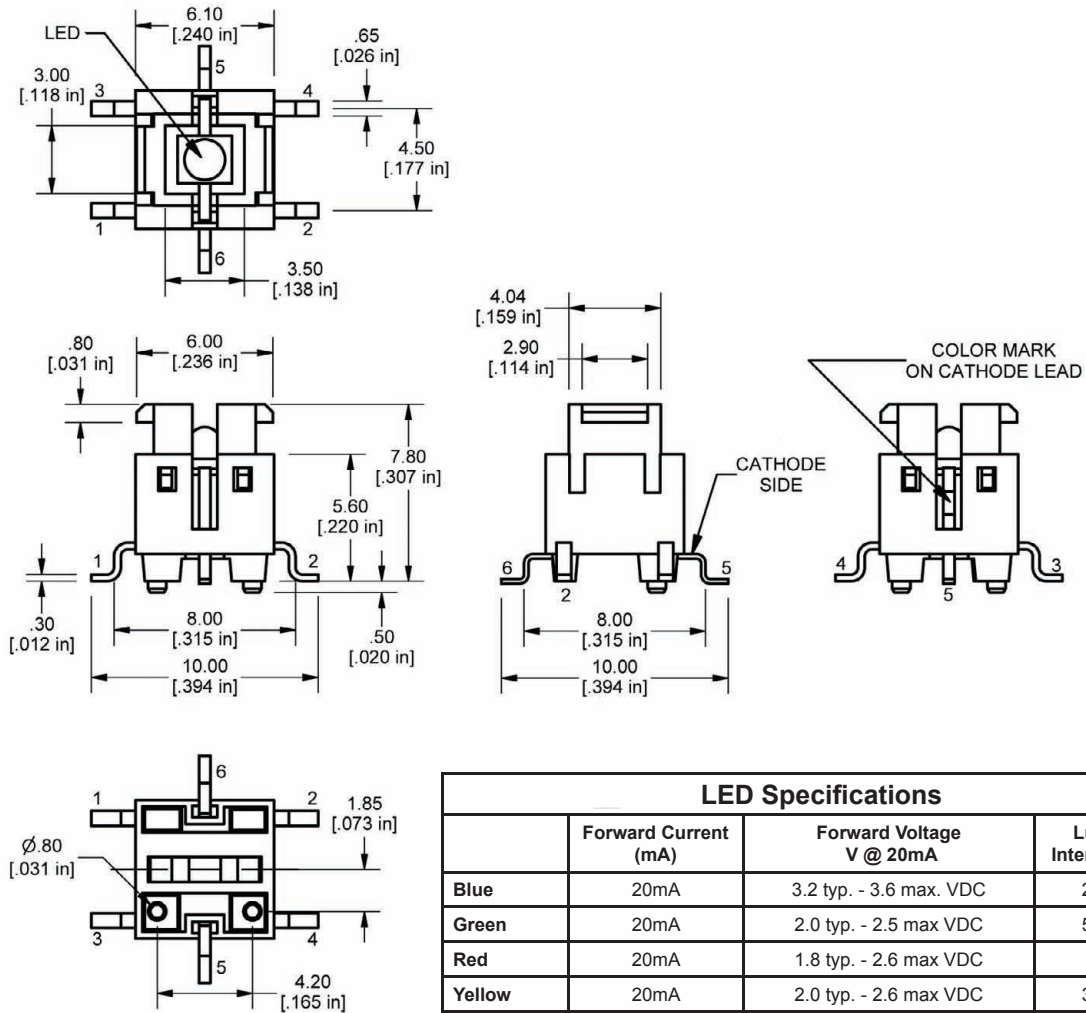

ANTI-VANDAL SWITCHES  
 DETECTOR SWITCHES  
 DIP SWITCHES  
 KEYLOCK SWITCHES  
 NAVIGATION SWITCHES  
 PUSHBUTTON SWITCHES  
 ROCKER SWITCHES  
 ROTARY SWITCHES  
 SLIDE SWITCHES  
 SNAP ACTION SWITCHES  
 TACTILE SWITCHES  
 TOGGLE SWITCHES  
 CAP OPTIONS