

TL3750 SERIES TACT SWITCH

ANTI-VANDAL SWITCHES
 DETECTOR SWITCHES
 DIP SWITCHES
 KEYLOCK SWITCHES
 NAVIGATION SWITCHES
 PUSHBUTTON SWITCHES
 ROCKER SWITCHES
 ROTARY SWITCHES
 SLIDE SWITCHES
 SNAP ACTION SWITCHES
TACTILE SWITCHES
 TOGGLE SWITCHES
 CAP OPTIONS

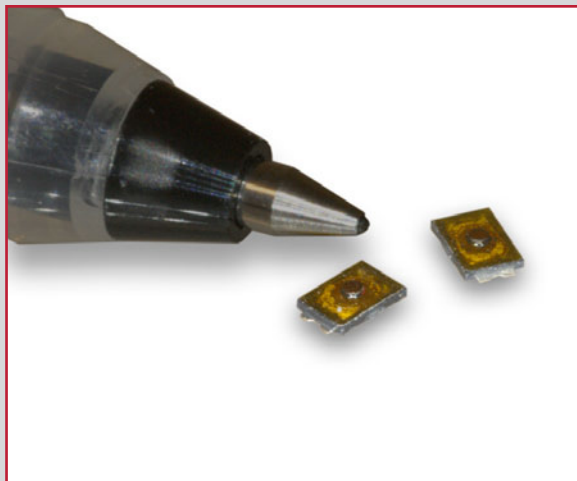

APPLICATIONS / MARKETS



Wearable Electronics

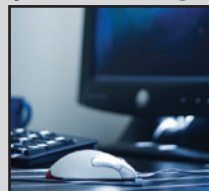

Computer Peripherals



Consumer Electronics

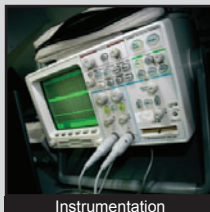

Instrumentation



Telecommunication

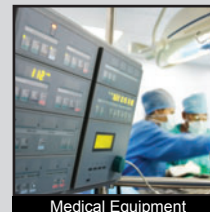

Medical Equipment

RoHS

SPECIFICATIONS

Electrical Rating: 50mA @ 12VDC
Electrical Life: 300,000 Cycles
Mechanical Life: 300,000 Cycles
Contact Resistance: 500mΩ Max. initial
Insulation Resistance: 100M Ω at 100VDC
Dielectric Strength: 100VAC for 1 min.
Operating Temperature: -30°C to 85°C
Storage Temperature: -40°C to 90°C
Operating Force: 100, 180, 240 gf
Travel: 0.13mm
Contact Arrangement: SPST

FEATURES & BENEFITS

- Ultra-miniature - 2.0mm x 3.0mm
- Surface mount termination
- Very low profile - 0.58mm

PART NUMBER CONFIGURATOR

Series	Model	Actuator Option	Actuation Force	Contact Material	Termination
<input type="text" value="TL"/>	<input type="text" value="3750"/>	<input type="text" value="A - 0.58mm"/>	<input type="text" value="F100 - 100 gf"/> <input type="text" value="F180 - 180 gf"/> <input type="text" value="F240 - 240 gf"/>	<input type="text" value="Q - Silver"/>	<input type="text" value="G - Gullwing"/>

Specifications subject to change without notice



E-SWITCH®

www.e-switch.com

800.867.2717

2

TL3750 SERIES TACT SWITCH

BODY DIMENSIONS

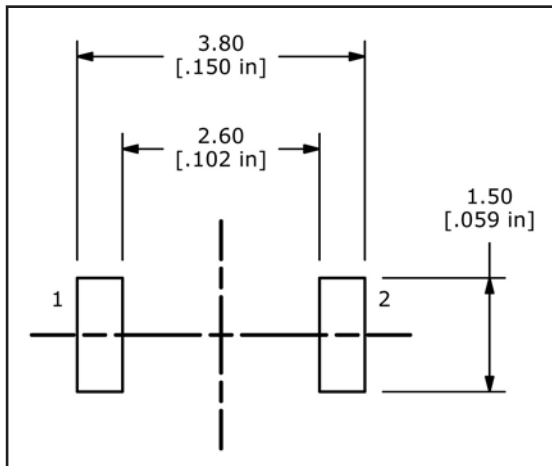
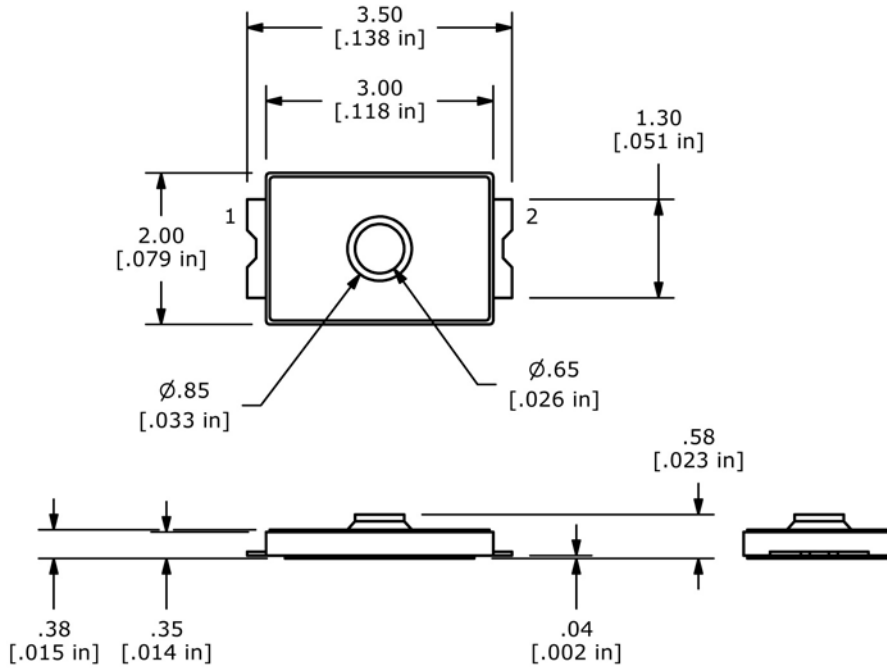

PCB LAYOUT

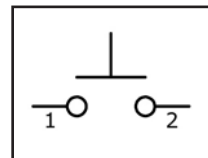

SCHEMATIC



- ANTI-VANDAL SWITCHES
- DETECTOR SWITCHES
- DIP SWITCHES
- KEYLOCK SWITCHES
- NAVIGATION SWITCHES
- PUSHBUTTON SWITCHES
- ROCKER SWITCHES
- ROTARY SWITCHES
- SLIDE SWITCHES
- SNAP ACTION SWITCHES
- TACTILE SWITCHES**
- TOGGLE SWITCHES
- CAP OPTIONS