

General purpose SCR suited for power supplies up to 400 Hz on resistive or inductive loads.

- $V_{DRM} = V_{RRM}$ up to 800 V.
- Glass passivated chip - High stability and reliability.
- High surge capability.

Thyristors à usage général pour des alimentations jusqu'à 400 Hz sur charges résistives ou inductives.

- $V_{DRM} = V_{RRM}$ jusqu'à 800 V.
- Pastille glassivée - Grande stabilité des caractéristiques.
- Courant de surcharge élevé.

$$I_{T(RMS)} = 1,6 \text{ A} / T_L = 50^\circ\text{C}$$

$$V_{DRM} = V_{RRM} = 100 \text{ V} \leq \dots \leq 800 \text{ V}$$

Case : TL (CB-274) plastic
Boîtier

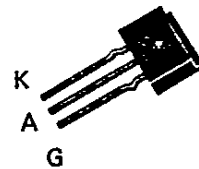

ABSOLUTE RATINGS (LIMITING VALUES) VALEURS LIMITEES ABSOLUES D'UTILISATION	Symbol	Value	Unit
RMS on-state current* <i>Courant efficace à l'état passant*</i>	$I_{T(RMS)}$	1,6 @ $T_L = 50^\circ\text{C}$	A
Mean on-state current* <i>Courant moyen à l'état passant*</i>	$I_T(AV)$	1 @ $T_L = 50^\circ\text{C}$	A
Non repetitive surge peak on-state current** <i>Courant non répétitif de surcharge crête accidentelle à l'état passant**</i>	I_{TSM} I_{TSM}	73 ($t = 8,3 \text{ ms}$) 70 ($t = 10 \text{ ms}$) @ $T_j \leq 110^\circ\text{C}$	A A
I^2t for fusing <i>Valeur de la constante I^2t</i>	I^2t	25 ($t = 10 \text{ ms}$) @ $T_j \leq 110^\circ\text{C}$	A ² s
Critical rate of rise of on-state current*** <i>Vitesse critique de croissance du courant à l'état passant***</i>	di/dt	100	A/ μs
Storage and operating junction temperatures <i>Températures extrêmes de stockage et de jonction en fonctionnement</i>	T_{stg} T_j	- 40, + 150 - 40, + 110	$^\circ\text{C}$ $^\circ\text{C}$

@ $T_j = 110^\circ\text{C}$	TL 1003	TL 2003	TL 4003	TL 6003	TL 8003
$V_{DRM} = V_{RRM}$ (V)	100	200	400	600	800

Thermal resistances <i>Résistances thermiques</i>	Symbol	Value	Unit
- Junction-leads <i>Jonction-connexions</i>	$R_{th(j-l)}$	35	$^\circ\text{C}/\text{W}$
- Junction-ambient on printed circuit (with Cu 1 cm ²) <i>Jonction-ambiante sur circuit imprimé (avec Cu 1 cm²)</i>	$R_{th(j-a)}$	50	$^\circ\text{C}/\text{W}$

*Single phase circuit, 180° conduction angle
*Circuit monophasé, angle de conduction 180°
*** $I_{GT} = 100 \text{ mA}$ $di_G/dt = 1 \text{ A}/\mu\text{s}$

**Half-sine wave
**Demi-onde sinusoïdale

May 1984 - 1/4

GATE CHARACTERISTICS (Maximum values)
CARACTERISTIQUES DE GACHETTE (Valeurs maximales)

PGM = 20 W (t = 10 μs)
 PG(AV) = 0,1 W

IFGM = 1 A (t = 10 μs)
 VFGM = 15 V (t = 10 μs)

VRGM = 5 V

ELECTRICAL CHARACTERISTICS
CARACTERISTIQUES ELECTRIQUES

Symbol	Value			Unit	Test conditions			
	min	typ	max					
I _{GT}			15	mA	T _j = 25°C	V _D = 12 V	R _L = 33 Ω	t _p ≥ 20 μs
V _{GT}		1,2	3	V	T _j = 25°C	V _D = 12 V	R _L = 33 Ω	t _p ≥ 20 μs
V _{GD}	0,2			V	T _j = 110°C	V _D = V _{DRM}	R _L = 3,3 kΩ	
I _H		20		mA	T _j = 25°C	I _T = 100 mA	Gate open	
V _{TM}			1,8	V	T _j = 25°C	I _{TM} = 3,2 A	t _p = 10 ms	
I _{DRM}			2	mA	T _j = 110°C	V _{DRM} specified		
I _{RRM'}			2	mA	T _j = 110°C	V _{RRM} specified		
t _{gt}		1,5		μs	T _j = 25°C I _G = 100 mA	I _T = 3,2 A di _G /dt = 1 A/μs	V _D = V _{DRM}	
t _q		80		μs	T _j = 110°C di _R /dt = 10 A/μs	I _T = 1 A dv/dt = 20 V/μs	V _R = 10 V V _D = 0,67 V _{DRM} Gate open	
dv/dt*		100		V/μs	T _j = 110°C	Linear slope up to 0,67 V _{DRM} specified Gate open		

*For higher guaranteed values, please consult us.

CASE DESCRIPTION
DESCRIPTION DU BOITIER

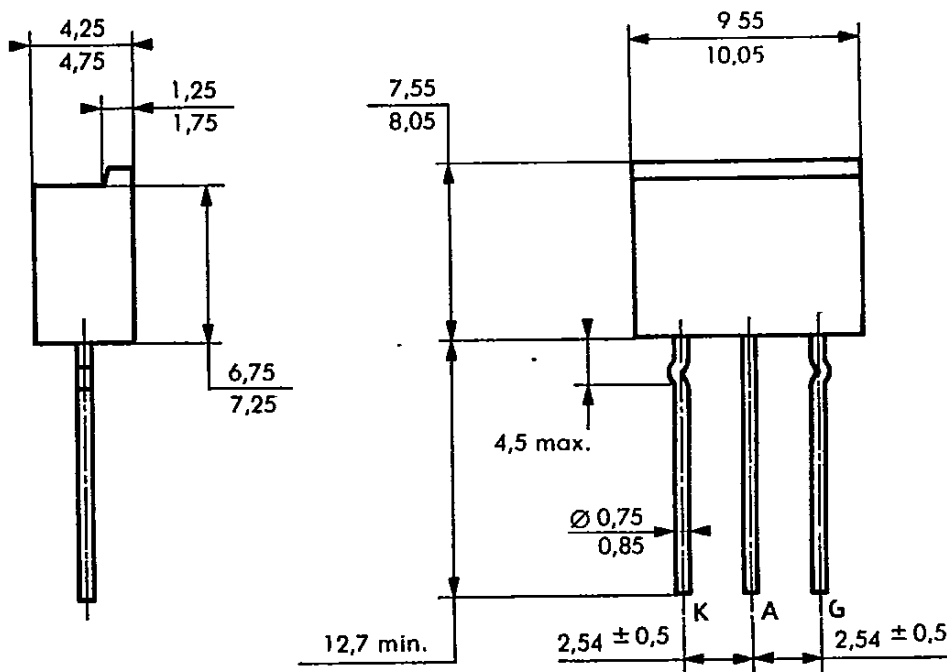

Cooling method : by convection (method A)
 Marking : type number
 Weight : 0,8 g

TL (CB-274) plastic

www.DataSheet4U.com

T.25-11

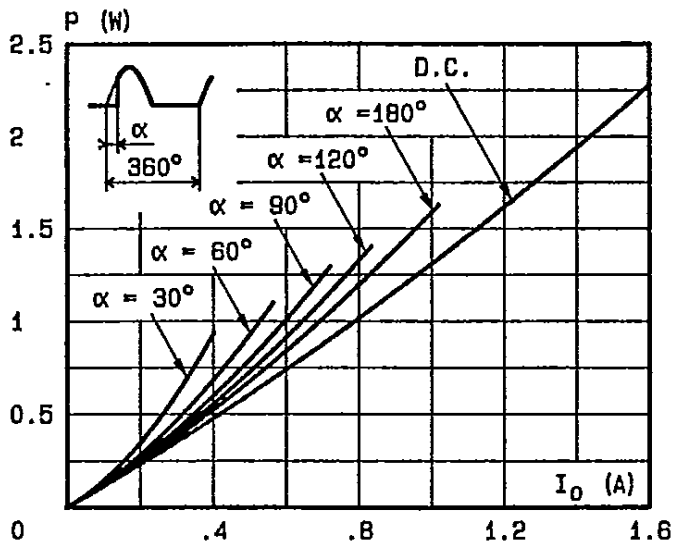

Fig.1 - Maximum mean power dissipation - versus mean on-state current.

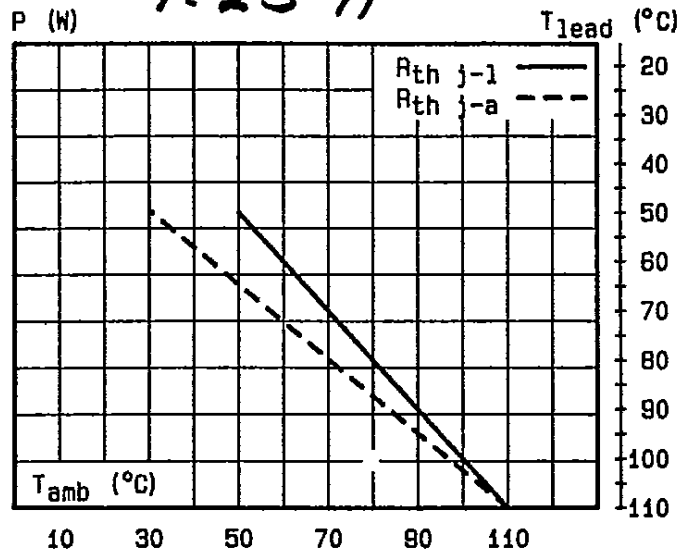

Fig.2 - Correlation between maximum mean power dissipation and maximum allowable temperatures (T_{amb} and T_{lead}).

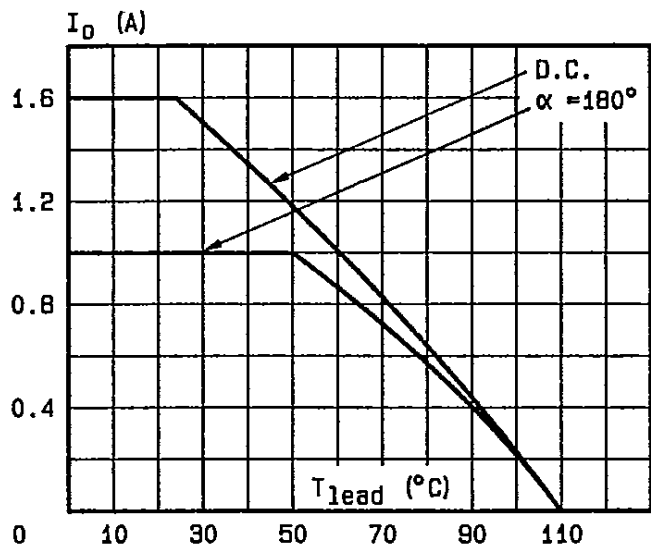

Fig.3 - Mean on-state current versus leads temperature.

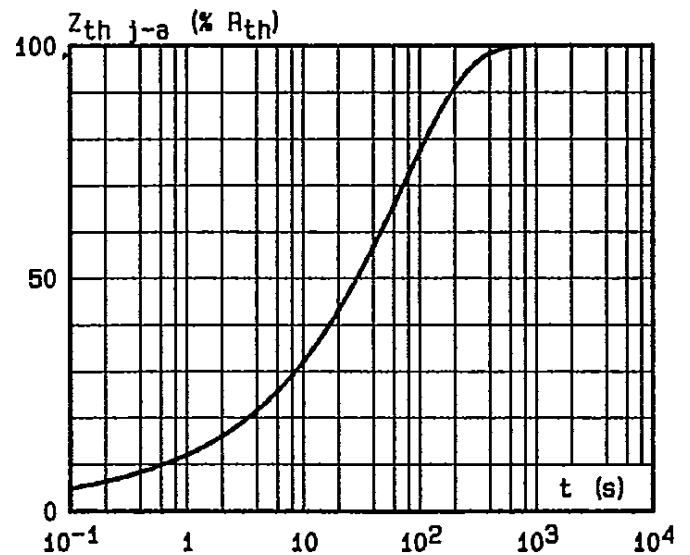

Fig.4 - Thermal transient impedance junction to ambient versus pulse duration.

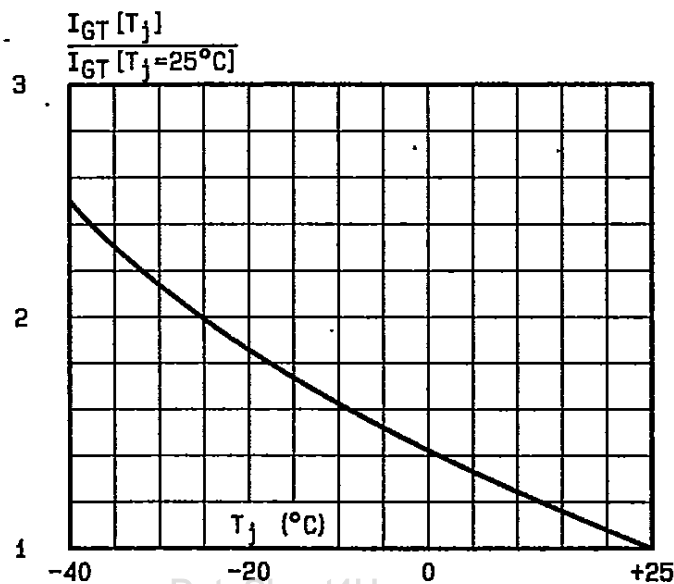

Fig.5 - Relative variation of gate trigger current versus junction temperature.

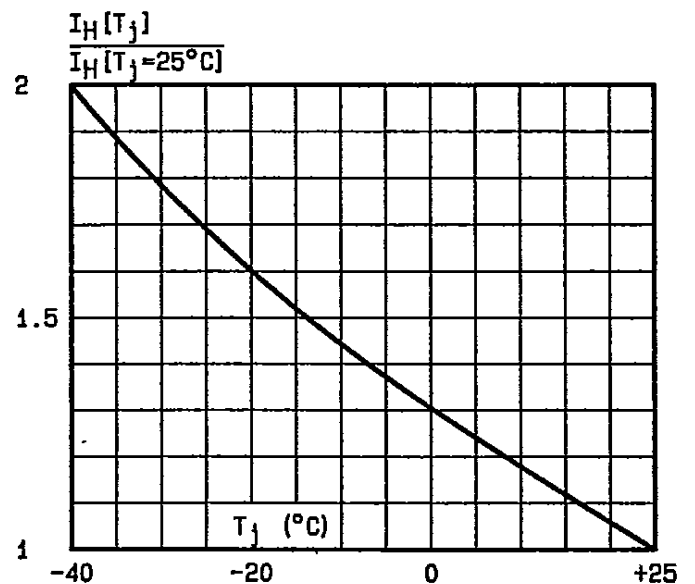

Fig.6 - Relative variation of holding current versus junction temperature.

T-25-11

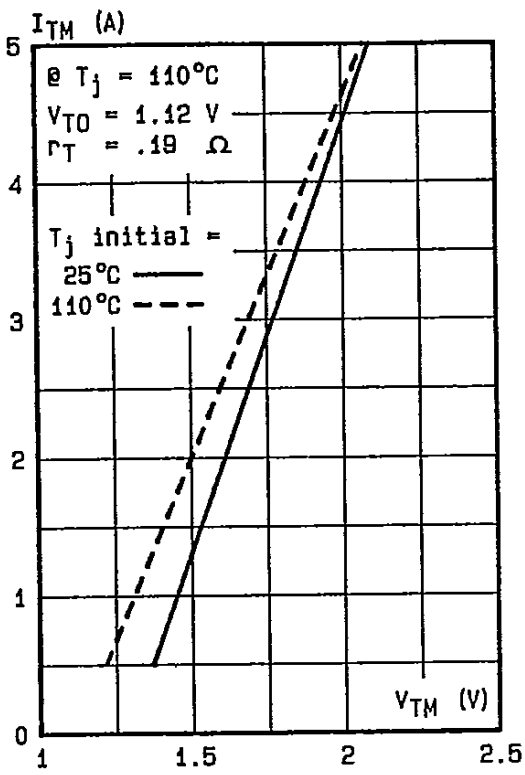

Fig.7 - On-state characteristics at low level (maximum values).

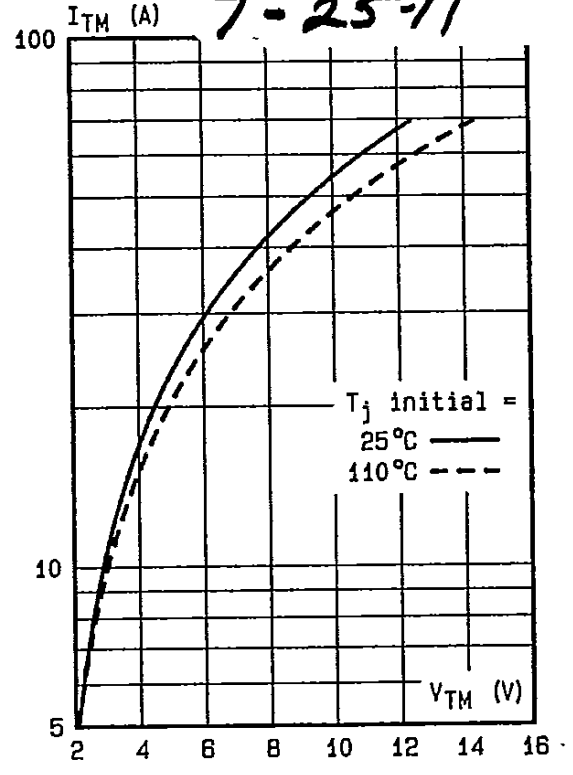

Fig.8 - On-state characteristics at high level (maximum values).

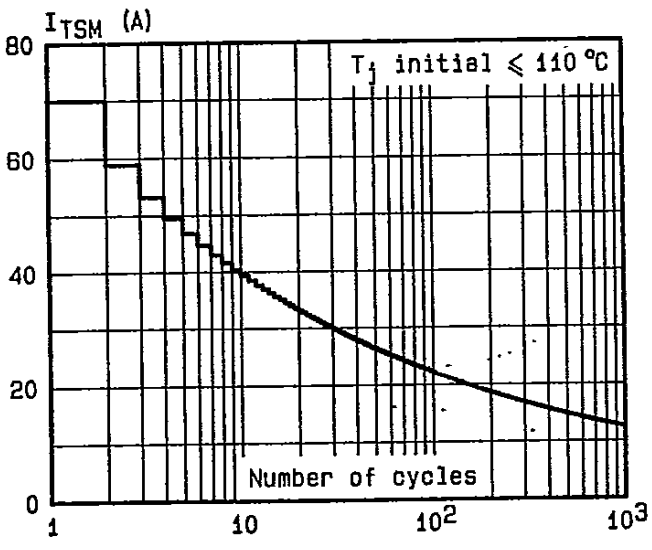

Fig.9 - Non repetitive surge peak on-state current versus number of cycles.

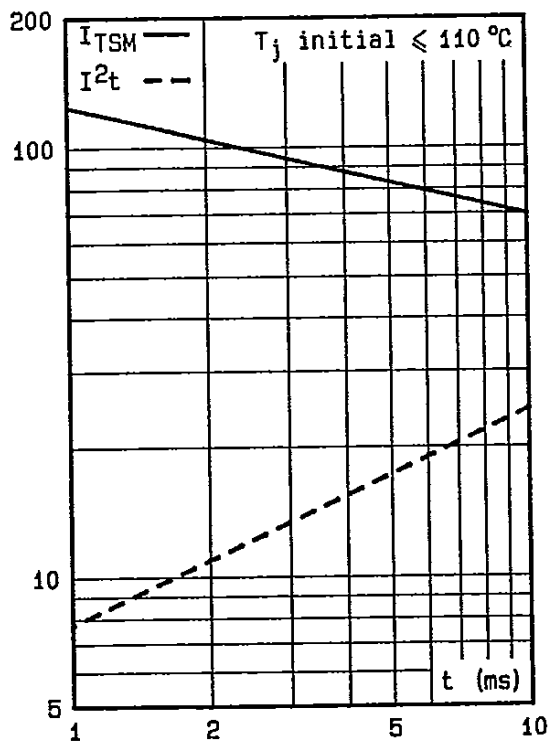

Fig.10 - Non repetitive surge peak on-state current for a sinusoidal pulse with width: $t \leq 10\text{ ms}$, and corresponding value of I^2t .