

# TLC2940 HIGH-PERFORMANCE CMOS VOLTAGE-CONTROLLED OSCILLATOR

SLAS244 – OCTOBER 1999

- **Stable Oscillation Using External Resistor**
- **Lock Frequency Range:**
  - 35 MHz to 75 MHz ( $V_{DD} = 5\text{ V} \pm 0.25\text{ V}$ ,  $T_A = -20^\circ\text{C}$  to  $85^\circ\text{C}$ )
  - 28 MHz to 50 MHz ( $V_{DD} = 3\text{ V} \pm 0.15\text{ V}$ ,  $T_A = -20^\circ\text{C}$  to  $85^\circ\text{C}$ )
- **Operating Free-Air Temperature Range,**  
 $T_A = -20^\circ\text{C}$  to  $85^\circ\text{C}$
- **8-Pin Thin Shrunked Small-Outline Package**

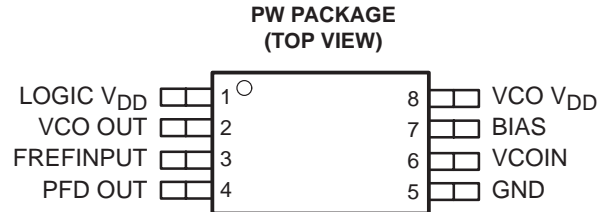

## description

The TLC2940 is a high-performance analog voltage-controlled oscillator (VCO) using Texas Instruments 0.8- $\mu\text{m}$  CMOS process. The VCO oscillating operation can be performed by an external bias resistor connected to the internal oscillation circuitry, and the oscillation frequency range is set by this bias resistor. The lock frequency range for PLL applications is from 35 MHz to 75 MHz (over operating free-air temperature range,  $V_{DD} = 5\text{ V} \pm 5\%$ ), and from 28 MHz to 50 MHz (over operating free-air temperature range,  $V_{DD} = 3\text{ V} \pm 5\%$ ). The stable analog PLL can be configured within these frequency ranges.

The device is available in an 8-pin TSSOP surface-mount package.

The PLL block is configured using a counter, a required LPF, and a phase frequency detector (PFD).

### AVAILABLE OPTIONS

$T_A$	PACKAGE
	TSSOP (PW)
$-20^\circ\text{C}$ to $85^\circ\text{C}$	TLC2940IPW

## functional block diagram

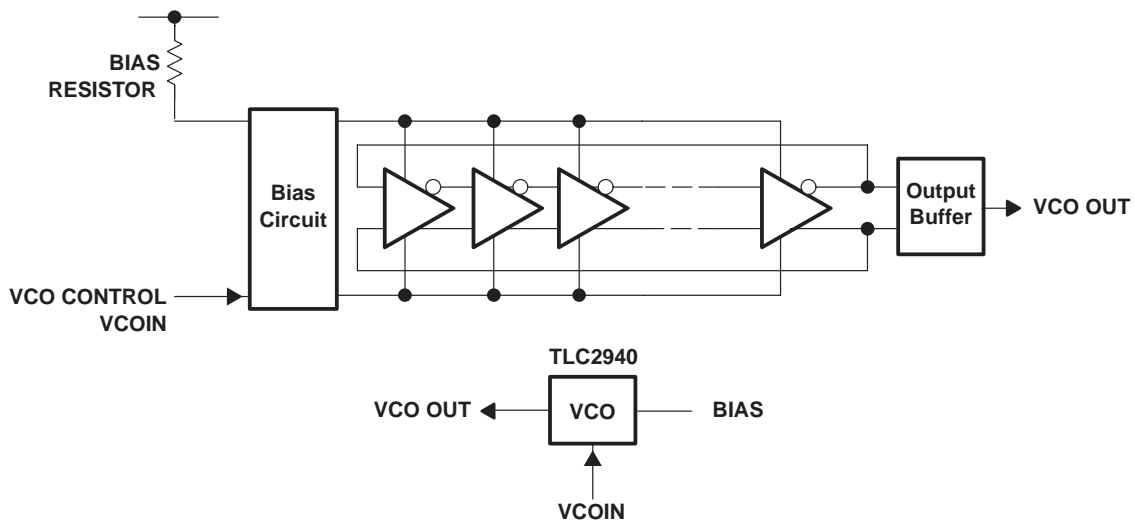

Please be aware that an important notice concerning availability, standard warranty, and use in critical applications of Texas Instruments semiconductor products and disclaimers thereto appears at the end of this data sheet.

PRODUCTION DATA information is current as of publication date. Products conform to specifications per the terms of Texas Instruments standard warranty. Production processing does not necessarily include testing of all parameters.

**TEXAS  
INSTRUMENTS**

POST OFFICE BOX 655303 • DALLAS, TEXAS 75265

Copyright © 1999, Texas Instruments Incorporated

# TLC2940

## HIGH-PERFORMANCE CMOS VOLTAGE-CONTROLLED OSCILLATOR

SLAS244 – OCTOBER 1999

### Terminal Functions

TERMINAL NAME	NO.	I/O†	DESCRIPTION
BIAS	7	M	Bias supply terminal for internal VCO. The resistor should be located between $V_{DD}$ and this terminal.
FREFINPUT	3	I	Not used. This terminal should be tied to ground.
GND	5	PS	Ground
LOGIC $V_{DD}$	1	PS	Power supply for the internal logic circuitry (PFD portion, input/output portion). It is recommended that this terminal is separated from the VCO supply voltage terminal.
PFD OUT	4	O	Not used. This terminal should be unconnected (open).
VCOIN	6	I	VCO control voltage input.
VCO OUT	2	O	VCO output. This terminal is tied to a low level at inhibit status.
VCO $V_{DD}$	8	PS	Supply voltage for VCO analog portion.

† I: Input, O: Output, PS: Power supply/GND, M: Others

### detailed description

The TLC2940 is an analog VCO IC that generates a frequency that is a multiple of a reference frequency for a PLL block configuration. Normally, a PLL block is composed of a VCO, a phase frequency detector, counter logic, and a loop filter.

The following is a description for the analog VCO of the TLC2940.

The built-in analog VCO is composed of a ring oscillator portion for oscillation operation and a bias control portion to generate a bias level to supply to the ring oscillator. The oscillation operation is performed by a bias resistor ( $R_{BIAS}$ ) connected between the bias control (pin 7) and the supply voltage (pin 8). The VCO oscillation frequency is determined by this resistor value,  $R_{BIAS}$ , that is, the oscillation frequency decreases as the resistor value increases, and the oscillation frequency increases as the resistor value decreases. The lock frequency range is from 35 MHz to 75 MHz with a  $R_{BIAS}$  of 1.5 k $\Omega$  to 4.3 k $\Omega$  at 5-V operation and from 28 MHz to 50 MHz with a  $R_{BIAS}$  of 1.5 k $\Omega$  to 2.7 k $\Omega$  at 3-V operation over the recommended supply voltage and operating free-air temperature range.

Refer to the curves shown in the typical characteristics section for the lock frequency ranges with varying  $R_{BIAS}$  values.

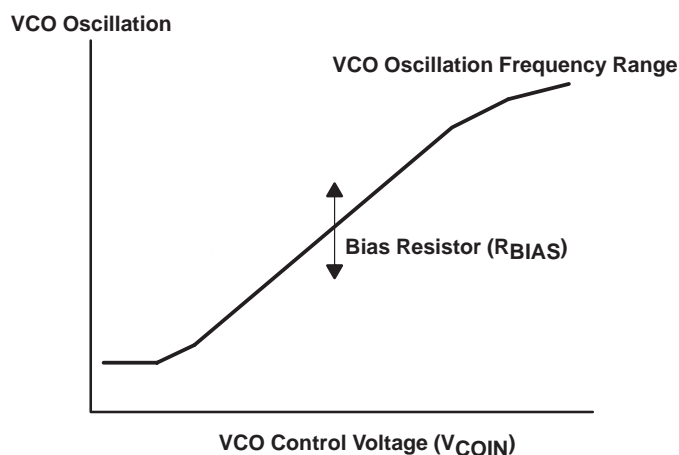

Figure 1. VCO Oscillation Frequency Range Setting

# TLC2940

## HIGH-PERFORMANCE CMOS VOLTAGE-CONTROLLED OSCILLATOR

SLAS244 – OCTOBER 1999

### absolute maximum ratings over operating free-air temperature (unless otherwise noted)†

Supply voltage (any supply), $V_{DD}$ (see Note 1)	7 V
Input voltage range (any input), $V_I$ (see Note 1)	-0.5 V to $V_{DD} + 0.5$ V
Input current (any input), $I_I$	$\pm 20$ mA
Output current (any output), $I_O$	$\pm 20$ mA
Continuous total power dissipation ( $T_A = 25^\circ\text{C}$ or below), $P_D$ (see Note 2)	700 mW
Operating free-air temperature range, $T_A$	-20°C to 85°C
Storage temperature range, $T_{stg}$	-65°C to 150°C
Lead temperature 1,6 mm (1/16 inch) from case for 10 seconds	260°C

† Stresses beyond those listed under “absolute maximum ratings” may cause permanent damage to the device. These are stress ratings only, and functional operation of the device at these or any other conditions beyond those indicated under “recommended operating conditions” is not implied. Exposure to absolute-maximum-rated conditions for extended periods may affect device reliability.

- NOTES: 1. All voltage values are with respect to network GND terminals.  
 2. For operation above 25°C free-air temperature, derate linearly at the rate of 5.6 mW/°C.

### recommended operating conditions

PARAMETER		MIN	NOM	MAX	UNIT	
Supply voltage, $V_{DD}$ (any supply, see Notes 3 and 4)	3-V operation	2.85	3	3.15	V	
	5-V operation	4.75	5	5.25		
Input voltage, $V_I$ (inputs except VCO IN)		0		$V_{DD}$	V	
Output current, $I_O$ (any output)		0		$\pm 2$	mA	
VCO control voltage at VCO IN		1		$V_{DD}-0.5$	V	
Lock frequency	3-V operation	$R_{BIAS} = 1.5$ k $\Omega$		42	50	MHz
		$R_{BIAS} = 1.8$ k $\Omega$		37	47	
		$R_{BIAS} = 2.2$ k $\Omega$		33	45	
		$R_{BIAS} = 2.7$ k $\Omega$		28	42	
	5-V operation	$R_{BIAS} = 1.5$ k $\Omega$		65	75	
		$R_{BIAS} = 2.4$ k $\Omega$		50	65	
		$R_{BIAS} = 3.3$ k $\Omega$		43	56	
		$R_{BIAS} = 4.3$ k $\Omega$		35	50	
VCO oscillation frequency setting resistor, $R_{BIAS}$	3-V operation	1.5		2.7	k $\Omega$	
	5-V operation	1.5		4.3		
Operating free-air temperature, $T_A$		-20		85	°C	

- NOTES: 3. It is recommended that the logic supply terminal (LOGIC  $V_{DD}$ ) and the VCO supply terminal (VCO  $V_{DD}$ ) should be at the same voltage and separate from each other.  
 4. The bypass capacitor should be located as close as possible to each power supply.  
 5. The FREFINPUT (pin 3) and PFD OUT (pin 4) terminals are input/output terminals preset for logic function respectively. In normal operation, the FREFINPUT should be tied to GND and PDF OUT should be left unconnected (open).



# TLC2940

## HIGH-PERFORMANCE CMOS VOLTAGE-CONTROLLED OSCILLATOR

SLAS244 – OCTOBER 1999

### electrical characteristics over recommended operating free-air temperature range, $V_{DD} = 3\text{ V}$ (unless otherwise noted)

PARAMETER		TEST CONDITIONS	MIN	TYP	MAX	UNIT
$V_{OH}$	High-level output voltage, VCO OUT	$I_{OH} = -2\text{ mA}$	2.4			V
$V_{OL}$	Low-level output voltage, VCO OUT	$I_{OL} = 2\text{ mA}$			0.3	V
$Z_i(\text{VCOIN})$	Input impedance at VCOIN	$\text{VCO IN} = 1/2 V_{DD}$		10		$M\Omega$
$I_{DD}(\text{VCO})$	Supply current	See Note 6		6	10	mA
$f_{osc}$	Oscillation frequency	$R_{BIAS} = 2.4\text{ k}\Omega$ , $\text{VCOIN} = 1/2 V_{DD}$	32	40	48	MHz
$t_r$	Output rise time	$\text{VCOIN} = 0\text{ V}$ , $R_{BIAS} = 2.4\text{ k}\Omega$ , $C_L = 15\text{ pF}$		13		ns
$t_f$	Output fall time	$\text{VCOIN} = 0\text{ V}$ , $R_{BIAS} = 2.4\text{ k}\Omega$ , $C_L = 15\text{ pF}$		6		ns
	Output duty ratio	$R_{BIAS} = 2.4\text{ k}\Omega$ , $\text{VCOIN} = 1/2 V_{DD}$ , See Note 7	40%	44%	60%	
$\alpha(f_{osc})$	Temperature coefficient of oscillation frequency	$\text{VCOIN} = 1/2 V_{DD}$ , $R_{BIAS} = 2.4\text{ k}\Omega$ , $T_A = -20^\circ\text{C}$ to $85^\circ\text{C}$		0.07		$\%/^\circ\text{C}$
$k_{SVS}(f_{osc})$	Supply voltage coefficient of oscillation frequency	$\text{VCOIN} = 1.5\text{ V}$ , $R_{BIAS} = 2.4\text{ k}\Omega$ , $V_{DD} = 2.7\text{ V}$ to $3.3\text{ V}$		0.01		$\%/mV$

NOTES: 6.  $\text{VCOIN} = 1/2 V_{DD}$ ,  $R_{BIAS} = 2.4\text{ k}\Omega$ , current through pin 1 and 8.  
7. The maximum and minimum value of this parameter are not production tested.

### electrical characteristics over recommended operating free-air temperature range, $V_{DD} = 5\text{ V}$ (unless otherwise noted)

PARAMETER		TEST CONDITIONS	MIN	TYP	MAX	UNIT
$V_{OH}$	High-level output voltage, VCO OUT	$I_{OH} = -2\text{ mA}$	4.5			V
$V_{OL}$	Low-level output voltage, VCO OUT	$I_{OL} = 2\text{ mA}$			0.5	V
$Z_i(\text{VCOIN})$	Input impedance at VCOIN	$\text{VCOIN} = 1/2 V_{DD}$		10		$M\Omega$
$I_{DD}(\text{VCO})$	Supply current	See Note 6		16	30	mA
$f_{osc}$	Oscillation frequency	$R_{BIAS} = 2.4\text{ k}\Omega$ , $\text{VCOIN} = 1/2 V_{DD}$	45	65	85	MHz
$t_r$	Output rise time	$\text{VCOIN} = 0\text{ V}$ , $R_{BIAS} = 2.4\text{ k}\Omega$ , $C_L = 15\text{ pF}$		5.8		ns
$t_f$	Output fall time	$\text{VCOIN} = 0\text{ V}$ , $R_{BIAS} = 2.4\text{ k}\Omega$ , $C_L = 15\text{ pF}$		3.2		ns
	Output duty ratio	$R_{BIAS} = 2.4\text{ k}\Omega$ , $\text{VCOIN} = 1/2 V_{DD}$ , See Note 7	40%	46%	60%	
$\alpha(f_{osc})$	Temperature coefficient of oscillation frequency	$\text{VCOIN} = 1/2 V_{DD}$ , $R_{BIAS} = 2.4\text{ k}\Omega$ , $T_A = -20^\circ\text{C}$ to $85^\circ\text{C}$		0.06		$\%/^\circ\text{C}$
$k_{SVS}(f_{osc})$	Supply voltage coefficient of oscillation frequency	$\text{VCOIN} = 2.5\text{ V}$ , $R_{BIAS} = 2.4\text{ k}\Omega$ , $V_{DD} = 4.5\text{ V}$ to $5.5\text{ V}$		0.005		$\%/mV$

NOTES: 6.  $\text{VCOIN} = 1/2 V_{DD}$ ,  $R_{BIAS} = 2.4\text{ k}\Omega$ , current through pin 1 and 8.  
7. The maximum and minimum value of this parameter are not production tested.



PARAMETER MEASUREMENT INFORMATION

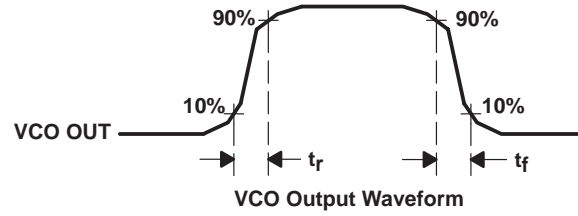
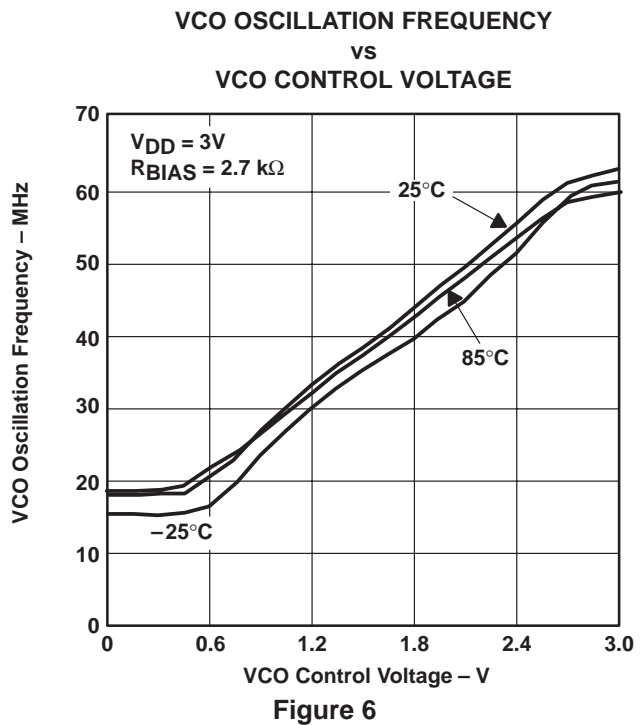
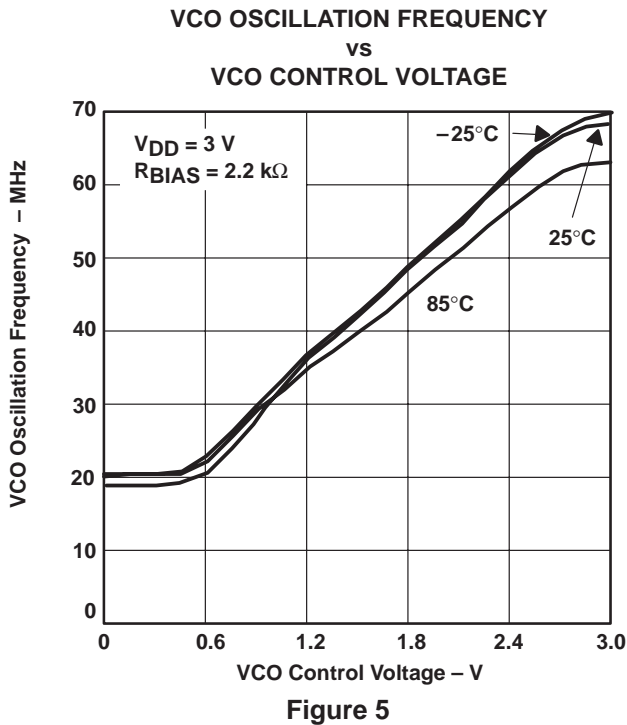
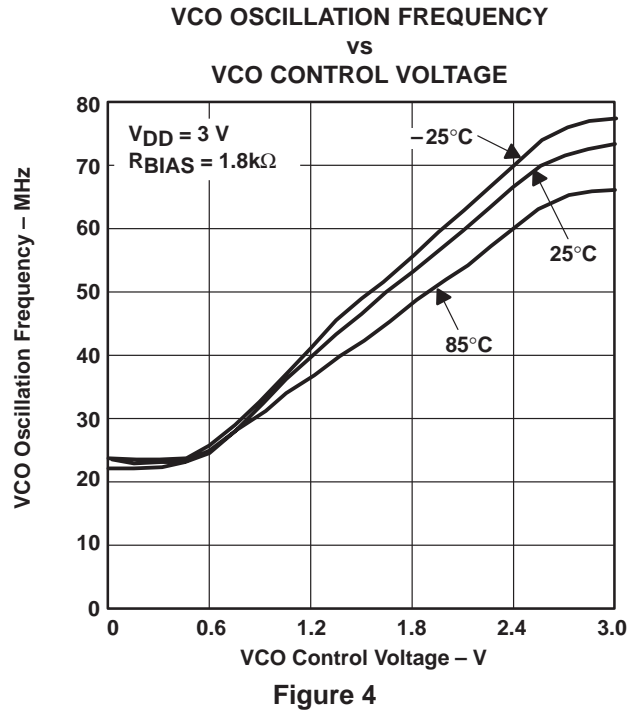
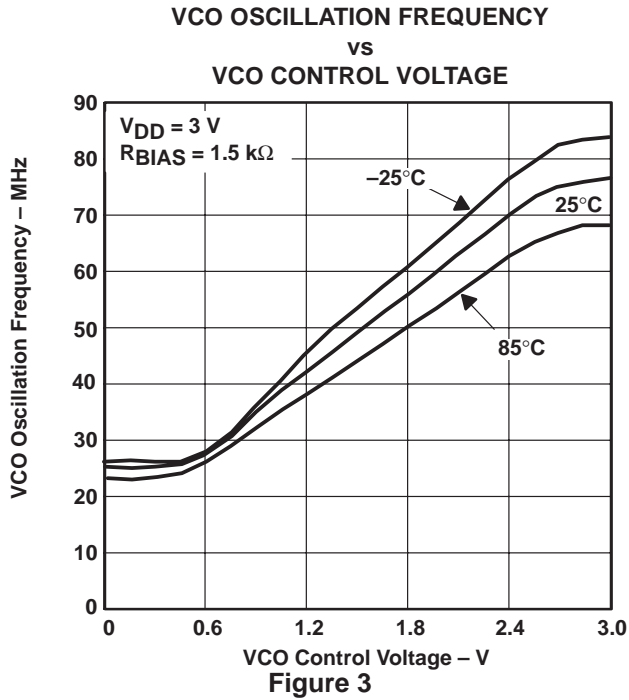

Figure 2. VCO Output Waveform

# TLC2940 HIGH-PERFORMANCE CMOS VOLTAGE-CONTROLLED OSCILLATOR

SLAS244 – OCTOBER 1999

## TYPICAL CHARACTERISTICS



TYPICAL CHARACTERISTICS

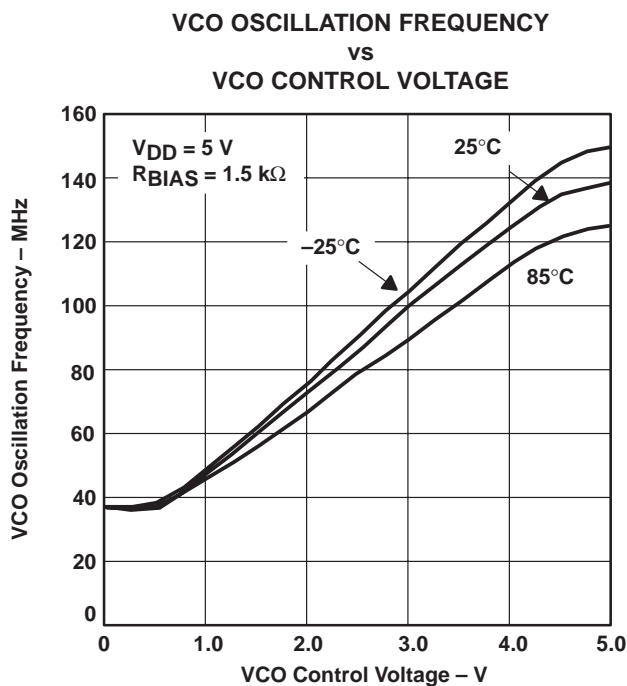

Figure 7

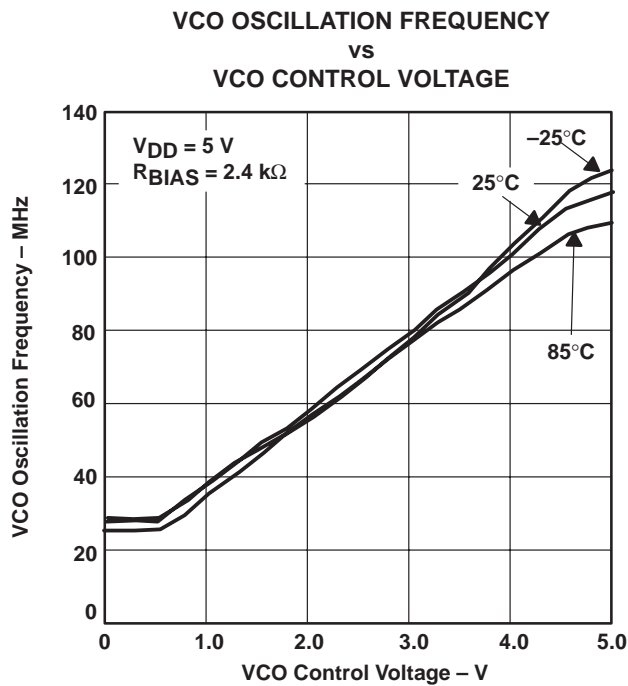

Figure 8

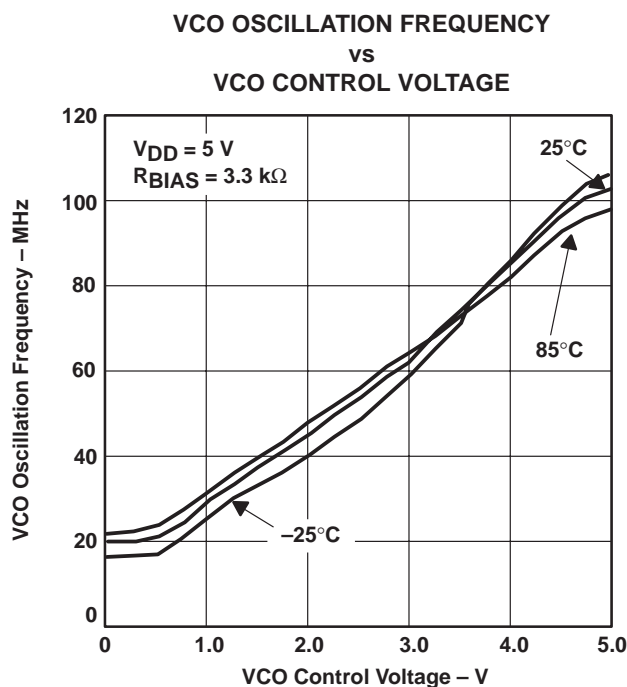

Figure 9

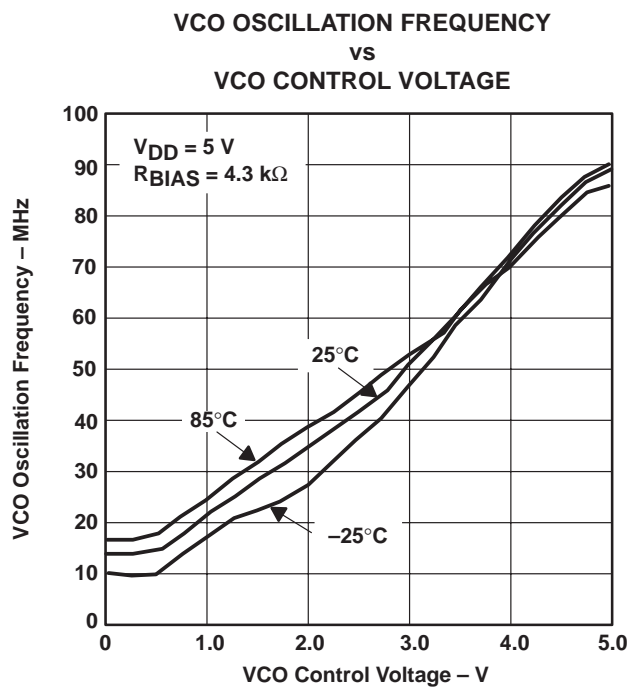

Figure 10

# TLC2940 HIGH-PERFORMANCE CMOS VOLTAGE-CONTROLLED OSCILLATOR

SLAS244 – OCTOBER 1999

## MECHANICAL DATA

PW (R-PDSO-G\*\*)

PLASTIC SMALL-OUTLINE PACKAGE

14 PIN SHOWN

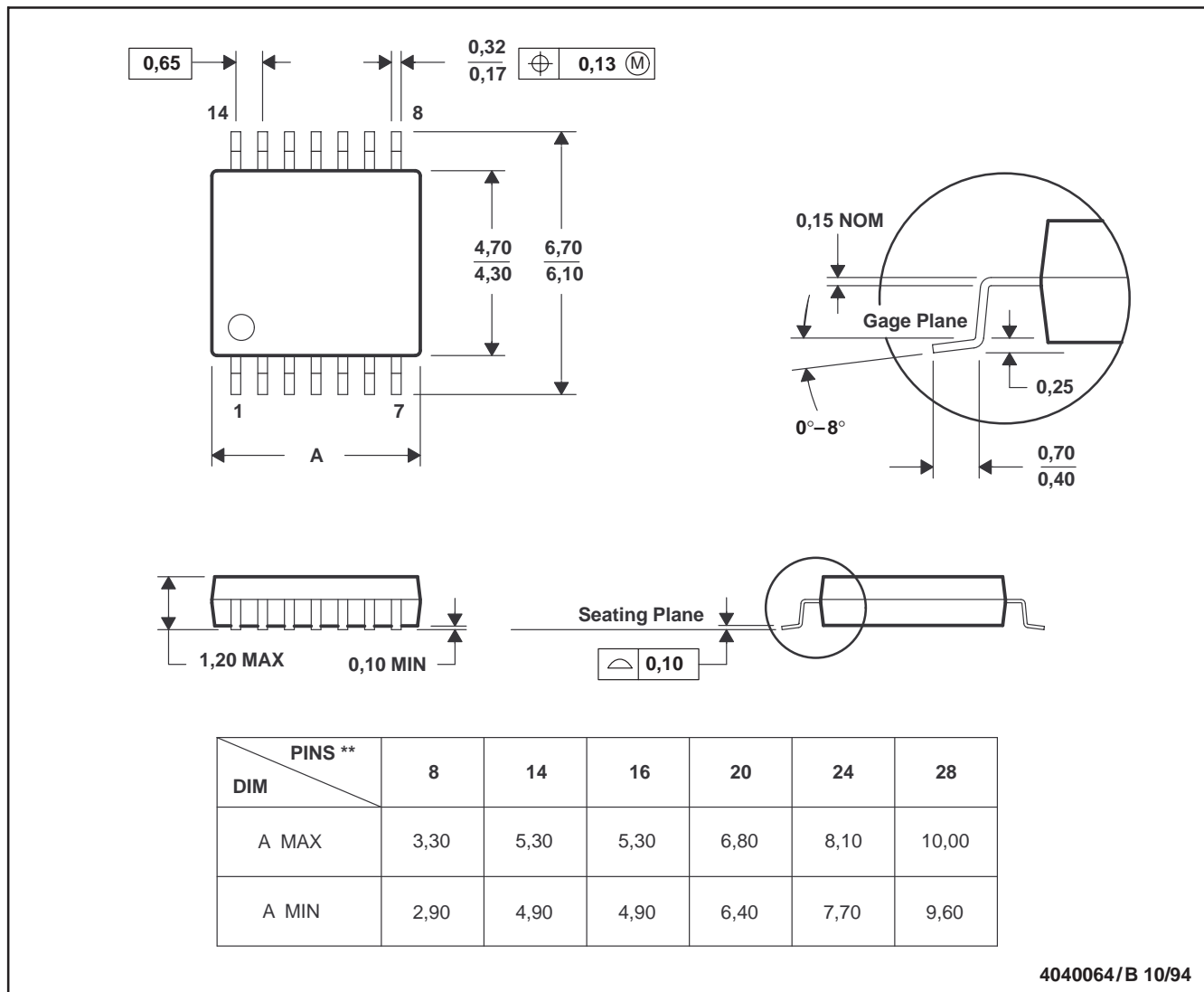

- NOTES: A. All linear dimensions are in millimeters.  
 B. This drawing is subject to change without notice.  
 C. Body dimensions do not include mold flash or protrusion not to exceed 0,15.



## IMPORTANT NOTICE

Texas Instruments and its subsidiaries (TI) reserve the right to make changes to their products or to discontinue any product or service without notice, and advise customers to obtain the latest version of relevant information to verify, before placing orders, that information being relied on is current and complete. All products are sold subject to the terms and conditions of sale supplied at the time of order acknowledgement, including those pertaining to warranty, patent infringement, and limitation of liability.

TI warrants performance of its semiconductor products to the specifications applicable at the time of sale in accordance with TI's standard warranty. Testing and other quality control techniques are utilized to the extent TI deems necessary to support this warranty. Specific testing of all parameters of each device is not necessarily performed, except those mandated by government requirements.

CERTAIN APPLICATIONS USING SEMICONDUCTOR PRODUCTS MAY INVOLVE POTENTIAL RISKS OF DEATH, PERSONAL INJURY, OR SEVERE PROPERTY OR ENVIRONMENTAL DAMAGE ("CRITICAL APPLICATIONS"). TI SEMICONDUCTOR PRODUCTS ARE NOT DESIGNED, AUTHORIZED, OR WARRANTED TO BE SUITABLE FOR USE IN LIFE-SUPPORT DEVICES OR SYSTEMS OR OTHER CRITICAL APPLICATIONS. INCLUSION OF TI PRODUCTS IN SUCH APPLICATIONS IS UNDERSTOOD TO BE FULLY AT THE CUSTOMER'S RISK.

In order to minimize risks associated with the customer's applications, adequate design and operating safeguards must be provided by the customer to minimize inherent or procedural hazards.

TI assumes no liability for applications assistance or customer product design. TI does not warrant or represent that any license, either express or implied, is granted under any patent right, copyright, mask work right, or other intellectual property right of TI covering or relating to any combination, machine, or process in which such semiconductor products or services might be or are used. TI's publication of information regarding any third party's products or services does not constitute TI's approval, warranty or endorsement thereof.