

OPTIREG™ linear TLE4271-2

5-V low drop fixed voltage regulator



Features

- Output voltage tolerance $\leq \pm 2\%$
- Low-drop voltage
- Integrated overtemperature protection
- Reverse polarity protection
- Input voltage up to 42 V
- Overvoltage protection up to 65 V (≤ 400 ms)
- Short-circuit proof
- Suitable for use in automotive electronics
- Wide temperature range
- Adjustable reset and watchdog time
- Green Product (RoHS compliant)

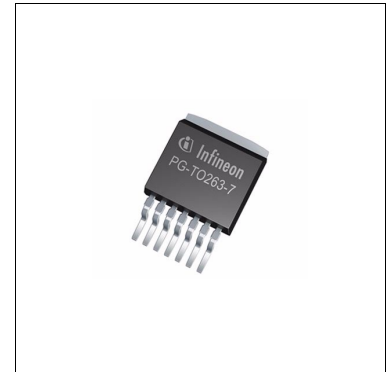

Potential applications

General automotive applications.

Product validation

Qualified for automotive applications. Product validation according to AEC-Q100/101.

Description

The OPTIREG™ linear TLE4271-2 is functional and electrical identical to TLE4271.

The device is a 5-V low drop fixed voltage regulator. The maximum input voltage is 42 V (65 V, ≤ 400 ms). Up to an input voltage of 26 V and for an output current up to 550 mA it regulates the output voltage within a 2% accuracy. The short circuit protection limits the output current of more than 650 mA. The IC can be switched off via the inhibit input. An integrated watchdog monitors the connected controller. The device incorporates overvoltage protection and temperature protection that disables the circuit at overtemperature.

Type	Package	Marking
TLE4271-2G	PG-TO263-7	4271-2

Table of contents

	Features	1
	Potential applications	1
	Product validation	1
	Description	1
	Table of contents	2
1	Block diagram	3
2	Pin configuration	4
3	General product characteristics	5
3.1	Absolute maximum ratings	5
3.2	Operating range	6
3.3	Characteristics	7
4	Circuit description	9
5	Typical performance characteristics	13
6	Package information	18
7	Revision history	19

Block diagram

1 Block diagram

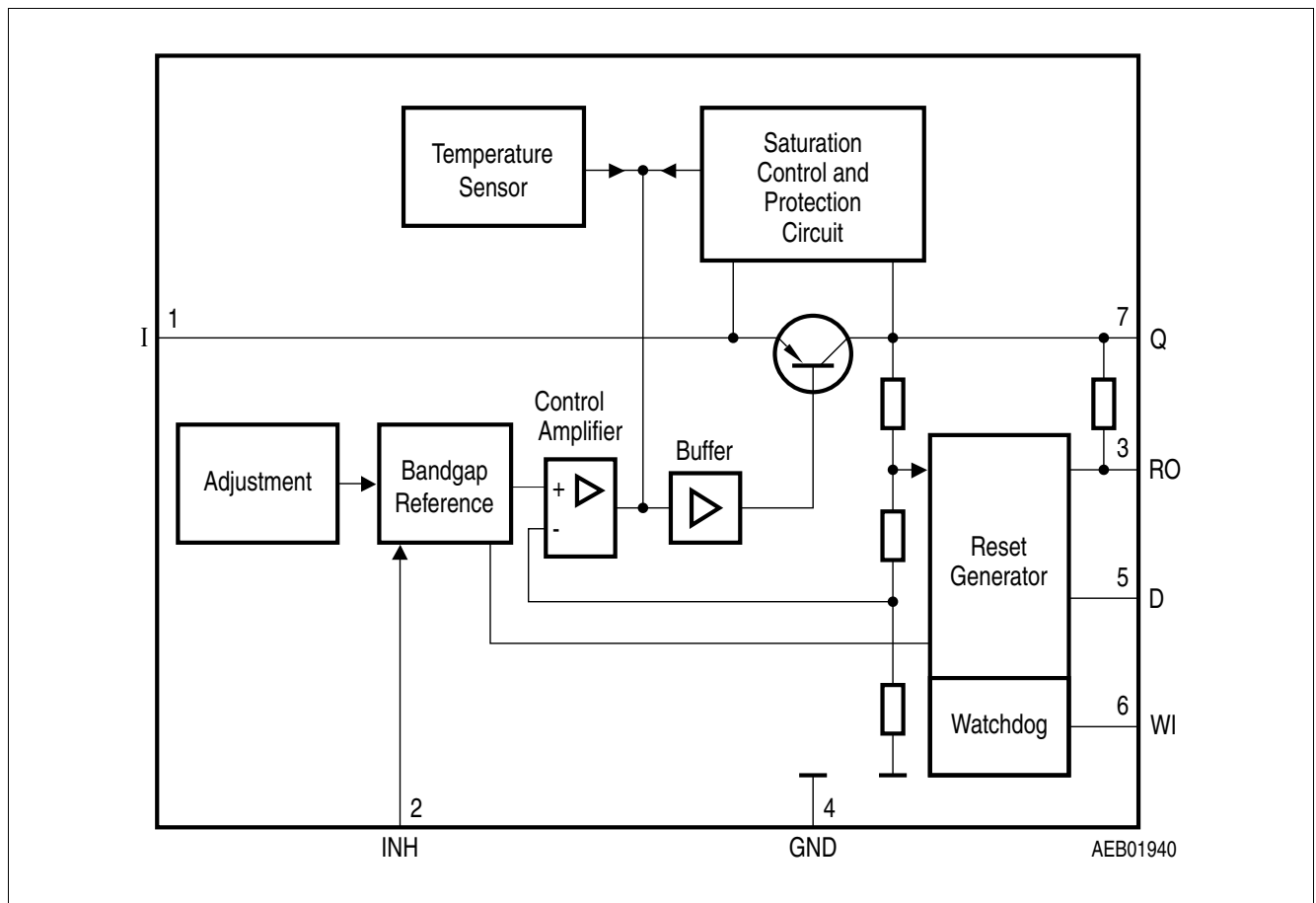

Figure 1 Block diagram

Pin configuration

2 Pin configuration

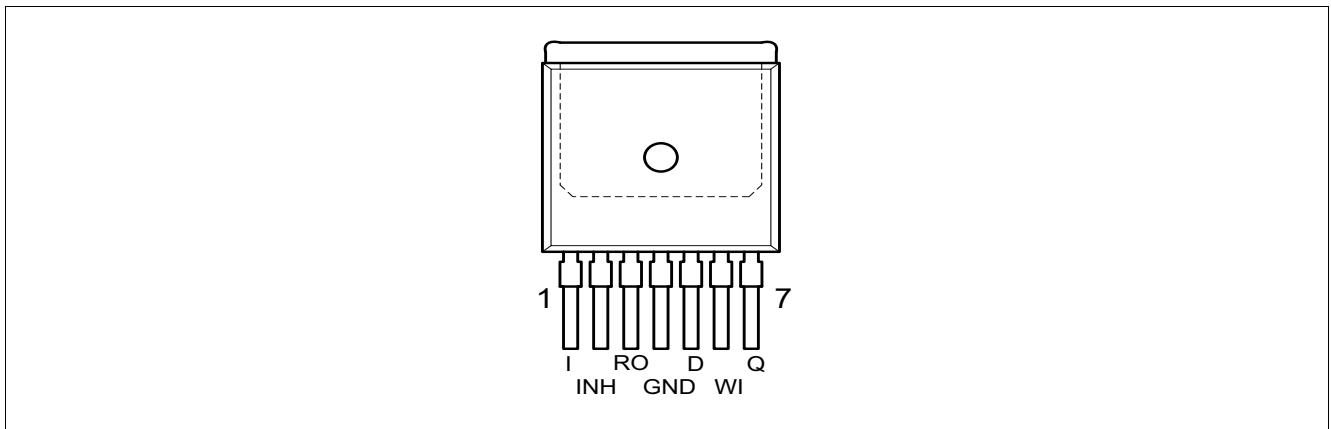

Figure 2 Pin configuration (top view)

Table 1 Pin definitions and functions

Pin	Symbol	Function
1	I	Input Block to ground directly on the IC with ceramic capacitor.
2	INH	Inhibit
3	RO	Reset output The open collector output is connected to the 5 V output via an integrated resistor of 30 kΩ.
4	GND	Ground
5	D	Reset delay Connect a capacitor to ground for delay time adjustment.
6	WI	Watchdog input
7	Q	5-V output Block to ground with 22 μF capacitor, ESR < 3 Ω.

General product characteristics

3 General product characteristics

3.1 Absolute maximum ratings

Table 2 Absolute maximum ratings

$T_j = -40^\circ\text{C}$ to 150°C

Parameter	Symbol	Values			Unit	Note or Test Condition
		Min.	Typ.	Max.		
Input						
Voltage	V_I	-42	-	42	V	-
Voltage	V_I	-	-	65	V	$t \leq 400$ ms
Current	I_I	-	-	-	mA	Internally limited
Inhibit						
Voltage	V_{INH}	-42	-	42	V	-
Voltage	V_{INH}	-	-	65	V	$t \leq 400$ ms
Current	I_{INH}	-	-	-	mA	Internally limited
Reset output						
Voltage	V_{RO}	-0.3	-	42	V	-
Current	I_{RO}	-	-	-	mA	Internally limited
Reset delay						
Voltage	V_D	-0.3	-	7	V	-
Current	I_D	-5	-	5	mA	-
Watchdog						
Voltage	V_W	-0.3	-	7	V	-
Current	I_W	-5	-	5	mA	-
Output						
Voltage	V_Q	-1.0	-	16	V	-
Current	I_Q	-5	-	-	mA	Internally limited
Ground						
Current	I_{GND}	-0.5	-	-	A	-
Temperatures						
Junction temperature	T_j	-	-	150	$^\circ\text{C}$	-
Storage temperature	T_{stg}	-50	-	150	$^\circ\text{C}$	-

General product characteristics

3.2 Operating range

Table 3 Operating range

Parameter	Symbol	Values			Unit	Note or Test Condition
		Min.	Typ.	Max.		
Input voltage	V_I	6	–	40	V	–
Junction temperature	T_j	-40	–	150	°C	–
Thermal resistance						
Junction ambient	R_{thja}	–	–	70	K/W	
Junction case	R_{thjc}	–	–	3	K/W	–
	Z_{thjc}	–	–	2	K/W	$t < 1$ ms

General product characteristics

3.3 Characteristics

Table 4 Characteristics

$V_I = 13.5\text{ V}$; $T_j = -40^\circ\text{C}$ to 125°C ; $V_{\text{INH}} > V_{\text{U,INH}}$ (unless otherwise specified)

Parameter	Symbol	Values			Unit	Note or Test Condition
		Min.	Typ.	Max.		
Output voltage	V_Q	4.90	5.00	5.10	V	$I_Q = 5\text{ mA}$ to 550 mA ; $V_I = 6\text{ V}$ to 26 V
Output voltage	V_Q	4.90	5.00	5.10	V	$V_I = 26\text{ V}$ to 36 V ; $I_Q \leq 300\text{ mA}$
Output current limiting	$I_{Q\text{max}}$	650	800	–	mA	$V_Q = 0\text{ V}$
Current consumption $I_q = I_1$	I_q	–	–	6	μA	$V_{\text{INH}} = 0\text{ V}$; $I_Q = 0\text{ mA}$
Current consumption $I_q = I_1$	I_q	–	800	–	μA	$V_{\text{INH}} = 5\text{ V}$; $I_Q = 0\text{ mA}$
Current consumption $I_q = I_1 - I_Q$	I_q	–	1	1.5	mA	$I_Q = 5\text{ mA}$
Current consumption $I_q = I_1 - I_Q$	I_q	–	55	75	mA	$I_Q = 550\text{ mA}$
Current consumption $I_q = I_1 - I_Q$	I_q	–	70	90	mA	$I_Q = 550\text{ mA}$; $V_I = 5\text{ V}$
Drop voltage	V_{dr}	–	350	700	mV	$I_Q = 550\text{ mA}^{1)}$
Load regulation	ΔV_Q	–	25	50	mV	$I_Q = 5\text{ mA}$ to 550 mA ; $V_I = 6\text{ V}$
Supply voltage regulation	ΔV_Q	–	12	25	mV	$V_I = 6\text{ V}$ to 26 V ; $I_Q = 5\text{ mA}$
Power supply ripple rejection	$PSRR$	–	54	–	dB	$f_r = 100\text{ Hz}$; $V_r = 0.5\text{ Vpp}$

Reset generator

Switching threshold	V_{RT}	4.5	4.65	4.8	V	–
Reset high voltage	V_{ROH}	4.5	–	–	V	–
Saturation voltage	$V_{\text{RO,SAT}}$	–	60	–	mV	$R_{\text{intern}} = 30\text{ k}\Omega$; $V_Q = 1.0\text{ V}$ to 4.5 V
Saturation voltage	$V_{\text{RO,SAT}}$	–	200	400	mV	$I_R = 3\text{ mA}^{2)}$; $V_Q = 4.4\text{ V}$
Reset pull-up	R	18	30	46	k Ω	Internally connected to Q
Lower reset timing threshold	V_{LD}	0.2	0.45	0.8	V	$V_Q < V_{\text{RT}}$
Charge current	I_D	8	14	25	μA	$V_D = 1.0\text{ V}$
Upper timing threshold	V_{UD}	1.4	1.8	2.3	V	–
Delay time	t_D	8	13	18	ms	$C_D = 100\text{ nF}$
Reset reaction time	t_{RR}	–	–	3	μs	$C_D = 100\text{ nF}$

General product characteristics

Table 4 Characteristics (cont'd)

$V_I = 13.5\text{ V}$; $T_j = -40^\circ\text{C}$ to 125°C ; $V_{INH} > V_{U,INH}$ (unless otherwise specified)

Parameter	Symbol	Values			Unit	Note or Test Condition
		Min.	Typ.	Max.		
Overvoltage protection						
Turn-off voltage	$V_{I,ov}$	40	44	46	V	–
Inhibit						
Turn-on voltage	$V_{U,INH}$	1.0	2.0	3.5	V	$V_Q = \text{high} (> 4.5\text{ V})$
Turn-off voltage	$V_{L,INH}$	0.8	1.3	3.3	V	$V_Q = \text{low} (< 0.8\text{ V})$
Inhibit current	I_{INH}	8	12	25	μA	$V_{INH} = 5\text{ V}$
Watchdog						
Upper watchdog switching threshold	V_{UDW}	1.4	1.8	2.3	V	–
Lower watchdog switching threshold	V_{LDW}	0.2	0.45	0.8	V	–
Discharge current	I_{DWD}	1.5	2.7	3.5	μA	$V_D = 1\text{ V}$
Charge current	I_{DWC}	8	14	25	μA	$V_D = 1\text{ V}$
Watchdog period	$t_{WD,P}$	40	55	80	ms	$C_D = 100\text{ nF}$
Watchdog trigger time	$t_{WI,tr}$	30	45	66	ms	$C_D = 100\text{ nF}$ see diagram
Watchdog pulse slew rate	V_{WI}	5	–	–	V/ μs	From 20% to 80% V_Q

1) Drop voltage = $V_I - V_Q$ (measured when the output voltage has dropped 100 mV from the nominal value obtained at 13.5 V input).

2) Test condition not applicable during delay time for power-on reset.

Circuit description

4 Circuit description

The control amplifier compares a reference voltage, which is kept highly accurate by resistance adjustment, to a voltage that is proportional to the output voltage and drives the base of a series transistor via a buffer. Saturation control as a function of the load current prevents any over-saturation of the power element.

The reset output RO is in high-state if the voltage on the delay capacitor C_D is greater or equal V_{UD} . The delay capacitor C_D is charged with the current I_D for output voltages greater than the reset threshold V_{RT} . If the output voltage gets lower than V_{RT} ('reset condition') a fast discharge of the delay capacitor C_D sets in and as soon as V_D gets lower than V_{LD} the reset output RO is set to low-level.

The time for the delay capacitor charge from V_{UD} to V_{LD} is the reset delay time t_D .

When the voltage on the delay capacitor has reached V_{UD} and reset was set to high, the watchdog circuit is enabled and discharges C_D with the constant current I_{DWD} . If there is no rising edge observed at the watchdog input, C_D will be discharge down to V_{LDW} , then reset output RO will be set to low and C_D will be charged again with the current I_{DWC} until V_D reaches V_{UD} and reset will be set high again.

If the watchdog pulse (rising edge at watchdog input WI) occurs during the discharge period C_D is charged again and the reset output stays high. After V_D has reached V_{UD} , the periodical behavior starts again.

Internal protection circuits protect the IC against:

- Overload
- Overvoltage
- Overtemperature
- Reverse polarity

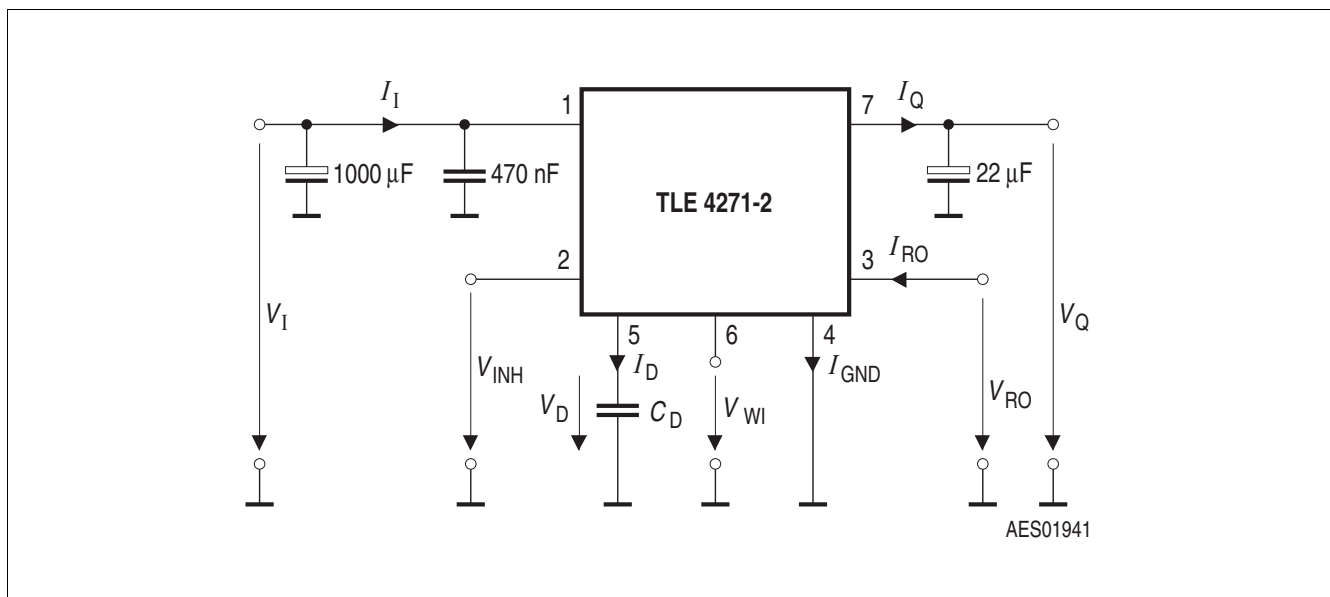

Figure 3 Test circuit

Circuit description

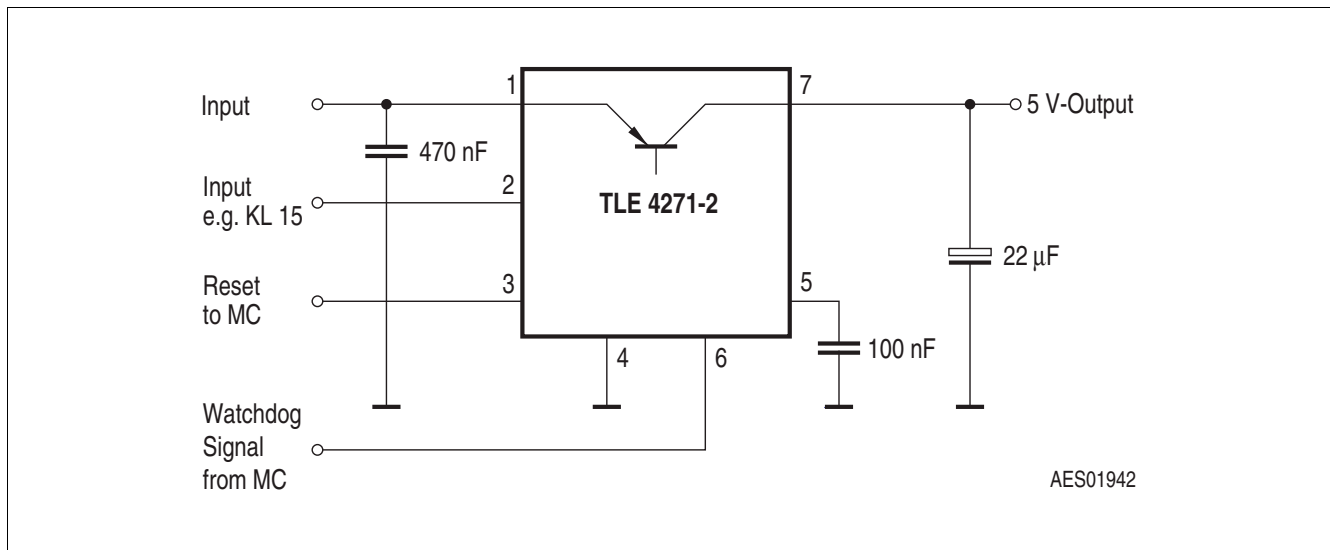

Figure 4 Circuit

Application description

The IC regulates an input voltage in the range of $6\text{ V} < V_I < 40\text{ V}$ to $V_{Qnom} = 5.0\text{ V}$. Up to 26 V it produces a regulated output current of more than 550 mA. Above 26 V the save-operating-area protection allows operation up to 36 V with a regulated output current of more than 300 mA. Overvoltage protection limits operation at 42 V. The overvoltage protection hysteresis restores operation if the input voltage has dropped below 36 V. The IC can be switched off via the inhibit input, which causes the quiescent current to drop below 10 µA. A reset signal is generated for an output voltage of $V_Q < 4.5\text{ V}$. The watchdog circuit monitors a connected controller. If there is no positive-going edge at the watchdog input within a fixed time, the reset output is set to low. The delay for power-on reset and the maximum permitted watchdog-pulse period can be set externally with a capacitor.

Design notes for external components

An input capacitor C_I is necessary for compensation of line influences. The resonant circuit consisting of lead inductance and input capacitance can be damped by a resistor of approx. 1 Ω in series with C_I . An output capacitor C_Q is necessary for the stability of the regulating circuit. Stability is guaranteed at values of $C_Q \geq 22\text{ µF}$ and an ESR of $< 3\text{ Ω}$.

Reset circuitry

If the output voltage decreases below 4.5 V, an external capacitor C_D on pin D will be discharged by the reset generator. If the voltage on this capacitor drops below V_{DRL} , a reset signal is generated on pin RO, i.e. reset output is set low. If the output voltage rises above the reset threshold, C_D will be charged with constant current. After the power-on-reset time the voltage on the capacitor reaches V_{DU} and the reset output will be set high again. The value of the power-on-reset time can be set within a wide range depending of the capacitance of C_D .

Reset timing

The power-on reset delay time is defined by the charging time of an external capacitor C_d which can be calculated as follows:

$$t_D = C_D \times \Delta V / I_D \tag{4.1}$$

Definitions:

- C_D = delay capacitor

Circuit description

- t_D = reset delay time
- I_D = charge current, typical 14 μ A
- $\Delta V = V_{UD}$, typical 1.8 V
- V_{UD} = upper delay timing threshold at C_D for reset delay time

The reset reaction time t_{rr} is the time it takes the voltage regulator to set the reset out LOW after the output voltage has dropped below the reset threshold. It is typically 1 μ s for delay capacitor of 47 nF. For other values for C_d the reaction time can be estimated using the following equation:

$$t_{RR} \approx 20 \text{ s/F} \times C_d \tag{4.2}$$

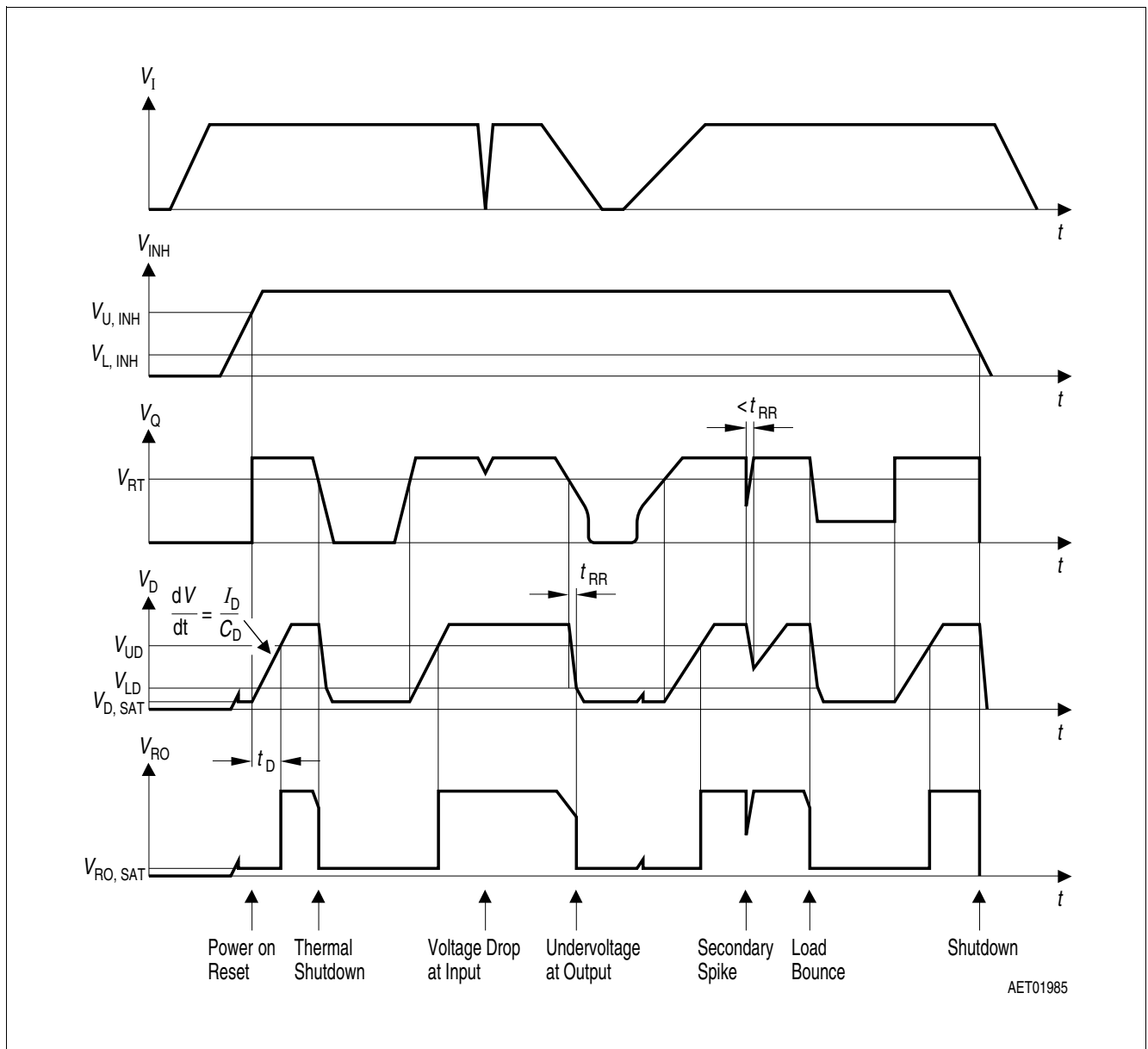

Figure 5 Time response

Circuit description

Watchdog timing

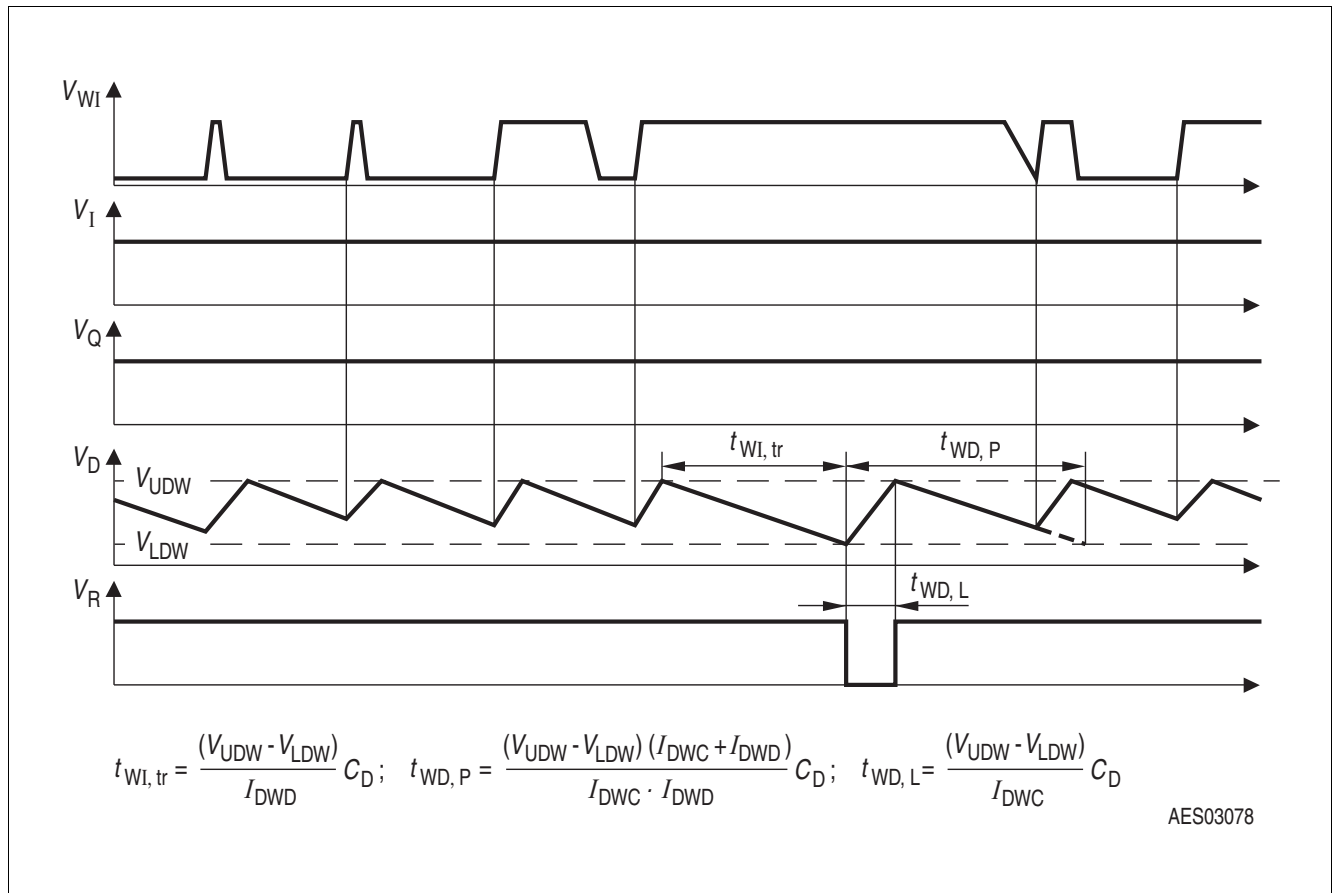
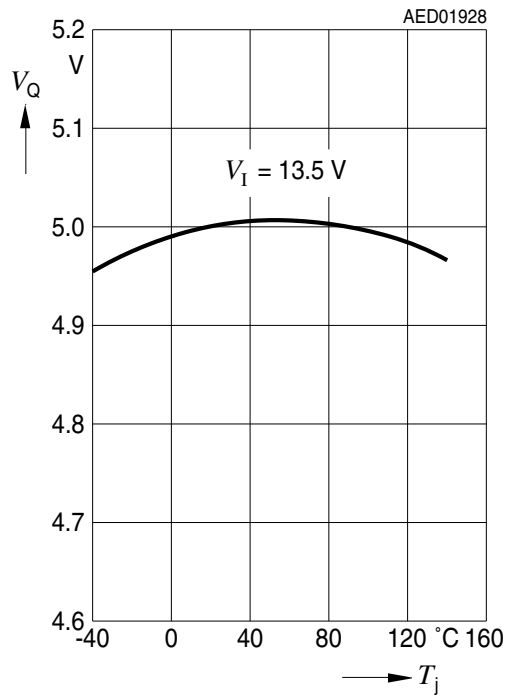

Figure 6 Time response, watchdog behavior

Typical performance characteristics

5 Typical performance characteristics

Output voltage V_Q versus junction temperature T_j



Output voltage V_Q versus input voltage V_I ($V_{INH} = V_I$)

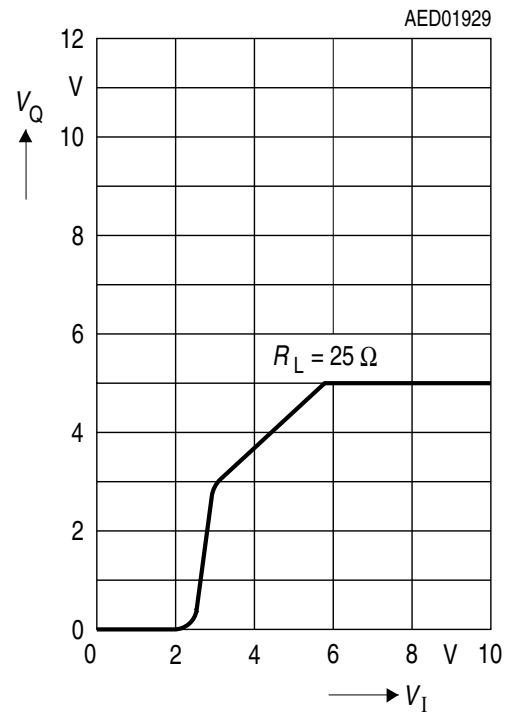

Typical performance characteristics

Output current limit $I_{Q\max}$ versus junction temperature T_j

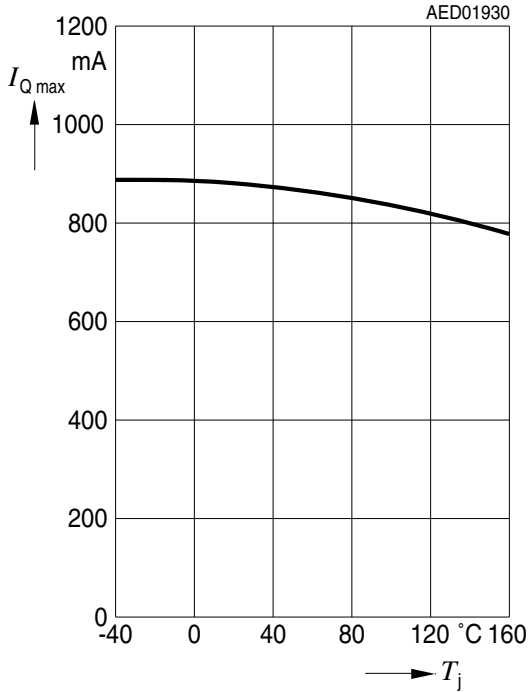

Output current I_Q versus input voltage V_I

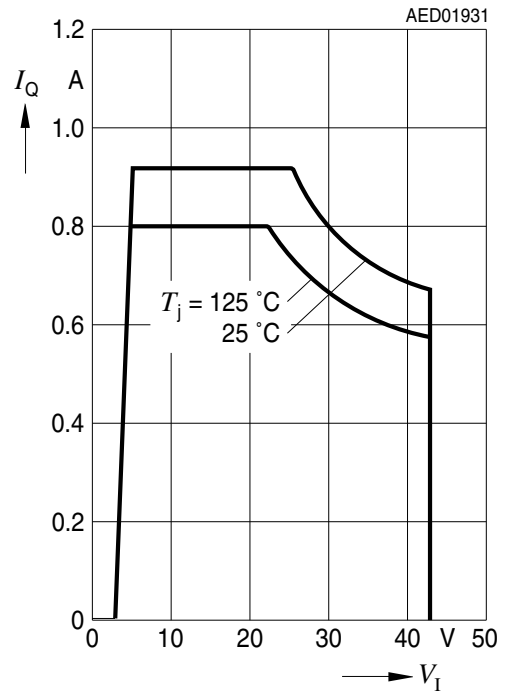

Current consumption I_q versus output current I_Q

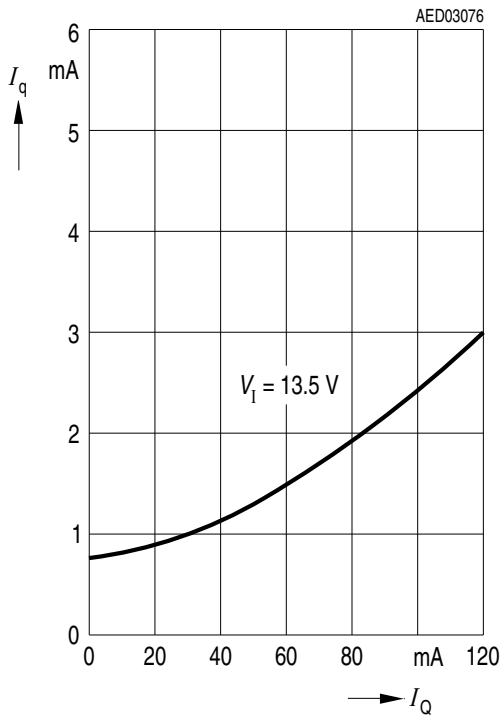

Current consumption I_q versus output current I_Q

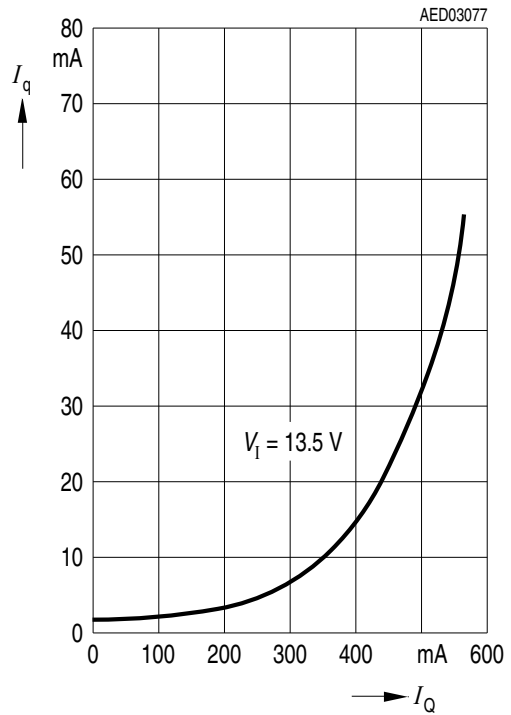

Typical performance characteristics

Current consumption I_q versus input voltage V_I

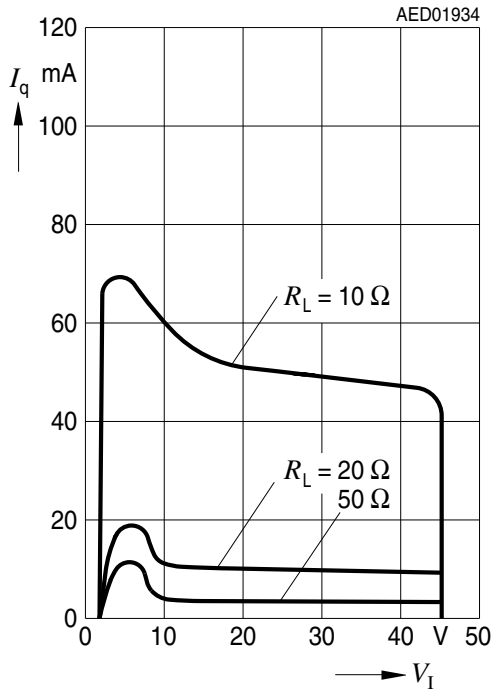

Drop voltage V_{Dr} versus output current I_Q

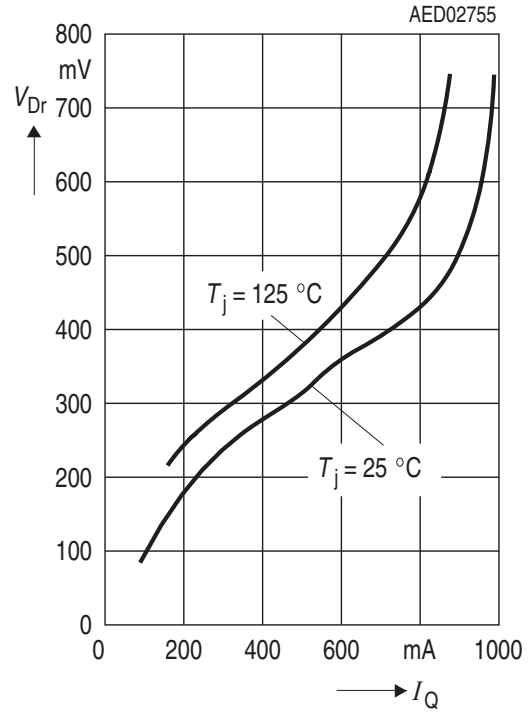

Inhibit current I_{INH} versus inhibit voltage V_{INH}

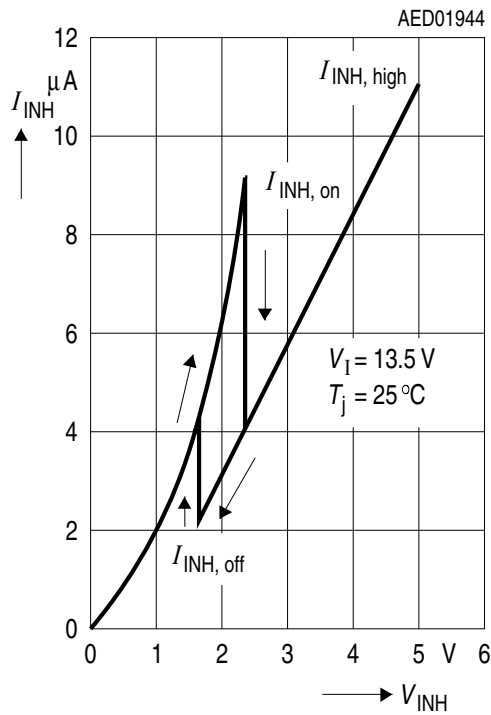

Output voltage V_Q versus inhibit voltage V_{INH}

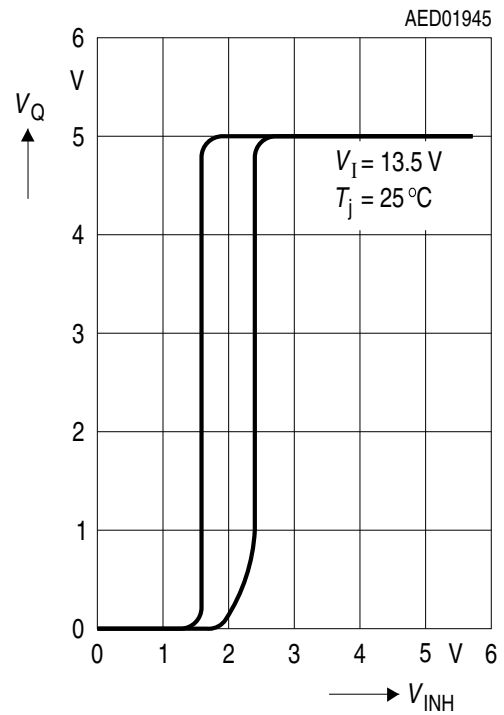

Typical performance characteristics

Inhibit current consumptions I_{INH} versus temperature T_j

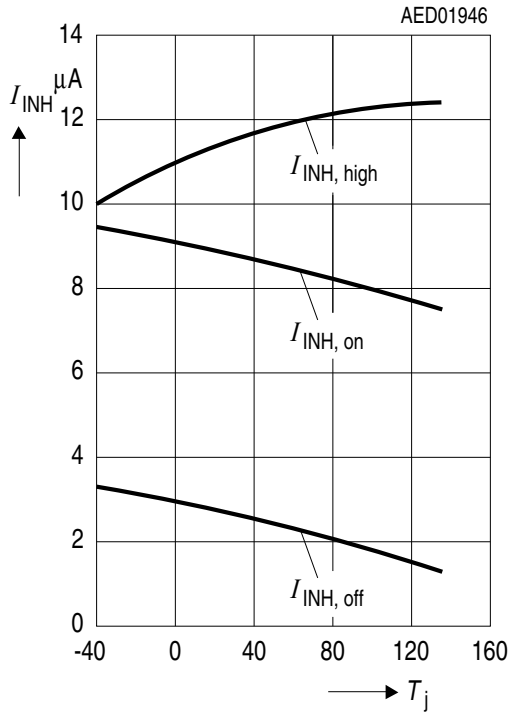

Inhibit voltages V_{INH} versus junction temperature T_j

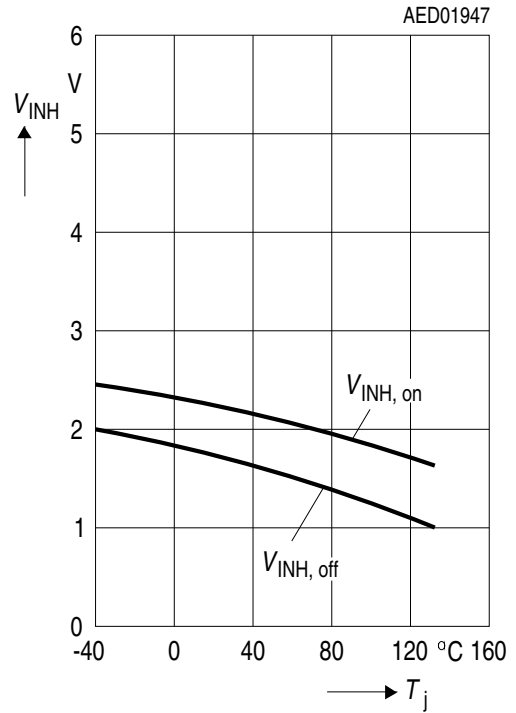

Switching voltage V_{UD} and V_{LDW} versus junction temperature T_j

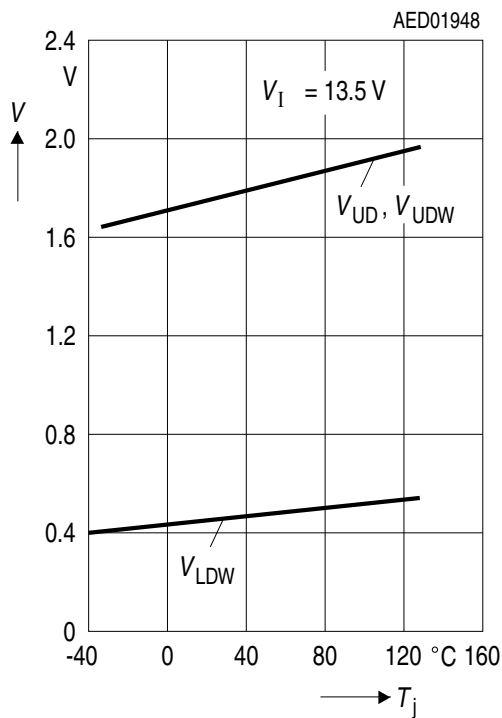

Typical performance characteristics

Charge current I_D , I_{DWC} and discharge current I_{DWD} versus junction temperature T_j

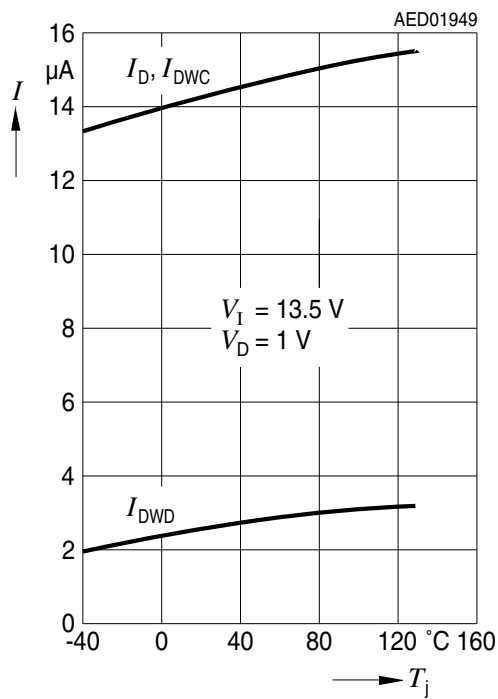

Watchdog pulse time T_w versus junction temperature T_j

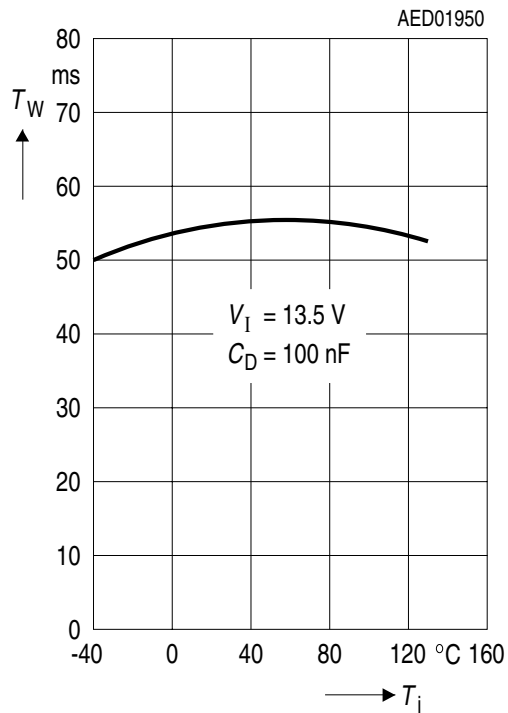

6 Package information

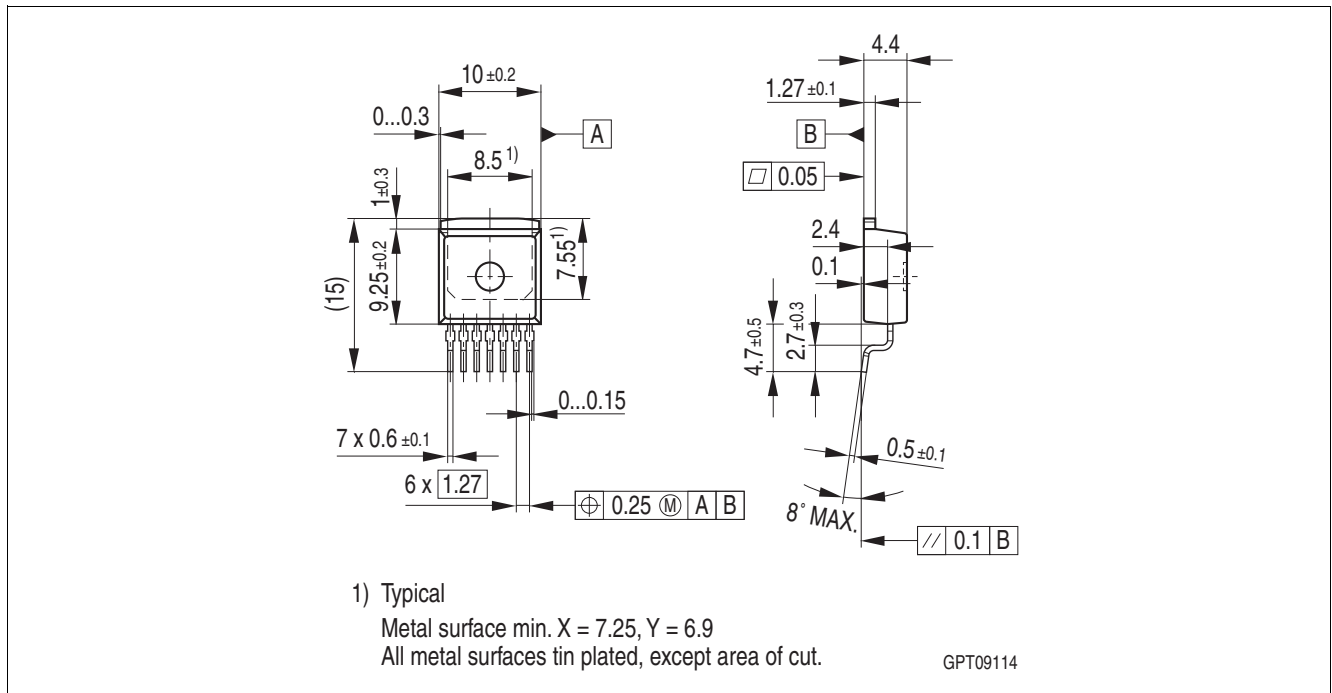

Figure 7 PG-T0263-7 (Plastic transistor single outline)¹⁾

Green Product (RoHS compliant)

To meet the world-wide customer requirements for environmentally friendly products and to be compliant with government regulations the device is available as a green product. Green products are RoHS-Compliant (i.e. Pb-free finish on leads and suitable for Pb-free soldering according to IPC/JEDEC J-STD-020).

Further information on packages

<https://www.infineon.com/packages>

1) Dimensions in mm

Revision history

7 Revision history

Revision	Date	Changes
2.81	2023-07-05	Editorial change (marking on page 1)
2.8	2019-07-30	Deleted both packages: PG-TO-220-7 Updated layout and structure frontpage: updated packaged drawings “TLE4271-2” Editorial changes
2.7	2007-03-20	Initial version of RoHS-compliant derivate of TLE4271-2 Page 1: AEC certified statement added Page 1 and Page 18ff: RoHS compliance statement and Green product feature added Page 1 and Page 18ff: Package changed to RoHS compliant version Legal Disclaimer updated

Trademarks

All referenced product or service names and trademarks are the property of their respective owners.

Edition 2023-07-05

Published by

Infineon Technologies AG

81726 Munich, Germany

© 2023 Infineon Technologies AG.

All Rights Reserved.

Do you have a question about any aspect of this document?

Email: erratum@infineon.com

Document reference

Z8F55216529

IMPORTANT NOTICE

The information given in this document shall in no event be regarded as a guarantee of conditions or characteristics ("Beschaffheitsgarantie").

With respect to any examples, hints or any typical values stated herein and/or any information regarding the application of the product, Infineon Technologies hereby disclaims any and all warranties and liabilities of any kind, including without limitation warranties of non-infringement of intellectual property rights of any third party.

In addition, any information given in this document is subject to customer's compliance with its obligations stated in this document and any applicable legal requirements, norms and standards concerning customer's products and any use of the product of Infineon Technologies in customer's applications.

The data contained in this document is exclusively intended for technically trained staff. It is the responsibility of customer's technical departments to evaluate the suitability of the product for the intended application and the completeness of the product information given in this document with respect to such application.

For further information on technology, delivery terms and conditions and prices, please contact the nearest Infineon Technologies Office (www.infineon.com).

WARNINGS

Due to technical requirements products may contain dangerous substances. For information on the types in question please contact your nearest Infineon Technologies office.

Except as otherwise explicitly approved by Infineon Technologies in a written document signed by authorized representatives of Infineon Technologies, Infineon Technologies' products may not be used in any applications where a failure of the product or any consequences of the use thereof can reasonably be expected to result in personal injury.