

TLSU268G(F), TLRME68TG(F), TLYE68TG(F), TLGE68TG(F)

LED Lamps for mounting on through-hole PCB using an automatic insertion machine

Unit: mm

- Lead(Pb)-free products (lead: Sn-Ag-Cu)
- $\phi 3$ mm wide viewing angle
- Can be mounted on a PCB using an automatic insertion machine (please refer to mounting Precautions Using an Automatic Insertion Machine)
- InGaAlP
- Emitted colors: red, yellow and green
- Transparent lens
- Applications: Various types of information panels, indicators for amusement equipment and panel backlighting illumination sources

Lineup

Product Name	Color	Material
TLSU268G(F)	Red	InGaAlP
TLRME68TG(F)	Red (high-brightness)	
TLYE68TG(F)	Yellow	
TLGE68TG(F)	Green	

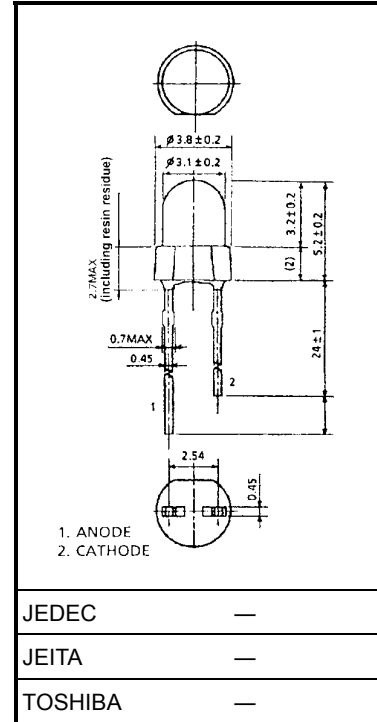

JEDEC	—
JEITA	—
TOSHIBA	—

Weight: 0.15 g

Maximum Ratings (Ta = 25°C)

Product Name	Forward Current I _F (mA)	Reverse Voltage V _R (V)	Power Dissipation P _D (mW)	Operating Temperature T _{opr} (°C)	Storage Temperature T _{stg} (°C)
TLSU268G(F)	30	4	72	-30~85	-40~120
TLRME68TG(F)	50	4	120	-40~100	-40~120
TLYE68TG(F)	50	4	120		
TLGE68TG(F)	50	4	120		

Electrical and Optical Characteristics (Ta = 25°C)

Product Name	Typ. Emission Wavelength				Luminous Intensity I _V			Forward Voltage V _F			Reverse Current I _R	
	λ _d	λ _P	Δλ	I _F	Min	Typ.	I _F	Typ.	Max	I _F	Max	V _R
TLSU268G(F)	623	(636)	17	20	47.6	130	20	2.0	2.4	20	50	4
TLRME68TG(F)	626	(636)	17	20	85	330	20	2.0	2.4	20	50	4
TLYE68TG(F)	587	(590)	17	20	85	340	20	2.0	2.4	20	50	4
TLGE68TG(F)	571	(574)	17	20	47.6	155	20	2.0	2.4	20	50	4
Unit	nm			mA	mcd		mA	V		mA	μA	V

Precautions

- These LED lamps made of InGaAlP will also emit some IR light. If a photodetector is located near an LED lamp, please ensure that it will not be affected by this IR light.
- Manual soldering should be performed within 3 s at a maximum temperature of 300°C or 5 s at a maximum temperature of 260°C.
- When forming the leads, bend each lead without applying any forming stress. Soldering must be performed after the leads have been formed.

Mounting Precautions Using an Automatic Insertion Machine

- (1) These newly designed LED lamps are intended for mounting on both through-hole PCBs by means of an automatic mounting machine. Compared to conventional φ3-mm LED lamps, they are less prone to the effects of stress during automatic mounting (such as mechanical stress within the package resin transmitted via the leads). This reduced mechanical stress results in a lower incidence of damage to the package resin and lower emission failure rates. If one of these lamps is subjected to excessive stress, however, the resin part may break or the lamp may be damaged in such a way that it will not emit light.

Please take the following precautions when mounting these devices.

- Toshiba recommends the use of a 0.9-mm PCB hole diameter. However, this recommendation is subject to the type of automatic mounting machine used, the board material and the way in which the board material has been processed. Please evaluate the mounting process carefully before actually using the automatic mounting machine to mount these LED lamps.

The use of PCB holes with a diameter larger than 0.9 mm may result in increased stress when soldering is performed (depending on the lead cutting shape and the clinching method), and devices may easily be malfunction.

- The insertion pressure and clinching angle must both be minimized so as to minimize the lead-cutting stress and clinch stress applied to the LED lamps.
- Soldering Conditions

	Preheating	Soldering Flow
Temperature	120~150°C	No more than 260°C
Time	Within 60 seconds	Within 5 seconds

- (2) Precautions when using Panasert radial-Taping automatic mounting machine:

Two-lead LED lamps are suitable for mounting using an anvil due to its movable-blade structure.

When using three-lead type, please take the following precautions.

- Synchronize the strokes of the two movable blades to one another as closely as possible.
- Adjust the timings of the movable blades so as to minimize the difference between them. In addition, do not set the anvil in such a way that the anvil's center blade will pull the leads, as this will result in excessive mechanical stress to the LED lamps, which might damage them.
- Avoid any blade which is defective or which shows signs of excessive wear.

* For using other than Panasert, please refer to the specifications for the automatic mounting machine which is to be used.

TLSU268G(F)

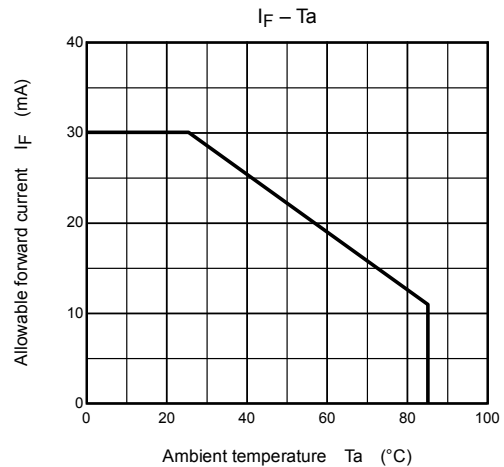
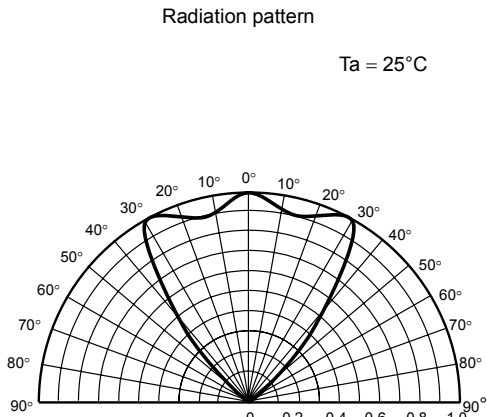
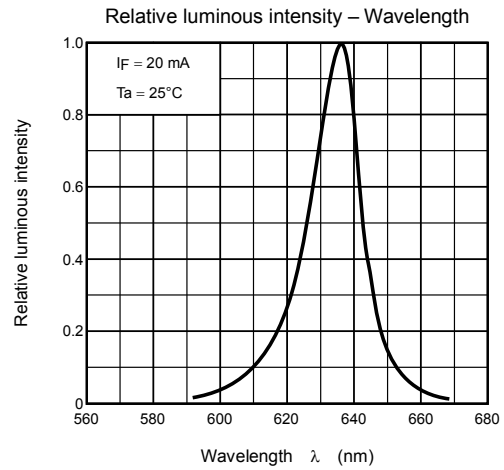
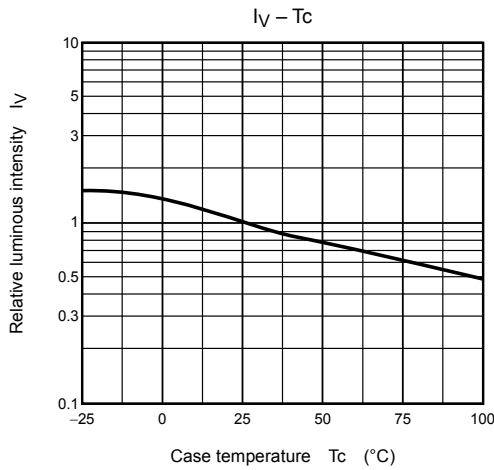
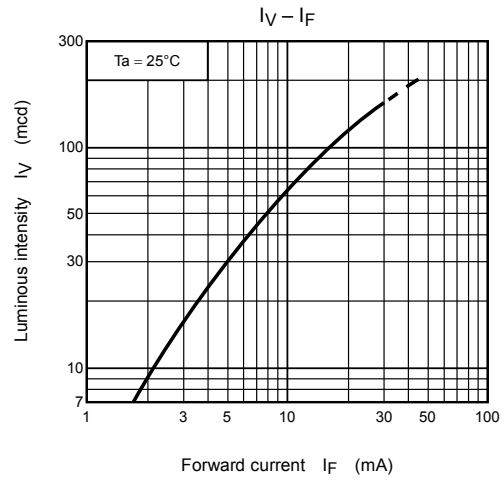
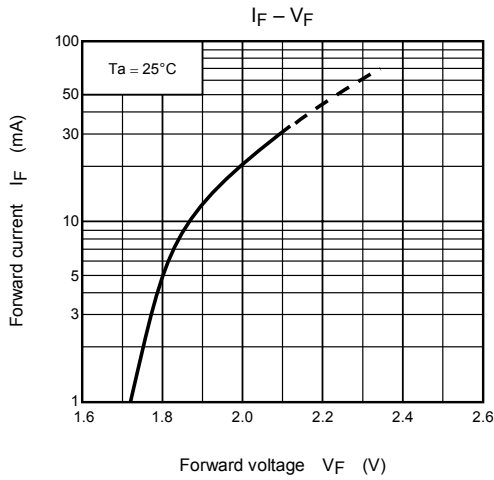

TLRME68TG(F)

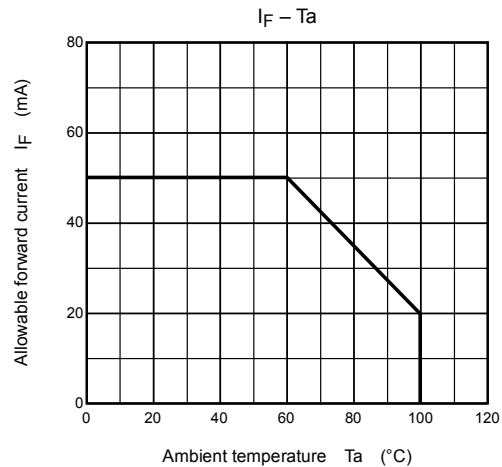
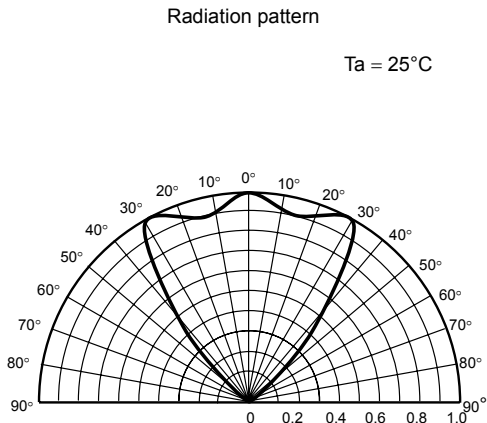
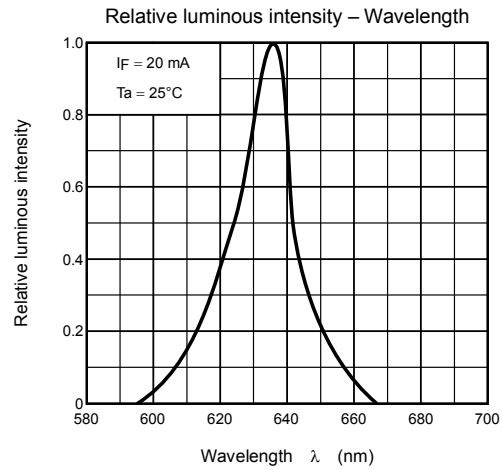
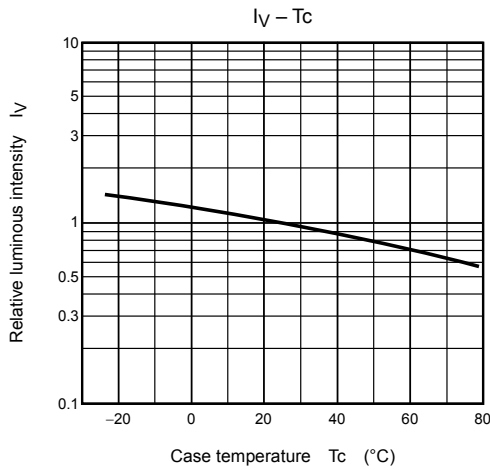
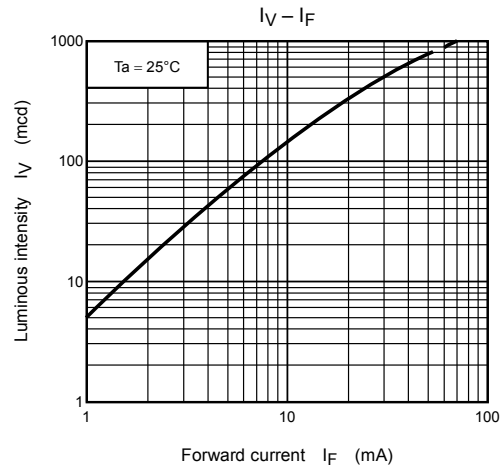
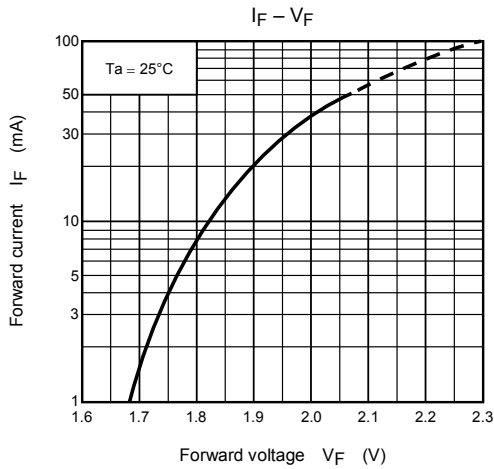

TLYE68TG(F)

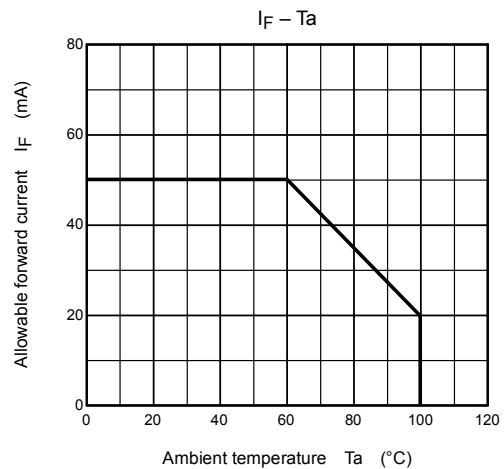
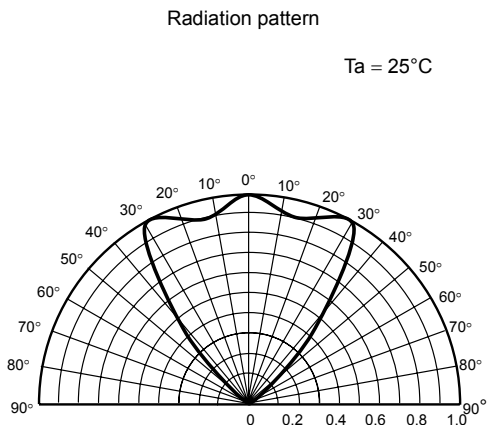
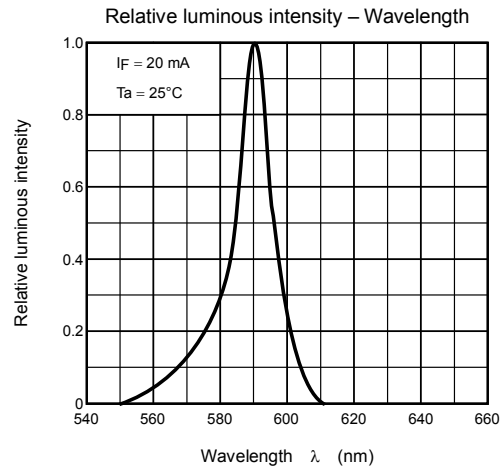
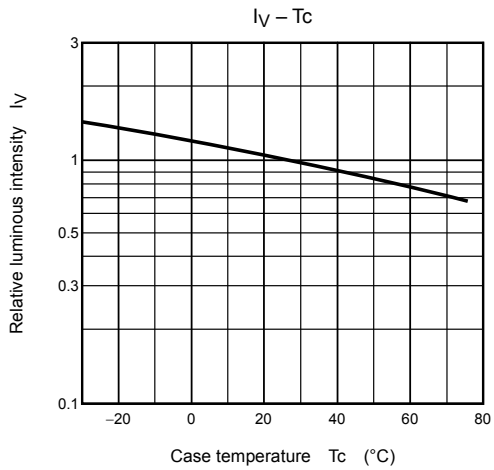
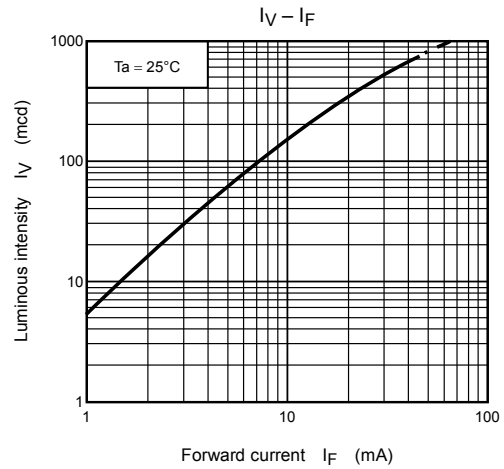
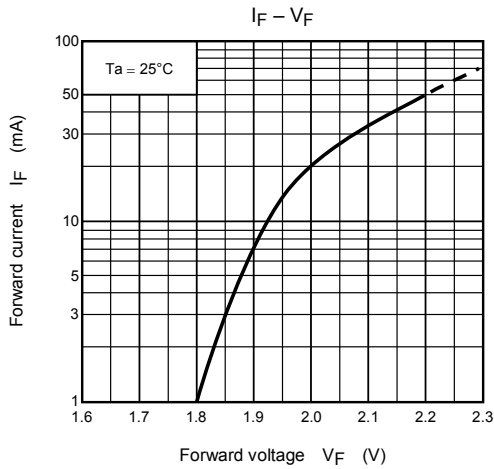

TLGE68TG(F)

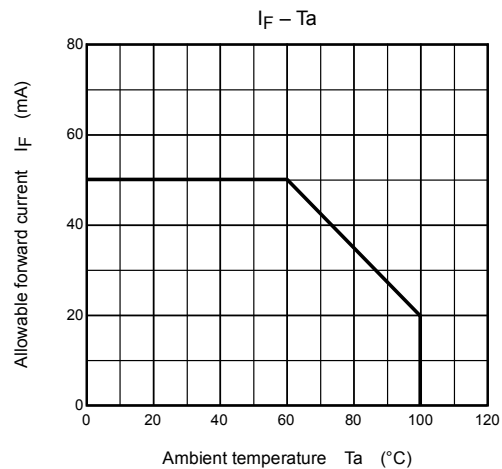
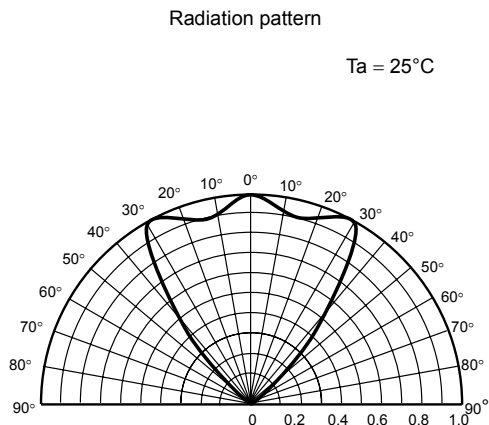
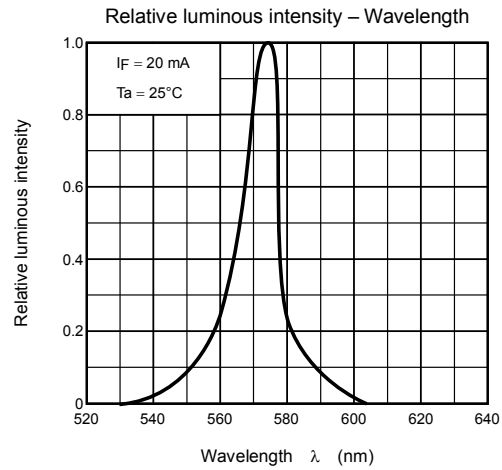
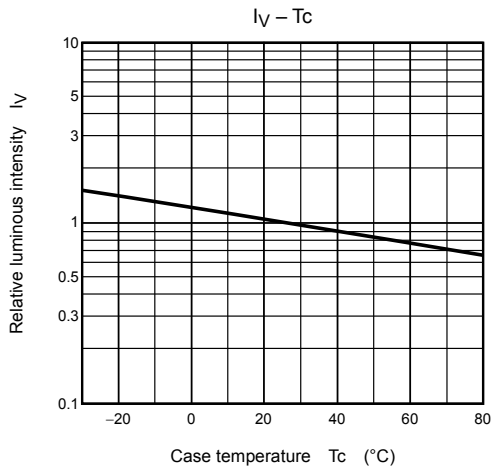
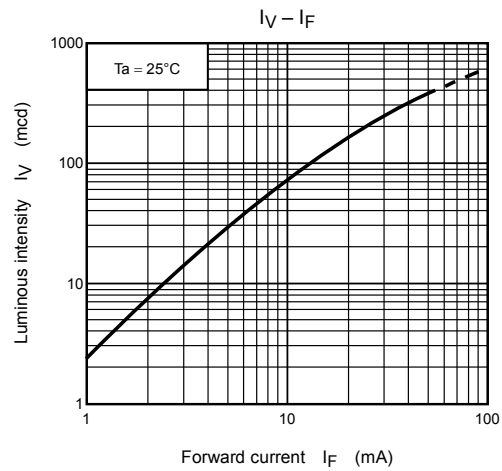
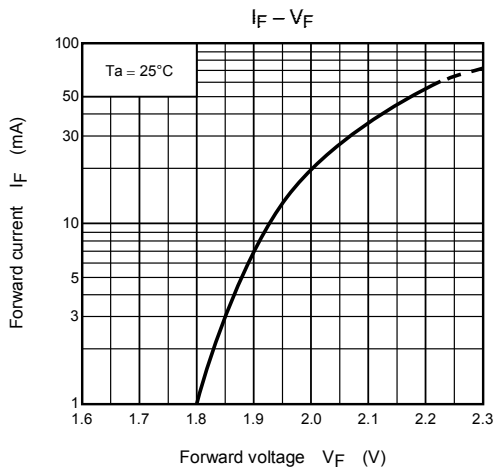

RESTRICTIONS ON PRODUCT USE

030619EAC

- The information contained herein is subject to change without notice.
- The information contained herein is presented only as a guide for the applications of our products. No responsibility is assumed by TOSHIBA for any infringements of patents or other rights of the third parties which may result from its use. No license is granted by implication or otherwise under any patent or patent rights of TOSHIBA or others.
- TOSHIBA is continually working to improve the quality and reliability of its products. Nevertheless, semiconductor devices in general can malfunction or fail due to their inherent electrical sensitivity and vulnerability to physical stress. It is the responsibility of the buyer, when utilizing TOSHIBA products, to comply with the standards of safety in making a safe design for the entire system, and to avoid situations in which a malfunction or failure of such TOSHIBA products could cause loss of human life, bodily injury or damage to property.
In developing your designs, please ensure that TOSHIBA products are used within specified operating ranges as set forth in the most recent TOSHIBA products specifications. Also, please keep in mind the precautions and conditions set forth in the "Handling Guide for Semiconductor Devices," or "TOSHIBA Semiconductor Reliability Handbook" etc..
- The TOSHIBA products listed in this document are intended for usage in general electronics applications (computer, personal equipment, office equipment, measuring equipment, industrial robotics, domestic appliances, etc.). These TOSHIBA products are neither intended nor warranted for usage in equipment that requires extraordinarily high quality and/or reliability or a malfunction or failure of which may cause loss of human life or bodily injury ("Unintended Usage"). Unintended Usage include atomic energy control instruments, airplane or spaceship instruments, transportation instruments, traffic signal instruments, combustion control instruments, medical instruments, all types of safety devices, etc.. Unintended Usage of TOSHIBA products listed in this document shall be made at the customer's own risk.
- TOSHIBA products should not be embedded to the downstream products which are prohibited to be produced and sold, under any law and regulations.
- GaAs(Gallium Arsenide) is used in this product. The dust or vapor is harmful to the human body. Do not break, cut, crush or dissolve chemically.